New York State

**Stormwater
Management
Design Manual**

January 2015

**Originally Prepared by:
Center for Watershed Protection
8391 Main Street
Ellicott City, MD 21043**

**Updated by:
New York State
Department of Environmental Conservation
625 Broadway
Albany, NY 12233**



Acknowledgments

The New York State Stormwater Management Design Manual was prepared under a joint effort between the New York State Department of Environmental Conservation (DEC), the Soil and Water Conservation Committee, and the Central New York Regional Planning and Development Board. Several individuals at these organizations were instrumental in the process of completing this Manual. Don Lake provided the vision to initiate the process, and has been an integral part of its development. Shohreh Karimipour was also indispensable, providing detailed guidance throughout the process and acting as a liaison between the Center for Watershed Protection, the DEC, and several other agencies that commented on the manual. Thanks also to Mike Rafferty, Ken Stevens and Phil DeGaetano who shaped the final outcome of the manual, and provided valuable insight on its potential role in shaping the way stormwater management is conducted in the State of New York.

Additionally, several organizations and other individuals also took the time to review earlier versions of the manual and contributed to the production of this Manual.

Bob Alpern, New York City Dept. of Environmental Protection
Pete Bartell
Toni Cioffi, NYS DEC, DOW, Bureau of Water Permits
Doreen Clemens, Saratoga County SWCD
Thom Engel, NYS DEC, DEP
Pat Ferracane, NYS DEC, Region 3
Eugena Flatlow, NYC SWCD
Matt Gillette, NYS DEC, Region 8
Dave Graves, NYS DOT, Environmental Analysis Bureau
Chad Kehoe, NYS DEC, Region 6
Paul Kieda, NYS DOT
Thilliyambur Manickam, NYS DEC, Region 9
Paul Mankiewicz, Ph.D., GAIA Institute
Robin Marx, Natural Resources Defense Council
Tom McMahon, Suffolk County SWCD
Mindy Moore, Westchester County SWCD
Bill Morton, NYS DEC, DOW, Bureau of Watershed Management
Bill Nechamen, NYS DEC, DOW, Bureau of Flood Protection
Michael Patterson, Environment 21
Paula Smith, Monroe County SWCD
Thomas Snow, NYS DEC
Don Stribick, Erie County SWCD
Don Sweezy, NYS DOT, Region 6
William Wegner, the Riverkeeper

And: the Urban Runoff Workgroup of the Non Point Source Coordinating Committee

Preface

The New York State Stormwater Design Manual is prepared to provide standards for the design of the Stormwater Management Practices (SMPs) to protect the waters of the State of New York from the adverse impacts of urban stormwater runoff. This manual is intended to establish specifications and uniform criteria for the practices that are part of a Stormwater Pollution Prevention Plan (SWPPP).

This manual is intended primarily for engineers and other professionals who are engaged in the design of stormwater treatment facilities for new developments. Users are assumed to have a background in hydrology, hydraulics, and runoff and pollutant load computation. It is not intended to be a primer on any of these subjects. The manual may also be used by reviewing authorities to assess the adequacy of SWPPPs.

The manual is limited to the design of structures. It does not address the temporary control of sedimentation and erosion from construction activities, nor the development of Stormwater Pollution Prevention Plans. The reader is referred to the “*New York State Guidelines for Urban Erosion and Sediment Control*” for erosion and sediment control standards and the “NOI Instruction Manual” for guidance on the development of Stormwater Pollution Prevention Plans.

The Technical Standards, consisting of proven technology, are intended to serve as design criteria for the preparation of plans and specifications for Stormwater Management Practices, to suggest limiting values for items upon which an evaluation of such plans and specifications may be made by the reviewing authority, and to establish, as far as practicable, uniformity of practice. The technical standards constitute discharge technology requirements of the Clean Water Act. As statutory requirements and legal authority pertaining to stormwater management are not uniform across the State, and since conditions and administrative procedures and policies also differ, the use of these Standards must be adjusted to these variations.

The terms “shall” and “must” are used where the practice is sufficiently standardized to permit specific delineation of requirements or where safeguarding of the public health justifies such definite action. Other terms, such as “should,” “recommend,” and “preferred,” indicate desirable procedures or methods, with deviations subject to individual consideration.

New York State Stormwater Management Design Manual

Chapter 1: Introduction to the Manual

Section 1.1 Purpose of the Manual

Chapter 1: Introduction to the Manual

Section 1.1 Purpose of the Manual

The purpose of this manual is threefold:

1. To protect the waters of the State of New York from the adverse impacts of urban stormwater runoff
2. To provide design standards on the most effective stormwater management approaches including:
 - Incorporation of green infrastructure achieved by infiltration, groundwater recharge, reuse, recycle, evaporation/evapotranspiration through the use of green infrastructure techniques as a standard practice
 - Design and implementation of standard stormwater management practices (SMPs)
 - Implementation of a good operation, inspection, and maintenance program
3. To improve the quality of green infrastructure and SMPs constructed in the State, specifically in regard to their performance, longevity, safety, ease of maintenance, community acceptance and environmental benefit

Section 1.2 How to Use the Manual

The *New York State Stormwater Management Design Manual* provides designers a general overview on how to select, locate, size, and design SMPs at a development site to comply with State stormwater performance standards. The manual also contains appendices with more detailed information on landscaping, SMP construction specifications, step-by-step SMP design examples and other assorted design tools. The manual is organized as follows:

Chapter 2. Impacts of New Development

This chapter examines the physical, chemical, and biological effects of unmanaged stormwater runoff on the water quality of local streams and waterbodies. This brief overview provides the background for why the stormwater management manual is needed and how the new criteria will help local communities meet water quality standards.

Chapter 3. Stormwater Management Planning

New York State Stormwater Management Design Manual

Chapter 1: Introduction to the Manual

Section 1.2 How to Use the Manual

This chapter explains the required stormwater management planning process and steps for maintaining preconstruction natural hydrologic conditions of the site by application of environmentally-sound development principles, such as preservation of microtopography, organic soil layers and vegetation, green infrastructure, as well as steps involved in treatment and control of runoff discharges from the site in new development and redevelopment projects.

Chapter 4. Unified Stormwater Sizing Criteria

This chapter explains sizing criteria for water quality, runoff reduction, channel protection, overbank flood control, and extreme flood management in the State of New York. The chapter also outlines the basis for design calculations.

Chapter 5. Green Infrastructure Practices

This chapter provides planning and design criteria on green infrastructure approach and specifications for acceptable runoff reduction practices. This chapter contains the following sections:

4. Green Infrastructure Planning
 - Preservation of Natural Features and Conservation Design
 - Reduction of Impervious Cover
5. Green Infrastructure Techniques

Chapter 6. Performance Criteria

This chapter presents specific performance criteria and design specifications for the design of the five groups of structural SMPs. The performance criteria for each group of SMPs include on six factors:

6. Feasibility
7. Conveyance
8. Pretreatment
9. Treatment
10. Landscaping
11. Maintenance

In addition, the chapter provides guidance on design adjustments that may be required to ensure proper functioning in cold climates.

New York State Stormwater Management Design Manual

Chapter 1: Introduction to the Manual

Section 1.2 How to Use the Manual

Chapter 7. SMP Selection

This chapter presents guidance on how to select the best SMP or group of practices at a development site, as well as environmental and other factors to consider when actually locating each SMP. The chapter contains five comparative matrices that evaluate SMPs based on the following factors:

12. Land Use

13. Physical Feasibility

14. Watershed /Regional Factors

15. Stormwater Management Capability

16. Community and Environmental Factors

Chapter 7 is designed so that the reader can use the matrices in a step-wise fashion to identify the most appropriate SMP or group of practices to use at a site.

Chapter 8. Stormwater Management Design Examples

Design examples are provided to help designers and plan reviewers better understand the new criteria in this manual. The step-by-step design examples demonstrate how the new stormwater sizing criteria are applied, and some of the design procedures and performance criteria that should be considered when planning a new stormwater management practice.

Chapter 9. Redevelopment Projects

This chapter outlines alternative approaches to stormwater management for redevelopment projects. The approaches defines application criteria, sizing criteria, and performance criteria set forth for compliance with the Department's technical standards.

Chapter 10. Enhanced Phosphorus Removal Supplement

This chapter addresses design standards for "enhanced phosphorus removal" for projects in phosphorus-limited watersheds. To meet water quality objectives the enhanced phosphorus removal standards define the sizing criteria, the use of upstream controls as a primary means for reducing runoff volumes, and details on enhanced performance criteria.

Stormwater Design Appendices

New York State Stormwater Management Design Manual

Chapter 1: Introduction to the Manual

Section 1.2 How to Use the Manual

The appendices contain the technical information needed to actually design, landscape and construct an SMP. There are a total of thirteen appendices:

Appendix A. Guidelines for Design of Dams

This appendix provides the general guidelines that New York State Department of Environmental Conservation offers the design engineers on the design of dams. These guidelines represent professional judgment and sound engineering practices for small dams in an average situation. These guidelines are not applicable if unusual conditions exist.

Appendix B. Design Tools

The accurate calculation of stormwater flows may require modifications to some methods to account for small storm hydrology. This appendix provides methodologies to calculate the storage requirements for the channel protection flow event, and a methodology to calculate the peak flow from the small water quality storm.

Appendix C. SMP Construction Specifications

Good designs only work if careful attention is paid to proper construction techniques and materials. Appendix C contains detailed specifications for constructing ponds, infiltration practices, filters, bioretention areas and open channels.

Appendix D. Infiltration Testing

This appendix describes methodologies to test soil infiltration rates, in order to determine if infiltration is an acceptable option on site.

Appendices E-G. Checklists

These three appendices provide example checklists that can be used to assist in the plan review, construction, and operation and maintenance of an SMP.

Appendix H. Landscaping Guidance

Good landscaping can often be an important factor in the performance and community acceptance of stormwater SMPs. Appendix H also includes tips on how to establish more functional landscapes within

New York State Stormwater Management Design Manual

Chapter 1: Introduction to the Manual

Section 1.3 Symbols and Acronyms

stormwater SMPs, and contains an extensive list of trees, shrubs, ground covers, and wetland plants that can be used to develop an effective and diverse planting plan.

Appendix I. Cold Climate Sizing Example

This appendix supplies guidance on sizing SMPs to account for cold climate conditions that might hamper performance. Example sizing designs that illustrate how to incorporate cold climate criteria into SMP design are also included.

Appendix J. Geomorphic Assessment

This appendix provides a description of the Distributed Runoff Control (DRC) methodology to size stormwater practices based on downstream geomorphic characteristics.

Appendix K. Miscellaneous Details

The designs of various structures previously discussed in the manual are presented in Appendix K. These structures help enhance the performance of stormwater management practices, especially in cold climates. Schematics of structures such as weirs, trash racks, and observation wells are included.

Appendix L. Critical Erosive Velocities

This appendix provides data on critical erosive velocities for soil and grasses.

Section 1.3 Symbols and Acronyms

As an aid to the reader, Table 1.1 outlines the symbols and acronyms that are used throughout the text. In addition, a glossary is provided at the end of this volume that defines the terminology used in the text.

Table 1.1 Key Symbols and Acronyms Cited in Manual

Symbol	Definition	Symbol	Definition
A	drainage area	Q _f	extreme flood storage volume
A _f	filter bed area	Q _i	peak inflow discharge
A _s	surface area, sedimentation basin	Q _o	peak outflow discharge
A _i	impervious area for runoff reduction	Q _p	overbank flood control storage volume

New York State Stormwater Management Design Manual

Chapter 1: Introduction to the Manual

Section 1.3 Symbols and Acronyms

Table 1.1 Key Symbols and Acronyms Cited in Manual

Aic	total area of impervious cover	qp	water quality peak discharge
cfs	cubic feet per second	qu	unit peak discharge
Cpv	channel protection storage volume	SMP	stormwater management practice
CMP	corrugated metal pipe	Rv	volumetric runoff coefficient
CN	curve number	R/W	right of way
Cpv-ED	extended detention of the 1 year post-development runoff	RRv	runoff reduction volume
df	depth of filter bed	S	Specific reduction factor
du	dwelling units	SD	separation distance
DOT	Department of Transportation	SPDES	State Pollutant Discharge Elimination System
DPW	Department of Public Works	tc	time of concentration
ED	extended detention	tt	time to drain filter bed
fc	soil infiltration rate	TR-20	Technical Release No. 20 Project Formulation-Hydrology, computer program
fps	feet per second	TR-55	Technical Release No. 55 Urban Hydrology for Small Watersheds
h _f	head above filter bed	TSS	total suspended solids
HSG	hydrologic soil group	V _r	volume of runoff
I _a	initial abstraction	V _s	volume of storage
I	percent impervious cover	V _t	total volume
K	coefficient of permeability		volume of voids

New York State Stormwater Management Design Manual

Chapter 1: Introduction to the Manual

Section 1.3 Symbols and Acronyms

Table 1.1 Key Symbols and Acronyms Cited in Manual

		V _v	
NYSDEC	New York State Department of Environmental Conservation	WQ _v	water quality storage volume
NRCS	Natural Resources Conservation Service	WQ _v -ED	12 or 24 hour extended detention of the water quality volume
P	precipitation depth	WSEL	water surface elevation

Chapter 2: Impacts of New Development

Urban development has a profound influence on the quality of New York’s waters. To start, development dramatically alters the local hydrologic cycle (see Figure 2.1). The hydrology of a site changes during the initial clearing and grading that occur during construction. Trees that had intercepted rainfall are removed, and natural depressions that had temporarily ponded water are graded to a uniform slope. The spongy humus layer of the forest floor that had absorbed rainfall is scraped off, eroded or severely compacted. Having lost its natural storage capacity, a cleared and graded site can no longer prevent rainfall from being rapidly converted into stormwater runoff.

Figure 2.1 Water Balance at a Developed and Undeveloped Site (Schueler, 1987)

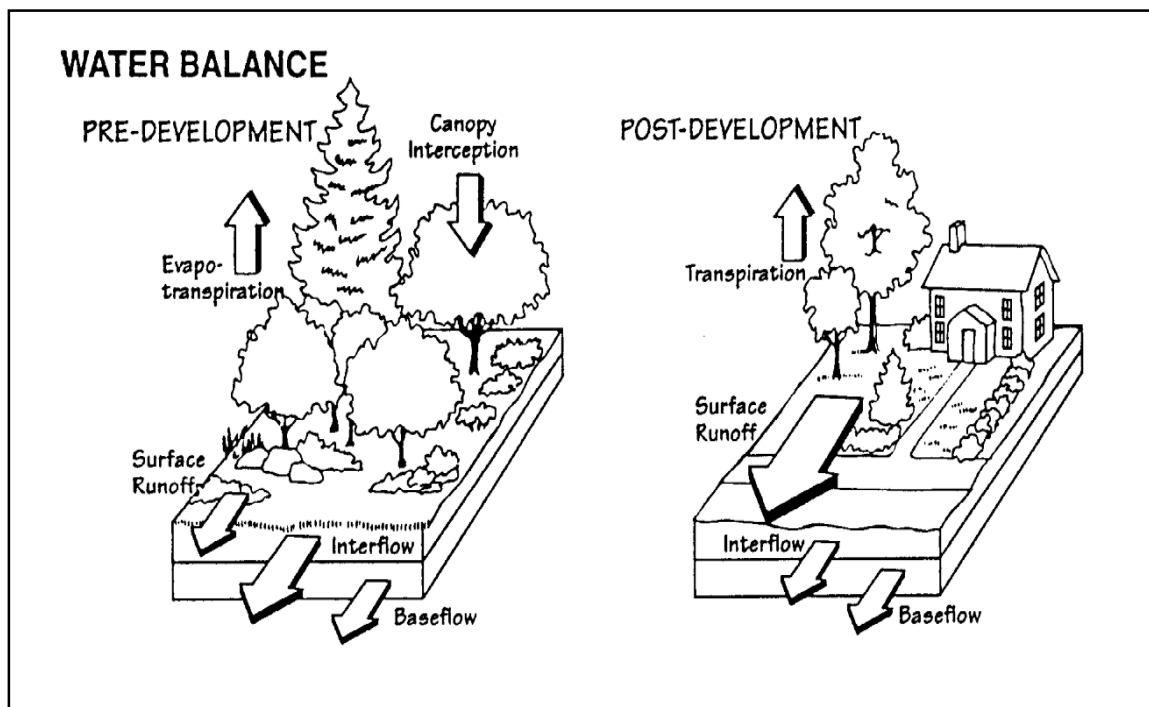

The situation worsens after construction. Rooftops, roads, parking lots, driveways and other impervious surfaces no longer allow rainfall to soak into the ground. Consequently, most rainfall is directly converted into stormwater runoff. This phenomenon is illustrated in Figure 2.2, which shows the increase in the volumetric runoff coefficient (R_v) as a function of site imperviousness. The runoff coefficient expresses the fraction of rainfall volume that is converted into stormwater runoff. As can be seen, the volume of stormwater runoff increases sharply with impervious cover. For example, a one-acre parking lot can produce 16 times more stormwater runoff than a one-acre meadow each year (Schueler, 1994).

New York State Stormwater Management Design Manual

Chapter 2: Impacts of New Development

Section 2.1 Declining Water Quality

The increase in stormwater runoff can be too much for the existing drainage system to handle. As a result, the drainage system is often “improved” to rapidly collect runoff and quickly convey it away (using curb and gutter, enclosed storm sewers, and lined channels). The stormwater runoff is subsequently discharged to downstream waters, such as streams, reservoirs, lakes or estuaries.

Figure 2.2 Relationship Between Impervious Cover and Runoff Coefficient (Schueler, 1987)

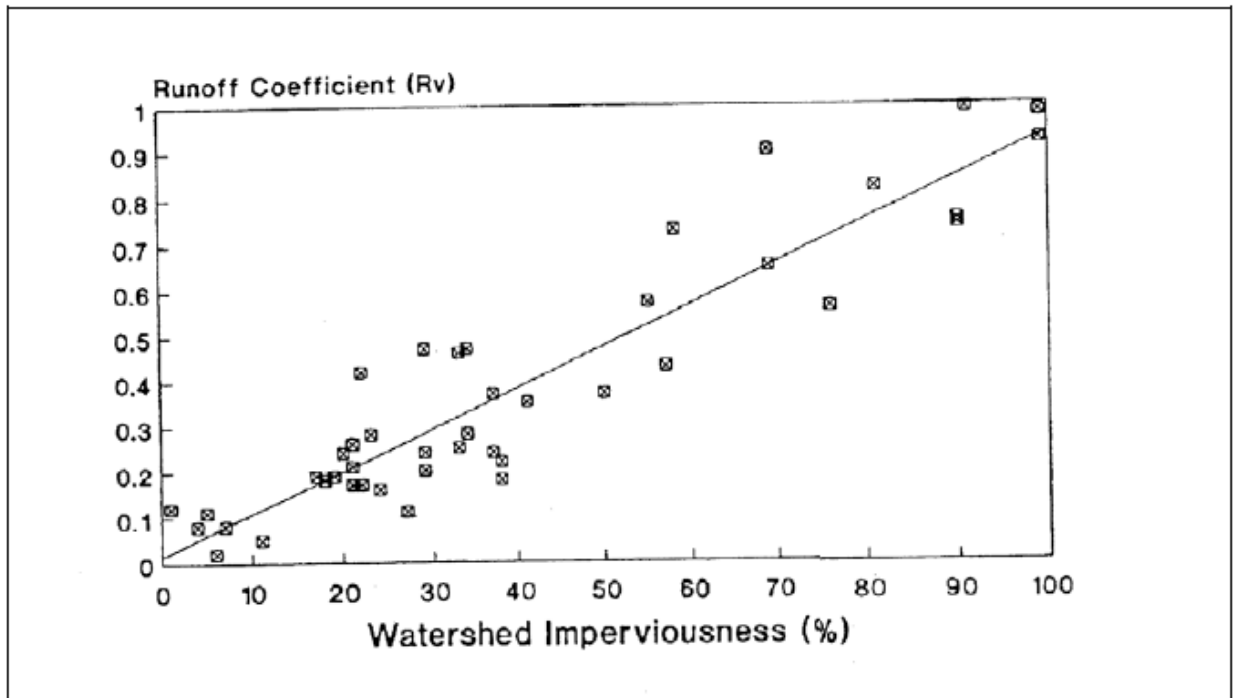

Section 2.1 Declining Water Quality

Impervious surfaces accumulate pollutants deposited from the atmosphere, leaked from vehicles, or windblown in from adjacent areas. During storm events, these pollutants quickly wash off, and are rapidly delivered to downstream waters. Some common pollutants found in urban stormwater runoff are profiled in Table 2.1.

Sediment (Suspended Solids)

Sources of sediment include washoff of particles that are deposited on impervious surfaces and erosion from streambanks and construction sites. Streambank erosion is a particularly important source of sediment, and some studies suggest that streambank erosion accounts for up to 70% of the sediment load in urban watersheds (Trimble, 1997).

New York State Stormwater Management Design Manual

Chapter 2: Impacts of New Development

Section 2.1 Declining Water Quality

Table 2.1 National Median Concentrations for Chemical Constituents in Stormwater		
Constituent	Units	Concentration
Total Suspended Solids ¹	mg/l	54.5
Total Phosphorus ¹	mg/l	0.26
Soluble Phosphorus ¹	mg/l	0.10
Total Nitrogen ¹	mg/l	2.00
Total Kjeldhal Nitrogen ¹	mg/l	1.47
Nitrite and Nitrate ¹	mg/l	0.53
Copper ¹	ug/l	11.1
Lead ¹	ug/l	50.7
Zinc ¹	ug/l	129
BOD ¹	mg/l	11.5
COD ¹	mg/l	44.7
Organic Carbon ²	mg/l	11.9
PAH ³	mg/l	3.5*
Oil and Grease ⁴	mg/l	3.0*
Fecal Coliform ⁵	col/100 ml	15,000*
Fecal Strep ⁵	col/ 100 ml	35,400*
Chloride (snowmelt) ⁶	mg/l	116

New York State Stormwater Management Design Manual

Chapter 2: Impacts of New Development

Section 2.1 Declining Water Quality

* Represents a Mean Value

Source:

- 1: Pooled NURP/USGS (Smullen and Cave, 1998)
- 2: Derived from the National Pollutant Removal Database (Winer, 2000)
- 3: Rabanal and Grizzard 1995
- 4: Crunkilton et al. (1996)
- 5: Schueler (1999)
- 6: Oberts 1994

Both suspended and deposited sediments can have adverse effects on aquatic life in streams, lakes and estuaries. Turbidity resulting from sediment can reduce light penetration for submerged aquatic vegetation critical to estuary health. In addition, the reflected energy from light reflecting off of suspended sediment can increase water temperatures (Kundell and Rasmussen, 1995). Sediment can physically alter habitat by destroying the riffle-pool structure in stream systems, and smothering benthic organisms such as clams and mussels. Finally, sediment transports many other pollutants to the water resource.

Nutrients

Runoff from developed land has elevated concentrations of both phosphorus and nitrogen, which can enrich streams, lakes, reservoirs and estuaries. This process is known as eutrophication. Significant sources of nitrogen and phosphorus include fertilizer, atmospheric deposition, animal waste, organic matter, and stream bank erosion. Another nitrogen source is fossil fuel combustion from automobiles, power plants and industry. Data from the upper Midwest suggest that lawns are a significant contributor, with concentrations as much as four times higher than other land uses, such as streets, rooftops, or driveways (Steuer *et al.*, 1997; Waschbusch *et al.*, 2000; Bannerman *et al.*, 1993).

Nutrients are of particular concern in lakes and estuaries, and are a source of degradation in many of New York's waters. Nitrogen has contributed to hypoxia in the Long Island Sound, and is a key pollutant of concern in the New York Harbor and the Peconic Estuary. Phosphorus in runoff has impacted the quality of a number of New York natural lakes, including the Finger Lakes and Lake Champlain, which are susceptible to eutrophication from phosphorus loading. Phosphorus has been identified as a key parameter in the New York City Reservoir system. The New York City DEP recently developed water quality guidance values for phosphorus for City drinking water reservoirs (NYC DEP, 1999); a source-water phosphorus guidance value

New York State Stormwater Management Design Manual

Chapter 2: Impacts of New Development

Section 2.1 Declining Water Quality

of 15 µg/l has been proposed for seven reservoirs (Kensico, Rondout, Ashokan, West Branch, New Croton, Croton Falls, and Cross River) in order to protect them from use-impairment due to eutrophication, with other reservoirs using the State recommended guidance value of 20 µg/l.

Organic Carbon

Organic matter, washed from impervious surfaces during storms, can present a problem in slower moving downstream waters. Some sources include organic material blown onto the street surface, and attached to sediment from stream banks, or from bare soil. In addition, organic carbon is formed indirectly from algal growth within systems with high nutrient loads.

As organic matter decomposes, it can deplete dissolved oxygen in lakes and tidal waters. Declining levels of oxygen in the water can have an adverse impact on aquatic life. An additional concern is the formation of trihalomethane (THM), a carcinogenic disinfection by-product, due to the mixing of chlorine with water high in organic carbon. This is of particular importance in unfiltered water supplies, such as the New York City Reservoir System.

Bacteria

Bacteria levels in stormwater runoff routinely exceed public health standards for water contact recreation. Some stormwater sources include pet waste and urban wildlife. Other sources in developed land include sanitary and combined sewer overflows, wastewater, and illicit connections to the storm drain system. Bacteria is a leading contaminant in many of New York's waters, and has led to shellfish bed closures in the New York Bight Area, on Long Island, and in the Hudson-Raritan Estuary. In addition, Suffolk, Nassau, and Erie Counties issue periodic bathing-beach advisories each time a significant rainfall event occurs (NRDC, 2000).

Hydrocarbons

Vehicles leak oil and grease that contain a wide array of hydrocarbon compounds, some of which can be toxic to aquatic life at low concentrations. Sources are automotive, and some areas that produce runoff with high runoff concentrations include gas stations, commuter parking lots, convenience stores, residential parking areas, and streets (Schueler, 1994).

Trace Metals

New York State Stormwater Management Design Manual

Chapter 2: Impacts of New Development

Section 2.1 Declining Water Quality

Cadmium, copper, lead and zinc are routinely found in stormwater runoff. Many of the sources are automotive. For example, one study suggests that 50% of the copper in Santa Clara, CA comes from brake pads (Woodward-Clyde, 1992). Other sources of metals include paints, road salts, and galvanized pipes.

These metals can be toxic to aquatic life at certain concentrations, and can also accumulate in the bottom sediments of lakes and estuaries. Specific concerns in aquatic systems include bioaccumulations in fish and macro-invertebrates, and the impact of toxic bottom sediments on bottom-dwelling species.

Pesticides

A modest number of currently used and recently banned insecticides and herbicides have been detected in urban and suburban streamflow at concentrations that approach or exceed toxicity thresholds for aquatic life. Key sources of pesticides include application to urban lawns and highway median and shoulder areas.

Chlorides

Salts that are applied to roads and parking lots in the winter months appear in stormwater runoff and meltwater at much higher concentrations than many freshwater organisms can tolerate. One study of four Adirondack streams found severe impacts to macroinvertebrate species attributed to chlorides (Demers and Sage, 1990). In addition to the direct toxic effects, chlorides can impact lake systems by altering their mixing cycle. In 1986, incomplete mixing in the Irondequoit Bay was attributed to high salt use in the region (MCEMC, 1987). A primary source of chlorides in New York State, particularly in the State's northern regions, is salt applied to road surfaces as a deicer.

Thermal Impacts

Runoff from impervious surfaces may increase temperature in receiving waters, adversely impacting aquatic organisms that require cold and cool water conditions (e.g., trout). Data suggest that increasing development can increase stream temperatures by between five and twelve degrees Fahrenheit, and that the increase is related to the level of impervious cover in the drainage area (Galli, 1991). Thermal impacts are a serious concern in trout waters, where cold temperatures are critical to species survival.

Trash and Debris

Considerable quantities of trash and debris are washed through the storm drain networks. The trash and debris accumulate in streams and lakes and detract from their natural beauty. Depending on the type of trash, this material may also lead to increased organic matter or toxic contaminants in water bodies.

New York State Stormwater Management Design Manual

Chapter 2: Impacts of New Development

Section 2.1 Declining Water Quality

Snowmelt Concentrations

The snow pack can store hydrocarbons, oil and grease, chlorides, sediment, and nutrients. In cold regions, the pollutant load during snowmelt can be significant, and chemical traits of snowmelt change over the course of the melt event. Oberts (1994) studied this phenomenon, and describes four types of snowmelt runoff (Table 2.2). Oberts and others have reported that 90% of the hydrocarbon load from snowmelt occurs during the last 10% of the event. From a practical standpoint, the high hydrocarbon loads experienced toward the end of the season suggest that stormwater management practices should be designed to capture as much of the snowmelt event as possible.

New York State Stormwater Management Design Manual

Chapter 2: Impacts of New Development

Section 2.2 Diminishing Groundwater Recharge and Quality

Table 2.2 Runoff and Pollutant Characteristics of Snowmelt Stages (Oberts, 1994)

Snowmelt Stage	Duration/ Frequency	Runoff Volume	Pollutant Characteristics
Pavement Melt	Short, but many times in winter	Low	Acidic, high concentrations of soluble pollutants, Cl, nitrate, lead. Total load is minimal.
Roadside Melt	Moderate	Moderate	Moderate concentrations of both soluble and particulate pollutants.
Pervious Area Melt	Gradual, often most at end of season	High	Dilute concentrations of soluble pollutants, moderate to high concentrations of particulate pollutants, depending on flow.
Rain-on-Snow Melt	Short	Extreme	High concentrations of particulate pollutants, moderate to high concentrations of soluble pollutants. High total load.

Section 2.2 Diminishing Groundwater Recharge and Quality

The slow infiltration of rainfall through the soil layer is essential for replenishing groundwater. Groundwater is a critical water resource across the State. Not only do many residents depend on groundwater for their drinking water, but the health of many aquatic systems is also dependent on its steady discharge. For example, during periods of dry weather, groundwater sustains flows in streams and helps to maintain the hydrology of non-tidal wetlands.

Because development creates impervious surfaces that prevent natural recharge, a net decrease in groundwater recharge rates can be expected in urban watersheds. Thus, during prolonged periods of dry

New York State Stormwater Management Design Manual

Chapter 2: Impacts of New Development

Section 2.2 Diminishing Groundwater Recharge and Quality

weather, streamflow sharply diminishes. Another source of diminishing baseflow is well drawdowns as populations increase in the watershed. In smaller headwater streams, the decline in stream flow can cause a perennial stream to become seasonally dry. One study in Long Island suggests that the supply of baseflow decreased in some developing watersheds, particularly where the water supply was sewered (Spinello and Simmons, 1992; Figure 2.3).

Urban land uses and activities can also degrade *groundwater quality*, if stormwater runoff is infiltrated without adequate treatment. Certain land uses and activities are known to produce higher loads of metals and toxic chemicals and are designated as *stormwater hotspots*. Soluble pollutants, such as chloride, nitrate, copper, dissolved solids and some polycyclic aromatic hydrocarbons (PAH's) can migrate into groundwater and potentially contaminate wells. Stormwater runoff from designated hotspots should never be infiltrated, unless the runoff receives full treatment with another practice.

Figure 2.3 Declining Baseflow in Response to Development

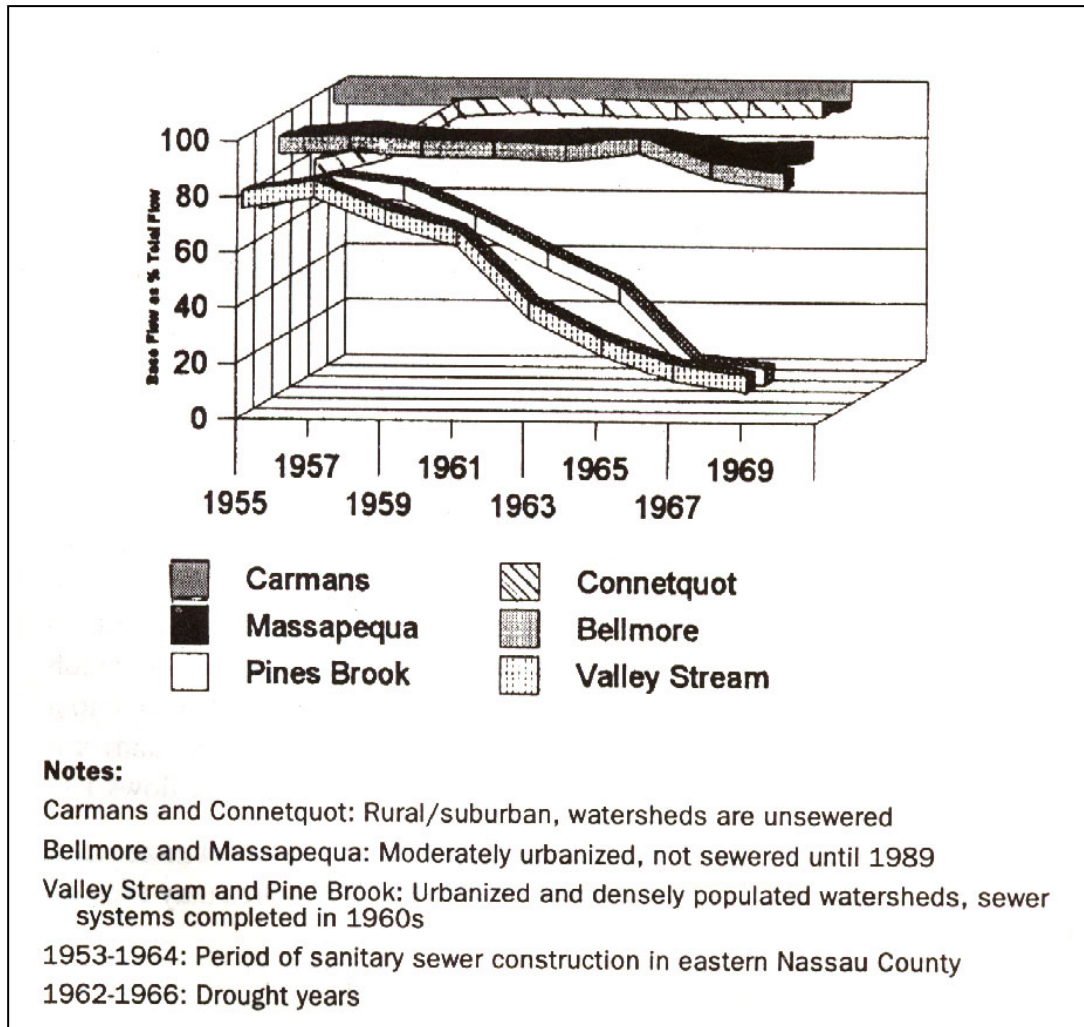

Section 2.3 Impacts to the Stream Channel

As pervious meadows and forests are converted into less pervious urban soils, or pavement, both the frequency and magnitude of storm flows increase dramatically. As a result, the bankfull event occurs two to seven times more frequently after development occurs (Leopold, 1994). In addition, the discharge associated with the original bankfull storm event can increase by up to five times (Hollis, 1975). As Figure 2.4 demonstrates, the total flow beyond the “critical erosive velocity” increases substantially after development

New York State Stormwater Management Design Manual

Chapter 2: Impacts of New Development

Section 2.3 Impacts to the Stream Channel

Figure 2.4 Increased Frequency of Erosive Flow After Development

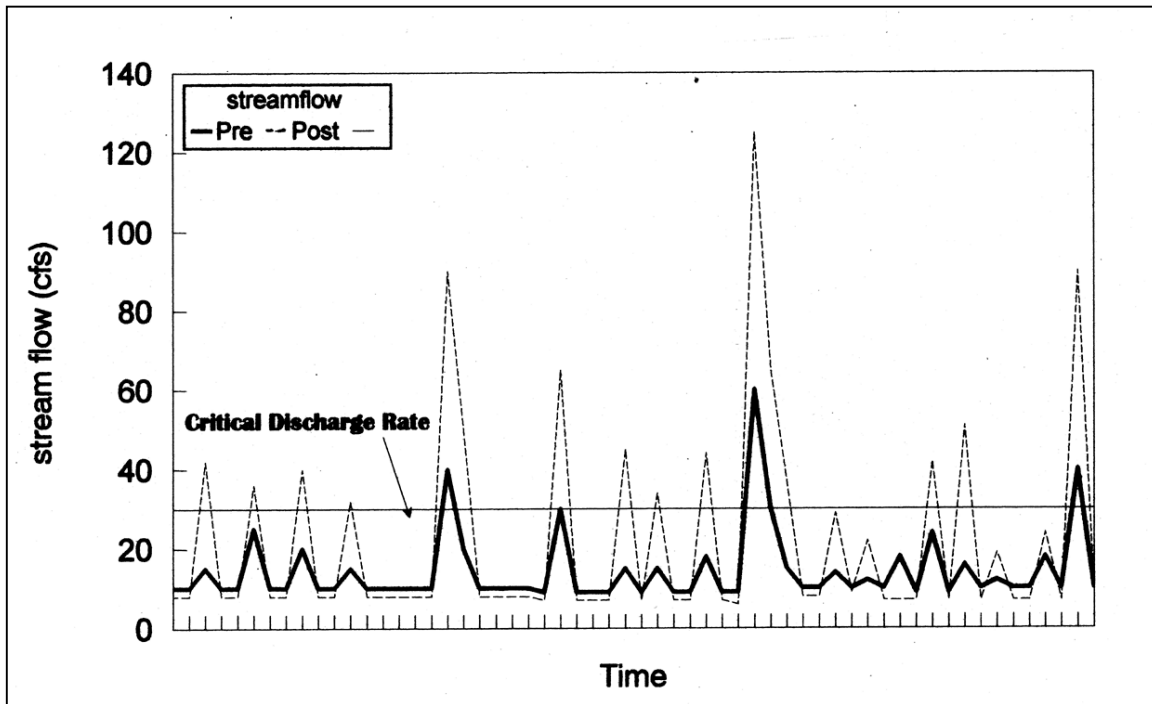

occurs. The increased energy resulting from these more frequent bankfull flow events results in erosion and enlargement of the stream channel, and consequent habitat degradation.

Channel enlargement in response to watershed development has been observed for decades, with research indicating that the stream channel area expands to between two and five times its original size in response to upland development (Hammer, 1972; Morisawa and LaFlure, 1979; Allen and Narramore, 1985; Booth, 1990). One researcher developed a direct relationship between the level of impervious cover and the “ultimate” channel enlargement, the area a stream will eventually reach over time (MacRae, 1996; Figure 2.5).

New York State Stormwater Management Design Manual

Chapter 2: Impacts of New Development

Section 2.3 Impacts to the Stream Channel

Historically, New York has used two-year control (i.e., reduction of the peak flow from the two-year storm to predeveloped levels) to prevent channel erosion, as required in the 1993 SPDES General Permit (GP-93-06). Research suggests that this measure does not adequately protect stream channels (McCuen and Moglen, 1988, MacRae, 1996). Although the peak flow is lower, it is also extended over a longer period of time, thus increasing the duration of erosive flows. In addition, the bankfull flow event actually becomes more frequent after development occurs. Consequently, capturing the two-year event may not address the channel-forming event.

This stream channel erosion and expansion, combined with direct impacts to the stream system, act to decrease the habitat quality of the stream. The stream will thus experience the following impacts to habitat

Figure 2.5 Relationship Between Impervious Cover and Channel Enlargement

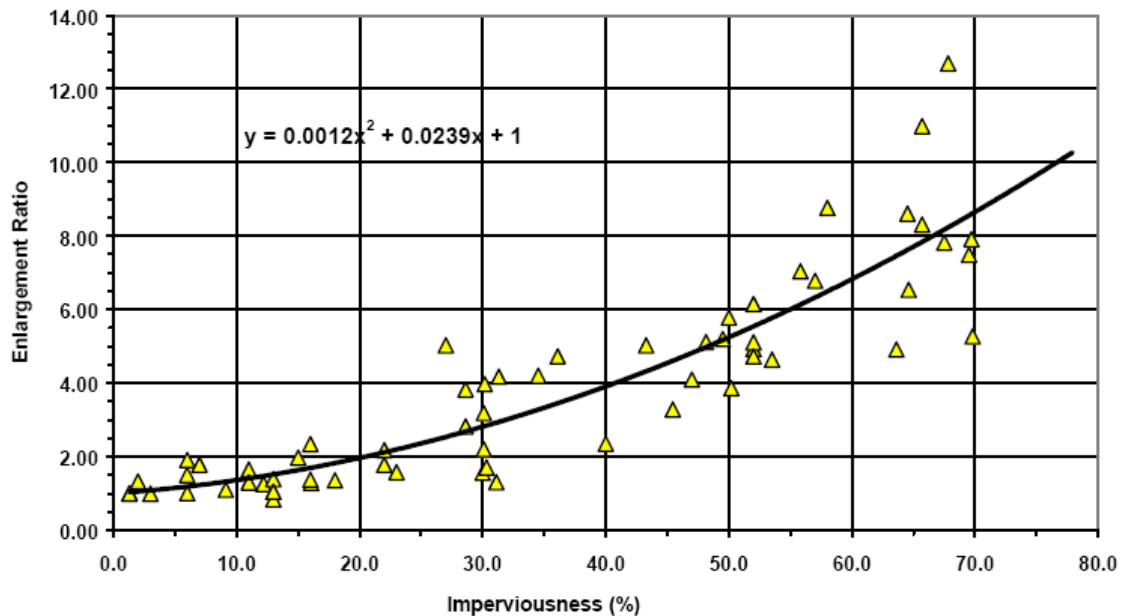

(Table 2.3):

- Decline in stream substrate quality (through sediment deposition and embedding of the substrate)
- Loss of pool/riffle structure in the stream channel
- Degradation of stream habitat structure
- Creation of fish barriers by culverts and other stream crossings
- Loss of “large woody debris,” which is critical to fish habitat

New York State Stormwater Management Design Manual

Chapter 2: Impacts of New Development

Section 2.4 Increased Overbank Flooding

Table 2.3 Impacts to Stream Habitat			
Stream Channel Impact	Key Finding	Reference	Year
<i>Habitat Characteristics</i>			
Embeddedness	Interstitial spaces between substrate fill with increasing watershed imperviousness	Horner <i>et al.</i>	1996
Large Woody Debris (LWD)	Important for habitat diversity and anadromous fish.	Spence <i>et al.</i>	1996
	Decreased LWD with increases in imperviousness	Booth <i>et al.</i>	1996
Changes in Stream Features	Altered pool/riffle sequence with urbanization	Richey	1982
	Loss of habitat diversity	Scott <i>et al.</i>	1986
<i>Direct Channel Impacts</i>			
Reduction in 1 st Order Streams	Replaced by storm drains and pipes increases erosion rate downstream	Dunne and Leopold	1972
Channelization and hardening of stream channels	Increase instream velocities often leading to increased erosion rates downstream	Sauer <i>et al.</i>	1983
Fish Blockages	Fish blockages caused by bridges and culverts	MWCOG	1989

Section 2.4 Increased Overbank Flooding

Flow events that exceed the capacity of the stream channel spill out into the adjacent floodplain. These are termed “overbank” floods, and can damage property and downstream structures. While some overbank flooding is inevitable and sometimes desirable, the historical goal of drainage design in New York has been to maintain pre-development peak discharge rates for both the two- and ten-year frequency storm after

New York State Stormwater Management Design Manual

Chapter 2: Impacts of New Development

Section 2.4 Increased Overbank Flooding

Figure 2.6 Hydrographs Before and After Development

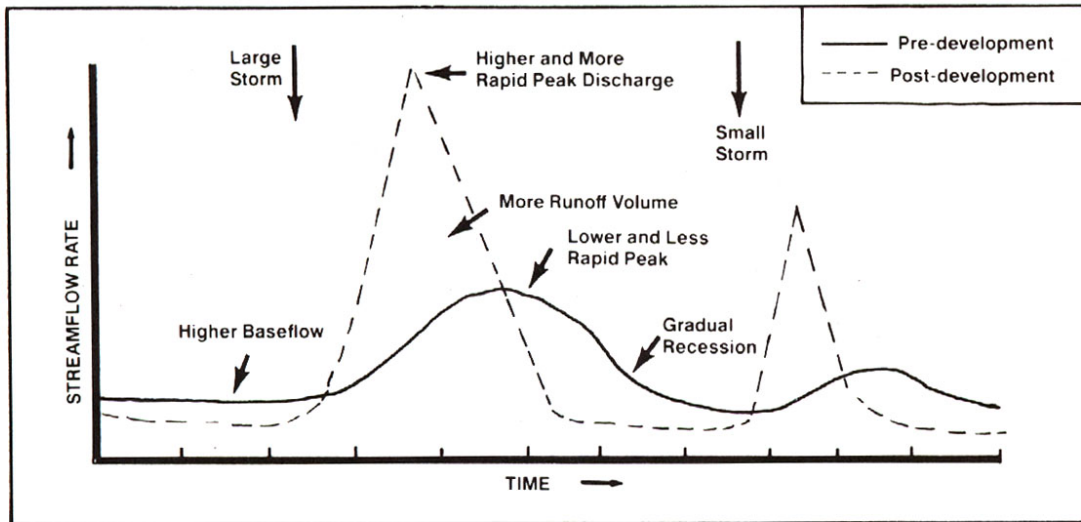

development, thus keeping the level of overbank flooding the same over time. This management technique prevents costly damage or maintenance for culverts, drainage structures, and swales.

Overbank floods are ranked in terms of their statistical return frequency. For example, a flood that has a 50% chance of occurring in any given year is termed a “two-year” flood. The two-year event is also known as the “bankfull flood,” as researchers have demonstrated that most natural stream channels in the State have just enough capacity to handle the two-year flood before spilling out into the floodplain. Although many factors, such as soil moisture, topography, and snowmelt, can influence the magnitude of a particular flood event, designers typically design for the “two-year” storm event. In New York State, the two-year design storm ranges between about 2.0 to 4.0 inches of rain in a 24-hour period. Similarly, a flood that has a 10% chance of occurring in any given year is termed a “ten-year flood.” A ten-year flood occurs when a storm event produces between 3.2 and 6.0 inches of rain in a 24-hour period. Under traditional engineering practice, most channels and storm drains in New York are designed with enough capacity to safely pass the peak discharge from the ten-year design storm.

Urban development increases the peak discharge rate associated with a given design storm, because impervious surfaces generate greater runoff volumes and drainage systems deliver it more rapidly to a stream. The change in post-development peak discharge rates that accompany development is profiled in Figure 2.6. Note that this change in hydrology increases not only the magnitude of the peak event, but the total volume of runoff produced.

Figure 2.7 Floodplain Expansion with New Development

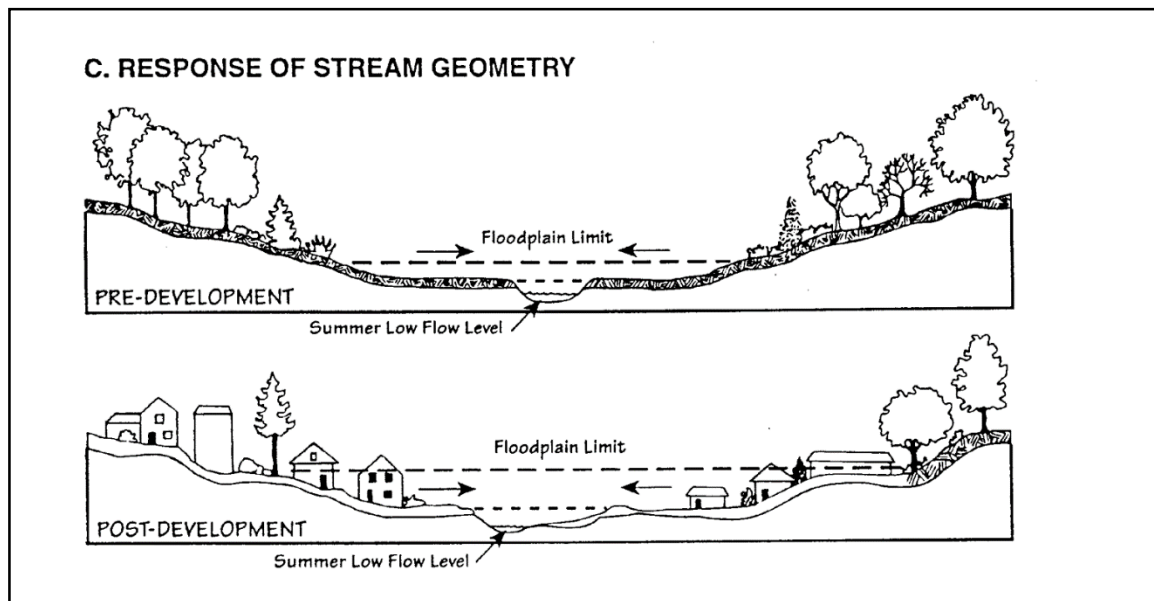

Section 2.5 Floodplain Expansion

In general, floodplains are relatively low areas adjacent to rivers, lakes, and oceans that are periodically inundated. For the purposes of this document, the floodplain is defined as the land area that is subject to inundation from a flood that has a one percent chance of-being equaled or exceeded in any given year. This is typically thought of as the 100-year flood. In New York, a 100-year flood typically occurs after between five and eight inches of rainfall in a 24-hour period (i.e., the 100-year storm). However, snow melt combined with precipitation can also lead to a 100-year flood. These floods can be very destructive, and can pose a threat to property and human life.

As with overbank floods, development sharply increases the peak discharge rate associated with the 100-year design storm. As a consequence, the elevation of a stream’s 100-year floodplain becomes higher and the boundaries of its floodplain expand (see Figure 2.7). In some instances, property and structures that had not previously been subject to flooding are now at risk. Additionally, such a shift in a floodplain’s hydrology can degrade wetland and forest habitats.

Section 2.6 Impacts to Aquatic Organisms

The decline in the physical habitat of the stream, coupled with lower base flows and higher stormwater pollutant loads, has a severe impact on the aquatic community. Research suggests that

New York State Stormwater Management Design Manual

Chapter 2: Impacts of New Development

Section 2.6 Impacts to Aquatic Organisms

new development impacts aquatic insects, fish, and amphibians at fairly low levels of imperviousness, usually around 10% impervious cover (Table 2.4). New development appears to cause declining **richness** (the number of different species in an area or community), **diversity** (number and relative frequency of different species in an area or community), and **abundance** (number of individuals in a species).

Table 2.4 Recent Research Examining the Relationship of Urbanization to Aquatic Habitat and Organisms

Watershed Indicator	Key Finding	Reference	Year	Location
Aquatic insects and fish	A comparison of three stream types found urban streams had lowest diversity and richness. Urban streams had substantially lower EPT scores (22% vs 5% as number of all taxa, 65% vs 10% as percent abundance) and IBI scores in the poor range.	Crawford & Lenat	1989	North Carolina
Insects, fish, habitat, water quality	Steepest decline of biological functioning after 6% imperviousness. There was a steady decline, with approx 50% of initial biotic integrity at 45% I.	Horner <i>et al.</i>	1996	Puget Sound Washington
Fish, aquatic insects	A study of five urban streams found that as land use shifted from rural to urban, fish and macroinvertebrate diversity decreased.	Masterson & Bannerman	1994	Wisconsin
Insects, fish, habitat, water quality, riparian zone	Physical and biological stream indicators declined most rapidly during the initial phase of the urbanization process as the percentage of total impervious area exceeded the 5-10% range.	May et al.	1997	Washington
Aquatic insects and fish	There was significant decline in the diversity of aquatic insects and fish at 10% impervious cover.	MWCOG	1992	Washington, DC

New York State Stormwater Management Design Manual

Chapter 2: Impacts of New Development

Section 2.6 Impacts to Aquatic Organisms

Table 2.4 Recent Research Examining the Relationship of Urbanization to Aquatic Habitat and Organisms

Watershed Indicator	Key Finding	Reference	Year	Location
Aquatic insects and fish	Evaluation of the effects of runoff in urban and non-urban areas found that native fish and insect species dominated the non-urban portion of the watershed, but native fish accounted for only 7% of the number of species found in urban areas.	Pitt	1995	California
Wetland plants, amphibians	Mean annual water fluctuation inversely correlated to plant & amphibian density in urban wetlands. Declines noted beyond 10% impervious area.	Taylor	1993	Seattle
Aquatic insects & fish	Residential urban land use in Cuyahoga watersheds created a significant drop in IBI scores at around 8%, primarily due to certain stressors that functioned to lower the non-attainment threshold. When watersheds smaller than 100mi ² were analyzed separately, the level of urban land use for a significant drop in IBI scores occurred at around 15%.	Yoder et. al.	1999	Ohio
Aquatic insects & fish	All 40 urban sites sampled had fair to very poor index of biotic integrity (IBI) scores, compared to undeveloped reference sites.	Yoder	1991	Ohio

IBI: Index of Biotic Integrity: A measure of species diversity for fish and macroinvertebrates

EPT: A measure of the richness of three sensitive macro-invertebrates (may flies, caddis flies, and stone flies), used to indicate the ability of a waterbody to support sensitive organisms.

Chapter 3: Stormwater Management Planning

This chapter presents a required planning process that must be followed when addressing stormwater management in new development and redevelopment projects. This process is intended to guide the designer through steps that maintain pre-construction (Note: For new development, the pre-construction terminology indicates pre-development or natural conditions) hydrologic conditions of the site by application of environmentally-sound development principles, such as Green Infrastructure, as well as treatment and control of runoff discharges from the site.

Section 3.1 Introduction

The increased emphasis on a holistic approach to resource protection, water quality treatment, flow volume control, maintenance cost reduction, and the dynamics of stormwater science has led to several changes in stormwater management. Carrying out stormwater management design standards for the past few years has provided the regulatory agencies, regulated entities, and design community with valuable experiences and a body of knowledge to enhance and improve urban runoff planning, methodologies, and techniques towards implementation of green infrastructure.

In the context of stormwater management, the term green infrastructure includes a wide array of practices at multiple scales to manage and treat stormwater, maintain and restore natural hydrology and ecological function by infiltration, evapotranspiration, capture and reuse of stormwater, and establishment of natural vegetative features. On a regional scale, green infrastructure is the preservation and restoration of natural landscape features, such as forests, floodplains and wetlands, coupled with policies such as infill and redevelopment that reduce overall imperviousness in a watershed or ecoregion. On the local scale green infrastructure consists of site- and neighborhood-specific practices and runoff reduction techniques. Such practices essentially result in runoff reduction and or establishment of habitat areas with significant utilization of soils, vegetation, and engineered media rather than traditional hardscape collection, conveyance and storage structures. Some examples include green roofs, trees and tree boxes, pervious pavement, rain gardens, vegetated swales, planters, reforestation, and protection and enhancement of riparian buffers and floodplains.

Planners and designers must address this approach in a five-step process that involves site planning and stormwater management practice (SMP) selection. The five steps include:

New York State Stormwater Management Design Manual

Chapter 3: Stormwater Management Planning

Section 3.2 Green Infrastructure for Stormwater Management

1. site planning to preserve natural features and reduce impervious cover,
2. calculation of the water quality volume for the site,
3. incorporation of runoff reduction techniques and standard SMPs with Runoff Reduction Volume (RRv) capacity,
4. use of standard SMPs, where applicable, to treat the portion of water quality volume not addressed by runoff reduction techniques and standard SMPs with RRv capacity, and
5. design of volume and peak rate control practices where required. The flow chart in Figure 3.1 summarizes the five step approach.

For detailed information on the State Pollutant Discharge Elimination System (“SPDES”) General Permit for Stormwater Discharges from Construction Activity as well as environmental permits under the Uniform Procedures Act (UPA) consult DEC web site at <http://www.dec.ny.gov/chemical/8468.html> .

Section 3.2 Green Infrastructure for Stormwater Management

The green infrastructure approach for stormwater management reduces a site’s impact on the aquatic ecosystem through the use of site planning techniques, runoff reduction techniques, and certain standard SMPs. The objective is to replicate pre-development hydrology by maintaining pre-construction infiltration, peak runoff flow, discharge volume, as well as minimizing concentrated flow by using runoff control techniques to provide treatment in a distributed manner before runoff reaches the collection system. This approach offers a distinct advantage over conventional “hard” stormwater infrastructure by reducing the production of runoff and the need for collection, storage, and treatment. When implemented throughout a development and watershed, green infrastructure can (Coffman, 2002 and USEPA, 2007):

- Reduce runoff volume, peak flow, and flow duration
- Slow down the flow to increase time of concentration and promote infiltration and evapotranspiration
- Improve groundwater recharge
- Protect downstream water resources, including wetlands

New York State Stormwater Management Design Manual

Chapter 3: Stormwater Management Planning

Section 3.2 Green Infrastructure for Stormwater Management

- Reduce downstream flooding and property damage
- Reduce incidence of combined sewer overflow (CSOs)
- Provide water quality improvements/reduced treatment costs
- Reduce thermal pollution
- Improve wildlife habitat

For the greatest level of success at reducing the negative effects of stormwater, this approach must be incorporated into an iterative site planning and design process. In the iterative site planning and design process, the designer tries various combinations of runoff reduction techniques (described in this section) and certain standard SMPs with RRv capacity (described in sections 3.3 and 3.6) to address stormwater runoff so that the RRv requirement is met. The design and layout of stormwater management features are conducted in unison with site planning and green infrastructure objectives. This approach has three primary components that mitigate the effects of stormwater runoff from development:

1. *Avoiding the Impacts – Avoid or minimize disturbance by preserving natural features and using conservation design techniques*
2. *Reducing the Impacts – Reducing the impacts of development by reducing impervious cover*
3. *Managing the Impacts – Manage the impacts by using natural features and runoff reduction practices to slow down the runoff, promote infiltration and evapo-transpiration, and consequently minimizing the need for the structural “end-of-pipe” practices*

Runoff reduction techniques are highly effective when used to address stormwater runoff from smaller, more frequent storms. As precipitation size and intensity increase, pervious surfaces become less capable of infiltrating runoff and their peak flow reduction “benefits” diminish. Thus, runoff reduction is not generally applied to larger storms. Volume and peak rate control practices for meeting quantity control objectives must be documented in the Stormwater Pollution Prevention Plan (SWPPP).

New York State Stormwater Management Design Manual

Chapter 3: Stormwater Management Planning

Section 3.2 Green Infrastructure for Stormwater Management

A summary of the green infrastructure planning tools and runoff reduction techniques covered in this Manual can be found in Tables 3.1 and 3.2. The green infrastructure planning tools, presented in Table 3.1, are practices that indirectly result in runoff reduction. A water quality reduction is realized when calculating the percentage of impervious area in the water quality volume formula in Chapter 4. The runoff reduction techniques, presented in Table 3.2, are practices for which runoff reduction is quantified. Complete definition, design specification, and computation method are presented in Chapter 5 of this manual.

Exceptions to Meeting the Runoff Reduction Volume (RRv) Criteria:

- Although encouraged, meeting the RRv criteria is not required for redevelopment activities that meet the criteria in Chapter 9 of this manual.
- Meeting the RRv criteria is required for projects over karst geology. However, the use of large infiltration basins must be avoided. A geotechnical assessment is recommended for infiltration and recharge at small scales.
- For projects that meet the “hotspot” criteria in Chapter 4 of this manual, designers shall use non-infiltration type practices to meet the RRv criteria.

Table 3.1 Green Infrastructure Planning General Categories and Specific Practices

Group	Practice	Description
Preservation of Natural Resources	Preservation of Undisturbed Areas	Delineate and place into permanent conservation easement undisturbed forests, native vegetated areas, riparian corridors, wetlands, and natural terrain.
	Preservation of Buffers	Define, delineate and place in permanent conservation easement naturally vegetated buffers along perennial streams, rivers, shorelines and wetlands.
	Reduction of Clearing and Grading	Limit clearing and grading to the minimum amount needed for roads, driveways, foundations, utilities and stormwater management facilities.

New York State Stormwater Management Design Manual

Chapter 3: Stormwater Management Planning

Section 3.2 Green Infrastructure for Stormwater Management

	Locating Development in Less Sensitive Areas	Avoid sensitive resource areas such as floodplains, steep slopes, erodible soils, wetlands, mature forests and critical habitats by locating development to fit the terrain in areas that will create the least impact.
	Open Space Design	Use clustering, conservation design or open space design to reduce impervious cover, preserve more open space and protect water resources.
	Soil Restoration	Restore the original properties and porosity of the soil by deep till and amendment with compost to reduce the generation of runoff and enhance the runoff reduction performance of practices such as grass channels, filter strips, and tree clusters.
Reduction of Impervious Cover	Roadway Reduction	Minimize roadway widths and lengths to reduce site impervious area
	Sidewalk Reduction	Minimize sidewalk lengths and widths to reduce site impervious area
	Driveway Reduction	Minimize driveway lengths and widths to reduce site impervious area
	Cul-de-sac Reduction	Minimize the number of cul-de-sacs and incorporate landscaped areas to reduce their impervious cover.
	Building Footprint Reduction	Reduce the impervious footprint of residences and commercial buildings by using alternate or taller buildings while maintaining the same floor to area ratio.
	Parking Reduction	Reduce imperviousness on parking lots by eliminating unneeded spaces, providing compact car spaces and efficient parking lanes, minimizing stall dimensions, using porous pavement surfaces in overflow parking areas, and using multi-storied parking decks where appropriate.

New York State Stormwater Management Design Manual

Chapter 3: Stormwater Management Planning

Section 3.2 Green Infrastructure for Stormwater Management

Table 3.2 Acceptable Runoff Reduction Techniques

Group	Practice	Description
Runoff Reduction Techniques	Conservation of natural areas	Retain the pre-development hydrologic and water quality characteristics of undisturbed natural areas, stream and wetland buffers by restoring and/or permanently conserving these areas on a site.
	Sheetflow to riparian buffers or filter strips	Undisturbed natural areas such as forested conservation areas and stream buffers or vegetated filter strips and riparian buffers can be used to treat and control stormwater runoff from some areas of a development project.
	Vegetated open swale	The natural drainage paths, or properly designed vegetated channels, can be used instead of constructing underground storm sewers or concrete open channels to increase time of concentration, reduce the peak discharge, and provide infiltration.
	Tree planting / tree box	Plant or conserve trees to reduce stormwater runoff, increase nutrient uptake, and provide bank stabilization. Trees can be used for applications such as landscaping, stormwater management practice areas, conservation areas and erosion and sediment control.
	Stream daylighting for redevelopment projects	Stream Daylight previously-culverted/piped streams to restore natural habitats, better attenuate runoff by increasing the storage size, promoting infiltration, and help reduce pollutant loads.
	Rain garden	Manage and treat small volumes of stormwater runoff using a conditioned planting soil bed and planting materials to filter runoff stored within a shallow depression.
	Green roof	Capture runoff by a layer of vegetation and soil installed on top of a conventional flat or sloped roof. The rooftop vegetation allows evaporation and evapotranspiration processes to reduce volume and discharge rate of runoff entering conveyance system.
	Stormwater planter	Small landscaped stormwater treatment devices that can be designed as infiltration or filtering practices. Stormwater planters use soil infiltration and biogeochemical processes to decrease stormwater quantity and improve water quality.
	Rain tank/Cistern	Capture and store stormwater runoff to be used for irrigation systems or filtered and reused for non-contact activities.
	Porous Pavement	Pervious types of pavements that provide an alternative to conventional paved surfaces, designed to infiltrate rainfall through the surface, thereby reducing stormwater runoff from a site and providing some pollutant uptake in the underlying soils.

New York State Stormwater Management Design Manual

Chapter 3: Stormwater Management Planning

Section 3.3 Standard Stormwater Management Practices for Treatment

Section 3.3 Standard Stormwater Management Practices for Treatment

This section presents a list of standard stormwater management practices (SMPs) that are acceptable for water quality treatment. The practices on this list were selected based on the following criteria:

1. Can capture and treat the full water quality volume (WQv)
2. Are capable of 80% TSS removal and 40% TP removal.
3. Have acceptable longevity in the field.
4. Have a pretreatment mechanism.

It also provides data justifying the use of these practices, and minimum criteria for the addition of new practices to the list.

Standard SMPs are structural practices that are acceptable for water quality treatment and meet the performance standards defined in Chapter 6 of this manual. These practices are designed to capture and treat the water quality volume (the portion infeasible to retain onsite using runoff reduction techniques) through one or more pollutant removal pathway(s) and their performances are documented by removal efficiency of specific pollutants. The standard SMPs are often sited as “end-of-the-pipe” treatment systems and designed to function as storage or flow-through systems.

3.3.1 Practice List

Practices on the following list will be presumed to meet water quality requirements set forth in this manual if designed in accordance with the sizing criteria presented in Chapter 4 and constructed in accordance with the performance criteria in Chapter 6. The practices must also be maintained properly in accordance with the prescribed maintenance criteria also presented in Chapter 6. Acceptable practices are divided into five broad groups, including:

- I. **Stormwater Ponds** Practices that have either a permanent pool of water or a combination of permanent pool and extended detention capable of treating the WQv

New York State Stormwater Management Design Manual

Chapter 3: Stormwater Management Planning

Section 3.3 Standard Stormwater Management Practices for Treatment

- II. **Stormwater Wetlands** Practices that include significant shallow marsh areas, and may also incorporate small permanent pools and extended detention storage to achieve the full WQ_v

- III. **Infiltration Practices** Practices that capture and temporarily store the WQ_v before allowing it to infiltrate into the soil.

- IV. **Filtering Practices** Practices that capture and temporarily store the WQ_v and pass it through a filter bed of sand, organic matter, soil, or other acceptable treatment media.

- V. **Open Channel Practices** Practices explicitly designed to capture and treat the full WQ_v within dry or wet cells formed by check dams or other means.

Within each of these broad categories, select practices are presumed to meet the established water quality goals (see Table 3.3). Guidance on the performance criteria for each practice type and matrices for selecting practices are provided in Chapters 6 and 7.

New York State Stormwater Management Design Manual

Chapter 3: Stormwater Management Planning

Section 3.3 Standard Stormwater Management Practices for Treatment

Table 3.3 Stormwater Management Practices Acceptable for Water Quality

Group	Practice	Description
Pond	Micropool Extended Detention Pond (P-1)	Pond that treats the majority of the water quality volume through extended detention, and incorporates a micropool at the outlet of the pond to prevent sediment resuspension.
	Wet Pond (P-2)	Pond that provides storage for the entire water quality volume in the permanent pool.
	Wet Extended Detention Pond (P-3)	Pond that treats a portion of the water quality volume by detaining storm flows above a permanent pool for a specified minimum detention time.
	Multiple Pond System (P-4)	A group of ponds that collectively treat the water quality volume.
	Pocket Pond (P-5)	A stormwater wetland design adapted for the treatment of runoff from small drainage areas that has little or no baseflow available to maintain water elevations and relies on ground water to maintain a permanent pool.
Wetland	Shallow Wetland (W-1)	A wetland that provides water quality treatment entirely in a wet shallow marsh.
	Extended Detention Wetland (W-2)	A wetland system that provides some fraction of the water quality volume by detaining storm flows above the marsh surface.
	Pond/ Wetland System (W-3)	A wetland system that provides a portion of the water quality volume in the permanent pool of a wet pond that precedes the marsh for a specified minimum detention time.
	Pocket Wetland (W-4)	A shallow wetland design adapted for the treatment of runoff from small drainage areas that has variable water levels and relies on groundwater for its permanent pool.
Infiltration	Infiltration Trench (I-1)	An infiltration practice that stores the water quality volume in the void spaces of a gravel trench before it is infiltrated into the ground.
	Infiltration Basin (I-2)	An infiltration practice that stores the water quality volume in a shallow depression, before it is infiltrated it into the ground.
	Dry Well (I-3)	An infiltration practice similar in design to the infiltration trench, and best suited for treatment of rooftop runoff.
Filtering Practices	Surface Sand Filter (F-1)	A filtering practice that treats stormwater by settling out larger particles in a sediment chamber, and then filtering stormwater through a sand matrix.
	Underground Sand Filter (F-2)	A filtering practice that treats stormwater as it flows through underground settling and filtering chambers.
	Perimeter Sand Filter (F-3)	A filter that incorporates a sediment chamber and filter bed as parallel vaults adjacent to a parking lot.
	Organic Filter (F-4)	A filtering practice that uses an organic medium such as compost in the filter, in the place of sand.
	Bioretention (F-5)	A shallow depression that treats stormwater as it flows through a soil matrix, and is returned to the storm drain system.
Open Channels	Dry Swale (O-1)	An open drainage channel or depression explicitly designed to detain and promote the filtration of stormwater runoff into the soil media.
	Wet Swale (O-2)	An open drainage channel or depression designed to retain water or intercept groundwater for water quality treatment.

New York State Stormwater Management Design Manual

Chapter 3: Stormwater Management Planning

Section 3.4 Quantity Controls

3.3.2 *Criteria for Practice Addition*

The stormwater field is always evolving, and new technologies constantly emerge. The New York State Department of Environmental Conservation supports the development of innovative practices, provided the green infrastructure requirements are met, and allows the use of manufactured systems where specific site conditions demand. However, the Department currently does not have a stormwater management practice verification process in place. Instead, the Department relies on the verification and certification process, being implemented by other regulatory agencies with technical standards similar to those of New York State, to identify the alternative practices that are acceptable for installation in New York State.

The goals for performance of practices remain consistent with the performance criteria as stated in Section 3.3 of this Manual. A list of acceptable sources of verification for new stormwater management practices is provided on the Department's website. All proposed alternative stormwater management practices in new construction are considered to be in deviation from State Standards. Such practices must provide a full description to justify the reason(s) for deviation as well as detailed justification on how the proposed practice is equivalent to the standards defined in this Design Manual. In order to be in compliance with the technical standards, projects must meet both required performance and sizing criteria. All proposed alternative practices must at minimum meet the sizing criteria as defined in Chapter 4 of this Design Manual. The equivalency of the performance of the proposed new technologies to the performance criteria required by the State of New York must be verified and certified by one of the sources accepted by the Department and documented in the SWPPP. All design and plan review professionals must adhere to the design parameters that constitute the removal efficiency equivalent to the Department's performance criteria (80% TSS removal and 40% phosphorus removal).

Specific requirements for redevelopment applications are addressed in Chapter 9 of this Design Manual.

Section 3.4 Quantity Controls

Quantity control practices are systems which are primarily designed for channel protection, safe conveyance of the flow, and flood control. Most quantity control facilities are structural systems that provide detention and control discharge rate. Some examples of quantity control practices include detention ponds, underground storage vaults (chambers, large diameter pipe), and blue roofs. Infiltration practices can also be used as an accepted control for up to the 10-year storm, provided the infiltration rate is greater than 5.0 in/hr. In addition, extended detention storage may be provided above the water quality volume in

New York State Stormwater Management Design Manual

Chapter 3: Stormwater Management Planning

Section 3.5 Maintenance Requirements

an infiltration basin with a proper outlet design. This allows a designer to meet all the quantity control sizing criteria in Chapter 4 (Cpv, Qp, Qf).

Flood controls are primarily managed through detention structures. Examples of quantity control facilities are presented in Table 3.4.

Table 3.4 Stormwater Management Practices for Stormwater Quantity Control

Group	Practice	Description
Above ground systems	Dry Detention	Dry detention basins and dry extended detention basins are surface facilities intended to provide for the temporary storage of stormwater runoff to reduce downstream water quantity impacts.
	Blue Roofs	Blue roofs (rooftop detention systems) are constructed by installing slotted flow restriction devices known as collars or restrictors around the roof drains of flat, structurally sound, waterproof roofs. By this mechanism, stormwater is detained on the roof and the peak rate of discharge is reduced.
Underground systems	Underground Storage Vaults (chambers, pipes)	An underground storage system is a subsurface stormwater system suitable for sites within high-density urban areas. Such systems are designed as an arched structure, a vault or large diameter pipe and function in both permeable and non-permeable soils for subsurface detention of stormwater runoff or infiltration. Chambers, vaults or pipes can decrease the peak flow when used with a controlled flow orifice at the outlet.
Infiltration Systems	Infiltration Basin	Practices that capture and temporarily store runoff before allowing it to either infiltrate into the soil (Infiltration rate > 5 in/hr) or be released by a controlled outlet. (*See EPA Class V injection well language in Chapter 4)

This Design Manual does not provide design specifications for the quantity control practices. However, example technical drawings and examples of outlet structure sizing (orifices and weir), and determination of detention time are presented in Chapters 4 and 8 of this Design manual.

Section 3.5 Maintenance Requirements

The responsibility for implementation of long term operation and maintenance of a post-construction stormwater management practice shall be vested with a responsible party by means of a legally binding and enforceable mechanism such as a maintenance agreement, deed covenant or other legal measure. This

New York State Stormwater Management Design Manual

Chapter 3: Stormwater Management Planning

Section 3.5 Maintenance Requirements

mechanism shall protect the practice from neglect, adverse alteration and/or unauthorized removal. The mechanism and Operation and Maintenance (O&M) plan must be included in the SWPPP.

At a minimum, the O&M plan must address each of the following:

1. An owner of a post-construction stormwater management practice, including the runoff reduction practices and SMPs included in this Design Manual, shall erect or post, in the immediate vicinity of the stormwater management practice, a conspicuous and legible sign of not less than 18 inches by 24 inches (or 10"X12" for footprints smaller than 400 sf) bearing the following information:
2. **Stormwater Management Practice** - (*name of the practice*)
3. Project Identification - (SPDES Construction Permit #, other)
4. Must Be Maintained In Accordance With O&M Plan
5. **DO NOT REMOVE OR ALTER**
6. Example:
7. **Stormwater Management Practice** – Rain Garden
8. Project Identification - SPDES NYR10K123
9. Must Be Maintained In Accordance With O&M Plan
10. **DO NOT REMOVE OR ALTER**
11. Identification of the entity that will be responsible for long term operation and maintenance of the stormwater management practices.
12. Identification of the mechanism(s) that will be used to ensure long term operation and maintenance of the stormwater management practices (Deed covenant, easements/rights-of-way, executed maintenance agreement, etc.). Include a copy of such mechanism.
13. A copy of the schematics of the practice, with the measurements of design specifications clearly defined.
14. A list of maintenance requirements (already defined in this Design Manual and the additional site specific requirements), proper frequency, and a maintenance log for tracking and observation.

New York State Stormwater Management Design Manual

Chapter 3: Stormwater Management Planning

Section 3.6 The Six Step Process for Stormwater Site Planning and Practice Selection

Section 3.6 The Six Step Process for Stormwater Site Planning and Practice Selection

Stormwater management using green infrastructure is summarized in the five step process described below (See Figure 3.1 also). Designers are required to adhere to the five step process when developing a SWPPP. This includes providing information in the SWPPP which documents compliance with the required process.

Step 1: Site Planning

In Step 1, the designer uses practices identified in Table 3.1 to protect natural resources and utilize the hydrology of the site before laying out the proposed development. The Preservation of Natural Resources practices (see Table 3.1) include protecting natural areas, avoiding sensitive areas and minimizing grading and soil disturbance. The designer then considers practices to reduce impervious cover when laying out the initial site design. The Reduction of Impervious Cover practices (see Table 3.1) include conservation design and reducing impervious cover in roads, driveways and parking lots.

The SWPPP must include an evaluation of all the green infrastructure planning measures as they apply to the site. This evaluation process requires the following measures:

- Developing a map that identifies natural resource areas and drainage patterns; including but not limited to:
 - Wetlands (jurisdictional, wetland of special concern)
 - Waterways (major, perennial, intermittent, springs)
 - Buffers (stream, wetland, forest, etc.)
 - Floodplains
 - Forest, vegetative cover
 - Critical areas
 - Topography (contour lines, existing flow paths, steep slopes, etc.)
 - Soil (hydrologic soil groups, highly erodible soils, etc.)
 - Bedrock, significant geology features
- Devising the strategies for protection and enhancement of natural resources

New York State Stormwater Management Design Manual

Chapter 3: Stormwater Management Planning

Section 3.6 The Six Step Process for Stormwater Site Planning and Practice Selection

- Prior to site layout, preserve natural features (site fingerprinting)
 - Utilize natural features to preserve the natural hydrology
 - Maintain natural drainage design points
 - Maximize retention of forest cover and undisturbed soils
 - Avoid erodible soils on steep slopes and limit mass grading
- Reducing the impacts of development by reducing impervious surfaces
 - Demonstrating that all reasonable opportunities for preserving natural conditions of the site are employed to minimize the runoff and maintain the pre-construction hydrology

During the planning step, the designer should check with the municipality to determine if there are local laws and ordinances that regulate wetlands, stream buffers, forest or habitat protection, erosion control or grading. If present, the local regulations will determine minimum areas of protection that the designer can then expand upon to maximize runoff reduction objectives. The designer should also consult the municipality for laws relating to conservation or cluster design, roads, driveways and parking lots to determine the level of flexibility in reducing impervious surfaces.

This component of the plan must also be clearly addressed in the Erosion and Sediment Control (ESC) Plan (Development of ESC plan is provided in the New York Standards and Specifications for Erosion and Sediment Control). Description and minimum requirements for meeting site planning principles are presented in Chapter 5 of this Manual.

Step 2: Determine Water Quality Treatment Volume (WQv)

In Step 2, the designer calculates the required WQv for the site using the criteria in Chapter 4. Once the preliminary site layout is prepared, impervious areas are defined, and sub-catchments are delineated, the designer should calculate the water quality volume. This initial calculation of WQv may have to be revised after runoff reduction techniques are applied.

Step 3: Apply Runoff Reduction Techniques and Standard SMPs with RRv Capacity (e.g. infiltration practices, bioretention and open channel practices) to Reduce Total WQv

New York State Stormwater Management Design Manual

Chapter 3: Stormwater Management Planning

Section 3.6 The Six Step Process for Stormwater Site Planning and Practice Selection

In Step 3, the designer experiments with combinations of runoff reduction techniques and standard SMPs with RRv capacity on the site. In each case, the designer estimates the spatial area to be treated by each runoff reduction technique, potentially reducing the required WQv by incorporating runoff reduction techniques or standard SMPs with RRv capacity within each drainage area on the site.

Runoff Reduction techniques are grouped into two categories:

- Practices resulting in a reduction of contributing area
 - Examples: preservation/restoration of conservation areas, vegetated channel, etc.
- Practices resulting in a reduction of contributing volume
 - Example: green roofs, stormwater planters, and rain gardens

The standard SMPs with RRv capacity are listed in Table 3.5. A designer can apply the following percentages of WQv (provided by the standard SMP) towards meeting the RRv sizing criteria, provided the design of the practice complies with the “Required Elements” in Chapter 6:

Table 3.5 Runoff Reduction Capacity for Standard SMPs	
SMP	RRv Capacity (% of WQv provided by practice)
Infiltration Practices (by source control)	100%
Bioretention Practice	100% in HSG A and B (without underdrain)
	40% HSG C and D (with underdrain)
Dry Swale (Open Channel Practice)	40% in HSG A and B
	20% in HSG C and D

If the standard SMPs with RRv capacity listed above are going to be used to address the RRv criteria, the practices must be designed to capture runoff near the source. The practices must be localized systems that are installed throughout the site at each runoff source, thereby minimizing the use of traditional “end-of-pipe” treatment systems.

By applying a combination of runoff reduction techniques and standard SMPs with RRv capacity, the designer must reduce 100% of the WQv calculated in Step 2. If the RRv calculated in this step is greater than or equal to the WQv calculated in Step 2, the designer has met the RRv requirement and may proceed

New York State Stormwater Management Design Manual

Chapter 3: Stormwater Management Planning

Section 3.6 The Six Step Process for Stormwater Site Planning and Practice Selection

to Step 6. Unless it can be demonstrated that site limitations exist to provide relief from reducing 100% of the WQv, designers must return to Step 1 to see if an alternative site plan or combination of the runoff reduction techniques and standard SMPs with RRv capacity can be applied to achieve compliance with the RRv sizing criteria. Acceptable site limitations include conditions that prevent the use of an infiltration technique and or infiltration of the total WQv. Typical site limitations include: seasonal high groundwater, shallow depth to bedrock, and soils with an infiltration rate less than 0.5 inches/hour. For construction activities that cannot reduce the total WQv, the designer shall identify the specific site limitations in the SWPPP

In the event that a designer cannot reduce 100% of the WQv due to site limitations, they shall direct runoff from all newly constructed impervious areas to a RR technique or standard SMP with RRv capacity unless infeasible. For each area where runoff from newly constructed impervious area is not directed towards a RR technique or standard SMP with RRv capacity, the designer must provide justification in the SWPPP as to why each of the aforementioned practices are infeasible. If a demonstration of infeasibility cannot be made, then the designer must return to Step 1 to see if an alternative site plan or combination of the runoff reduction techniques and standard SMPs with RRv capacity can be applied to achieve compliance with the RRv sizing criteria. .

Note: The design specifications and runoff reduction credit for the runoff reduction techniques and standards SMPs with RRv capacity are provided in Chapters 5 and 6 of this Manual, respectively.

Step 4: Determine the minimum RRv required

In Step 4, the designer determines the minimum RRv required for the construction activity as calculated using the criteria in Section 4.3 of this Design Manual and compares this to the runoff reduction achieved from impervious surfaces (determined in Step 3). In no case shall the runoff reduction achieved from the newly constructed impervious areas be less than the Minimum RRv.

Step 5: Apply Standard Stormwater Management Practices to Address Remaining Water Quality Volume

In Step 5, the designer uses standard SMPs (see Table 3.3) such as filtering practices, ponds, or stormwater wetlands to treat the remaining water quality volume that cannot be reduced by applying the runoff reduction techniques and standard SMPs with RRv capacity. The designer must verify that the RRv

New York State Stormwater Management Design Manual

Chapter 3: Stormwater Management Planning

Section 3.6 The Six Step Process for Stormwater Site Planning and Practice Selection

requirement has been met; otherwise the plan does not comply with the required sizing criteria in Chapter 4.

Step 6: Apply Volume and Peak Rate Control Practices if Still Needed to Meet Requirements

The channel protection volume, overbank flood control, and extreme flood control must be met for the plan to be completed. In Step 6, the designer may use practices such as infiltration basins, dry detention basins, and blue roofs to meet water quantity requirements.

New York State Stormwater Management Design Manual

Chapter 3: Stormwater Management Planning

Section 3.6 The Six Step Process for Stormwater Site Planning and Practice Selection

Figure 3.1: Stormwater Site Planning and Practice Selection Flow Chart

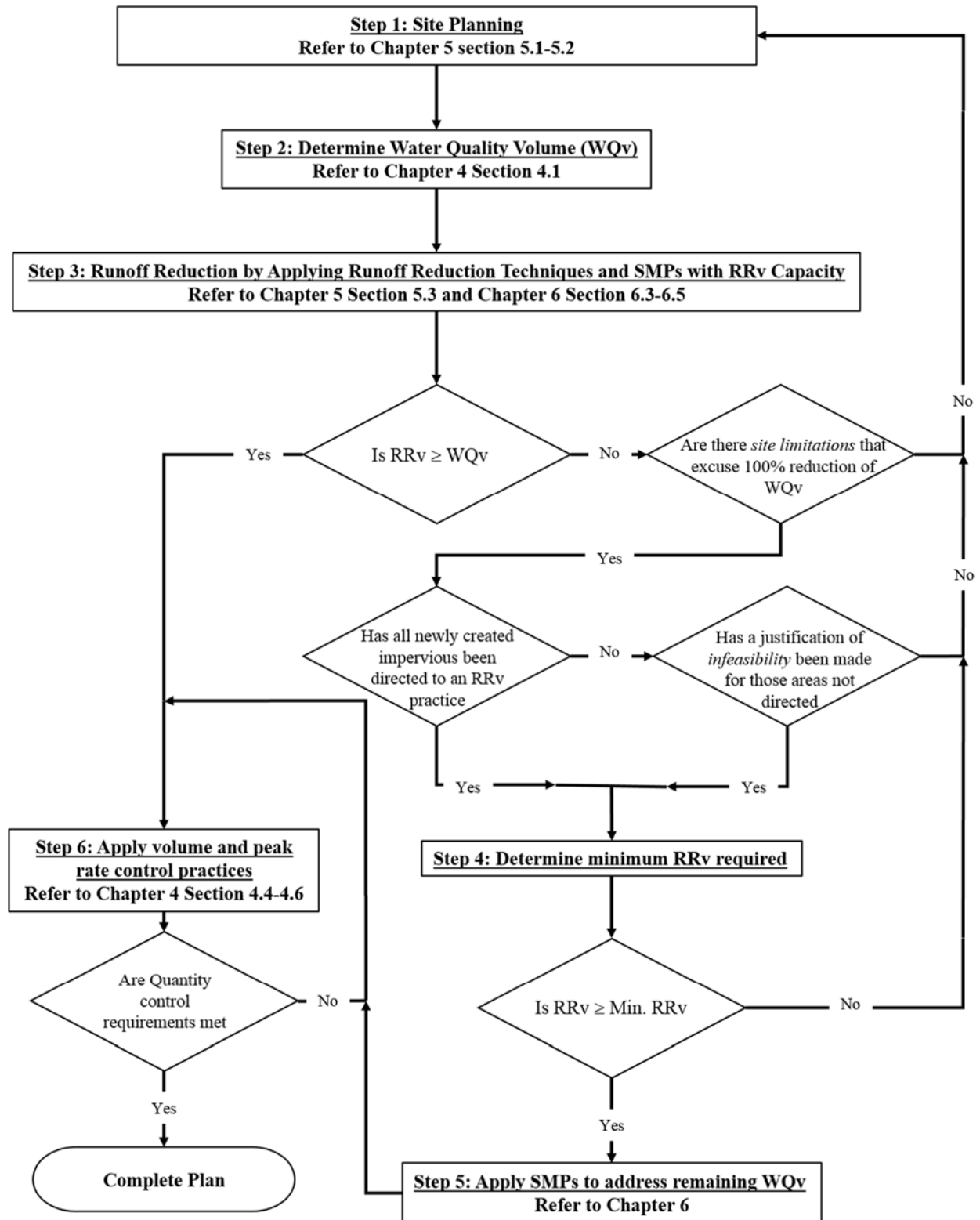

Chapter 4: Unified Stormwater Sizing Criteria

Table 4.1 New York Stormwater Sizing Criteria¹

<p>Water Quality Volume (WQV) Water Quality</p>	<p>90% Rule: $WQv(\text{acre-feet}) = [(P)(Rv)(A)] / 12$ $Rv = 0.05 + 0.009(I)$ I = Impervious Cover (Percent) P(inch) = 90% Rainfall Event Number (See Figure 4.1)² A = site area in acres</p>
<p>Runoff Reduction Volume(RRv)</p>	<p>RRv (acre-feet) = Reduction of the total WQv by application of runoff reduction techniques and standard SMPs with RRv capacity to replicate pre-development hydrology. The minimum required RRv is defined as the Specified Reduction Factor (S), provided objective technical justification is documented.</p>
<p>Channel Protection Volume(Cpv)</p>	<p>Default Criterion: $Cpv(\text{acre-feet}) = 24 \text{ hour extended detention of post-developed 1-year, 24-hour storm event; remaining after runoff reduction. Where site conditions allow, Runoff reduction of total CPv, is encouraged for Sites Larger than 50 Acres:}$ Distributed Runoff Control - geomorphic assessment to determine the bankfull channel characteristics and thresholds for channel stability and bedload movement.</p>
<p>Overbank Flood (Qp)</p>	<p>$Qp(\text{cfs}) = \text{Control the peak discharge from the 10-year storm to 10-year predevelopment rates.}$</p>
<p>Extreme Storm (Qf)h</p>	<p>$Qf(\text{cfs}) = \text{Control the peak discharge from the 100-year storm to 100-year predevelopment rates. Safely pass the 100-year storm event.}$</p>
<p>Alternative method (WQv):</p>	<p>Design, construct, and maintain systems sized to capture, reduce, reuse, treat, and manage rainfall on-site, and prevent the off-site discharge of the precipitation from all rainfall events less than or equal to the 95th percentile rainfall event, computed by an acceptable continuous simulation model.</p>

¹ Channel protection, overbank flood, and extreme storm requirements may be waived in some instances if the conditions specified in this chapter are met. For SMPs involving dams, follow Appendix A, Guidelines for Design of Dams for safe passage of the design flood.

² For required sizing criteria in redevelopment projects and phosphorus limited watersheds refer to Chapters 9 and 10, respectively.

New York State Stormwater Management Design Manual

Chapter 4: Unified Stormwater Sizing Criteria

Section 4.1 Introduction

Section 4.1 Introduction

This chapter presents a unified approach for sizing green infrastructure for runoff reduction and SMPs to meet pollutant removal goals, reduce channel erosion, prevent overbank flooding, and help control extreme floods. For a summary, please consult Table 4.1 below. The remaining sections describe the sizing criteria in detail and present guidance on how to properly compute and apply the required reduction and storage volumes.

Section 4.2 Water Quality Volume (WQ_v)

The Water Quality Volume (denoted as the WQ_v) is intended to improve water quality by capturing and treating runoff from small, frequent storm events that tend to contain higher pollutant levels. New York has defined the WQ_v as the volume of runoff generated from the entire 90th percentile rain event. Essentially what this means is that a practice sized using the WQ_v will capture and treat 90% of all 24 hour rain events. The WQ_v is directly related to the amount of impervious cover constructed at a site. Contour lines of the 90% rainfall event are presented in Figure 4.1.

The following equation can be used to determine the water quality storage volume WQ_v (in acre-feet of storage):

$$WQ_v = \frac{P * R_v * A}{12}$$

where:

WQ_v = water quality volume (in acre-feet)

P = 90% Rainfall Event Number (see Figure 4.1)

R_v = 0.05 + 0.009(I), where I is percent impervious cover

A = site area in acres (Contributing area)

New York State Stormwater Management Design Manual

Chapter 4: Unified Stormwater Sizing Criteria

Section 4.2 Water Quality Volume (WQv)

Figure 4.1: 90th Percentile Rainfall in New York State (NYSDEC, 2013)

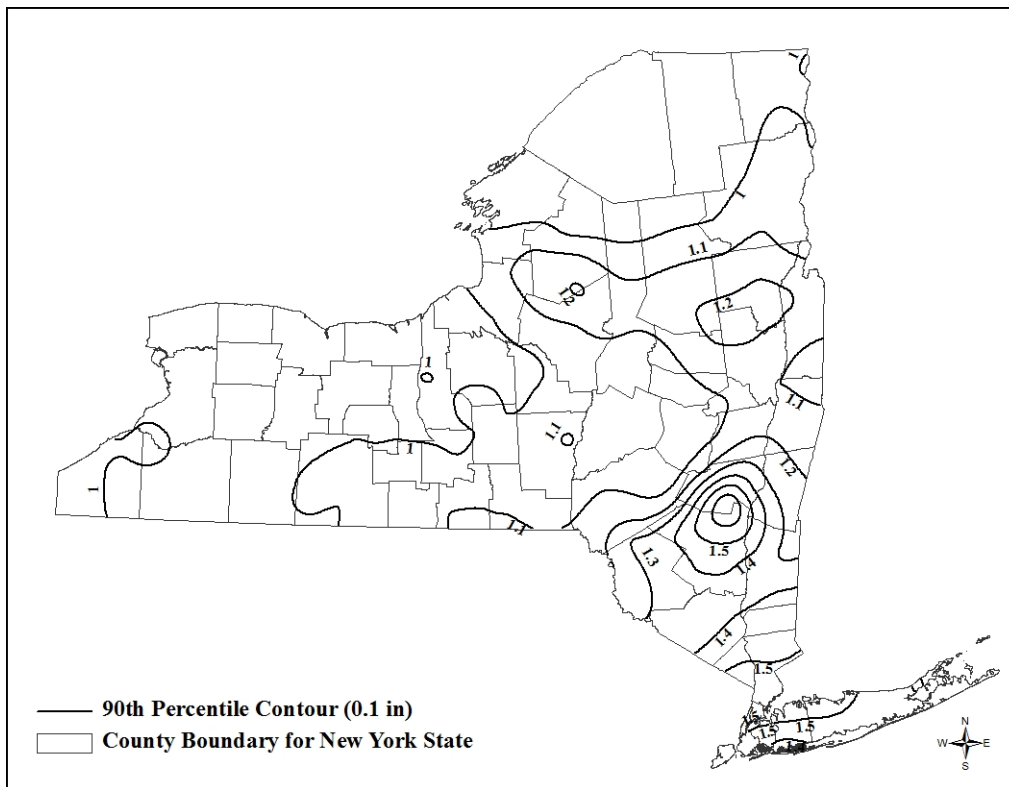

Basis of Design for Water Quality

As a basis for design, the following assumptions may be made:

Measuring Impervious Cover: the measured area of a site plan that does not have permanent vegetative or permeable cover shall be considered total impervious cover. Impervious cover is defined as all impermeable surfaces and includes: paved and gravel road surfaces, paved and gravel parking lots, paved driveways, building structures, paved sidewalks, and miscellaneous impermeable structures such as patios, pools, and sheds. Where site size makes direct measurement of impervious cover impractical, the land use/impervious cover relationships presented in Table 4.2 can be used to initially estimate impervious cover. In site specific planning impervious cover must be calculated based the specific proposed impervious cover.

New York State Stormwater Management Design Manual

Chapter 4: Unified Stormwater Sizing Criteria

Section 4.2 Water Quality Volume (WQv)

Table 4.2 Land Use and Impervious Cover(Source: Capiella and Brown, 2001)	
Land Use Category	Mean Impervious Cover
Agriculture	2
Open Urban Land*	9
2 Acre Lot Residential	11
1 Acre Lot Residential	14
1/2 Acre Lot Residential	21
1/4Acre Lot Residential	28
1/8 Acre Lot Residential	33
Townhome Residential	41
Multifamily Residential	44
Institutional**	28-41%
Light Industrial	48-59%
Commercial	68-76%
* Open urban land includes developed park land, recreation areas, golf courses, and cemeteries.	
** Institutional is defined as places of worship, schools, hospitals, government offices, and police and fire stations	

- *Aquatic Resources:* More stringent local regulations may be in place or may be required to protect drinking water reservoirs, lakes, or other sensitive aquatic resources. Consult the local authority to determine the full requirements for these resources.

New York State Stormwater Management Design Manual

Chapter 4: Unified Stormwater Sizing Criteria

Section 4.3 Runoff Reduction Volume (RRv)

- *SMP Treatment:* The final WQ_v , remaining after application of runoff reduction sizing criterion, shall be treated by an acceptable practice from the list presented in this manual. Please consult Chapter 3 for a list of acceptable practices.
- *Determining Peak Discharge for WQ_v Storm:* When designing flow splitters for off-line practices, consult the small storm hydrology method provided in Appendix B.
- *Extended Detention for Water Quality Volume:* The water quality requirement for storage systems can be met by providing 24 hours of the WQ_v (provided a micropool is specified) extended detention. A local jurisdiction may reduce this requirement to as little as 12 hours in trout waters to prevent stream warming. If TR-55 method is used for the design of stormwater management practices for storms greater than 90%, detention time may be calculated using either a center of mass method or plug flow calculation method.
- *Off-site Areas:* Where off-site areas will drain to the SMP, calculate imperviousness of the off-site contributing drainage area based on its current condition. If water quality treatment is provided off-line, the practice must only treat on-site runoff.

Section 4.3 Runoff Reduction Volume (RRv)

Runoff Reduction Volume (RRv)	RRv (acre-feet)=Reduction of the total WQ_v by application of green infrastructure techniques and SMPs to replicate pre-development hydrology. The minimum required RRv is defined as the Specified Reduction Factor (S), provided objective technical justification is documented.
----------------------------------	--

- Runoff reduction shall be achieved by infiltration, groundwater recharge, reuse, recycle, evaporation/evapotranspiration of 100 percent of the post-development water quality volume to replicate pre-development hydrology by maintaining pre-construction infiltration, peak runoff flow, discharge volume, as well as minimizing concentrated flow by using runoff control techniques to provide treatment in a distributed manner before runoff reaches the collection system. This requirement can be accomplished by application of on-site green infrastructure techniques, standard stormwater management practices with runoff reduction capacity, and good operation and maintenance.

New York State Stormwater Management Design Manual

Chapter 4: Unified Stormwater Sizing Criteria

Section 4.3 Runoff Reduction Volume (RRv)

- Runoff reduction volume (RRv) may be calculated based on three methods:
 1. Reduction of the practice contributing area in WQv computation (as defined in Chapter 5)
 2. Reduction of runoff volume by storage capacity of the practice (as defined in Chapter 5)
 3. Reduction using standards SMPs with runoff reduction capacity (as defined in Chapter 3)
- Projects that cannot meet 100% of runoff reduction requirement due to site limitations that prevent the use of an infiltration technique and/or infiltration of the total WQv shall identify the specific site limitations in the SWPPP. Typical site limitations include: seasonal high groundwater, shallow depth to bedrock, and soils with an infiltration rate less than 0.5 inches/hr.
- Construction activities that cannot achieve 100% reduction of the total WQv due to site limitations shall direct runoff from all newly constructed impervious areas to a RR technique or standard SMP with RRv capacity unless infeasible. In no case shall the runoff reduction achieved from the newly constructed impervious areas be less than the minimum runoff reduction volume (RRv_{min}) determined by the following equation:

$$RRv_{min} = \frac{P * \bar{R}_v * Aic * S}{12}$$

Where:

RRv_{min} = Minimum runoff reduction volume required from impervious area (acre-feet)

$\bar{R}_v = 0.05 + 0.009(I)$ where I is 100% impervious

Aic = Total area of new impervious cover

S = Hydrologic Soil Group (HSG) Specific Reduction Factor (S)

The specific reduction factor (S) is based on the HSGs present at a site. The following lists the specific reduction factors for the HSGs:

- HSG A = 0.55
- HSG B = 0.40

New York State Stormwater Management Design Manual

Chapter 4: Unified Stormwater Sizing Criteria

Section 4.4 Stream Channel Protection Volume Requirements (C_{pv})

- HSG C = 0.30
 - HSG D = 0.20
- The basic premise of runoff reduction is to formally recognize the water quality benefits of certain site design practices to address flow as a pollutant of concern. Reduction of water quality treatment volume is a requirement and reduction of water “quantity” volumes associated with channel protection (C_{pv}) is encouraged, where soil conditions allow. While runoff reduction methods can be highly effective in reducing WQ_v , small benefits are offered for peak discharge control of overbank flood control (Q_p) and extreme flood control (Q_f). If a developer incorporates one or more runoff reduction practices in the design of the site, the required SMP volume for capture and water quality treatment will be reduced.
- Site designers and developers are allowed to utilize as many runoff reduction methods as they can on a site. Greater reductions in stormwater storage volumes can be achieved when many techniques are combined (e.g., disconnecting rooftops and protecting natural conservation areas). However, reduction cannot be claimed twice for an identical area of the site (e.g., claiming the stream buffers and disconnecting rooftops over the same site area).
- An Underground Injection Control Permit may be required when certain conditions are met. Designer must Consult EPA’s fact sheet for further information:
 - http://www.epa.gov/safewater/uic/class5/types_stormwater.html
 - http://www.epa.gov/ogwdw000/uic/class5/pdf/fs_uic-class5_classvstudy_fs_storm.pdf
- Designers must be selective with the design of infiltration on sites with karst geology, shallow bedrock and soils, and hotspot land uses. Projects located over karst geology must provide runoff reduction by techniques that do not involve large infiltration basins and deep, concentrated recharge to the ground. A geotechnical assessment is recommended for infiltration and recharge at small scales. For projects identified as “hotspot” runoff reduction cannot be provided by infiltration, unless an enhanced treatment that addresses the pollutants of concern is provided.

New York State Stormwater Management Design Manual

Chapter 4: Unified Stormwater Sizing Criteria

Section 4.4 Stream Channel Protection Volume Requirements (C_{pv})

- Stream Channel Protection Volume Requirements (C_{pv}) are designed to protect stream channels from erosion. In New York State this goal is accomplished by providing 24-hour extended detention of the one-year, 24-hour storm event, remained from runoff reduction.
- Reduction of runoff for meeting stream channel protection objectives, where site conditions allow, is encouraged and the volume reduction achieved through green infrastructure can be deducted from C_{pv} . Trout waters may be exempted from the 24-hour ED requirement, with only 12 hours of extended detention required to meet this criterion. Detention time may be calculated using either a center of mass method or plug flow calculation method.

For developments greater than 50 acres, with impervious cover greater than 25%, it is recommended that a detailed geomorphic assessment be performed to determine the appropriate level of control. Appendix J provides guidance on how to conduct this assessment.

The C_{pv} requirement does not apply in certain conditions, including the following:

- Reduction of the entire C_{pv} volume is achieved at a site through green infrastructure or infiltration systems.
- The site discharges directly tidal waters or fifth order (fifth downstream) or larger streams. Within New York State, streams are classified using the following:

New York State Codes Rules and Regulations (NYCRR)
Volumes B-F, Parts 800-941
West Publishing, Eagan, MN

However this classification system does not provide a numeric stream order. The methodology identified in this Manual is consistent with Strahler-Horton methodology. For an example of stream order identification see section 4.9.

Detention ponds or underground detention systems and vaults are methods to meet the C_{pv} requirement (and subsequent Q_{p10} and Q_f criteria). Note that, although these practices meet water quantity goals, they are unacceptable for water quality because of poor pollutant removal, and need to be coupled with a practice listed in Tables 3.2 and 3.3. The C_{pv} requirement may also be provided above the water quality (WQ_v) storage in a wet pond or stormwater wetland.

Basis for Determining Channel Protection Storage Volume

New York State Stormwater Management Design Manual

Chapter 4: Unified Stormwater Sizing Criteria

Section 4.4 Stream Channel Protection Volume Requirements (C_pv)

The following represent the minimum basis for design:

- TR-55 and TR-20 (or approved equivalent) shall be used to determine peak discharge rates.
- Rainfall depths for the one-year, 24 hour storm event are provided in Figure 4.2.
- Off-site areas should be modeled as "present condition" for the one-year, 24 hour storm event.
- The length of overland flow used in time of concentration (t_c) calculations is limited to no more than 100 feet for post development conditions.
- The C_pv control orifice should be designed to reduce the potential to clog with debris. An individual orifice may not be required for C_pv at sites where the resulting diameter of the ED orifice is too small, to prevent clogging. Alternatively a minimum 3" orifice with a trash rack or 1" if the orifice is protected by a standpipe, having slots with an area less than the internal orifice are recommended. (See Figure 3 in Appendix K for design details).
- Extended detention storage provided for the channel protection (C_pv-ED) does not meet the WQ_v requirement. Both water quality and channel protection storage may be provided in the same SMP, however.
- The C_pv detention time for the one-year storm is defined as the time difference between the center of mass of the inflow hydrograph (entering the SMP) and the center of mass of the outflow hydrograph (leaving the SMP). See Appendix B for a methodology for detaining this storm event.
- The isohyets maps for required design storms are presented in this Manual. However, as precipitation data are updated, designers may use the most recent rainfall frequency values developed by acceptable sources. These map are available online at <http://precip.eas.cornell.edu>.

New York State Stormwater Management Design Manual

Chapter 4: Unified Stormwater Sizing Criteria

Section 4.5 Overbank Flood Control Criteria (Q_p)

Figure 4.2: One-Year Design Storm in New York State (NYSDEC, 2013)

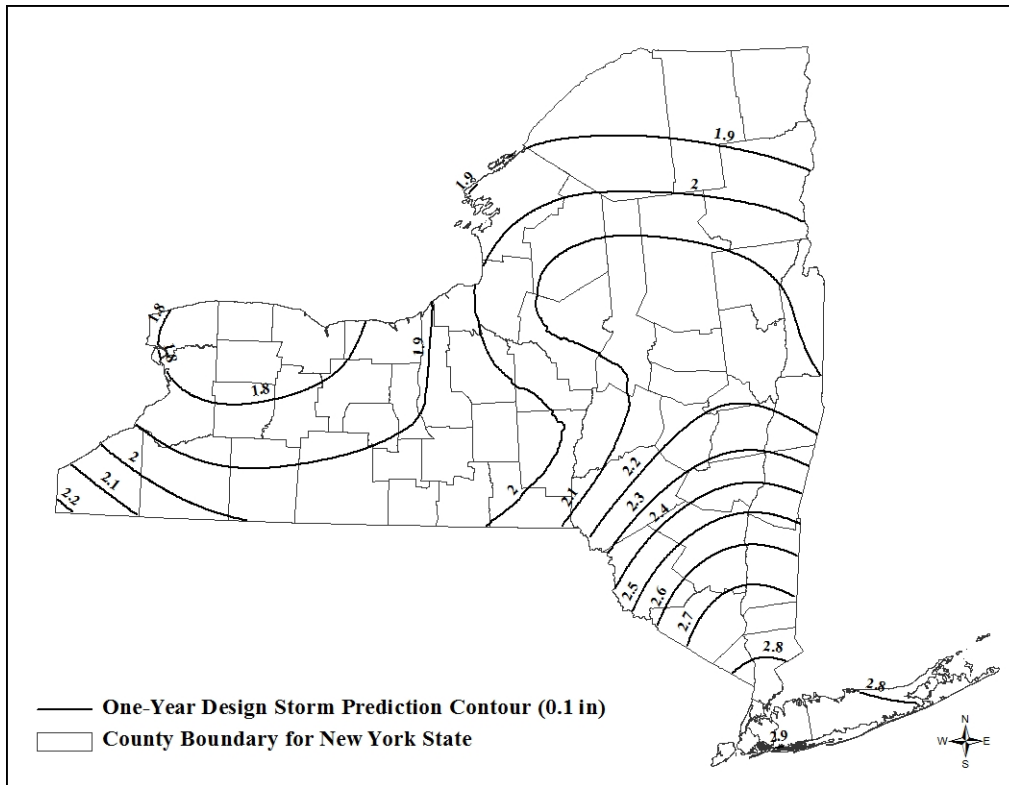

Section 4.5 Overbank Flood Control Criteria (Q_p)

The primary purpose of the overbank flood control sizing criterion is to prevent an increase in the frequency and magnitude of out-of-bank flooding generated by urban development (i.e., flow events that exceed the bankfull capacity of the channel, and therefore must spill over into the floodplain).

Overbank control requires storage to attenuate the post development 10-year, 24-hour peak discharge rate (Q_p) to predevelopment rates.

The overbank flood control requirement (Q_p) does not apply in certain conditions, including:

- The site discharges directly tidal waters or fifth order (fifth downstream) or larger streams. Refer to Section 4.3 for instructions.
- A downstream analysis reveals that overbank control is not needed (see section 4.10).

Basis for Design of Overbank Flood Control

When addressing the overbank flooding design criteria, the following represent the minimum basis for design:

New York State Stormwater Management Design Manual

Chapter 4: Unified Stormwater Sizing Criteria

Section 4.5 Overbank Flood Control Criteria (Qp)

- TR-55 and TR-20 (or approved equivalent) will be used to determine peak discharge rates.
- When the predevelopment land use is agriculture, the curve number for the pre-developed condition shall be “taken as meadow”.
- Off-site areas should be modeled as "present condition" for the 10-year storm event.
- Figure 4.3 indicates the depth of rainfall (24 hour) associated with the 10-year storm event throughout the State of New York.
- The length of overland flow used in t_c calculations is limited to no more than 150 feet for predevelopment conditions and 100 feet for post development conditions. On areas of extremely flat terrain (<1% average slope), this maximum distance is extended to 250 feet for predevelopment conditions and 150 feet for post development conditions.

Figure 4.3: Ten-Year Design Storm in New York State (NYSDEC, 2013)

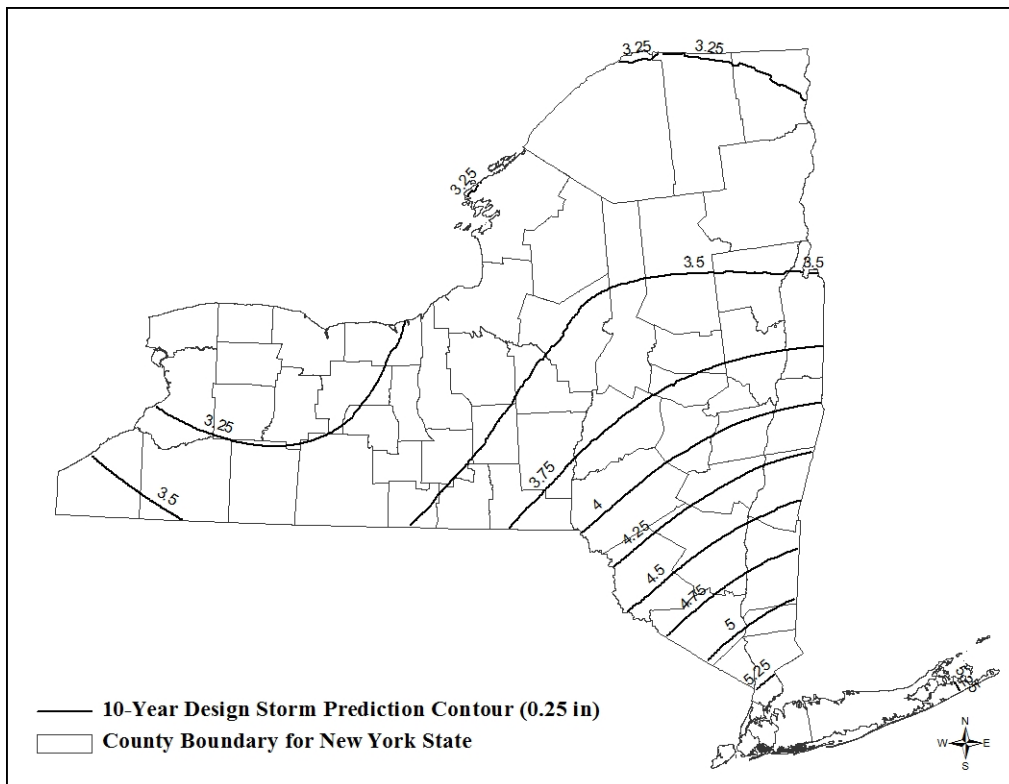

New York State Stormwater Management Design Manual

Chapter 4: Unified Stormwater Sizing Criteria

Section 4.6 Extreme Flood Control Criteria (Q_f)

Section 4.6 Extreme Flood Control Criteria (Q_f)

The intent of the extreme flood criteria is to (a) prevent the increased risk of flood damage from large storm events, (b) maintain the boundaries of the predevelopment 100-year floodplain, and (c) protect the physical integrity of stormwater management practices.

100 Year Control requires storage to attenuate the post development 100-year, 24-hour peak discharge rate (Q_f) to predevelopment rates.

The 100-year storm control requirement can be waived if:

- The site discharges directly tidal waters or fifth order (fifth downstream) or larger streams. Refer to Section 4.3 for instructions.
- Development is prohibited within the ultimate 100-year floodplain
- A downstream analysis reveals that 100-year control is not needed (see section 4.10)

Detention structures involving dams must provide safe overflow of the design flood, as discussed in Appendix A: “Guidelines for the Design of Dams.” The flow rates and floodplain extents referred to herein should not be confused with those developed by FEMA for use in the NFIP. Often FEMA has developed 10, 50, 100 and 500-yr flow rates for streams in developed, flood-prone areas, as shown in the Flood Insurance Study (FIS) for a given community. However, it should be noted that these flowrates are only provided at selected locations along studied streams, generally represent the watershed conditions existing at the time of the study, and are commonly developed using stream gauge records or USGS regression equations and therefore do not have any associated storm duration. The extents of the special flood hazard area (SFHA) as shown on the flood insurance rate maps (FIRMs) are defined using these flowrates. These flowrates and flood extents should not be used to compare the pre and post-project development conditions for the purposes of designing on storm water management facilities.

Basis for Design for Extreme Flood Criteria

- The same hydrologic and hydraulic methods used for overbank flood control shall be used to analyze Q_f.
- Figure 4.4 indicates the depth of rainfall (24 hour) associated with the 100-year storm event throughout New York State.

New York State Stormwater Management Design Manual

Chapter 4: Unified Stormwater Sizing Criteria

Section 4.7 Alternative Method

- When determining the storage required to reduce 100-year flood peaks, model off-site areas under current conditions.
- When determining storage required to safely pass the 100-year flood, model off-site areas under ultimate conditions.

Figure 4.4: One Hundred-Year Design Storm in New York State (NYSDEC, 2013)

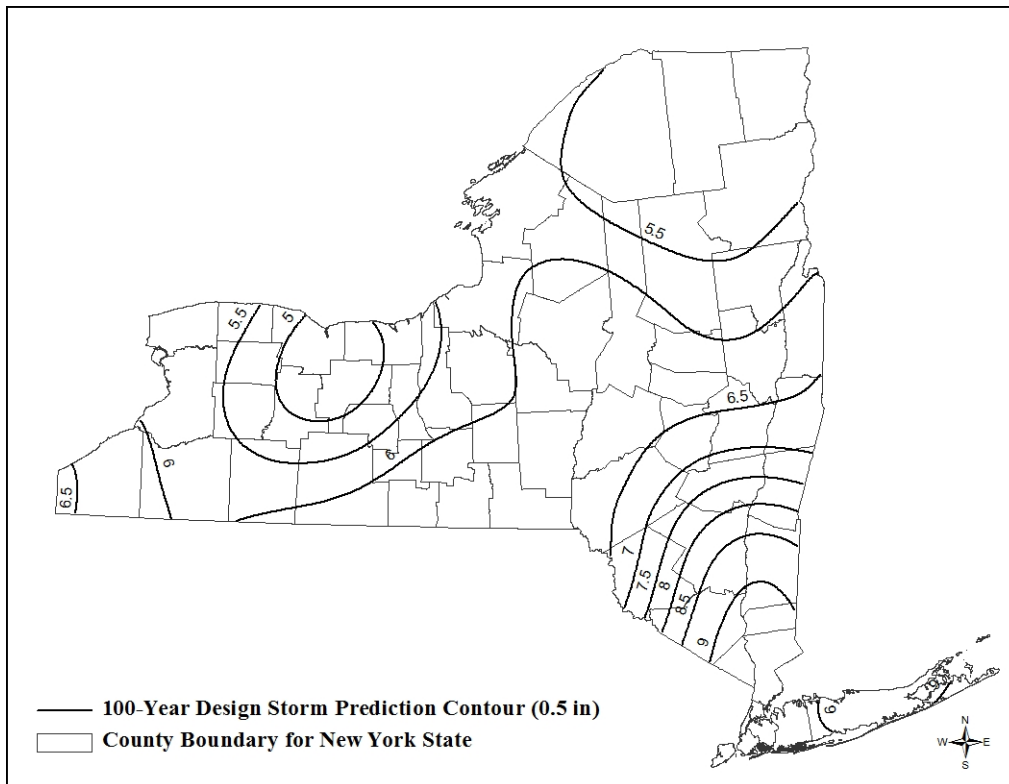

Section 4.7 Alternative Method

New development causes changes to runoff volume, flow rates, timing of runoff and, most importantly, habitat destruction and degradation of the physical and chemical quality of the receiving waterbody. Traditionally, event based design storms are used for evaluation of hydrology and sizing of stormwater management practices. With an increasing need for assessment of the long term effects of development and maintenance of pre-development hydrology, the necessity of continuous simulation modeling as an effective tool for analysis and evaluation of flow-duration, downstream quality, quantity, biological, and hydro-habitat sustainability has been acknowledged.

New York State Stormwater Management Design Manual

Chapter 4: Unified Stormwater Sizing Criteria

Section 4.7 Alternative Method

Continuous simulation models utilize historical precipitation records for estimating runoff volumes, duration, and pollutant loading. This method allows examination of watershed parameters' responses to long term of storm events, instead of the response to a site level single theoretical design storm provided by single event based models. Calculation of WQv using continuous simulation modeling accounts for infiltration, evapotranspiration, depression storage, and system storage, which allows a detailed and objective comparison of alternative treatments to determine if watershed characteristics are maintained by those treatments. Consequently, continuous simulation modeling allows for simulation of green infrastructure techniques and performance of flow duration analyses. An objective application of a continuous simulation model involves a calibrated model for a watershed on interest and incorporation of regional goals.

The following lists the guidelines for the design of stormwater management systems using a continuous simulation model:

- Design, construct, and maintain systems sized to capture, reduce, reuse, treat, and manage rainfall on-site, and prevent the off-site discharge of the precipitation from all rainfall events less than or equal to the 95th percentile rainfall event.
- The 95th percentile rainfall event is the event whose precipitation total is greater than or equal to 95 percent of all storm events over a given period of record.
- A minimum period of 20 years precipitation records is required to determine the 95th percentile storm and derive the corresponding design storm.
- Select a practice(s) that provides infiltration, evapotranspiration, reuse, or recycle of this volume.
- One hundred percent (100%) of the volume of water from storms less than or equal to the 95th percentile event shall not be discharged to surface water.
- Perform an analysis that shows post-construction flow-duration, shape of the hydrograph, and downstream quality and quantity does not exceed pre-construction hydrology.
- Site evaluation and soils analysis must conform to the standards provided in this Manual.
- The stormwater management practices employed must conform to the standards provided in this Manual.

New York State Stormwater Management Design Manual

Chapter 4: Unified Stormwater Sizing Criteria

Section 4.8 Conveyance Criteria

Some examples of continuous simulation modeling tools include:

Stormwater Management Model (SWMM) is an EPA supported urban runoff hydrology, hydraulics, and runoff quality model with detailed design tools capable of flow routing and storage for surface, sub-surface, stormwater and combined sewer overflow conveyance and groundwater systems, as well as determining the treatment capacity of stormwater management practices. Various applications of SWMM have utilized the detailed features of this model for simulating green infrastructure design features.

Source Loading and Management Model for Windows (WinSLAMM) is a mid-range empirical model for evaluation of stormwater runoff loading in urban watersheds. This modeling tool uses small storm hydrology methods and calculates the runoff from historical precipitation data for a given period of time, pollutant loading from various land uses, and allows the user to simulate the stormwater load reduction effected by incorporating control devices. The stormwater management practices provided in WinSLAMM include several SMPs, green infrastructure design details and maintenance BMPs.

Hydrologic Simulation Program Fortran (HSPF) is an EPA supported program for simulation of watershed hydrology and water quality. The HSPF model uses information such as the time history of rainfall, temperature, soil, land surface such as land cover and land-use patterns; and land management practices to simulate the processes that occur in a watershed. The result of this simulation is a time history of the quantity and quality of runoff from an urban or agricultural watershed. The model also predicts flow rate, sediment load, and nutrient concentrations.

A successful example of the use of HSPF for stormwater applications is the Western Washington Hydrologic Model (WWHM). Similar adaptation of the models for applications in New York State will require several verifications such as validation of input variables, accurate precipitation data, and calibration of the model.

Section 4.8 Conveyance Criteria

In addition to the stormwater treatment volumes described above, this manual also provides guidance on safe and non-erosive conveyance to, from, and through SMPs. Typically, the targeted storm frequencies for conveyance are the two-year and ten-year events. The two-year event is used to ensure non-erosive flows through roadside swales, overflow channels, pond pilot channels, and over berms within practices. Figure 4.5 presents rainfall depths for the two-year, 24-hour storm event throughout New York State. The 10-year storm is typically used as a target sizing for outfalls, and as a safe conveyance criterion for open channel practices and overflow channels. The 10-year storm is recommended as a minimum sizing criterion for

New York State Stormwater Management Design Manual

Chapter 4: Unified Stormwater Sizing Criteria

Section 4.9 Stream Order Identification

closed conveyance systems. Note that some agencies or municipalities may use a different design storm for this purpose.

Figure 4.5: 2-Year Design Storm (2013)

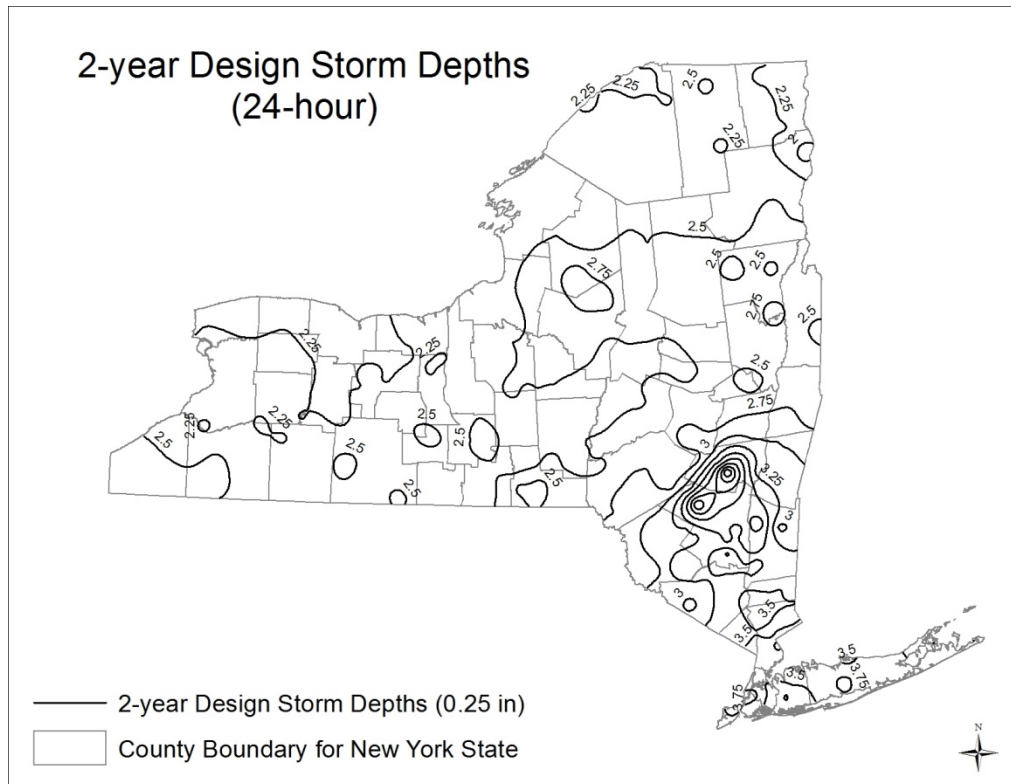

Section 4.9 Stream Order Identification

This section provides an example to help identify stream order based on Strahler-Horton Method. A network of streams drain each watershed. Streams can be classified according to their order in that network. A stream that has no tributaries or branches is defined as a first-order stream. When two first-order streams combine, a second-order stream is created, and so on. Figure 4.6 illustrates the stream order concept (Schueler, T. 1995).

Evaluation of stream order must be performed using the NHDplus dataset to determine if quantity controls do not apply. NHDplus is an integrated suite of geospatial data sets that incorporate features of the National Hydrography Dataset (NHD) and the National Elevation Dataset (NED) at 1:100K scale. This application-ready data set is an outcome of a multi-agency effort aimed at developing many useful variables for water quality and quantity evaluation including stream order. Example maps are available on DEC website.

New York State Stormwater Management Design Manual

Chapter 4: Unified Stormwater Sizing Criteria

Section 4.10 Downstream Analysis

Figure 4.6 A Network of Headwater and Third-order Streams (Source: Schueler, 1995)

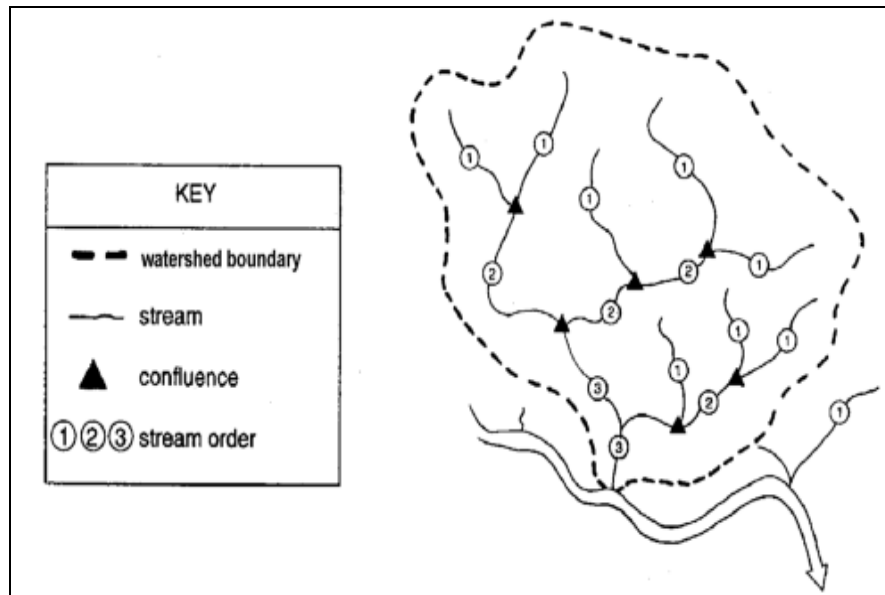

Section 4.10 Downstream Analysis

Overbank, and extreme flood requirements may be waived based on the results of a downstream analysis. In addition, such an analysis for overbank and extreme flood control is recommended for larger sites (i.e., greater than 50 acres) to size facilities in the context of a larger watershed. The analysis will help ensure that storage provided at a site is appropriate when combined with upstream and downstream flows. For example, detention at a site may in some instances exacerbate flooding problems within a watershed. This section provides brief guidance for conducting this analysis, including the specific points along the downstream channel to be evaluated and minimum elements to be included in the analysis.

Downstream analysis can be conducted using the 10% rule. That is, the analysis should extend from the point of discharge downstream to the point on the stream where the site represents 10% of the total drainage area. For example, the analysis points for a 10-acre area would include points on the stream from the points of discharge to the nearest downstream point with a drainage area of 100 acres. The required elements of the downstream analysis are described below.

- Compute pre-development and post-development peak flows and velocities for design storms (e.g., 10-year and 100-year), at all downstream confluences with first order or higher streams up to and including the point where the 10% rule is met. These analyses should include scenarios both with and without stormwater treatment practices in place, where applicable.

New York State Stormwater Management Design Manual

Chapter 4: Unified Stormwater Sizing Criteria

Section 4. 11 Stormwater Hotspots

- Evaluate hydrologic and hydraulic effects of all culverts and/or obstructions within the downstream channel.
- Assess water surface elevations to determine if an increase in water surface elevations will impact existing buildings and other structures.

The design, or exemption, at a site level can be approved if both of the following criteria are met:

- Peak flow rates increase by less than 5% of the pre-developed condition for the design storm (e.g., 10-year or 100-year)
- No downstream structures or buildings are impacted.

Section 4. 11 Stormwater Hotspots

A stormwater hotspot is defined as a land use or activity that generates higher concentrations of hydrocarbons, trace metals or toxicants than are found in typical stormwater runoff, based on monitoring studies. If a site is designated as a hotspot, it has important implications for how stormwater is managed. First and foremost, stormwater runoff from hotspots cannot be allowed to infiltrate untreated into groundwater, where it may contaminate water supplies. Second, a greater level of stormwater treatment for hydrocarbons, trace metals or toxicants of concern is needed at hotspot sites to prevent pollutant washoff after construction. This treatment typically involves preparing and *implementing a stormwater pollution prevention plan* that includes a series of operational practices at the site that reduce the generation of pollutants from a site or prevent contact of rainfall with the pollutants. Table 4.3 provides a list of designated hotspots for the State of New York.

Under EPA's stormwater NPDES program, some industrial sites are required to prepare and implement a stormwater pollution prevention plan. A list of industrial categories that are subject to the pollution prevention requirement can be found in the State of New York SPDES General Permit for Stormwater Discharges Associated with Industrial Activity. In addition, New York's requirements for preparing and implementing a stormwater pollution prevention plan are described in the SPDES general discharge permit. The stormwater pollution prevention plan requirement applies to both existing and new industrial sites.

New York State Stormwater Management Design Manual

Chapter 4: Unified Stormwater Sizing Criteria

Section 4.11 Stormwater Hotspots

Table 4.3 Classification of Stormwater Hotspots

The following land uses and activities are deemed *stormwater hotspots*:

Vehicle salvage yards and recycling facilities #

Vehicle fueling stations

Vehicle service and maintenance facilities

Vehicle and equipment cleaning facilities #

Fleet storage areas (bus, truck, etc.) #

Industrial sites (based on SIC codes outlined in the SPDES General Permit for Stormwater Discharges Associated with Industrial Activity)

Marinas (service and maintenance) #

Outdoor liquid container storage

Outdoor loading/unloading facilities

Public works storage areas

Facilities that generate or store hazardous materials #

Commercial container nursery

Other land uses and activities as designated by an appropriate review authority

indicates that the land use or activity is required to prepare a stormwater pollution prevention plan under the SPDES stormwater program.

The following land uses and activities are not normally considered hotspots:

- Residential streets and rural highways
- Residential development
- Institutional development
- Office developments
- Non-industrial rooftops
- Pervious areas, except golf courses and nurseries (which may need an Integrated Pest Management (IPM) Plan)

While large highways (average daily traffic volume (ADT) greater than 30,000) are not designated as a stormwater hotspot, it is important to ensure that highway stormwater management plans adequately protect groundwater.

Chapter 5: Green Infrastructure Practices

This Chapter presents planning and design of green infrastructure practices acceptable for runoff reduction. Green infrastructure planning includes measures for preservation of natural features of the site and reduction of proposed impervious cover. The green infrastructure techniques include practices that enable reductions in the calculated runoff from contributing areas and the required water quality volume.

Section 5.1 Planning for Green Infrastructure: Preservation of Natural Features and Conservation Design

The first step in planning for stormwater management using green infrastructure is to avoid or minimize land disturbance by preserving natural areas. Development should be strategically located based on the location of resource areas and physical conditions at a site. Also, in finalizing construction, soils must be restored to the original properties and according to the intended function of the proposed practices. Preservation of natural features includes techniques to foster the identification and preservation of natural areas that can be used in the protection of water, habitat and vegetative resources. Conservation design includes laying out the elements of a development project in such a way that the site design takes advantage of a site’s natural features, preserves the more sensitive areas and identifies any site constraints and opportunities to prevent or reduce negative effects of development. The techniques covered in this section are listed in Table 5.1.

Table 5.1 Planning Practices for Preservation of Natural Features and Conservation	
Practice	Description
Preservation of Undisturbed Areas	Delineate and place into permanent conservation undisturbed forests, native vegetated areas, riparian corridors, wetlands, and natural terrain.
Preservation of Buffers	Define, delineate and preserve naturally vegetated buffers along perennial streams, rivers, shorelines and wetlands.
Reduction of Clearing and Grading	Limit clearing and grading to the minimum amount needed for roads, driveways, foundations, utilities and stormwater management facilities.
Locating Development in Less Sensitive Areas	Avoid sensitive resource areas such as floodplains, steep slopes, erodible soils, wetlands, mature forests and critical habitats by locating development to fit the terrain in areas that will create the least impact.
Open Space Design	Use clustering, conservation design or open space design to reduce impervious cover, preserve more open space and protect water resources.
Soil Restoration	Restore the original properties and porosity of the soil by deep till and amendment with compost to reduce the generation of runoff and enhance the runoff reduction performance of post construction practices.

5.1.1 Preservation of Undisturbed Areas

Description: Important natural features and areas such as undisturbed forested and native vegetated areas, natural terrain, riparian corridors, wetlands and other important site features should be delineated and placed into permanent conservation areas.

Key Benefits

- Helps to preserve a site’s natural hydrology and water balance
- Can act as a non-structural stormwater feature to promote additional filtration and infiltration
- Can help to preserve a site’s natural character, habitat and aesthetic appeal
- Has been shown to increase property values for adjacent parcels
- Can reduce structural stormwater management storage requirement and may be used in runoff reduction calculations (see section 5.3)

Figure 5.1 Example of natural resource inventory plan (Source: Georgia Stormwater Manual, 2001)

Typical Perceived Obstacles and Realities

- Preserved conservation areas may limit the development potential of a site – With clustering and other development incentives, development yield can be maintained
- Preserved conservation areas may harbor nuisance wildlife, vegetation, and insects and may present safety hazards - Once established, natural conservation areas must be protected during construction and managed after occupancy by a responsible party able to maintain the areas in a natural state in perpetuity; proper

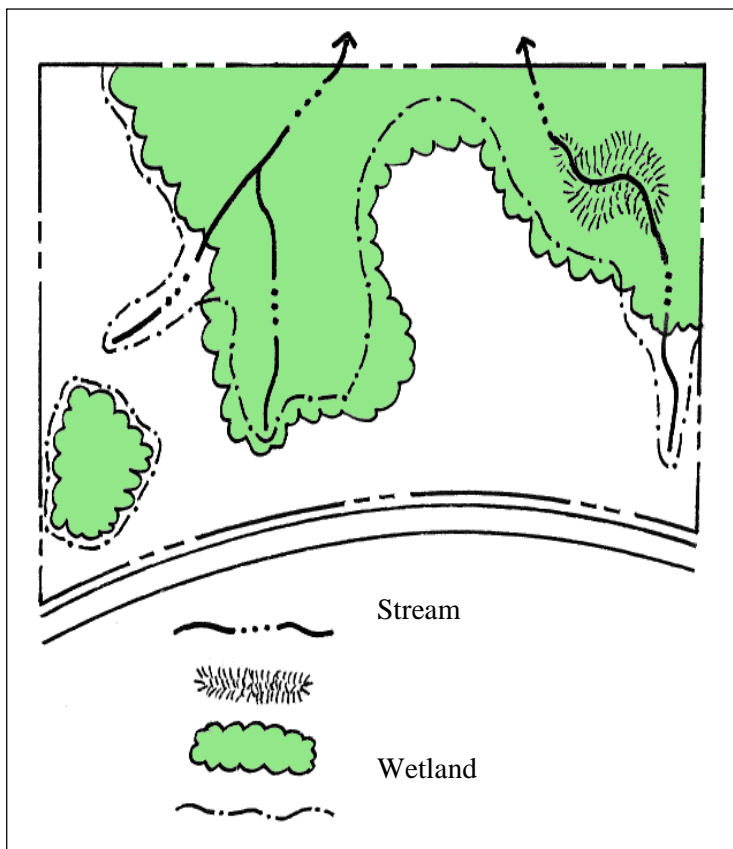

New York State Stormwater Management Design Manual

Chapter 5: Green Infrastructure Practices

Section 5.1 Planning for Green Infrastructure: Preservation of Natural Features and Conservation Design

management and maintenance will address nuisance and safety issues

Using this Practice

- Delineate and define natural conservation areas before performing site layout and design
- Ensure that conservation areas and native vegetation are protected in an undisturbed state through the design, construction and occupancy stages
- Check with the municipality to determine if there are local laws and ordinances that regulate wetlands, stream buffers, forests or habitat protection

Discussion

Conservation of natural areas such as undisturbed forested and native-vegetated areas, natural terrain, riparian corridors and wetlands on a development project can help to preserve pre-development hydrology of the site and aid in reducing stormwater runoff and pollutant load. Previously disturbed and/or managed forest areas may be considered for permanent conservation if they are judged to provide the benefits outlined in this section. Undisturbed vegetated areas also promote soil stabilization and provide for filtering and infiltration of runoff.

Figure 5.2 Aerial photograph of development project illustrating preservation of undisturbed natural areas (Source: Arendt, 1996)



Natural conservation areas are typically identified through a site-analysis stage using mapping and field-reconnaissance assessments. Areas proposed for protection should be delineated early in the planning stage, long before any site design, clearing or construction begins. When done before the concept-plan phase, the planned conservation areas can be used to guide the layout of a project. Figure 5.1 shows components of a natural resources inventory map with proposed conservation areas delineated.

Preservation areas should then be incorporated into site-development plans and clearly marked on all construction and grading plans to ensure that construction activities are kept out of these areas and that native

New York State Stormwater Management Design Manual

Chapter 5: Green Infrastructure Practices

Section 5.1 Planning for Green Infrastructure: Preservation of Natural Features and Conservation Design

vegetation is undisturbed. The boundaries of each conservation area should be mapped by carefully determining the limit which should not be crossed by construction activity.

Once established, natural conservation areas must be protected during construction and managed after occupancy by a responsible party able to maintain the areas in a natural state in perpetuity. Typically, conservation areas are protected by legally enforceable deed restrictions, conservation easements or a maintenance agreement. When one or more of these measures is applied, a permanently protected natural area can be used to reduce the area required for treatment by structural stormwater management measures (see Figure 5.2 for a representative project illustrating natural resource area protection).

5.1.2 Preservation of Buffers

Description: Naturally vegetated buffers should be defined, delineated and preserved along perennial streams, rivers, shorelines and wetlands.

Key Benefits

- Riparian buffers treat stormwater and improve water quality
- Can be used as nonstructural stormwater infiltration zones
- Can keep structures out of the floodplain and provide a right-of-way for large flood events
- Help to preserve riparian ecosystems and habitats
- Can serve as recreational areas
- May be used in runoff reduction calculations if the criteria in this section are met

Typical Perceived Obstacles and Realities

- Buffers may result in a potential loss of developable land – Regulatory tools or other incentives may be available to protect the interests of property owners
- Private landowners may be required to provide public access to privately held stream buffers – Effective buffers can be maintained in private ownership through deed restrictions and conservation easements
- Nuisance wildlife, vegetation, and insects will be present due to the natural buffer area – Once established, vegetated buffers must be protected during construction and managed after occupancy

New York State Stormwater Management Design Manual

Chapter 5: Green Infrastructure Practices

Section 5.1 Planning for Green Infrastructure: Preservation of Natural Features and Conservation Design

by a responsible party able to maintain the areas in a natural state in perpetuity; proper management and maintenance will address nuisance issues

Figure 5.3 Buffer around Rondout Creek, Accord, NY



Using this Practice

- Delineate and preserve naturally vegetated riparian buffers (as well as vegetated buffers along streams listed as intermittent by the Department)
- Define the width, identify the target vegetation, and designate methods to preserve the buffer indefinitely
- Ensure that buffers and native vegetation are protected throughout planning, design, construction and occupancy
- Consult local planning authority for local wetland and/or stream regulations or guidelines for more stringent minimum buffer width

Discussion

A riparian buffer is a special type of natural conservation area along a stream, wetland or shoreline where development is restricted or prohibited. The primary function of buffers is to protect and physically separate a stream, lake, coastal shoreline or wetland from polluted stormwater discharges from future disturbance or encroachment. If properly designed, a buffer can provide stormwater management functions, can act as a right-of-way during floods, and can sustain the integrity of water-resource ecosystems and habitats. An example of a riparian stream buffer is shown in Figure 5.3.

New York State Stormwater Management Design Manual

Chapter 5: Green Infrastructure Practices

Section 5.1 Planning for Green Infrastructure: Preservation of Natural Features and Conservation Design

Forested riparian buffers should be maintained and managed and reforestation should be encouraged where no wooded buffer exists. Proper restoration should include all layers of the forest plant community, including understory, shrubs and groundcover, not just trees. A riparian buffer can be of fixed or variable width but should be continuous and not interrupted by impervious areas that would allow stormwater to concentrate and flow into the stream without first flowing through the buffer.

Ideally, riparian buffers should be sized to include the 100-year floodplain as well as steep banks and freshwater wetlands. The buffer depth needed to perform properly will depend on the size of the stream and the surrounding conditions, but a minimum 25-foot undisturbed vegetative buffer is needed for even the smallest perennial streams, and a 50-foot or larger undisturbed buffer is ideal. Even with a 25-foot undisturbed buffer, additional zones can be added to extend the total buffer to at least 75 feet from the edge of the stream. The three distinct zones within the 75-foot depth are shown in Figure 5.4. The function, vegetative target and allowable uses vary by zone as described in Table 5.2.

These recommendations are minimum standards for most streams. Some streams and watersheds may benefit from additional measures to ensure adequate protection. In some areas, specific state laws or local ordinances already require stricter buffers than are described here. The buffer widths discussed are not intended to modify or supersede wider or more restrictive buffer requirements that are already in place.

As stated above, the streamside or inner zone should consist of a minimum of 25 feet of undisturbed mature forest. In addition to runoff protection, this zone provides bank stabilization as well as shading and protection for the stream. This zone should also include wetlands and any critical habitats, and its width should be

Figure 5. 4: Three-zone stream buffer system (Source: Adapted from Schueler, 1995)

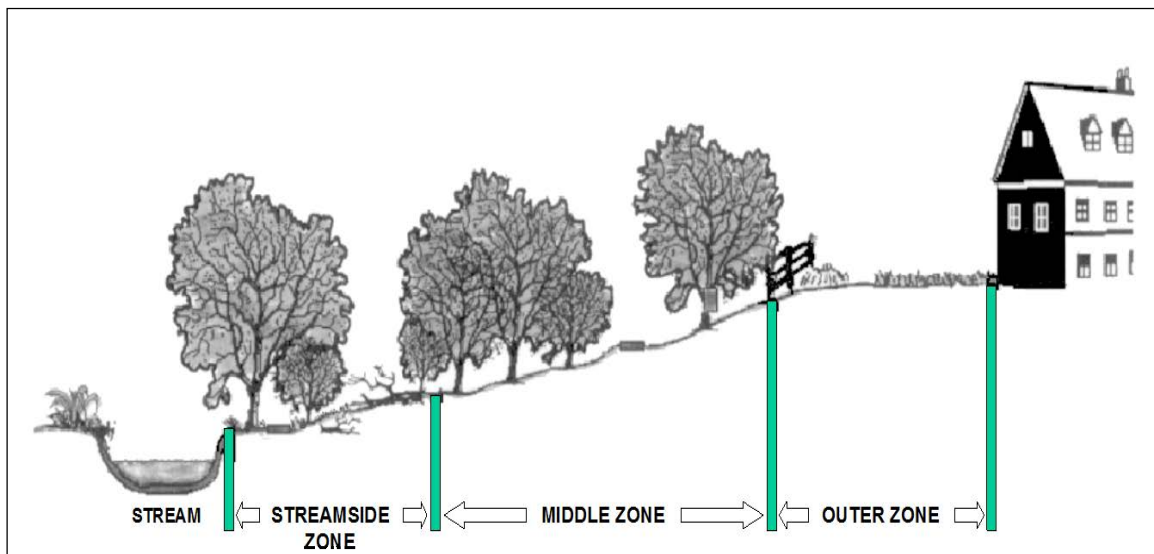

New York State Stormwater Management Design Manual

Chapter 5: Green Infrastructure Practices

Section 5.1 Planning for Green Infrastructure: Preservation of Natural Features and Conservation Design

adjusted accordingly. The middle zone provides a transition between upland development and the inner zone and should consist of managed woodland that allows for infiltration and filtration of runoff. An outer zone allows more clearing and acts as a further setback for impervious surfaces. It also functions to prevent encroachment and filter runoff. It is here that flow into the buffer should be transformed from concentrated flow into sheet flow to maximize ground contact with the runoff.

	Streamside Zone	Middle Zone	Outer Zone
Width	Minimum 25 feet plus wetlands and critical habitat	Variable, depending on stream order, slope, and 100-year floodplain (min. 25 ft.)	25-foot minimum setback from structures
Vegetative Target	Perennial grasses on steep slopes, undisturbed mature forest. Reforest if necessary.	Managed forest, some clearing allowed	Forest encouraged, but usually turfgrass
Allowable Uses	Very restricted (e.g., flood control, utility easements, footpaths)	Restricted (e.g., some recreational uses, some stormwater controls, bike paths)	Unrestricted (e.g., non-structural residential uses, including lawn, garden, most stormwater controls)

Development within the riparian buffer should be limited only to those structures and facilities that are absolutely necessary. Such limited development should be specifically identified in any codes or ordinances enabling the buffers. When construction activities do occur within the riparian corridor, specific mitigation measures should be required, such as deeper buffers or riparian buffer improvements.

Generally, the riparian buffer should remain in its natural state. However, some maintenance and management are periodically necessary, such as planting to minimize concentrated flow, removal of exotic plant species when these species are detrimental to the vegetated buffer and removal of diseased or damaged trees.

5.1.3 Reduction of Clearing and Grading

New York State Stormwater Management Design Manual

Chapter 5: Green Infrastructure Practices

Section 5.1 Planning for Green Infrastructure: Preservation of Natural Features and Conservation Design

Description: Clearing and grading of the site should be limited to the minimum amount needed for the development function, road access and infrastructure (e.g., utilities, wastewater disposal, stormwater management). Site foot-printing should be used to disturb the smallest possible land area on a site.

Key Benefits

- Preserves more undisturbed natural areas on a development site
- Areas of a site that are conserved in their natural state retain their natural hydrology and do not contribute to construction erosion
- Native trees, shrubs and grasses provide natural landscaping, reducing costs and contributing to the overall quality and viability of the environment.

Typical Perceived Obstacles and Realities

- Preserving trees during construction is expensive – *Minimizing clearing during construction can reduce earth movement and reduce erosion and sediment control costs*
- People prefer large lawns – *Lots with trees may have a higher value than those without*
- Preserved conservation areas may harbor nuisance wildlife, vegetation, and insects and may present safety hazards – *Once established, natural conservation areas must be protected during construction and managed after occupancy by a responsible party to maintain the areas in a natural state in perpetuity; proper management and maintenance will address nuisance and safety issues*

Using this Practice

- Restrict clearing to minimum reqd. for building footprints, construction access, and safety setbacks
- Establish limits of disturbance for all development activities
- Use site foot-printing to minimize clearing and land disturbance
- Avoid mass grading of a site – divide into smaller areas for phased grading
- Use conservation design, open-space or “cluster” developments
- Consult local planning authority for local clearing and grading regulations

Discussion

Minimal disturbance methods should be used to limit the amount of clearing and grading that takes place on a development site, preserving more of the undisturbed vegetation and natural hydrology of a site. A limit of disturbance (LOD) should be established based on the maximum disturbance zone. These maximum

New York State Stormwater Management Design Manual

Chapter 5: Green Infrastructure Practices

Section 5.1 Planning for Green Infrastructure: Preservation of Natural Features and Conservation Design

distances should reflect reasonable construction techniques and equipment needs, together with the physical situation of the development site, such as slopes or soils. LOD distances may vary by type of development, size of lot or site and by the specific development feature involved.

Site "foot-printing" should be used that maps all of the limits of disturbance to identify the smallest possible land area on a site which requires clearing or land disturbance. An example of site foot-printing is illustrated in Figure 5.5. Sites should be designed so that they fit the terrain (see Figure 5.6). During construction, special procedures and equipment that reduce land disturbance should be used. Alternative site designs should be considered to minimize limits of clearing, such as "cluster" developments (see section 5.1.5).

Figure 5.6 Example of site foot-printing (Source: Georgia Stormwater Manual, 2001)



Figure 5.6 Design plan showing limits of clearing (in dark shading) (Source: DDNREC, 1997)

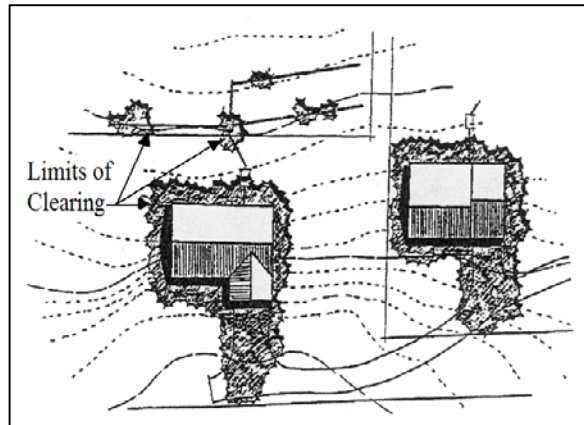

5.1.4 Locating Development in Less Sensitive Areas

Description: Development sites should be located to avoid sensitive resource areas such as floodplains, steep slopes, erodible soils, wetlands, mature forests and critical habitat areas. Buildings, roadways and parking areas should be located to fit the terrain and in areas that will create the least impact.

Key Benefits

- Preserving floodplains provides a natural right-of-way and temporary storage for large flood events; keeps people and structures out of harm's way and helps to preserve riparian ecosystems and habitats

New York State Stormwater Management Design Manual

Chapter 5: Green Infrastructure Practices

Section 5.1 Planning for Green Infrastructure: Preservation of Natural Features and Conservation Design

- Preserving steep slopes and building on flatter areas helps to prevent soil erosion and minimizes stormwater runoff; helps to stabilize hillsides and soils and reduces the need for cut-and-fill and grading
- Avoiding development on erodible soils can prevent sedimentation problems and water-quality degradation. Areas with highly permeable soils can be used as nonstructural stormwater infiltration zones
- Fitting the design to the terrain and in less sensitive areas helps to preserve the natural hydrology and drainageways of a site; reduces the need for grading and land disturbance, and provides a framework for site design and layout

Typical Perceived Obstacles and Realities

- Costs will be higher for developments due to increased planning and design, localized construction and less developable land – *Developments that protect sensitive areas may have higher market value, less liability for potential natural disasters, such as flooding or slope failures and lower construction costs for areas that require less earthwork or difficult terrain, such as steep slopes or wetland areas to work around*

Using this Practice

- Ensure all development activities do not encroach on, fill or alter designated floodplain and/or wetland areas
- Avoid development on steep slope areas and minimize grading and flattening of hills and ridges
- Leave wetlands, floodplains, and areas of porous or highly erodible soils as undisturbed conservation areas
- Develop roadway patterns to fit the site terrain, and locate buildings and impervious surfaces away from steep slopes, drainage ways and floodplains
- Locate sites in areas less sensitive to disturbance or have a lower value in terms of hydrologic function

Discussion

Development in floodplain areas can reduce the ability of the floodplain to convey stormwater, potentially causing safety problems or significant damage to the site in question, as well as to both upstream and downstream properties. The entire 100-year full-buildout floodplain should be avoided for clearing or building activities and should be preserved in a natural, undisturbed state. Where possible, the 500-year

New York State Stormwater Management Design Manual

Chapter 5: Green Infrastructure Practices

Section 5.1 Planning for Green Infrastructure: Preservation of Natural Features and Conservation Design

floodplain should also be preserved in a natural state and/or designated for parks, recreation or agriculture. Development on slopes with a grade of 15% or greater should be avoided, if possible, to limit soil loss, erosion, excessive stormwater runoff and the degradation of surface water. Excessive grading should be avoided on all slopes (Figure 5.7), as should the flattening of hills and ridges. Steep slopes should be kept in an undisturbed natural condition to help stabilize hillsides and soils. On slopes greater than 25%, no development, re-grading, or stripping of vegetation should be considered.

Figure 5.7 Cut and fill grading on steep slopes impacts larger areas than flatter slopes (Source: MPCA, 1989)

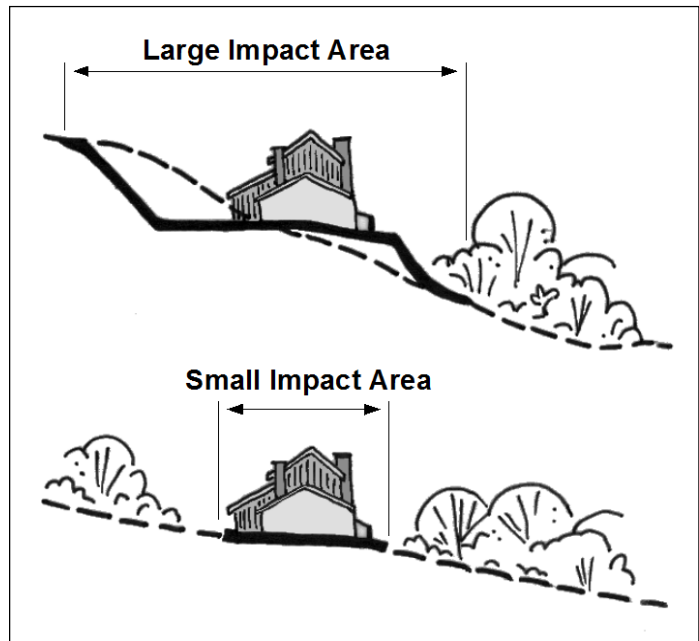

Areas of a site with hydrologic soil group A and B soils, (consult Natural Resources Conservation Service website for hydrological soil groups) such as sands and sandy loam soils, should be conserved as much as possible, and these areas should ideally be incorporated into undisturbed natural or open-space areas (Figure 5.8). Conversely, buildings and other impervious surfaces should be located on

Figure 5.8 Using soil mapping to guide development (Source: Georgia Stormwater Manual, 2001)

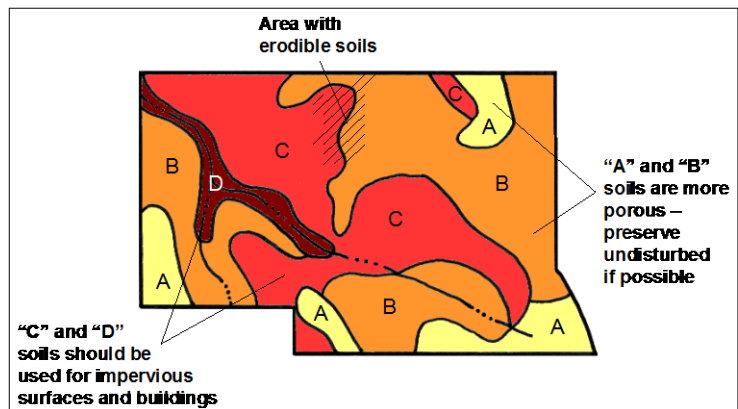

those portions of the site with the *least* permeable soils. Similarly, areas on a site with highly erodible or unstable soils should be avoided for land-disturbing activities and buildings to prevent erosion and sedimentation problems as well as potential structural problems. These areas should be left in an undisturbed and vegetated condition.

New York State Stormwater Management Design Manual

Chapter 5: Green Infrastructure Practices

Section 5.1 Planning for Green Infrastructure: Preservation of Natural Features and Conservation Design

Figure 5.9 Preserving the Natural topography of a Site (Source: Adapted from Prince George's County, 1999)

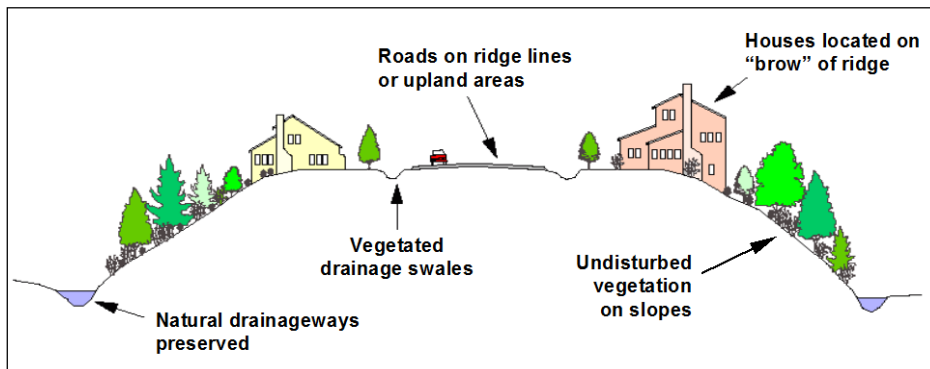

The layout of roadways and buildings on a site should generally conform to the landforms on a site (Figure 5.9). Natural drainage ways and stream buffer areas should be preserved by designing road layouts around them. Buildings should be sited to use the natural grading and drainage system and avoid the unnecessary disturbance of vegetation and soils.

Roadway patterns on a site should be chosen to provide access schemes which match the terrain. In rolling or hilly terrain, streets should be designed to follow natural contours to reduce clearing and grading. In flatter areas, a traditional grid pattern of streets or "fluid" grids which bend and may be interrupted by natural drainage ways may be more appropriate. In much the same way that a development should be designed to conform to the terrain of the site, layout should also be

Figure 5.10 Guiding development to less sensitive site areas (Source: Georgia Stormwater Manual, 2001)

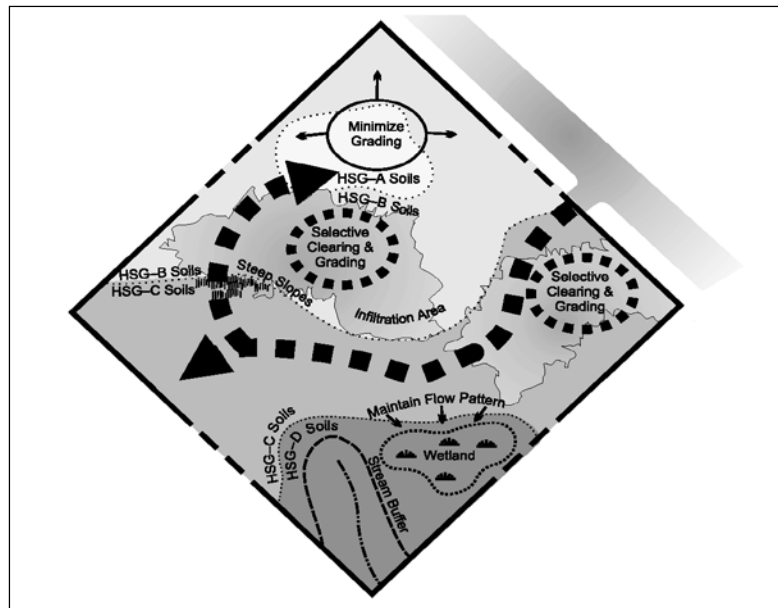

designed so that the areas of development are placed in the locations of the site that minimize the hydrologic impact of the project. This is accomplished by steering development to areas of the site that are less sensitive

New York State Stormwater Management Design Manual

Chapter 5: Green Infrastructure Practices

Section 5.1 Planning for Green Infrastructure: Preservation of Natural Features and Conservation Design

to land disturbance or have a lower value in terms of hydrologic function. Figure 5.10 shows a development site where the natural features have been mapped in order to delineate the hydrologically sensitive areas. Through careful site planning, sensitive areas can be set aside as natural open space areas. In many cases, such areas can be used as buffer spaces between land uses on or between adjacent sites.

5.1.5 Open Space Design

Description: Conservation development, clustering or open space design incorporates smaller lot sizes to reduce overall impervious cover while providing more undisturbed open space and protection of water resources.

Key Benefits

- Preserves conservation areas on a development site
- Can be used to preserve natural hydrology and drainageways
- Can be used to help protect natural conservation areas and other site features
- Reduces the need for grading and land disturbance
- Reduces infrastructure needs and overall development costs
- Allows flexibility to developers to implement creative site designs including better stormwater management practices

Typical Perceived Obstacles and Realities

- Smaller lot sizes and compact development may be perceived by developers as less marketable – *Open space designs can be highly desirable and have economic advantages such as cost savings and higher market appreciation*
- Lack of speed and certainty in the review process may be of concern – *Consult with the local review authority to review requirements; prospective homebuyers may be reluctant to purchase homes due to concerns regarding management of the community open space – Proper methods and implementation of maintenance agreements are available; natural open space reduces maintenance costs and can help keep association fees down*
- Cluster developments appear incompatible with adjacent land uses and are equated with increased noise and traffic – *Open space design allows preservation of natural areas, using less space for*

New York State Stormwater Management Design Manual

Chapter 5: Green Infrastructure Practices

Section 5.1 Planning for Green Infrastructure: Preservation of Natural Features and Conservation Design

streets, sidewalks, parking lots, and driveways; incorporating buffers into the design can help alleviate incompatibility with other competing land uses

Figure 5.11 Aerial view of an open space or “cluster” subdivision (Source: Georgia Stormwater Manual, 2001)



Using this Practice

- Use a site design which concentrates development and preserves open space and natural areas of the site
- Locate the developed portion of the cluster areas in the least sensitive areas of the site
- Consult with the municipality to find out whether there is a local law or ordinance for cluster development, open space design, conservation design or flexible subdivisions
- Where allowed by the municipality, utilize reduced setbacks and frontages, and narrower right-of-way widths to design non-traditional lot layouts within the cluster

Discussion

Conservation development, also known as “open space residential design” (OSRD), or clustering, is a green infrastructure planning technique that concentrates structures and impervious surfaces in a compact area in

Figure 5.12 Open space or “cluster” subdivision example (Source: Georgia Stormwater Manual, 2001)

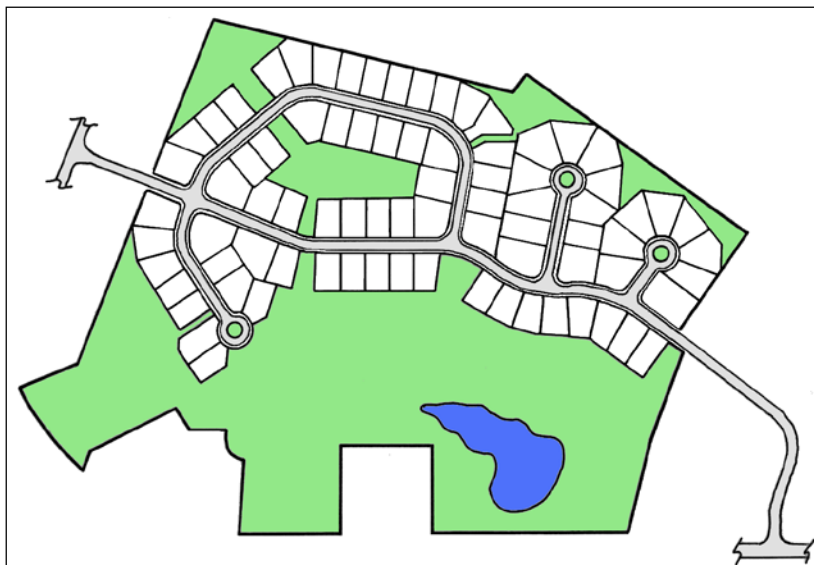

one portion of the development site in exchange for providing open space, natural areas or agricultural lands elsewhere on the site. Typically smaller lots and/or nontraditional lot designs are used to cluster development and create more conservation areas on the site.

Conservation development has many benefits compared with conventional development or residential subdivisions: this technique can reduce impervious

New York State Stormwater Management Design Manual

Chapter 5: Green Infrastructure Practices

Section 5.1 Planning for Green Infrastructure: Preservation of Natural Features and Conservation Design

cover, stormwater pollution, construction costs, and the need for grading and landscaping, while providing for the conservation of natural areas. Figures 5.11 and 5.12 show examples of open space developments.

Along with reduced imperviousness, conservation design provides a host of other environmental benefits lacking in most conventional designs. These developments reduce potential pressure to encroach on conservation and buffer areas because enough open space is usually reserved to accommodate these protection areas. As less land is cleared during the construction process, alteration of the natural hydrology and the potential for soil erosion are also greatly diminished. Perhaps most importantly, open space design reserves 25 to 50 percent of the development site in conservation areas that would not otherwise be protected.

Conservation development can also be significantly less expensive to build than conventional projects. Most of the cost savings are due to reduced infrastructure cost for roads and stormwater management controls and conveyances. While conservation developments are frequently less expensive to build, developers find that these properties often command higher prices than those in more conventional developments. Several studies estimate that residential properties in developments with open space garner premiums that are higher than conventional subdivisions and moreover, sell or lease at increased rates. Once established, common open space and natural conservation areas must be managed by a responsible party able to maintain the areas in a natural state in perpetuity. Typically, the conservation areas are protected by legally enforceable deed restrictions, conservation easements, and maintenance agreements. Flexible lot shapes and setback and frontage distances allow site designers to create attractive and unique lots that provide homeowners with enough space while allowing for the preservation of natural areas in a residential subdivision. A narrower Right-of-Way will consume less land that may be better used for housing lots, and allow for a more compact site design. Figures 5.13 and 5.14 illustrate various nontraditional lot designs.

Figure 5.13 Lots with reduced front and side setbacks

Figure 5.12 Nontraditional lot design (Source: ULI, 1992)

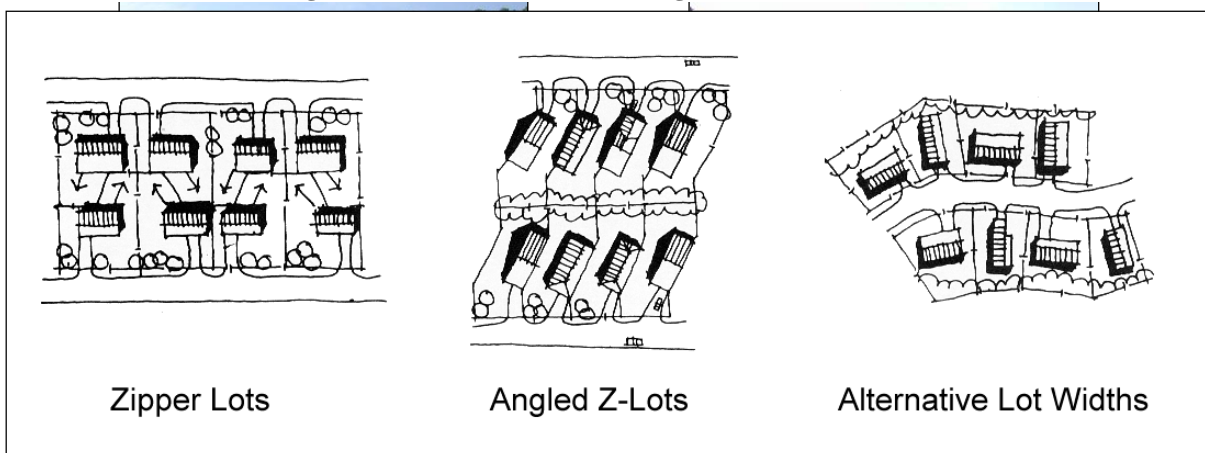

New York State Stormwater Management Design Manual

Chapter 5: Green Infrastructure Practices

Section 5.1 Planning for Green Infrastructure: Preservation of Natural Features and Conservation Design

References/Further Resources

- Arendt, Randall. 1994. *Designing Open Space Subdivisions: A Practical Step-by-Step Approach*. Natural Lands Trust, Inc. Media, PA. Available from www.natlands.org or www.greenerprospects.com
- Center for Watershed Protection. 1998. *Better Site Design: A Handbook for Changing Development Rules in Your Community*. Available from www.cwp.org
- Center for Watershed Protection. 1998. *Nutrient Loading from Conventional and Innovative Site Development*. Prepared for: Chesapeake Research Consortium. Center for Watershed Protection, Ellicott City, MD.
- Center for Watershed Protection. 2000. *Maryland Stormwater Manual, 2000* Maryland Department of the Environment. Available from http://www.mde.state.md.us/Programs/WaterPrograms/SedimentandStormwater/stormwater_design/index.asp
- Center for Watershed Protection. 2002. *The Vermont Stormwater Management Manual, Volume I – Stormwater Treatment Standards*. Vermont Agency of Natural Resources. April 2002. Available from: http://www.vtwaterquality.org/stormwater/docs/sw_manual-vol1.pdf
- City of Portland, Oregon. 2004. *Stormwater Management Manual*. Bureau of Environmental Services, Portland, OR. Available from <http://www.portlandonline.com/bes/>
- Flinker, P., H. Dodson, S. la Cour, H. Blanchette, K. Wilson, R Claytor, and N. Kelly. 2005. *The Urban Environmental Design Manual*. Rhode Island Department of Environmental Management, Providence, Rhode Island. Available from <http://www.dem.state.ri.us/programs/bpoladm/suswshed/pubs.htm>
- Harrington, B. W. 1987. *Design Procedures for Stormwater Management Extended Detention Structures*. Maryland Department of the Environment.
- Prince George's County, MD. 1999. *Low-Impact Development Design Strategies: An Integrated Design Approach*. Prince George's County, Maryland, Department of Environmental Resources, Largo, Maryland. Available from www.epa.gov

5.1.6 Soil Restoration

Description

Soil Restoration is a required practice applied across areas of a development site where soils have been disturbed and will be vegetated in order to recover the original properties and porosity of the soil. Healthy soil is vital to a sustainable environment and landscape. A deep, well drained soil, rich in organic matter, absorbs rainwater, helps prevent flooding and soil erosion, filters out water pollutants, and promotes vigorous plant growth that requires less irrigation, pesticides, and fertilizer.

Soil Restoration is applied in the cleanup, restoration, and landscaping phase of construction followed by the permanent establishment of an appropriate, deep-rooted groundcover to help maintain the restored soil structure. Soil restoration includes mechanical decompaction, compost amendment, or both.

Many runoff reduction practices need Soil Restoration measures applied over and adjacent to the practice to achieve runoff reduction performance. (See typical compacted soil in Figure 5.15). Consult individual profile sheets for specific design criteria.

Figure 5.14 Shows typical compacted soils that nearly reach the bulk density of concrete (Schueler et al 2000)



Key Benefits

- More marketable buildings and landscapes
- Less stormwater runoff, better water quality
- Healthier, aesthetically pleasing landscapes
- Increased porosity on redevelopment sites where impervious cover is converted to pervious
- Achieves performance standards on runoff reduction practices
- Decreases runoff volume generated and lowers the demand on runoff control structures
- Enhances direct groundwater recharge
- Promotes successful long-term revegetation by restoring soil organic matter, permeability, drainage and water holding capacity for healthy root system development of trees, shrubs and deep-rooted ground covers, minimizing lawn chemical requirements, plant drowning during wet periods, and burnout during dry periods

Typical Perceived Obstacles and Realities

New York State Stormwater Management Design Manual

Chapter 5: Green Infrastructure Practices

Section 5.1 Planning for Green Infrastructure: Preservation of Natural Features and Conservation Design

- Higher cost due to soil restoration- *application of soil de-compaction and enhancement may have additional initial cost; however, they provide benefit in reducing the need for conveyance structures.*
- Space constraints and obstruction for use of equipment - *post construction space may limit the ability of some of the de-compaction equipment, however, alternative equipment and sensible planning help overcome this obstacle.*

Discussion

Tilling exposes compacted soil devoid of oxygen to air and recreates temporary air space. In addition, research has shown that the incorporation of organic compost, can greatly improve temporary water storage in the soil and subsequent runoff reduction through infiltration and evapotranspiration.

Soils that have a permanent high water table close to the surface (0-12 inches), either influenced by a clay or other highly impervious layer of material, may have bulk densities so naturally high that compaction has little added impact on infiltration (Lacey 2008). However, these soils will still benefit from the addition of compost. The water holding capacity, penetration, structural stability, and fertility of clay soils were improved with compost mixing (Avnimelech and Cohen 1988).

Table 5.3 describes various soil disturbance activities related to land development, soil types and the requirements for soil restoration for each activity. Soil Restoration or modification of curve numbers is a required practice. Restoration is applied across areas of a development site where soils have been compacted and will be vegetated according to the criteria defined in Table 5.3. If Soil Restoration is not applied according to these criteria, designers are required to:

- a) Increase the calculated WQv by factoring in the compacted areas that have not been kept as impervious cover (including areas of cut or fill, heavy traffic areas on site, or Impervious Cover reduction in redevelopment projects unless aeration or full soil restoration is applied, per Table 5.3).
- b) Change by one level the post-construction hydrologic soil group (HSG) to a less permeable group than the original condition. This is applied to all volumetric and discharge rate control computations.

New York State Stormwater Management Design Manual

Chapter 5: Green Infrastructure Practices

Section 5.1 Planning for Green Infrastructure: Preservation of Natural Features and Conservation Design

Table 5.3 Soil Restoration Requirements			
Type of Soil Disturbance	Soil Restoration Requirement		Comments/Examples
No soil disturbance	Restoration not permitted		Preservation of Natural Features
Minimal soil disturbance	Restoration not required		Clearing and grubbing
Areas where topsoil is stripped only - no change in grade	HSG A & B	HSG C&D	Protect area from any ongoing construction activities.
	apply 6 inches of topsoil	Aerate* and apply 6 inches of topsoil	
Areas of cut or fill	HSG A & B	HSG C & D	
	Aerate and apply 6 inches of topsoil	Apply full Soil Restoration **	
Heavy traffic areas on site (especially in a zone 5-25 feet around buildings but not within a 5 foot perimeter around foundation walls)	Apply full Soil Restoration (de-compaction and compost enhancement)		
Areas where Runoff Reduction and/or Infiltration practices are applied	Restoration not required, but may be applied to enhance the reduction specified for appropriate practices.		Keep construction equipment from crossing these areas. To protect newly installed practice from any ongoing construction activities construct a single phase operation fence area
Redevelopment projects	Soil Restoration is required on redevelopment projects in areas where existing impervious area will be converted to pervious area.		

*Aeration includes the use of machines such as tractor-drawn implements with coulters making a narrow slit in the soil, a roller with many spikes making indentations in the soil, or prongs which function like a mini-subsoiler.

** Per “Deep Ripping and De-compaction, DEC 2008”.

Using this Practice

During periods of relatively low to moderate subsoil moisture, the disturbed subsoils are returned to rough grade and the following Soil Restoration steps applied:

- 1) Apply 3 inches of compost over subsoil

New York State Stormwater Management Design Manual

Chapter 5: Green Infrastructure Practices

Section 5.1 Planning for Green Infrastructure: Preservation of Natural Features and Conservation Design

- 2) Till compost into subsoil to a depth of at least 12 inches using a cat-mounted ripper, tractor-mounted disc, or tiller, mixing, and circulating air and compost into subsoils
- 3) Rock-pick until uplifted stone/rock materials of four inches and larger size are cleaned off the site
- 4) Apply topsoil to a depth of 6 inches
- 5) Vegetate as required by approved plan.

At the end of the project an inspector should be able to push a 3/8" metal bar 12 inches into the

soil just with body weight. Figures 5.16 and 5.17 show two attachments used for soil decompaction. Tilling (step 2 above) should not be performed within the drip line of any existing trees or over utility installations that are within 24 inches of the surface.

COMPOST SPECIFICATIONS

Compost shall be aged, from plant derived materials, free of viable weed seeds, have no visible free water or dust produced when handling, pass through a half inch screen and have a pH suitable to grow desired plants.

Maintenance

A simple maintenance agreement should identify where Soil Restoration is applied, where newly restored areas are/cannot be cleared, who the responsible parties are to ensure that routine vegetation improvements are made (i.e., thinning, invasive plant removal, etc.). Soil compost amendments within a filter strip or grass channel should be located in public right of way, or within a dedicated stormwater or drainage easement.

First year maintenance operations includes:

- Initial inspections for the first six months (once after each storm greater than half- inch)

Figure 5.15 Soil aerator implement



Figure 5.16 Soil aerator implement



New York State Stormwater Management Design Manual

Chapter 5: Green Infrastructure Practices

Section 5.1 Planning for Green Infrastructure: Preservation of Natural Features and Conservation Design

- Reseeding to repair bare or eroding areas to assure grass stabilization
- Water once every three days for first month, and then provide a half inch of water per week during first year. Irrigation plan may be adjusted according to the rain event.
- Fertilization may be needed in the fall after the first growing season to increase plant vigor
- Ongoing Maintenance:

Two points help ensure lasting results of decompaction:

- 1) Planting the appropriate ground cover with deep roots to maintain the soil structure
- 2) Keeping the site free of vehicular and foot traffic or other weight loads. Consider pedestrian footpaths. (Sometimes it may be necessary to de-thatch the turf every few years)

References/Further Resources

Avnimelech, Y. and M. Kochva, Y. Yotal, D. Shkedy. 1988. *THE USE OF COMPOST AS A SOIL AMENDMENT*

Balusek. 2003. Quantifying decreases in stormwater runoff from deep-tilling, chisel-planting and *compost amendments*. Dane County Land Conservation Department. Madison, Wisconsin.
<http://www.countyofdane.com/lwr/landconservation/papers/quantifyingdecreasesinswrunoff.pdf>

Chollak, T. and P. Rosenfeld. 1998. Guidelines for Landscaping with Compost-Amended Soils City of Redmond Public Works.
<http://www.ci.redmond.wa.us/insidecityhall/publicworks/environment/pdfs/compostamendedsoils.pdf>

City of Portland. 2008. Soil Specification for Vegetated Stormwater Facilities. Portland Stormwater Management Manual. Portland, Oregon

Composting Council (TCC). 1997. Development of a landscape architect specification for *compost utilization*. Alexandria, VA. <http://www.cwc.org/organics/org972rpt.pdf>

DRAFT VA DCR STORMWATER DESIGN SPECIFICATION No. 4, SOIL COMPOST AMENDMENT, VERSION 1.5 June 22, 2009

<http://www.chesapeakestormwater.net/storage/first-draft-baywide-design-specifications/BAYWIDE%20No%204%20SOIL%20AMENDMENT%20SPECIFICATION.pdf>

Holman-Dodds, L. 2004. Chapter 6. Assessing infiltration-based stormwater practices. PhD Dissertation. Department of Hydroscience and Engineering. University of Iowa. Iowa City, IA.

King County Department of Development & Environmental Services, *Achieving the Post-construction Soil Standard*, January 1, 2005. <http://www.metrokc.gov/DDES/forms/1s-inf-SoilPost-ConStd.pdf>

New York State Stormwater Management Design Manual

Chapter 5: Green Infrastructure Practices

Section 5.1 Planning for Green Infrastructure: Preservation of Natural Features and Conservation Design

Lacey, John. 2008. NYSDEC Deep-Ripping and Decompaction , *Guidelines for Infiltration and De-compaction*, New York State Department of Environmental Conservation.

Lenhart, J. 2007. Compost as a soil amendment for water quality treatment facilities. Proceedings 2007 LID Conference. Wilmington, NC

Low Impact Development Center. *Guideline for Soil Amendments*.
<http://www.lowimpactdevelopment.org/epa03/soilamend.htm>

NYS Dept. of Ag & Markets <http://www.agmkt.state.ny.us/AP/agsservices/constructG8.html>

Roa-Espinosa. 2006. An introduction to soil compaction and the subsoiling practice. technical note. Dane County Land Conservation Department. Madison, Wisconsin.

Schueler, T. 2000. “*The Compaction of Urban Soils*” *The Practice of Watershed Protection*. P. 210-214. Center for Watershed Protection

SERAIEG, Southern Extension and Research Activity Information Exchange Group, Interpreting Soil Organic Matter Tests, (2005). http://www.clemson.edu/agrvlb/sera6/SERA6-ORGANIC_doc.pdf

Soils for Salmon. 2003. Soil Restoration and compost amendments.
<http://www.soilsforsalmon.org/pdf/SoilsforSalmonLIDrev9-16-04.pdf>

US Composting Council, www.compostingcouncil.org

Section 5.2 Planning for Green Infrastructure: Reduction of Impervious Cover

Once sensitive resource areas and site constraints have been avoided, the next step is to minimize the impact of land alteration by reducing impervious areas. Reduction of impervious cover includes methods to reduce the amount of rooftops, parking lots, roadways, sidewalks and other surfaces that do not allow rainfall to infiltrate into the soil, in order to reduce the volume of stormwater runoff, increase groundwater recharge, and reduce pollutant loadings that are generated from a site. See Table 5.4 for a list of the impervious cover reduction techniques described in the detailed practice sheets in this section.

Table 5.4 Planning Practices for Reduction of Impervious Cover	
Practice	Description
Roadway Reduction	Minimize roadway widths and lengths to reduce site impervious area
Sidewalk Reduction	Minimize sidewalk lengths and widths to reduce site impervious area
Driveway Reduction	Minimize driveway lengths and widths to reduce site impervious area
Cul-de-sac Reduction	Minimize the number of cul-de-sacs and incorporate landscaped areas to reduce their impervious cover.
Building Footprint Reduction	Reduce the impervious footprint of residences and commercial buildings by using alternate or taller buildings while maintaining the same floor to area ratio.
Parking Reduction	Reduce imperviousness on parking lots by eliminating unneeded spaces, providing compact car spaces and efficient parking lanes, minimizing stall dimensions, using porous pavement surfaces in overflow parking areas, and using multi-storied parking decks where appropriate.

New York State Stormwater Management Design Manual

Chapter 5: Green Infrastructure Practices

Section 5.2 Planning for Green Infrastructure: Reduction of Impervious Cover

5.2.1 Roadway Reduction

Description: Roadway lengths and widths should be minimized on a development site where possible to reduce overall imperviousness.

Key Benefits

- Reduces the amount of impervious cover and associated runoff and pollutants generated
- Reduces the costs associated with road construction and maintenance

Typical Perceived Obstacles and Realities

- Local codes may not permit shorter or narrower roads – *Meet with local officials to discuss waivers for alternative designs that will address concerns of access, snow stockpiling, and parking*
- The public may view narrow roads as unsafe – *Narrower roads in fact reduce the speeds at which vehicles drive; many maintenance and emergency vehicles can in fact access narrow roads*
- Narrow and shorter roads do not have enough parking – *Provisions can be made in the design of a site to accommodate off-street parking*

Using this Practice

- Consider different site and road layouts that reduce overall street length
- Minimize street width by using narrower street designs that are a function of land use, density and traffic demand
- Use smaller side-yard setbacks to reduce total road length
- Consult with local highway and planning officials to determine if narrower roads and smaller setbacks are accepted or whether waivers or variances will be needed

Discussion

The use of alternative road layouts that reduce the total length of roadways can significantly reduce overall imperviousness of a development site. Site designers are encouraged to analyze different site and roadway layouts to see if they can reduce overall street length.

New York State Stormwater Management Design Manual

Chapter 5: Green Infrastructure Practices

Section 5.2 Planning for Green Infrastructure: Reduction of Impervious Cover

Figure 5.17 Potential design options for narrower roadway widths

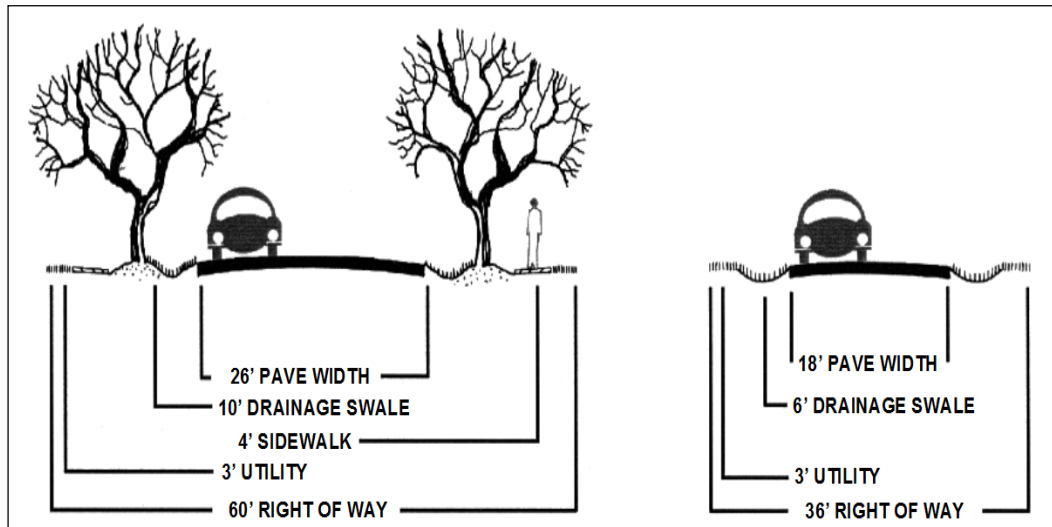

In addition, residential streets and private streets within commercial and other development should be designed for the minimum required pavement width needed to support travel lanes, on-street parking and emergency access. Figure 5.18 shows options for narrower street designs. In many instances, on-street parking can be reduced to one lane or eliminated on local access roads with less than 200 average daily trips (ADT) and on short cul-de-sacs street. One-way, single-lane, loop roads are another way to reduce the width of lower-traffic streets.

County public works and highway departments in New York State as well as the New York State Department of Transportation use the American Association of State Highway Transportation Officials (AASHTO) recommendations for road design. AASHTO recommends that for low volume local roads with less than 400 average daily trips and design speeds of 40 mph or less, the width of the traveled way can be as little as 18 feet. Adding two-foot shoulders on either side, the total would be 22 feet. For larger volume roads, widths would be increased accordingly. See Figure 5.18. Further, reducing side yard setbacks and using narrower frontages can reduce total street length, which is especially important in cluster and open-space designs.

New York State Stormwater Management Design Manual

Chapter 5: Green Infrastructure Practices

Section 5.2 Planning for Green Infrastructure: Reduction of Impervious Cover

Table 5.5 Minimum Width of Traveled Way (Feet) for Specified Design Volume				
Design speed (miles per hour)	Under 400	400 to 1500	1500 to 2000	Over 2000
15	18	20 ¹	20	22
20	18	20 ¹	22	24 ³
25	18	20 ¹	22	24 ³
30	18	20 ¹	22	24 ³
40	18	20 ¹	22	24 ³
45	20	22	22	24 ³
50	20	22	22	24 ³
55	22	22	24 ³	24 ³
60	22	22	24 ³	24 ³
Width of graded shoulder on each side of road (feet)				
All speeds	2	5 ^{1,2}	6	8

¹ For roads in mountainous terrain with design volume of 400 to 600 vehicles/day, use 18-foot traveled way width and 2-foot shoulder width.

² May be adjusted to achieve a minimum roadway width of 30 feet for design speeds greater than 40 mph.

³ Where the width of the traveled way is shown as 24 feet, the width may remain at 22 feet on reconstructed highways where alignment and safety records are satisfactory.

From: A Policy on Geometric Design of Highways and Streets, (Exhibit 5-5. Minimum Width of Traveled Way and Shoulders) 2004, by the American Association of State Highway and Transportation Officials, Washington, D.C. Used by permission.

5.2.2 Sidewalk Reduction

Description: Sidewalk lengths and widths should be minimized on a development site where possible to reduce overall imperviousness.

Key Benefits

- Reduces the amount of impervious cover and associated runoff and pollutants generated
- Reduces the costs associated with construction and maintenance
- Reduces the individual homeowner's responsibility for maintenance, such as snow clearance

Typical Perceived Obstacles and Realities

- Sidewalks on only one side of the street may be perceived as unsafe – *Accident research shows sidewalks on one side are nearly as safe as sidewalks on both*
- Homebuyers are perceived to want sidewalks on both sides – *Some actually prefer not to have a sidewalk in front of their home, and there is no market difference between homes with and without sidewalks directly in front.*
- Local codes may not permit narrower, alternative, or the elimination of a sidewalk – *Meet with local officials to discuss waivers for alternative designs that will address concerns of accessibility and safety issues.*

Using this Practice

- Locate sidewalks on only one side of the street where applicable (may not apply in downtown and village areas where walkability is important)
- Provide common walkways linking pedestrian areas
- Use alternative sidewalk and walkway surfaces
- Shorten front setbacks to reduce walkway lengths
- Consult with local highway and planning officials to determine if alternative sidewalk designs and paving materials are allowed or whether waivers or variances will be needed

Discussion

Most local codes require that sidewalks be placed on both sides of residential streets (e.g., double sidewalks) and be constructed of impervious concrete or asphalt. For state and federally-funded projects, the standard width of a sidewalk is 5 feet. Many subdivision codes also require sidewalks to be 4 to 6 feet wide and 2 to 10 feet from the street. These codes are enforced to provide sidewalks as a safety measure.

New York State Stormwater Management Design Manual

Chapter 5: Green Infrastructure Practices

Section 5.2 Planning for Green Infrastructure: Reduction of Impervious Cover

Developers may wish to consider allowing sidewalks on only one side of the street or eliminating them where they don't make sense. Sidewalks should be designed with the goal of improving pedestrian movement and diverting it away from the street. Developers may also consider reducing sidewalk widths and placing them farther from the street. In addition, sidewalks should be graded to drain to front yards rather than the street, or planters could be used as filters placed between sidewalk and road.

Alternative surfaces for sidewalks and walkways should be considered to reduce impervious cover (Figure 5.19). In addition, building and home setbacks should be shortened to reduce the amount of impervious cover from entry walks.

Figure 5.18 Sidewalk with common walkways linking pedestrian areas (Source: MA EOE, 2005)



5.2.3 Driveway Reduction

Description: Driveway lengths and widths should be minimized on a development site where possible to reduce overall imperviousness.

Key Benefits

- Reduces the amount of impervious cover and associated runoff and pollutants generated

Typical Perceived Obstacles and Realities

- Alternative driveway surfaces make snow removal more difficult – *Careful site design, material selection and homeowner education can help alleviate the concern*
- Developers perceive alternative surfaces as less marketable – *“Green” development projects are increasingly being sought by consumer.*
- Homeowners have concerns regarding access with shared driveways – *Proper site design, shared driveway agreements¹ and homeowner education will alleviate access issues*
- Local codes may not permit shorter or narrower driveways or driveways with porous surfaces – *Meet with local officials to discuss waivers for alternative designs*

Figure 5.19 Reduced driveway lengths by using shared driveways (Source: MA EOE, 2005)



Using this Practice

- Use shared driveways that connect two or more homes
- Use alternative driveway surfaces

¹ For a model shared driveway agreement see, "Town of Clinton: Recommended Model Development Principles for Conservation of Natural Resources in the Hudson River Estuary Watershed; Appendix 2," 2006 at <http://www.townofclinton.com/pdf/ClintonBSDrev8.pdf>

New York State Stormwater Management Design Manual

Chapter 5: Green Infrastructure Practices

Section 5.2 Planning for Green Infrastructure: Reduction of Impervious Cover

- Use smaller lot front building setbacks to reduce total driveway length
- Use shared driveway agreements for maintenance
- Consult with local highway and planning officials to determine if alternative driveway designs and paving materials are allowed or whether waivers or variances will be needed

Figure 5.20 Permeable pavers as an alternative driveway surface



Discussion

Most local subdivision codes are not very explicit as to how driveways must be designed. Most simply require a standard apron to connect the street to the driveway but don't specify width or surface material. Typical residential driveways range from 12 feet wide for one-car driveways to 20 feet for two. While shared driveways are discouraged or prohibited by many communities, they can reduce impervious cover and should be encouraged with enforceable maintenance agreements and easements (Figure 5.20).

The typical 400-800 square feet of impervious cover per driveway can be minimized by using narrower driveway widths, reducing the length of driveways, or using alternative surfaces such as double-tracks, reinforced grass or permeable paving materials (Figure 5.21).

Building and home setbacks should be shortened to reduce the amount of impervious cover from driveways and entry walks. A setback of 20 feet is more than sufficient to allow a car to park in a driveway without encroaching into the public right of way and reduces driveway and walk pavement by more than 30 percent compared with a setback of 30 feet (see Figure 5.22).

Figure 5.21 Reduced driveway and walkway lengths by using reduced setbacks (Adapted from: MPCA, 1989)

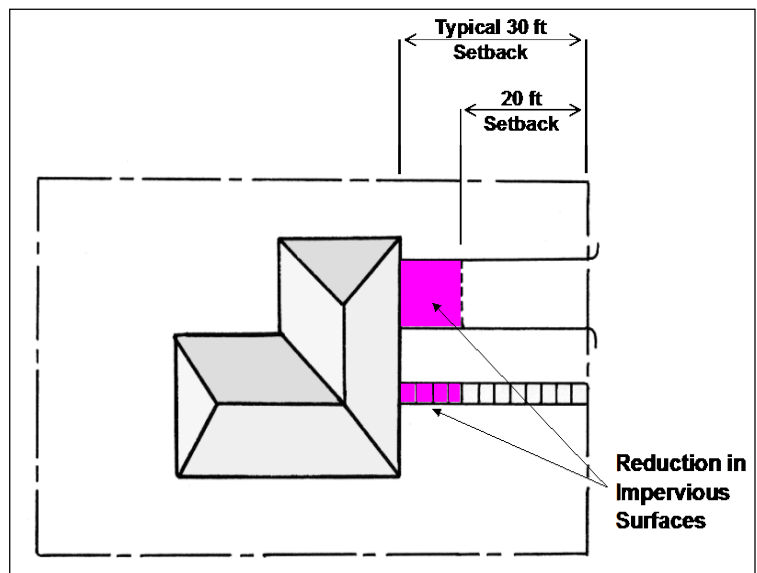

5.2.4 Cul-de-sac Reduction

Description: Minimize the number of cul-de-sacs and incorporate landscaped areas to reduce their impervious cover. The radius of a cul-de-sac should be the minimum required to accommodate emergency and maintenance vehicles. Alternative turnarounds should also be considered.

Key Benefits

- Reduces the amount of impervious cover, associated runoff and pollutants generated
- Increases aesthetics by allowing for natural or landscaped areas rather than pavement

Typical Perceived Obstacles and Realities

- Emergency and maintenance vehicles require a large turning radius – *Many newer vehicles are available with small turning radii*
- School buses require a large turning radius - *Verify school bus pick-up plans. Not every cul-de-sac will need to accommodate school bus turning radii*
- Homeowners like the “end of the road” appeal of cul-de-sacs – *This appeal can be accommodated using loop roads or lots that back onto open space areas*
- Local codes may not permit smaller or alternative cul-de-sac designs – *Meet with local officials to discuss waivers for alternative designs that will address concerns of access*

Using this Practice

- Reduce the radius of the turnaround bulb or consider alternative cul-de-sac design, such as “tee” turn-a-rounds or looping lanes
- Apply site design strategies that minimize dead-end streets
- Create a pervious island or a stormwater bioretention area in the cul-de-sac center to reduce impervious area
- Consult with local highway and planning officials to determine if alternative cul-de-sac designs are allowed or whether waivers or variances will be needed

Discussion

Alternative turnarounds are end of the street designs that replace fully-paved cul-de-sacs and reduce the amount of impervious cover created in developments. Cul-de-sacs are local access streets with a closed circular end that allows for vehicle turnarounds. Many of these cul-de-sacs can have a radius of more than 40 feet. From a stormwater perspective, cul-de-sacs create a huge bulb of impervious cover, increasing the

New York State Stormwater Management Design Manual

Chapter 5: Green Infrastructure Practices

Section 5.2 Planning for Green Infrastructure: Reduction of Impervious Cover

amount of runoff. For this reason, reducing the size of cul-de-sacs through the use of alternative turnarounds or eliminating them altogether can reduce the amount of impervious cover created at a site.

Numerous alternatives create less impervious cover than the traditional 40-foot cul-de-sac. These alternatives include reducing cul-de-sacs to a 30-foot radius and creating hammerheads, loop roads and pervious islands in the cul-de-sac center (see Figures 5.23, 5.24 and 5.25 below).

Sufficient turnaround area is a significant factor to consider in the design of cul-de-sacs. In particular, the types of vehicles entering the cul-de-sac should be considered. Fire trucks, service vehicles and school buses are often cited as needing large turning radii. However, some fire trucks are designed for smaller turning radii. In addition, many newer large service vehicles are designed with a tri-axle (requiring a smaller turning radius), and many school buses usually do not enter individual cul-de-sacs.

Figure 5.23 T-shaped turnaround option
(Source: Center for Watershed Protection, 2005)



Figure 5.23 Loop road option (Source: Center for Watershed Protection, 2005)



Another option for designing cul-de-sacs involves the placement of a pervious island in the center. Vehicles only travel along the outside of the cul-de-sac when turning, leaving an unused “island” of pavement in the center. These islands can be attractively landscaped and also designed as bioretention areas to treat stormwater (see section 6.4 of this Manual).

The most recent AASHTO guidelines should be used for cul-de-sac and alternative turnaround designs, and the design should create no more impervious surface than specified in the AASHTO guidelines.

New York State Stormwater Management Design Manual

Chapter 5: Green Infrastructure Practices

Section 5.2 Planning for Green Infrastructure: Reduction of Impervious Cover

Figure 5.24 Types of cul-de-sacs and dead-end streets

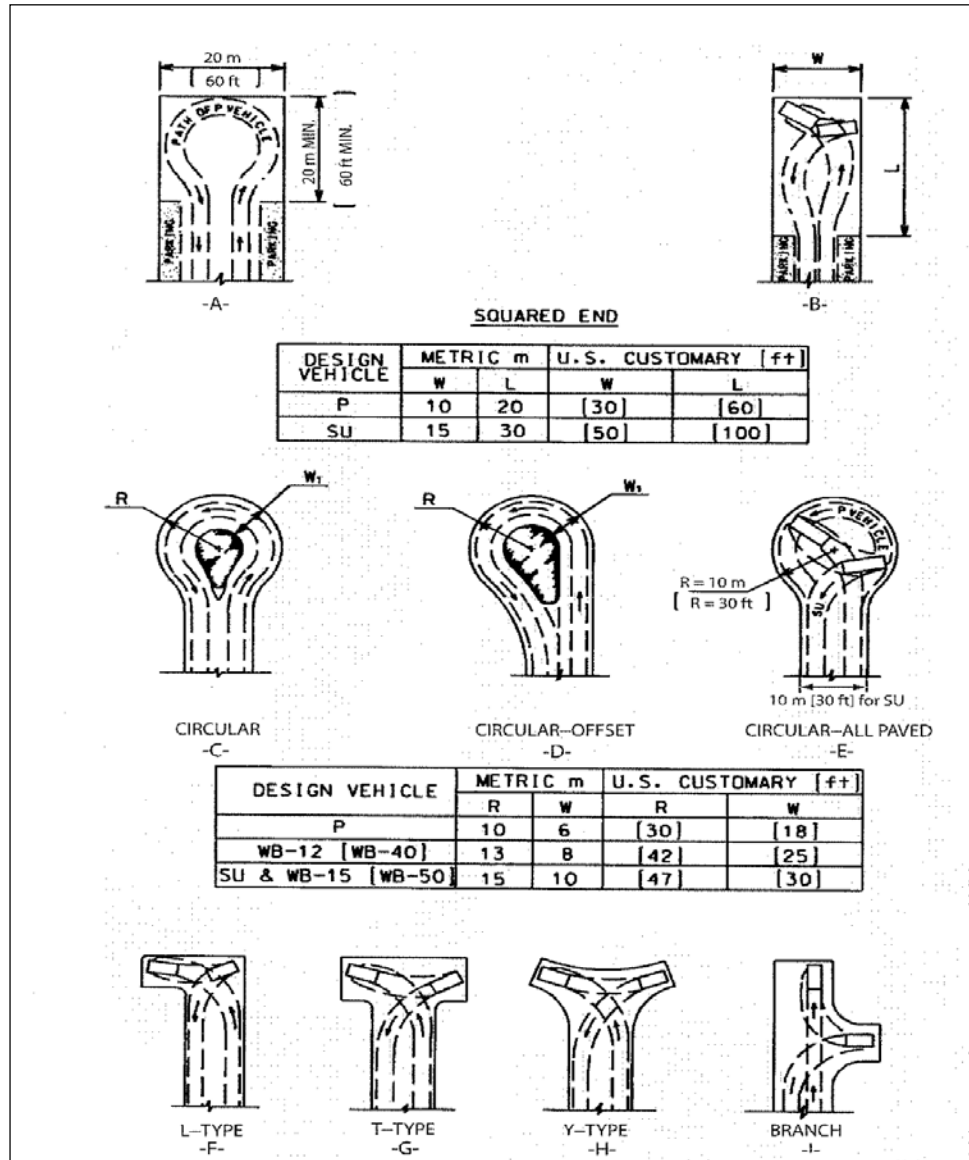

From: A Policy on Geometric Design of Highways and Streets, 2004, by the American Association of State Highway and Transportation Officials, Washington, D.C. Used by permission.

P = Passenger Car

SU = Single-Unit Truck

WB = Wheel Base - applies to semitrailer

New York State Stormwater Management Design Manual

Chapter 5: Green Infrastructure Practices

Section 5.2 Planning for Green Infrastructure: Reduction of Impervious Cover

5.2.5 Building Footprint Reduction

Description: The impervious footprint of residences and commercial buildings can be reduced by using alternate or taller buildings while maintaining the same floor-to-area ratio.

Key Benefits

- Reduces the amount of impervious cover and associated runoff and pollutants generated

Typical Perceived Obstacles and Realities

- Taller buildings are perceived to have higher construction and maintenance costs – *Costs for taller buildings and associated parking may be offset by reduced land and construction and maintenance costs*
- Local codes may not permit taller buildings – *Consider alternative locations that do allow taller buildings, or meet with local officials to discuss waivers for alternative designs*

Using this Practice

- Use alternate or taller building designs to reduce the impervious footprint of buildings.
- Consolidate functions and buildings or segment facilities to reduce footprints of structures.
- Reduce directly connected impervious areas.
- Consult with local planning officials to determine allowed building heights and whether variances will be needed for alternative designs.

Discussion

In order to reduce the imperviousness associated with the footprint and rooftops of buildings and other structures, alternative and/or vertical (taller) building designs should be considered. Consolidate functions and buildings, as required, or segment facilities to reduce the footprint of individual structures. Figure 5.26 shows the reduction in impervious footprint by using a taller building design, and Figures 5.27 and 5.28 show residential examples of reduced footprints.

New York State Stormwater Management Design Manual

Chapter 5: Green Infrastructure Practices

Section 5.2 Planning for Green Infrastructure: Reduction of Impervious Cover

Figure 5.25 Reduction of impervious cover by building up rather than out

(Source: Georgia Stormwater Manual, 2001)

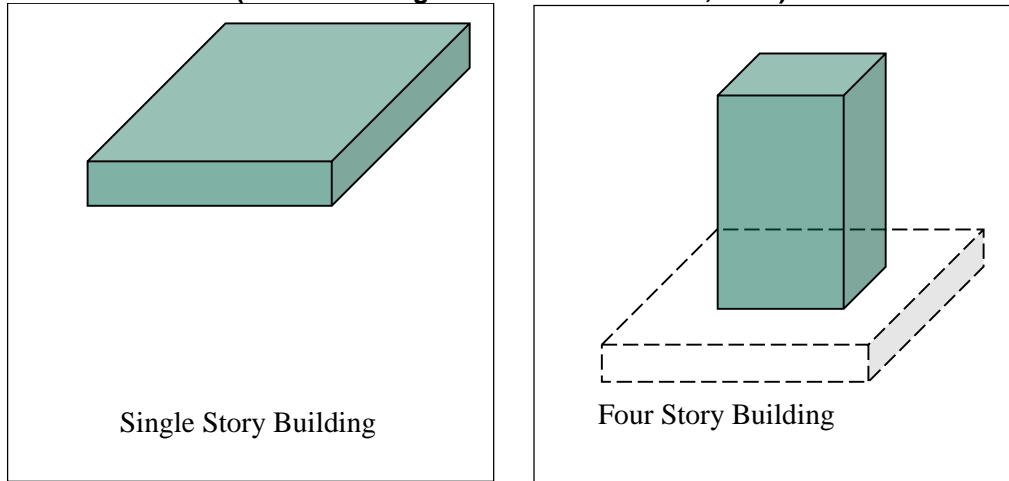

Figure 5.27 Taller houses create a smaller impervious footprint (Source: Center for Watershed Protection, 2005)



Figure 5.27 Taller apartments create a smaller impervious footprint (Source: City of Portland, OR, 2001)



5.2.6 Parking Area Reduction

Description: Reduce the overall imperviousness associated with parking lots by eliminating unneeded spaces, providing compact car spaces, minimizing stall dimensions, incorporating efficient parking lanes, using multi-storied parking decks and using porous paver surfaces or porous concrete in overflow parking areas where feasible.

Key Benefits

- Reduces the amount of impervious cover, associated runoff and pollutants generated
- Reduces construction costs, long-term operation and maintenance costs, and the need for larger stormwater facilities
- Improves aesthetics of an area by increasing vegetative surfaces and reducing the feeling of a large, paved urban area

Typical Perceived Obstacles and Realities

- Developers desire excess parking and fear losing customers during peaks – *Potential loss of customers due to reduced parking is unknown however, often times parking areas are not full during peak periods*
- Parking may spill over into residential or commercial areas when full – *Include preferential parking provisions for residents or parking enforcement with meters*
- Trend to larger vehicles such as SUVs – *Stall width requirements in most local parking codes are much larger than the widest SUVs*
- Structured parking is more expensive than surface lots – *Costs for structured parking may be offset by land costs or by constructing garages above or below an actual building*
- Porous pavement surfaces are more expensive to install and maintain – *Alternative surfaces may reduce the need for deicing treatments as well as alleviate the need for larger stormwater treatment elsewhere on the site*

Using this Practice

- Reduce the number of unnecessary parking spaces by examining minimum parking ratio requirements, and set a maximum number of spaces
- Reduce the number of un-needed parking spaces by examining the site's accessibility to mass transit
- Minimize individual parking stall dimensions, consulting local codes to determine if a waiver or variance is required

New York State Stormwater Management Design Manual

Chapter 5: Green Infrastructure Practices

Section 5.2 Planning for Green Infrastructure: Reduction of Impervious Cover

- Examine the traffic flow of the parking lot design to eliminate un-needed lanes / drive aisles
- Consider parking structures and shared parking arrangements between non-competing uses
- Use alternative porous surface for overflow areas or main parking areas if not a high-traffic parking lot
- Use landscaping or vegetated stormwater practices in parking lot islands
- Provide incentives for compact and hybrid cars

Discussion

Setting maximums for parking spaces, minimizing stall dimensions, using structured parking, encouraging shared parking, using alternative porous surfaces can all reduce parking footprint and site imperviousness. Some Planning Boards require that only a portion of the minimum parking spaces be constructed, and that space be provided to construct the remaining required spaces if needed.

Table 5.4: Conventional Minimum Parking Ratios
(Source: CWP, 1998; modified NYSDEC, 2010)

Land Use	Parking Requirement			Actual Average Parking Demand
	Parking Ratio	Typical Range	New York Example*	
Single family homes	2 spaces per dwelling unit	1.5–2.5	2 spaces per dwelling unit, plus 1 per auxiliary unit	1.11 spaces per dwelling unit
Shopping center	5 spaces per 1000 ft ² GFA	4.0–6.5	5.5 for > 2000 ft ² Net Floor Area	3.97 per 1000 ft ² GFA
Convenience store	3.3 spaces per 1000 ft ² GFA	2.0–10.0	7 per for < 2000 ft ² Net Floor Area	--
Industrial	1 space per 1000 ft ² GFA	0.5–2.0	1 space per employee	1.48 per 1000 ft ² GFA
Medical/dental office	5.7 spaces per 1000 ft ² GFA	4.5–10.0	6.7 per 1000 ft ² of net floor area	4.11 per 1000 ft ² GFA

GFA = Gross floor area of a building without storage or utility spaces,

*Town of Amherst Zoning Ordinance, net floor area is 0.75 to 0.9 of GFA, allows

for alternate parking plans (<http://www.amherst.ny.us/pdf/planning/compplan/zcrc/p7.pdf>)

New York State Stormwater Management Design Manual

Chapter 5: Green Infrastructure Practices

Section 5.2 Planning for Green Infrastructure: Reduction of Impervious Cover

Many parking lot designs result in far more spaces than actually required. This problem is exacerbated by a common practice of setting parking ratios to accommodate the highest hourly parking during the peak season. By determining average parking demand instead, a lower maximum number of parking spaces can be set to accommodate most of the demand. Table 5.6 provides examples of conventional parking requirements and compares them to average parking demand. In addition, the number of parking spaces needed may be reduced by a site's accessibility to public transportation.

Figure 5.28 Structured parking at an office park
(Source: Georgia Stormwater Manual, 2001)



Another technique to reduce the parking footprint is to minimize the dimensions of the parking spaces. This can be accomplished by reducing both the length and width of the parking stall. Parking stall dimensions can be further reduced if compact spaces are provided. Another method to reduce the parking area is to incorporate efficient parking lanes such as using one-way drive aisles with angled parking rather than the traditional two-way aisles.

Structured parking decks are another method for significantly reducing the overall parking footprint by minimizing surface parking. Figure 5.29 shows a parking deck used for a commercial development.

Shared parking in mixed-use areas and structured parking are techniques that can further reduce the conversion of land to impervious cover. A shared parking arrangement could include usage of the same parking lot by an office space that experiences peak parking demand during the weekday with a church that experiences parking demands during the weekends and evenings. Provide a written agreement for the parties to sign that specifies usage and maintenance.

Using alternative surfaces such as porous pavers or porous concrete is an effective way to reduce the amount of runoff generated by parking lots. They can replace conventional asphalt or concrete in both new

New York State Stormwater Management Design Manual

Chapter 5: Green Infrastructure Practices

Section 5.2 Planning for Green Infrastructure: Reduction of Impervious Cover

developments and redevelopment projects. Figure 5.30 is an example of porous pavers used at an overflow lot. Alternative pavers can also capture and treat runoff from other areas on the site.

When possible, expanses of parking should be broken up with landscaped islands at or below the grade of the parking area, with islands could include (see Figure 5.31) or management “islands” swales and bioretention snow removal, should not include end 5.3.2, 5.3.4, 5.3.3, 6.4

Figure 5.30 Expanses of parking area “Broken-Up” with Landscape Features



curb cuts. These shade trees and shrubs landscaped stormwater such as filter strips, areas. To facilitate landscaped islands of Trees. (see sections and 6.5 of this Manual).

Figure 5.29 Grass pavers for parking (Source: Georgia Stormwater Manual, 2001)



New York State Stormwater Management Design Manual

Chapter 5: Green Infrastructure Practices

Section 5.3 Green Infrastructure Techniques

Section 5.3 Green Infrastructure Techniques

Runoff Reduction is best achieved through the reduction of the effective impervious surface area of the catchment and minimization of disturbed area. This is particularly the case where pre-development soils demonstrate significant infiltration capacity. This section presents a series of green infrastructure principles and practices that can be incorporated in the site design to allow for micro management of runoff, promote groundwater recharge, increase losses through evapotranspiration and emulate the preconstruction hydrology, resulting in reduced water-quality-treatment volume.

Green infrastructure techniques utilize the natural features of the site and promote runoff reduction. By using these principles, the techniques in this Chapter provide an opportunity for distributed runoff control from individual sources, flow routing, infiltration, treatment and reduction of total water quality volume. Acceptable green infrastructure techniques are explained in this section of this Manual. A profile sheet for each practice provides associated description, performance criteria, design detail, sizing criteria, application, benefits, and limitations. The profile sheets identify the Required Elements of the design. Deviation from these requirements must be documented and justified.

The computation runoff reduction fall under two general methods. The first group of practices includes site design techniques that a designer could factor in by subtracting conserved areas from the total site area, resulting in reduced WQv and CPv. The second group of green infrastructure practices provides runoff reduction by storage of volume runoff and are computed accordingly. The following basic principles must be applied to all green infrastructure design applications:

- Each green infrastructure technique must be appropriately sized for its contributing drainage area.
- Contributing drainage areas, depending on final grading, flow path, impervious cover disconnection, and varying levels of micro management of the flow, may require sub-catchment delineation.
- For all green infrastructure techniques that involve infiltration, soil infiltration testing is required. Testing must be performed at the proposed practice site and follow the requirements in Appendix D.
- For all green infrastructure techniques that involve infiltration, adequate separation distance from ground water table and a reasonable drawdown time must be met.
- Green infrastructure techniques with storage capacity that are sited downstream from the developed areas must be sized for contributing areas (pervious and impervious covers), or sized for rainfall by run on.

New York State Stormwater Management Design Manual

Chapter 5: Green Infrastructure Practices

Section 5.3 Green Infrastructure Techniques

- Green infrastructure techniques without storage capacity that are sited downstream from the developed areas must be sized for receiving runoff from a maximum contributing area (pervious and impervious covers).
- Areas of green infrastructure techniques that do not receive runoff from developed areas can be subtracted from the contributing area of the downstream SMP for WQ_v calculation. The R_v of the SMP is calculated based on the pervious and impervious cover of the remaining contributing areas.
- If any other calculation methods are utilized (e.g. TR-55), all the contributing areas and related practices must be modeled according to the requirements of the selected method.
- All green infrastructure practices must be designed for over flow and safe passage of storms greater than the design capacity of the system and conveyed to facilities designed for quantity controls.
- A drainage layer shall be incorporated in most practices to enhance structural integrity, storage, drainage, and infiltration and may not be neglected.

New York State Stormwater Management Design Manual

Chapter 5: Green Infrastructure Practices

Section 5.3 Green Infrastructure Techniques

•

Table 5.7 Green Infrastructure Techniques for Runoff Reduction

Practice	Description
Conservation of Natural Areas	Retain the pre-development hydrologic and water quality characteristics of undisturbed natural areas, stream and wetland buffers by restoring and/or permanently conserving these areas on a site.
Sheetflow to Riparian Buffers or Filter Strips	Undisturbed natural areas such as forested conservation areas and stream buffers or vegetated filter strips and riparian buffers can be used to treat and control stormwater runoff from some areas of a development project.
Vegetated Swale	The natural drainage paths, or properly designed vegetated channels, can be used instead of constructing underground storm sewers or concrete open channels to increase time of concentration, reduce the peak discharge, and provide infiltration.
Tree Planting / Tree Pit	Plant or conserve trees to reduce stormwater runoff, increase nutrient uptake, and provide bank stabilization. Trees can be used for applications such as landscaping, stormwater management practice areas, conservation areas and erosion and sediment control.
Disconnection of Rooftop Runoff	Direct runoff from residential rooftop areas and upland overland runoff flow to designated pervious areas to reduce runoff volumes and rates.
Stream Daylighting	Stream Daylight previously-culverted/piped streams to restore natural habitats, better attenuate runoff by increasing the storage size, promoting infiltration, and help reduce pollutant loads.
Rain Gardens	Manage and treat small volumes of stormwater runoff using a conditioned planting soil bed and planting materials to filter runoff stored within a shallow depression.
Green Roofs	Capture runoff by a layer of vegetation and soil installed on top of a conventional flat or sloped roof. The rooftop vegetation allows evaporation and evapotranspiration processes to reduce volume and discharge rate of runoff entering conveyance system.
Stormwater Planters	Small landscaped stormwater treatment devices that can be designed as infiltration or filtering practices. Stormwater planters use soil infiltration and biogeochemical processes to decrease stormwater quantity and improve water quality.
Rain Barrels and /Cisterns	Capture and store stormwater runoff to be used for irrigation systems or filtered and reused for non-contact activities.
Porous Pavement	Pervious types of pavements that provide an alternative to conventional paved surfaces, designed to infiltrate rainfall through the surface, thereby reducing stormwater runoff from a site and providing some pollutant uptake in the underlying soils. When designed in accordance with the design elements in section 5.3.11, the WQv for the contributing drainage area is applied towards the runoff reduction

5.3.1 Conservation of Natural Areas

The purpose of this runoff reduction method is to retain the pre-development hydrologic and water quality characteristics of undisturbed natural areas (e.g. forest areas, stream and wetland buffers) by permanently conserving these areas on a site. By using this practice, a stormwater designer would be able to subtract the area to be designated as a conservation area from total contributing drainage area when computing water quality volume requirements. An added benefit will be that the post-development peak discharges will be smaller, and hence water quantity control volumes (C_p , Q_p , and Q_f) will be reduced due to lower post-development curve numbers. It should be noted that reducing reduced curve number will result in smaller runoff rate and volume. For stream or wetland buffers, reduction may only be applied when the actual stream or wetland is located substantially within the property boundaries of the site; in other words the property owner must have sole control of the buffer.

Storms at and below the WQv precipitation frequency (i.e., the 90% event), will not generate significant stormwater runoff from pervious surfaces depending on the soil type and compaction. The design of the stream or wetland buffer treatment system must use appropriate methods for conveying flows above the annual recurrence (1-yr storm) event. No change in either area or runoff curve number (CN) would be allowed for Q_p or Q_f for this credit.

Recommended Application of Practice

- Examples of natural area conservation include:
- Forest retention areas (including reforestation areas)
- Stream and river corridors, wetlands, vernal pools and associated buffers, as well as other lands in protective easement (e.g., floodplains, undisturbed open space)

Benefits

- Reduces the runoff treatment volume and reduces SMP storage volume and size
- Saves cost and possible land consumption for SMPs
- Provides permanent protection of open space that appeals to many residents and can increase property value

New York State Stormwater Management Design Manual

Chapter 5: Green Infrastructure Practices

Section 5.3 Green Infrastructure Techniques

- Promotes protection of natural hydrologic balance that maintains pre-developed groundwater recharge characteristics

Feasibility/Limitation

- Requires delineation, permanent protection and enforcement of buffers and natural areas
- Requires establishment of a legal protective easement
- Some sites may be too steep to effectively implement natural conservation areas
- May be perceived to limit development potential
- Some residents may perceive natural areas as potential nuisance areas for vermin and pests

Sizing and Design Criteria

- Subtract conservation areas from total contributing drainage area when computing water quality volume. This practice is not applicable if the Sheetflow to Riparian Buffer, or another area based practice, is already being taken for the same area. The conservation area must be an onsite drainage area that contributes runoff to the WQv.
- Conservation area cannot be disturbed during project construction.
- These natural areas should be delineated to maximize contiguous land area and avoid fragmentation.

Required Elements

- All conservation areas:
 - Shall have a minimum contiguous area requirement of 10,000 ft²
 - Shall be protected by limits of disturbance clearly shown on all construction drawings and marked in the field/project development site with structural barriers
 - Shall be located within an acceptable conservation easement instrument that ensures perpetual protection of the proposed area. The easement must clearly specify how the natural area vegetation shall be managed and boundaries will be marked [Note: managed turf (e.g., playgrounds, regularly maintained open areas) is not an acceptable form of vegetation management]
- Conservation areas that receive runoff from other contributing areas must be designed according to Sheetflow to Riparian Buffer requirements.
- Conservation areas that drain to any design point can be subtracted from the contributing area for WQv calculation.

Design Example

New York State Stormwater Management Design Manual

Chapter 5: Green Infrastructure Practices

Section 5.3 Green Infrastructure Techniques

Figure 5.31 Schematic diagram of residential subdivision illustrating preservation of natural conservation areas. Areas with cross-hatching are removed from site area when calculating water quality volume.

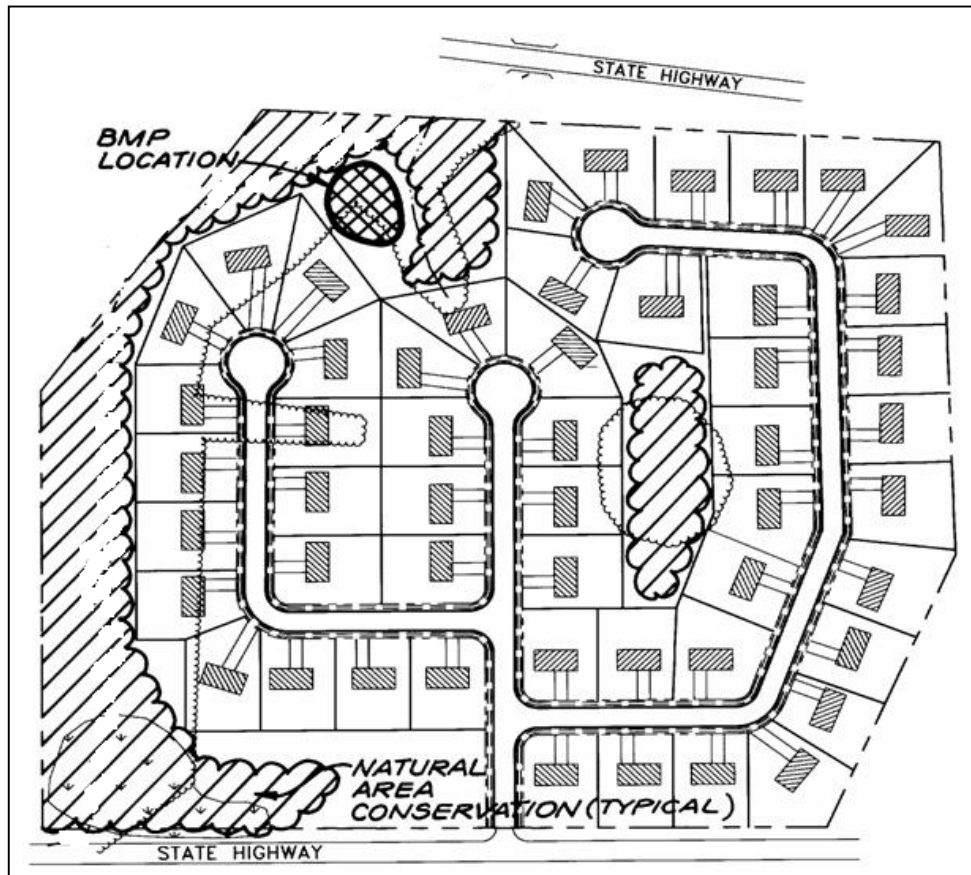

Base Data

Total contributing drainage area = 10 acres (Figure 5.32)

Proposed impervious area = 3 acres

90% Rainfall Event Number = 1.0 inch

Area to be protected as natural conservation area = 3.0 acres. In this scenario the conservation area is not receiving runoff and is subtracted from the contributing areas to a downstream SMP: $10-3=7$ acres

First, the volumetric runoff coefficient is computed:

For more information on the calculation of the volumetric runoff coefficient and other stormwater management design criteria, see Chapter 4 of this Design Manual.

Percentage of Impervious Cover: $3/7=0.43$

$$R_v = 0.05 + 0.009(43) = 0.44$$

New York State Stormwater Management Design Manual

Chapter 5: Green Infrastructure Practices

Section 5.3 Green Infrastructure Techniques

Next compute the required water quality volume:

$$WQV = (1.0 \text{ inch}) (0.44) (7 \text{ acres})/12 = 0.254 \text{ acre-feet.}$$

Under this runoff reduction practice, three acres of conservation are subtracted from total site area. Area changes from 10 to 7 acres. R_v is calculated accordingly. The reduction yields a smaller storage volume. If conservation area receives runoff from upstream areas, the Sheetflow to Riparian Buffer design and sizing requirement must be followed.

Note: It is acceptable for conservation areas to drain to proposed stormwater management treatment facilities (i.e., the SMP location in this example) and should be accounted for all other design storms.

5.3.2 Sheetflow to Riparian Buffers or Filter Strips

Description: Vegetated filter strips or undisturbed natural areas such as riparian buffers can be used to treat and control stormwater runoff from some areas of a development. Vegetated filter strips (a.k.a., grassed filter strips, filter strips, and grassed filters) are vegetated surfaces that are designed to treat sheet flow from adjacent surfaces and remove pollutants through filtration and infiltration. Riparian reforestation can be applied to existing impacted riparian area corridors.

Runoff can be directed towards riparian buffers and other undisturbed natural areas delineated in the initial stages of site planning to infiltrate runoff, reduce runoff velocity and remove pollutants. Natural depressions can be used to temporarily store (detain) and infiltrate water, particularly in areas with more permeable (hydrologic soil groups A and B) soils.

The objective in using natural areas for stormwater infiltration is to intercept runoff before it has become substantially concentrated and then distribute this flow evenly (as sheet flow) to the buffer or natural conservation area. This can typically be accomplished using a level spreader, as seen in Figure 5.33. A mechanism for the bypass of higher-flow events should be provided to reduce erosion or damage to a buffer or undisturbed natural area. Recommended buffer widths for various uses are indicated in Figure 5.34.

Carefully constructed berms can be placed around natural depressions and below undisturbed vegetated areas

Figure 5.32 Use of a level spreader with a riparian buffer

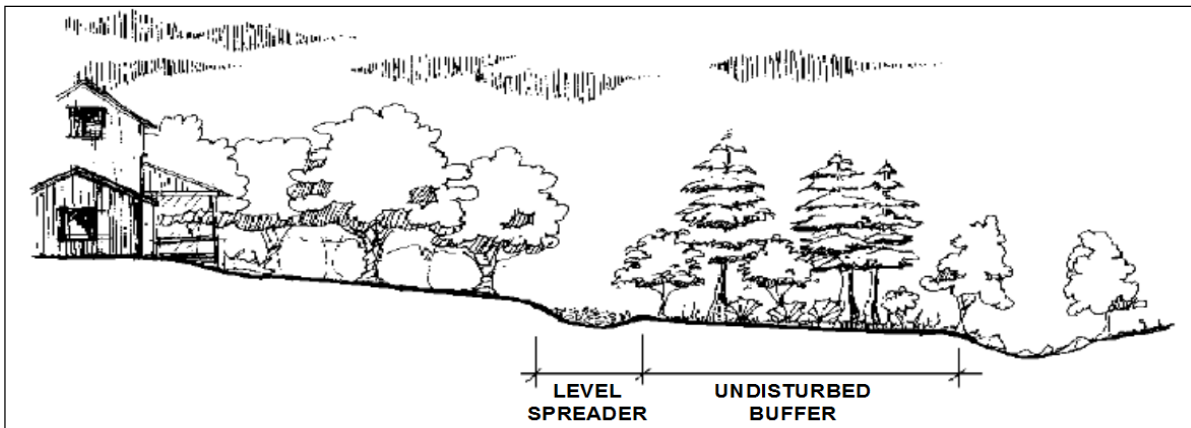

with porous soils to provide for additional runoff storage and/or infiltration of flows.

There are two design variants for sheet flow into filter strips and riparian buffers. The design, installation and management of these design variants are quite different, as shown in Table 5.8.

New York State Stormwater Management Design Manual

Chapter 5: Green Infrastructure Practices

Section 5.3 Green Infrastructure Techniques

Table 5.8 The Two Design Variations of the Filter Strip and Vegetative Buffer

Design Issue	Sheetflow to Riparian Buffer	Sheetflow to Grass Filter Strip
Soil and Ground Cover	Undisturbed Soils and Native Vegetation	Amended Soils and Dense Turf Cover
Construction Stage	Located Outside the Limits of Disturbance and Protected by ESC controls	Prevent Soil Compaction by Heavy Equipment
Typical Application	Adjacent Drainage to Stream Buffer or Forest Conservation Area	Treat small areas of impervious cover (e.g., 5,000 sf) close to source
Compost Amendments	No	Yes
Boundary Spreader	GD at top of filter	GD at top of filter PB at toe of filter
Boundary Zone	10 feet of level grass	At 25 feet of level grass
Concentrated Flow	ELS with 40 to 65 feet long level spreader* per one cfs of flow, depending on width of conservation area	ELS with length of level spreader per one cfs of flow
Maximum Slope, First Ten Feet of Filter	Less than 4%	Less than 2%
Maximum Overall Slope	6%	8%
GD: Gravel Diaphragm PB: Permeable Berm. ELS: Engineered Level Spreader, * See the NY Standards and Specifications for Erosion and Sediment Control for the design of level spreaders		

Recommended Application of Practice

- Direct runoff towards undisturbed riparian buffers or filter strips, using sheet flow or a level spreader to ensure sheet flow
- Use natural depressions for runoff storage
- Examine the slope, soils and vegetative cover of the buffer/filter strip
- Disconnect impervious areas to these areas
- Buffers may also be used as pretreatment

New York State Stormwater Management Design Manual

Chapter 5: Green Infrastructure Practices

Section 5.3 Green Infrastructure Techniques

Figure 5.33 Preservation of buffers for various environmental quality goals

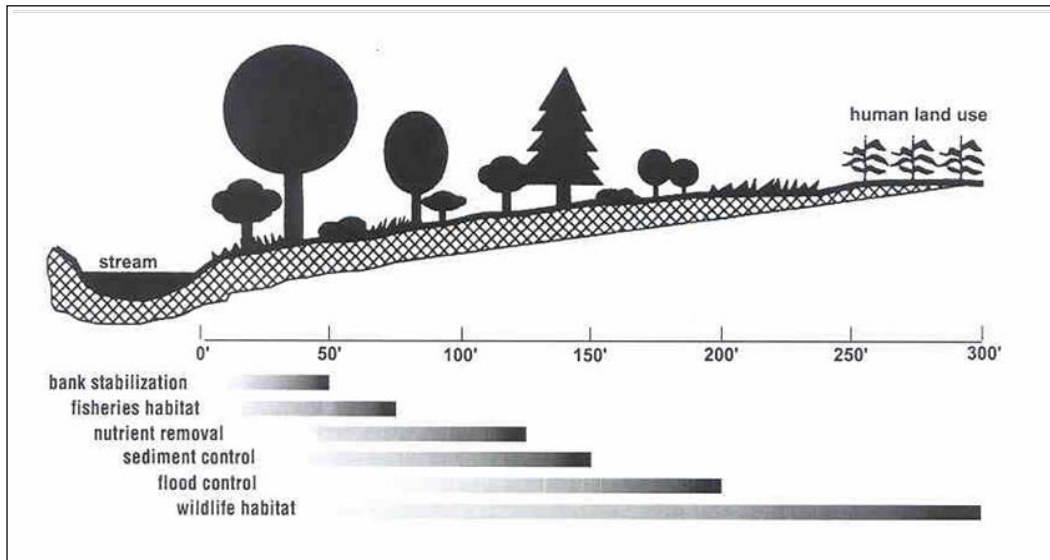

Benefits

- Riparian buffers and undisturbed vegetated areas can be used to filter and infiltrate stormwater runoff
- Natural depressions can provide inexpensive storage and detention of stormwater flows
- Can provide groundwater recharge
- Provides a valuable corridor for protection of stream or wetland and shoreline habitats
- Reduces the runoff volume that requires treatment and reduces SMP storage volume and size - See Figure 5.35
- Saves cost and possible land consumption for SMPs
- Promotes protection of natural hydrologic balance that maintains pre-developed groundwater recharge characteristics
- Reduces pollutant load delivery to receiving waters that will help meet water quality standard requirements

Feasibility /Limitations

- Require space – Use in areas where land is available and land costs are not significantly high
- Will not be available to sites without riparian areas or already forested riparian areas

Figure 5.34 Use of a vegetated filter



New York State Stormwater Management Design Manual

Chapter 5: Green Infrastructure Practices

Section 5.3 Green Infrastructure Techniques

- May be inappropriate in areas of higher pollutant loading due to direct infiltration of pollutants– Integrate with other practices to ensure adequate treatment prior to discharge
- Channelization and premature failure can occur. This can be alleviated with proper design, construction and maintenance
- Requires delineation, permanent protection of natural areas, and enforcement for buffer area protections to be effective
- Sheet flow to a buffer is difficult to maintain and enforce
- Some sites may be too steep to effectively implement these practices
- Some residents may perceive natural buffer areas as potential nuisance areas for vermin and pests
- May be difficult to maintain minimum buffer distances and contributing flow paths

Required Elements

Filter Strip and Riparian Buffers to stream and wetland:

- Maximum contributing length shall be 150 feet for pervious and 75 feet for impervious surfaces
- Runoff shall enter the buffer as overland sheet flow; a flow spreader can be supplied to ensure this, if average contributing slope criteria cannot be met (Note: a level spreader shall be used between buffer slopes ranging between 3% and 15%; for buffer slopes beyond 15% this practice cannot be applied)
- Minimum width of a vegetated filter strip or undisturbed riparian buffer shall be 50 feet for slopes of 0% to 8%, 75 feet for slopes of 8% to 12% and 100 feet for slopes of 12 % to 15 %.
- Buffers must be fully vegetated.
- Siting and sizing of this practice should address WQv and runoff reduction requirements and cannot result in overflow to undesignated areas.

Note: The NYS Freshwater Wetlands Act requires a 100-foot buffer for wetlands greater than 12.4 acres. Applicants required to meet other regulatory requirements are still eligible to meet the stream and wetland buffer credit provided the criteria cited above are also met.

Sizing and Design Criteria:

Subtract area draining by sheet flow to a riparian buffer or filter strip when computing the water quality volume. See Figure 5.36. If the area draining contains impervious surface, the R_v value is reduced as well. This practice is not applicable if the Disconnection of Rooftop Runoff or another area based practice is already being applied to this area.

New York State Stormwater Management Design Manual

Chapter 5: Green Infrastructure Practices

Section 5.3 Green Infrastructure Techniques

Figure 5.35 Illustration of stream buffer practice. Site areas draining to stream buffer that meet the specified criteria are removed from site area when calculating storage volumes for water quality.

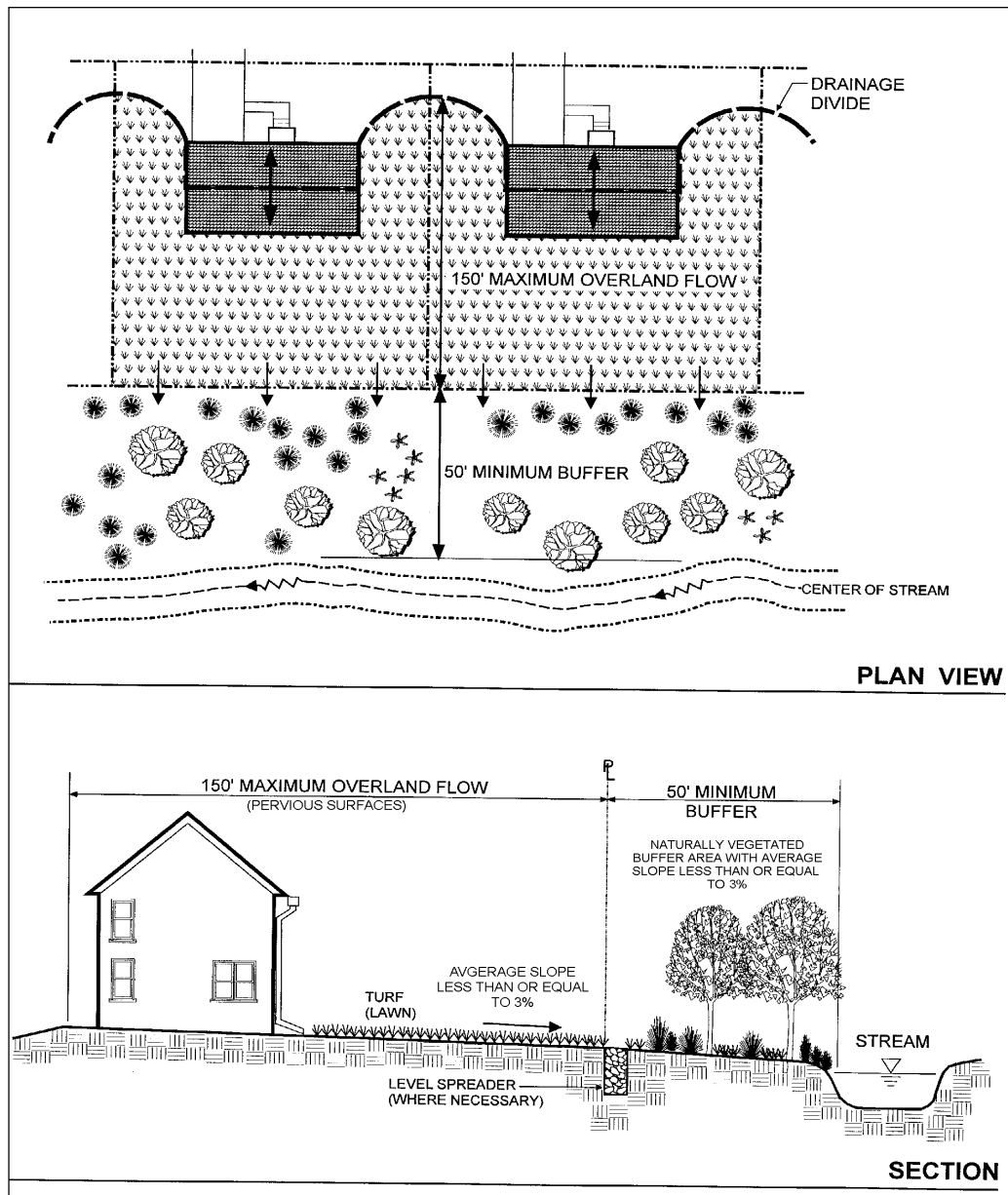

- Maximum contributing length shall be 150 feet for pervious surfaces and 75 feet for impervious cover
- In HSG C and D buffer length should be increased by 15%-20% respectively.
- For a combination of impervious cover (IC) and pervious cover (PC), use the following to determine the maximum length of each contributing area:
- $150 - IC =$ contributing length of PC (maximum IC = 75, maximum PC =150).

New York State Stormwater Management Design Manual

Chapter 5: Green Infrastructure Practices

Section 5.3 Green Infrastructure Techniques

- Example: $(75-IC)*2+IC$ = total of contributing length.
- The average contributing slope shall be 3% maximum unless a flow spreader is used
- Runoff shall enter the riparian corridor as overland sheet flow. A flow spreader can be supplied to ensure this, or if average contributing slope criteria cannot be met
- Not applicable if overland flow filtration/groundwater recharge is already credited for the same impervious cover
- Newly created riparian reforestation areas shall be maintained as a natural area

References/Further Resources

Center for Watershed Protection. 1998. *Better Site Design: A Handbook for Changing Development Rules in Your Community*. Available from www.cwp.org

City of Portland, Oregon. September 2004. *Stormwater Management Manual*. Bureau of Environmental Services, Portland, OR. Available from <http://www.portlandonline.com/bes/>

Prince George's County, MD. June 1999. *Low-Impact Development Design Strategies: An Integrated Design Approach*. Prince George's County, Maryland, Department of Environmental Resources, Largo, Maryland. Available from www.epa.gov

Virginia Department of Conservation and Recreation (VA DCR), Virginia DCR Stormwater Design Specification No.2, "Sheet Flow To A Filter Strip or Conserved Open Space", Version 1.6, Dated September 30, 2009.

5.3.3 Vegetated Swale

A vegetated swale is a maintained, turf-lined swale specifically designed to convey stormwater at a low velocity, promoting natural treatment and infiltration. A properly designed, constructed, and maintained channel (or, in some cases natural drainage path) can be used in both residential and non-residential areas as a runoff reduction practice. A vegetated swale can be an alternative to underground storm sewers or lined open channels. Where drainage area, topography, soils, slope and safety issues permit, vegetated swales can be used in the street right-of-way and on developed sites to convey and treat stormwater from roadways and other impervious surfaces.

When compared to underground pipes or hardened channels, vegetated swales increase the time-of-concentration (T_c), reduce the peak discharge and provide infiltration opportunities. A vegetated swale designed in accordance with the criteria in this section will provide modest (10-20%) runoff reduction for the water quality volume (WQv) for certain development conditions.

The vegetation height in a vegetated swale should be maintained at approximately 4 inches to 6 inches.

Note: Other types of swales are used for simple conveyance, diversion, conventional water quality treatment (wet and dry swales, Chapter 6) and pretreatment. Unique design and application criteria (different from vegetated swale) must be applied for each specific type of use.

Benefits

- Reduces the cost of road and stormwater conveyance construction
- Provides some runoff storage and infiltration, as well as treatment of stormwater
- If a vegetated swale is properly designed, a 10-20% reduction of WQv may be applied for sizing conventional treatment practices within the contributing DA
- The post-development peak discharges used to calculate “quantity” controls will likely be lower, due to a slightly longer T_c for the site
- Reduced maintenance costs

Feasibility/Limitations

- Local codes may not allow swales instead of curb and gutter or closed drainage pipes – *Meet with local officials to discuss waivers for alternative designs*

New York State Stormwater Management Design Manual

Chapter 5: Green Infrastructure Practices

Section 5.3 Green Infrastructure Techniques

- There is a perception that swales require more maintenance than curb and gutter or closed drainage pipes – *With the proper design and proper education of owners, swales require less maintenance and are less prone to failure*
- Lack of curbing may increase potential for failure of the pavement at the grass interface – *The potential for failure can be alleviated by hardening the interface by installing grass pavers, geosynthetics, or placing a compacted granular material strip along the pavement edge*
- Swales in residential neighborhoods are perceived to reduce property values and the “curb appeal” for re-sale, when compared to conventional curb and gutter street systems. – *Properly designed and maintained vegetated swale can be incorporated into landscaped lawn areas, with no impact to property value or neighborhood character*

Sizing Criteria

A vegetated swale can be used where the contributing DA is less than 5 acres, and when the WQv peak flow (Q_{WQV}) is less than 3cfs.

The WQv for a vegetated swale is computed in accordance with the uniform sizing criteria methods outlined in Chapter 4. Design flows are calculated using small storm hydrology (APPENDIX B), and conventional hydrology methods (Chapter 8) in conjunction with Manning’s equation for open channel flow.

For a properly designed vegetated swale, the following runoff reductions in the computed WQv may be applied to the water quality volume of the drainage area for which the swale is designed:

Hydrologic Group A and B soils – 20%

Hydrologic Group C and D soils – 10%

Modified* Hydrologic Group C and D soil – 15%-12%

**Modifications must be in accordance with Soil Restoration in Chapter 5 of this Manual.*

Required Elements

The vegetated swale design must:

- Receive peak water quality volume flow rates from the contributing drainage area that are no greater than 3 cfs
- Provide sufficient length (minimum 100 ft) to retain the computed treatment volume for 10 minutes in a swale that receives runoff as a point discharge at the inlet, or an average of 5 minutes of retention time for a swale receiving sheet drainage or multiple point discharges along its length

New York State Stormwater Management Design Manual

Chapter 5: Green Infrastructure Practices

Section 5.3 Green Infrastructure Techniques

- Convey the peak discharge for water volume flow (3 cfs or less):
 - a. at a velocity of ≤ 1.0 fps, and
 - b. at a flow depth of 4 inches or less
- Check Dam may be required to achieve the above criteria
- Have a trapezoidal or parabolic shape, with a bottom width minimum of 2' and no greater than 6'
- Have side slopes no steeper than 3 horizontal:1 vertical
- Have a slope between 0.5% and 4% (between 1.5- 2.5 percent recommended)
- Convey the 10-year storm with 6 inches of freeboard at a velocity ≤ 5 fps
- Use variable n values corresponding to flow depths (from .15 down to .03) (APPENDIX L)

Design Example

Design a vegetated swale to provide water quality runoff reduction treatment for a 4-acre section of a 30-acre residential development with eight ½-acre lots (25% impervious surfaces) on Hydrologic Soil Group B soils. This developed area will drain to a 625-foot long flow path on a natural gradient of 3.5%.

The following data has already been computed for the 4 acres:

$$WQ_v = 3,500 \text{ feet}^3 \text{ (90\% rule, Chapter 4)}$$

$$Q_{WQV} = 2.5 \text{ cfs (small storm hydrology, APPENDIX B)}$$

$$Q_{10} = 8.0 \text{ cfs (TR-55, Chapter 8)}$$

Try the following swale design:

A 2-foot deep trapezoidal channel with a bottom width of 4', with 1:3 side slopes, and a design slope of 3%.

Determine the Q_{WQV} flow depth and velocity (using Manning's equation iterations, computer programs or selected design charts):

$$Q = 1.49 / n \cdot A \cdot ((A/P)^{2/3}) \cdot S^{1/2}$$

$$\text{Area (for trapezoid)} = (\text{bottom width} + \text{top width})/2 \times \text{depth}$$

$$P \text{ (for trapezoid)} = \text{bottom width} + (\text{wetted side slope surface} \times 2)$$

$$S = \text{slope (ft/ft)}$$

$$n = \text{Manning's number}$$

New York State Stormwater Management Design Manual

Chapter 5: Green Infrastructure Practices

Section 5.3 Green Infrastructure Techniques

For a flow depth of 6”:

$$n = 0.12 \text{ (APPENDIX L, FIGURE L.1)}$$

$$S = 0.03 \text{ ft/ft}$$

$$A = [4' + (0.5' \times 3 \times 2) + 4'] / 2 \times 0.5$$

$$A = 2.75 \text{ ft}^2$$

$$P = 4 + [(0.5)^2 + (0.5 \times 3)^2]^{1/2} \times 2$$

$$P = 7.16 \text{ ft}$$

$$\text{Mannings: } Q = 1.49 / 0.12 \times 2.75 \times (2.75 / 7.16)^{2/3} \times (0.03)^{1/2}$$

$$Q = 3.1 \text{ cfs}$$

For $Q = 3.1$ cfs and flow depth of 6” (0.5’), velocity is 1.1 fps.

These conditions exceed the velocity limit.

Try a flatter 2.5% slope to reduce velocity and flow depth (using Manning’s equation iterations, computer programs or selected design charts):

For $Q = 2.5$ cfs, flow depth is 5.8” (0.48’) ($n = .125$), and velocity is 0.9 fps.

This swale design meets the depth and velocity criteria.

Determine the WQv flow retention time (at least 10 minutes) for the 625-foot long channel:

Flow length/velocity = detention time

$$625' / 0.9 \text{ fps} = 694 \text{ seconds} / 60 \text{ seconds} = 11.6 \text{ minutes}$$

The vegetated swale length provides sufficient retention of the WQv flow.

Determine the flow depth and velocity for Q_{10} (using Manning’s equation iterations, computer programs or selected design charts):

For $Q = 8.0$ cfs, flow depth = 8.5” (0.71’) ($n = .08$), and velocity is 1.8 fps ($is < 5$ fps).

The swale design meets the criteria for conveying a 10-year peak flow.

With a Q_{10} flow depth of 0.75’ and .5’ of freeboard, the design depth can be reduced from 2’ to 1.5’.

A 625-foot long, 1.5 foot deep trapezoidal channel with 1:3 side slopes and a 4-foot bottom width on a 2.5% slope on B soils will provide a 20% reduction in the water quality volume design requirement for the 8-lot section of development. New WQv = 3500 - 20% = 2800 feet³

Vegetative Requirements

- Strip vegetation, soil and debris from swale by hand where possible
- Amend soil as needed with fertilizer and lime

New York State Stormwater Management Design Manual

Chapter 5: Green Infrastructure Practices

Section 5.3 Green Infrastructure Techniques

- Provide 4 inches of topsoil
- Remove all stones and debris that may hinder flow and maintenance
- Apply recommended seed mixes (or sod) per Table 5.9

Table 5.9		
Mixtures	Rate per Acre (pounds)	Rate per 1,000 square feet (pounds)
A. Perennial ryegrass	30	0.68
Tall fescue or smooth bromegrass	20	0.45
Redtop	2	0.05
OR		
B. Kentucky bluegrass ¹	25	0.60
Creeping red fescue	20	0.50
Perennial ryegrass	10	0.20

¹ Use this mixture in areas which are mowed frequently. Common white clover may be added if desired and seeded at 8 pounds/acre (0.2 pound/1,000 square feet).

- Roll or culti-pack seeds and mulch seed bed. Anchor mulching as needed.
- Water as needed

Maintenance Requirements

- Fertilize and lime as needed to maintain dense vegetation.
- Mow as required during the growing season to maintain grass heights at 4 inches to 6 inches.
- Remove any sediment or debris buildup by hand if possible in the bottom of the channel when the depth reaches 2 inches.
- Inspect for pools of standing water. Regrade to restore design grade and revegetate.
- Repair rills in channel bottom with compacted topsoil, anchored with mesh or filter fabric. Seed and mulch.
- Use of heavy equipment for mowing and removing plants/debris should be avoided to minimize soil compaction. Disturbed areas should be stabilized with seed and mulch, or revetment, as necessary.

New York State Stormwater Management Design Manual

Chapter 5: Green Infrastructure Practices

Section 5.3 Green Infrastructure Techniques

References/Further Resources

Center for Watershed Protection, 1996. *Design of Filtering Systems*. Available from www.cwp.org.

Center for Watershed Protection. 1998. *Better Site Design: A Handbook for Changing Development Rules in Your Community*. Available from www.cwp.org.

Center for Watershed Protection. August 2003. *New York State Stormwater Management Design Manual*. Prepared for New York State Department of Environmental Conservation, Albany, New York. <http://www.dec.state.ny.us/website/dow/toolbox/swmanual/#Downloads>.

City of Portland, Oregon. September 2004. *Stormwater Management Manual*. Bureau of Environmental Services, Portland, Oregon. Available from <http://www.portlandonline.com/bes/>.

[CSN](#) Technical Bulletin No. 4 Technical Support for the Bay-Wide Runoff Reduction Method Version 2.0. Available at www.chesapeakestormwater.net.

New York State Standards and Specifications for Erosion & Sediment Control. August 2005. Available from <http://www.dec.state.ny.us>.

Pennsylvania Stormwater Best Management Practices Manual. December 30, 2006. Available from [www.depweb.state.pa.us/watershed mgmt](http://www.depweb.state.pa.us/watershed_mgmt).

Prince George's County, MD. June 1999. *Low-Impact Development Design Strategies: An Integrated Design Approach*. Prince George's County, Maryland, Department of Environmental Resources, Largo, Maryland. Available from www.epa.gov.

5.3.4 Tree Planting/Tree Pit

Description:

Conserving existing trees or planting new trees at new or redevelopment sites can reduce stormwater runoff, promote evapotranspiration, increase nutrient uptake, provide shading and thermal reductions, and encourage wildlife habitat. The technique is similar to riparian restoration but is generally conducted on a smaller scale. It is uniquely suited to new and redevelopment in urban and suburban areas.

Tree planting generally refers to concentrated groupings of trees planted in landscaped areas while tree pits, also called tree boxes, generally refer to individually planted trees in contained areas such as sidewalk cut-outs or curbed islands.

Tree planting can be used for applications such as landscaping, stormwater management practice areas, conservation areas and erosion and sediment control. However, stormwater management practices listed in Chapter 6 and areas designated for other runoff reduction techniques cannot also be considered as runoff reduction areas for this technique.

Recommended Application of the Practice

- Conservation of existing trees is recommended where stands of existing trees are non-invasive, healthy and likely to continue to flourish in the proposed site conditions.
- Planting of new trees is recommended for areas that will remain or become pervious in the proposed condition and are large enough to sustain multiple trees.
- Planting of trees in tree pits is recommended in street rights-of-way or other small-scale pervious areas in highly impervious redevelopment sites that can support limited tree development. See Figure 5.37.

**Figure 5.36 Mature trees conserved during development
(Photo Sources: Randall Arendt and Ed Gilman)**



Benefits

- Tree planting can reduce stormwater volumes and velocities discharging from impervious areas through rainfall interception and evapotranspiration (ET).
- Planting trees can increase nutrient uptake, reduce runoff, aid infiltration, provide wildlife

New York State Stormwater Management Design Manual

Chapter 5: Green Infrastructure Practices

Section 5.3 Green Infrastructure Techniques

habitat, provide shading, discourage geese and reduce mowing costs.

- Trees contribute to the processes of air purification and oxygen regeneration.
- Mature trees can reduce urban heat island, decrease heating and cooling costs, block UV radiation.
- Mature trees buffer wind and noise.
- Tree planting can increase property values.

Feasibility/Limitations

- While tree planting can enhance stormwater management goals, it is not a “stand alone” treatment or management practice.
- Local codes may restrict trees in certain areas. Consult with local officials to discuss waivers for alternative designs.
- Overhead and underground utilities may limit the types of trees that can be planted and their location.
- Trees may not survive through construction or in certain urban environments unless proper tree selection, landscape design, protection and maintenance are incorporated in the technique. Inadequate soil rooting volumes and compacted soils are the largest factors in tree decline, and can lead to cracked and lifted pavements, curbs and retaining walls.
- Native vegetation may be perceived to harbor undesirable wildlife and insects. However, most people enjoy viewing wildlife, and native vegetation does not provide a food source for most vermin. Continued education is necessary to show that humans and wildlife can co-exist, even at the neighborhood level.

Sizing and Design Criteria

- For tree planting, runoff reduction may be determined using the same method as Riparian Buffer practice (Section 5.3.2). The area considered for runoff reduction is limited to the pervious area in which trees are planted. In an urban setting where trees are contained by impervious structures such as curbs and sidewalks, the area is calculated as follows: For up to a 16-foot diameter canopy of a mature tree, the area considered for reduction shall be ½ the area of the tree canopy. For larger trees, the area credited is 100 SF per tree. This can be considered the drainage area into the below grade tree pit.
- An alternative sizing for runoff reduction in urban setting may follow the bioretention or stormwater planters (with infiltration) design and sizing. In this case sizing of the practice relies on storage capacity of the soil voids in the cavity created for the root ball of the tree and the ponding area. The infiltration rate of the in-situ soil must be a minimum of 2 inches per hour.

Required Elements

New York State Stormwater Management Design Manual

Chapter 5: Green Infrastructure Practices

Section 5.3 Green Infrastructure Techniques

Conservation of existing native trees during the development process should be managed in a systematic manner using the following steps:

1. Inventory existing trees on-site.
2. Identify trees to be protected.
3. Design the development with conservation of these trees in mind.
4. Protect the trees and surrounding soils during construction by limiting clearing, grading and compaction.
5. Protect and maintain trees post construction.

Where conservation of existing trees is utilized:

- A directly connected impervious area reduction equal to one-half the canopy area is permitted and is only applied to the area adjacent to the tree.
- The tree species must be chosen from the approved list (see Landscape Guidance of this Manual or a consult local list of native species).
- Existing trees whose canopies are within 20 horizontal feet of directly connected ground level impervious areas can be used for runoff reduction.
- Existing trees must be at least 4-inch caliper to be eligible for the reduction.
- Applicable to trees within the subject drainage area

For planting of new trees, maximize the use of pervious areas on the site that are good locations for tree planting. For example: road rights-of-way, landscaped islands in cul-de-sacs or traffic circles, parking lots, and private lawns. These urban planting sites may have harsh soil and environmental conditions that must be addressed through appropriate species selection or proper site preparation prior to planting.

Where new trees are planted:

- The tree species must be chosen from the approved list (see Landscape Guidance of this Manual or a consult local list of native species).
- New trees planted must be planted within 10 feet of ground-level, directly connected impervious areas.
- New deciduous trees must be at least 2-inch caliper and new evergreen trees must be at least 6 feet tall to be eligible for the reduction.
- A 100 square-foot directly connected impervious area reduction is permitted for each new tree. This credit may only be applied to the impervious area adjacent to the tree.

New York State Stormwater Management Design Manual

Chapter 5: Green Infrastructure Practices

Section 5.3 Green Infrastructure Techniques

- Recommend minimum 1,000 cubic feet soil media available per tree.

For new trees, the average slope for the contributing area, including the area under the canopy must not be greater than 5%. The maximum slope can be increased where existing trees are being preserved. Slope specifications for filter strips and buffers should be followed as guidelines. The maximum reduction permitted, for both new and existing trees, is 25% of directly connected ground level impervious area.

Example

One example of tree planting is where single tree planting within impervious area is utilized. For such scenarios the stormwater planter example, as a storage or flow through system, should be used.

Another example is where a group of trees within a reasonably large pervious area is planted. In such scenarios, planting area can be used for impervious cover disconnection. Follow Rooftop Disconnection or Sheet Flow to Filter Strip example. If the tree planting area is connected to an SMP and discharges to a design point, the area reduction example for natural area conservation can be followed.

Environmental/Landscaping Elements

- Adequate space must be provided for each tree to grow.
- Trees should be selected for diversity and to promote native, non-invasive species.
- Soil quality and volume may be poor. Soil amendments and decompaction may be required prior to planting. Heavy equipment traffic should be limited in the vicinity of both existing and proposed tree planting areas.
- **Maintenance**
 - During the first three years, mulching, watering and protection of young trees may be necessary and should be included in the inspection list.
 - Inspections should be performed every three months and within one week of ice storms, within one week of high wind events that reach speeds of 20 mph until trees have reached maturity, and according to established tree inspection requirements as identified within this document.
 - As a minimum, the following items should be included in the regular inspection list:
 - Assess tree health
 - Determine survival rate; replace any dead trees.
 - 1) Inspect tree for evidence of insect and disease damage; treat as necessary
 - 2) Inspect tree for damages or dead limbs; prune as necessary

New York State Stormwater Management Design Manual

Chapter 5: Green Infrastructure Practices

Section 5.3 Green Infrastructure Techniques

References/Further Resources

American Forests website: www.americanforests.org

American National Standards Institute. 2004. ANSI Z60.1-2004. American Standards for Nursery Stock. 112 p.

Cappiella, K., T. Schueler, T. Wright. 2004. Urban Watershed Forestry Manual. Available from www.cwp.org

City of Toronto Tree Advocacy Planting Program website:
<http://www.city.toronto.on.ca/parks/treadvocacy.htm>

CSN Technical Bulletin No. 4, Technical Support for the Baywide Runoff Reduction Method, Version 2.0
<http://www.chesapeakestormwater.net/all-things-stormwater/technical-support-for-the-baywide-runoff-reduction-method.html>

International Society of Arboriculture website: <http://www.isa-arbor.com/publications>.

Stormwater Management Guidance Manual City of Philadelphia Version 2.0, Philadelphia Water Department Office of Watersheds,
<http://www.phillyriverinfo.org/WICLibrary/PSMGM%20V2.0.pdf>, last visited 10/28/09.

NYC Department of Design & Construction Office of Sustainable Design
http://www.nyc.gov/html/ddc/downloads/pdf/ddc_sd-sitedesignmanual.pdf

5.3.5 Disconnection of Rooftop Runoff

Direct runoff from residential rooftop areas to designated pervious areas to reduce runoff volumes and rates. This practice may only be applied when “filtration/infiltration areas” are incorporated into the site design to receive runoff from rooftops. This can be achieved by grading the site to promote overland vegetative filtering or by providing infiltration areas (figure 5.38). If impervious areas are adequately disconnected, they can be treated as pervious area when computing the water quality volume requirements (resulting in a smaller R_v). Impervious areas are not deducted when calculating controls for larger storms but post-development peak discharges used to calculate “quantity” controls will likely be lower due to a longer time of concentration for the site.

Benefits

- Sending runoff to pervious areas and lower-impact practices increases overland flow time and reduces peak flows.
- Vegetated and pervious areas can filter and infiltrate runoff, thus increasing water quality.

Feasibility/Limitations

- Wet basements will result from re-directing rooftop runoff – *careful design and construction inspection will minimize this condition;*
- Re-directed rooftop runoff may increase a property owner’s maintenance burden;
- Alternative rooftop runoff mitigation may be costly – *Rain barrels in fact are inexpensive and will reduce water use costs; green roofs reduce heating and cooling costs and roof replacement costs.*
- Local law may prohibit or limit rooftop disconnection.

Figure 5.37 Disconnection of rooftop to designated vegetated areas. Otter Creek, NY, NYSDEC.



Sizing and Design Criteria

If impervious areas are adequately disconnected, they can be deducted from the site’s impervious total (R_v calculation) when computing WQ_v . Stormwater quantity and quality benefits can be achieved by routing runoff from rooftop areas to pervious areas such as lawns, landscaping, and depressed areas designated for infiltration. As with undisturbed buffers and natural areas, designated, revegetated areas such as lawns can act as biofilters for stormwater runoff and provide for infiltration in more permeable soils (hydrologic groups

New York State Stormwater Management Design Manual

Chapter 5: Green Infrastructure Practices

Section 5.3 Green Infrastructure Techniques

A and B). Areas designated to receive runoff from rooftop disconnection must be properly graded for infiltration and conveyance in a non-erosive manner within the site boundary.

Required Elements

- Runoff from disconnected rooftop must be directed to a designated area that is appropriately graded for storage and infiltration of the runoff, re-vegetated and protected from other uses, and designed for conveyance in a non-erosive manner within the site boundary (Figure 5.39). Use splash pads or level spreaders (See the NY Standards and Specifications for Erosion and Sediment Control for the design of level spreaders) as required to distribute runoff to designated areas with infiltration capacity
- Disconnections are encouraged on permeable soils (HSGs A and B);
- In less permeable soils (HSGs C and D), permeability as well as water table depth and shall be evaluated by a certified/licensed professional to determine if a soil enhancement and spreading device is needed to provide sheet flow over grass surfaces. In some cases, soil restoration by deep tilling, de-compaction, compost amendment are needed to compensate for a poor infiltration capability;
- Runoff shall not come from a designated hotspot as listed in Section 4.11 of this Manual;
- The maximum contributing flow path length from impervious areas shall be 75 feet;
- Downspouts shall be at least 10 feet away from the nearest impervious surface to discourage “re-connections”;
- The contributing area of rooftop to each disconnected discharge shall be 500 square feet or less; larger roof areas up to 2,000 square feet may be acceptable with a suitable flow dispersion technique such as a level spreader;
- The disconnected, contributing impervious area shall drain through a vegetated channel, swale, or filter strip (filtration/infiltration areas) for a distance equal to or greater than the disconnected, contributing impervious area length;
- The entire vegetative filtration/infiltration area shall have an average slope of less than five (5) percent;
- Siting and sizing of this practice should address WQv and runoff reduction requirements and cannot not result in overflow to undesigantated areas.

Figure 5.38 Rooftop disconnection for storage and infiltration, Guilderland, NY, NYSDEC



New York State Stormwater Management Design Manual

Chapter 5: Green Infrastructure Practices

Section 5.3 Green Infrastructure Techniques

- For those areas draining directly to a buffer, either the Disconnection of Rooftop Runoff or Sheetflow to Riparian Buffer runoff reduction method can be used, but not both;
- Use splash pads or level spreaders as required to distribute runoff to designated areas with infiltration capacity.

Example Calculation

Base Data

Site Data: 108 Single Family Residential Lots (~ ½ acre lots, Figure 5.40)

Assume site is in Saratoga Springs, NY, where 90% rainfall = 1.0 inch.

Site Area = 45.1 ac

Original Impervious Area = 12.0 ac; or $I = 12.0/45.1 = 26.6\%$

Original $R_v = 0.05 + 0.009(26.6) = 0.29$

Original $WQ_v = (1.0 \text{ inch}) (0.29) (45.1 \text{ acres})/12 = 1.09 \text{ acre-feet}$

Disconnection of Rooftop Runoff (see Figure 5.39)

42 houses disconnected to a designated, permanent, vegetated easement

Average house area = 2,000 ft²

Net impervious area reduction = $(42)(2,000 \text{ ft}^2) / (43,560 \text{ ft}^2/\text{ac}) = 1.93 \text{ acres}$

New impervious area = $12.0 - 1.93 = 10.1 \text{ acres}$; or $I = 10.1/45.1 = 22.4\%$

New $R_v = 0.05 + .009(22.4) = 0.25$

New $WQ_v = (P)(R_v)(A)/12 = (1.0 \text{ in})(0.25)(45.1)/12 = 0.95 \text{ acre-feet}$

Percent Reduction Using Disconnection of Rooftop Runoff:

$WQ_v = (1.09 - 0.95) / 1.09 = 13.3\%$

New York State Stormwater Management Design Manual

Chapter 5: Green Infrastructure Practices

Section 5.3 Green Infrastructure Techniques

Figure 5.39 Schematic of rooftop disconnection to Filtration/Infiltration Zones. Impervious rooftop areas are treated as pervious for the calculation of water quality volume.

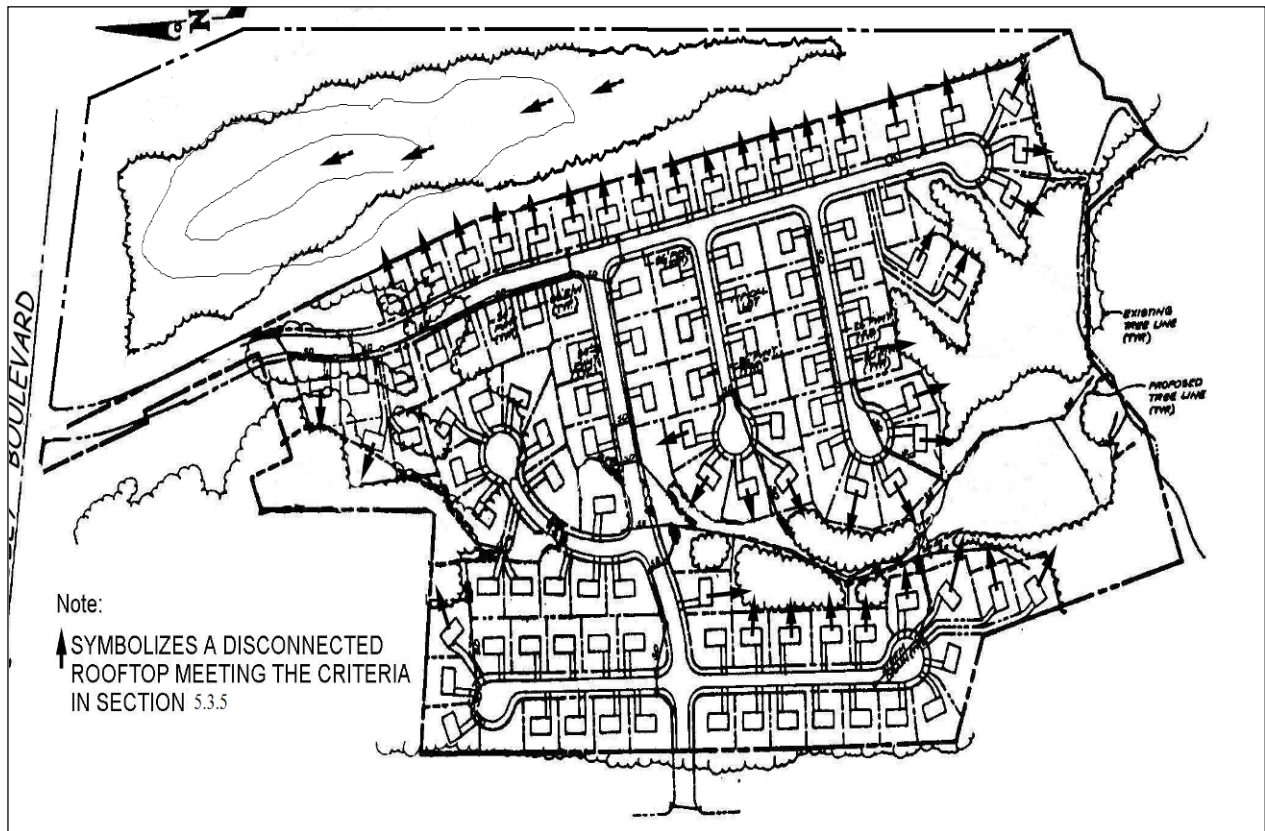

References/Further Resources

Virginia DCR Stormwater Design Specification No. 1, Rooftop (Impervious Surface) Disconnection, Version 1.7, 2010

<http://www.chesapeakestormwater.net/all-things-stormwater/rooftop-disconnection-design-specification.html>

Maryland Stormwater Design Manual, Volumes I & II, Chapter 5(Effective October 2000)

http://www.mde.state.md.us/programs/waterprograms/sedimentandstormwater/stormwater_design/index.as

p

5.3.6 Stream Daylighting

Description: Stream Daylight previously-culverted/piped streams to restore natural habitats, better attenuate runoff by increasing the storage size, promoting infiltration, and help reduce pollutant loads where feasible and practical. Stream daylighting may be credited as an Impervious Area Reduction practice for redevelopment projects in accordance with Chapter 9.

Stream daylighting involves uncovering a stream or a section of a stream that had been artificially enclosed in the past to accommodate development. The original enclosure of rivers and streams often took place in urbanized areas through the use of large culvert operations that often integrated the storm sewer system and combined sanitary sewers. The daylighting operation, therefore, often requires overhauls or updating of storm-drain systems and re-establishing stream banks where culverts once existed. When the operation is complete, what was once a linear pipe of heavily polluted water can become a meandering stream with dramatic improvements to both aesthetics and water quality.

Applications

- Consider daylighting when a culvert replacement is scheduled
- Restore historic drainage patterns by removing closed drainage systems and constructing stabilized, vegetated streams, see Figure 5.41
- Carefully examine flooding potential, utility impacts and/or prior contaminated sites
- Consider runoff pretreatment and erosion potential of restored streams/rivers

Benefits

- Improves water quality
- Prevents flooding by increasing storage and reducing peak flows
- Increases habitat and wildlife value
- Increases pedestrian traffic and general public use
- Increases property values
- Aesthetic appeal of daylighted streams can be expected to add appeal to neighborhoods or urban areas

Limitations

New York State Stormwater Management Design Manual

Chapter 5: Green Infrastructure Practices

Section 5.3 Green Infrastructure Techniques

- Daylighting a stream can be expensive - *Costs for daylighting streams are often comparable to costs for replacing culverts*
- Maintenance of daylighted stream areas can be intensive during the first years the stream is established – *Once the banks are well established, regular maintenance is similar to that required in any public green space such as trash removal, mowing and general housekeeping*
- Finding the original stream channel may be difficult – *examine historic records, soils, and up and downstream channel characteristics.*
- Political backing and public support is more difficult for daylighting streams than for surface restoration because the culvert is not seen – *Provide proper public education and outreach about the benefits and how safety issues will be addressed.*

Figure 5.40 Before and after daylighting Blackberry Creek in Berkeley, CA (Source: Stormwater Magazine, Nov/Dec 2001)



Sizing and Design Criteria

Stream daylighting is applicable only to redevelopment projects as an impervious area reduction type practice in accordance with Chapter 9. The sizing of the stream channel must, at minimum, equal or exceed the existing drainage capacity of the piped drainage system.

The impervious area reduction credited under Chapter 9 would be equal to the area of imperviousness removed for streams buried and piped under impervious areas. For streams buried and piped under pervious areas, the impervious area reduction credited would be equal to the planar area of the bed and banks of the daylighted stream.

New York State Stormwater Management Design Manual

Chapter 5: Green Infrastructure Practices

Section 5.3 Green Infrastructure Techniques

Where combined sewer overflow (CSO) separation and other upgrades to storm-sewer systems are part of a daylighting project, significant water-quality improvements can be expected during wet-weather events. Also, as ultraviolet radiation is one of the most effective ways to eliminate pathogens in water, exposing these streams to sunlight could significantly decrease pathogen counts in the surface water.

Stream daylighting can play an integral role in neighborhood restoration and site redevelopment efforts. Aside from improvements to infrastructure, stream daylighting can restore floodplain and aquatic habitat areas, reduce runoff velocities and be integrated into pedestrian walkway or bike- path design.

Stream daylighting can generally be applied most successfully to sites with considerable open or otherwise vacant space. This space is required to: 1) Potentially reposition the stream in its natural stream bed; 2) Accommodate the meandering that will be required if a natural channel is being designed and 3) Provide adjacent floodplain area to store water in large storm-flow situations.

References/Further Resources

Blankinship, Donna Gordon. Jan/Feb 2005. *Creeks are Coming Back into the Light*. Article from Stormwater Magazine Vol. 6, No. 1. Forester Communications. Caledonia, MI. Available from www.stormh2o.com

Pinkham, Richard. Nov/Dec 2001. *Daylighting: New Life for Buried Streams*. Article from Stormwater Magazine Vol. 2, No. 6. Forester Communications. Caledonia, MI. Available from www.stormh2o.com

Rhode Island Department of Environmental Management. January 2005. *The Urban Environmental Design Manual*. Rhode Island Department of Environmental Management, Providence, Rhode Island. Available from <http://www.dem.state.ri.us/programs/bpoladm/suswshed/pubs.htm>

5.3.7 Rain Gardens

Description: The rain garden is a stormwater management practice intended to manage and treat small volumes of stormwater runoff from impervious surfaces using a conditioned planting soil bed and planting materials to filter runoff stored within a shallow depression. This practice is most commonly used in residential land use settings. The method is a variation on bioretention and combines physical filtering and adsorption with bio-geochemical processes to remove pollutants. Rain gardens are a simplified version of bioretention and are designed as a passive filter system without an underdrain connected to the storm drain system. A gravel drainage layer is typically used for dispersed infiltration. Rainwater is directed into the garden from residential roof drains, driveways and other hard surfaces. The runoff temporarily ponds in the garden and seeps into the soil over one to two days. The system consists of an inflow component, a shallow ponding area over a planted soil bed, mulch layer, gravel filter chamber, attractive shrubs, grasses and flowers, and an overflow mechanism to convey larger rain events to the storm drain system or receiving waters (see Figures 5.42 and 5.43).

Figure 5.41 Profile of a typical rain garden

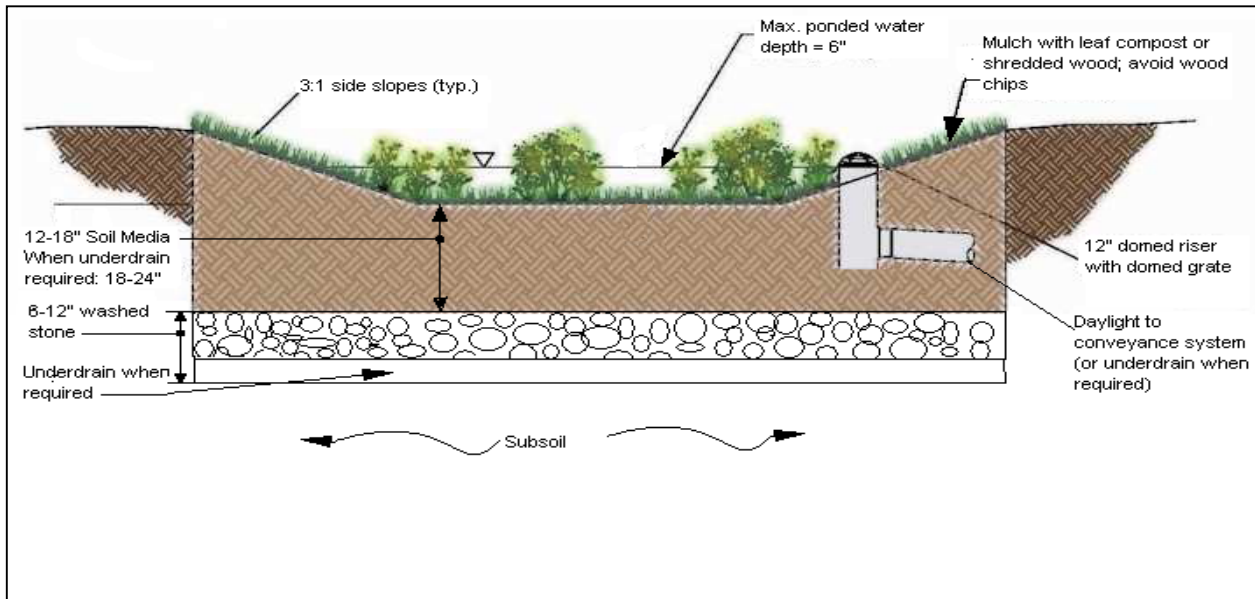
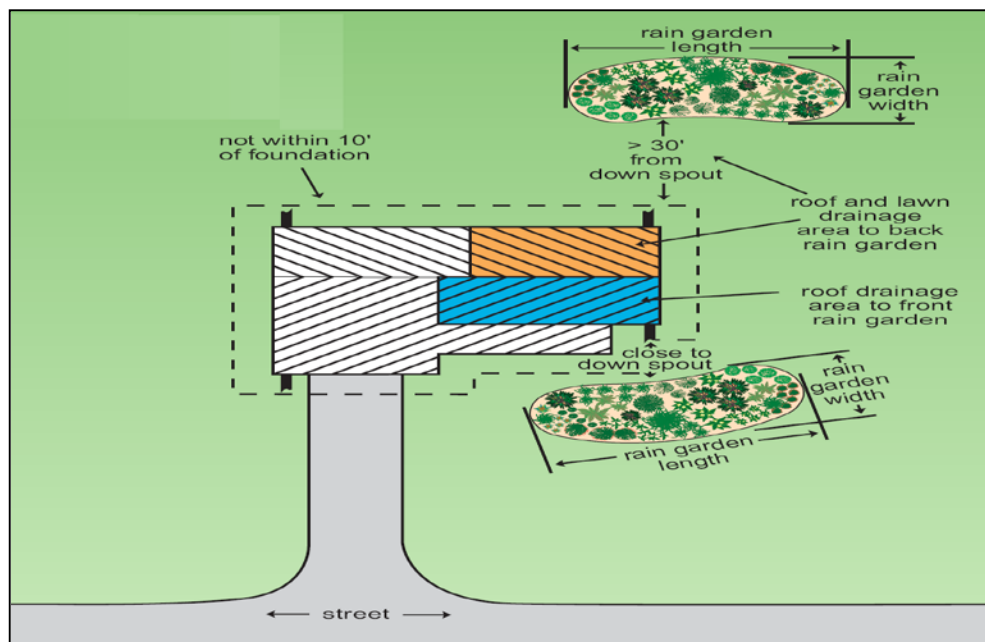

Figure 5.42 Layout of typical rain gardens



Recommended Application of the Practice

The rain garden is suitable for townhouse, single family residential, and in some institutional settings such as schoolyard projects, for treating small volumes of storm runoff from rooftops, driveways, and sidewalks. Since rain gardens do not need to be tied directly into the storm drain system, they can be used to treat areas that may be difficult to otherwise address due to inadequate head or other grading issues. Rain gardens are designed as an “exfilter,” allowing rainwater to slowly seep through the soil. They have a prepared soil mix and should be designed with a deeper gravel drainage layer chamber to improve treatment volume, and to compensate for clays and fines washing into the area. Rain garden size can range from 40 - 300 square feet for a residential area. Rain gardens can be integrated into a site with a high degree of flexibility and work well in combination with other structural management systems, including porous pavement, infiltration trenches, and swales.

Benefits

- Rain gardens can have many benefits when applied to redevelopment and infill projects in urban settings. The most notable include:
- Pollutant treatment for residential rooftops and driveways, (solids, metals, nutrients and hydrocarbons)
- Groundwater recharge augmentation
- Micro-scale habitat

New York State Stormwater Management Design Manual

Chapter 5: Green Infrastructure Practices

Section 5.3 Green Infrastructure Techniques

- Aesthetic improvement to turfgrass or otherwise hard urban surfaces (Figure 5.44)
- Ease of maintenance, coupling routine landscaping maintenance with effective stormwater management control and reduced turfgrass maintenance
- Promotion of watershed education and stewardship
- Rain gardens require a modest land area to effectively capture and treat residential runoff from storms up to approximately the 1-inch precipitation event.

Feasibility/Limitations

Rain gardens have some limitations, similar to bioretention, that restrict their application. The most notable of these include:

- Steep slopes - Rain gardens require relatively flat slopes to be able to accommodate runoff filtering through the system. Some design modifications can address this constraint through the use of berms and timber or block retaining walls on moderate slopes.

Figure 5.43 Rain gardens also have aesthetic value

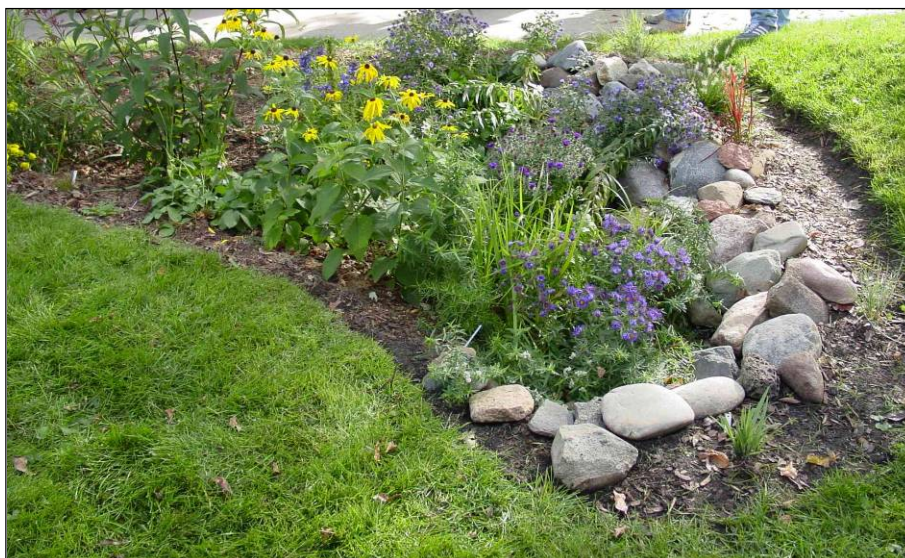

- Compacted and clay sub-soils - Sub-soils compacted by construction and heavy clay soils may need more augmentation by mechanical means (deep tine aeration or deep ripping) to provide appropriate infiltration or should be designed as a filter with under drains. A single rain garden system should be designed to receive sheet flow runoff or shallow concentrated flow from an impervious area or from a roof drain downspout with a total contributing drainage area equal to or less than 1,000 square feet. Treatment of larger drainage areas should incorporate the design elements of bioretention practices. Because the system works by filtration through a planting media, runoff must enter at the surface.
- The rain garden must be sited in a location that allows overflow from the contributing drainage area to sheet flow or be otherwise safely conveyed to the formal drainage system. Rain gardens should be located downgradient and at least 10 feet from basement foundations.
- Rain gardens should not be located in areas with heavy tree cover, as the root systems will make installation difficult and may be damaged by the excavation.

New York State Stormwater Management Design Manual

Chapter 5: Green Infrastructure Practices

Section 5.3 Green Infrastructure Techniques

- Rain gardens cannot be used to treat parking lot or roadway runoff. Treatment of these areas and other areas of increased pollutant loading should incorporate the design elements of a bioretention practice.

Sizing and Design Criteria

Stormwater quantity reduction in rain gardens occurs via evaporation, transpiration, and infiltration, though only the infiltration capacity of the soil and drainage system is considered for water quality sizing. The storage volume of a rain garden is achieved within the gravel drainage layer bed, soil medium and ponding area above the bed. The size should be determined using the water quality volume (WQv), calculated for the drainage area contributing to the rain garden. The storage volume in the rain garden must be equal to or greater than the water quality volume (WQv) in order to receive credit towards the runoff reduction volume. Rain gardens without underdrains in good soils can reduce the total WQv. Those constructed on poor soils cannot achieve runoff reduction more than 40% of total WQv. Instead of using an underdrain, it is recommended to increase the surface area of the rain garden. The available volume in the garden is determined by multiplying the volume of each layer by its porosity and adding the ponding volume. The following sizing criteria is followed to arrive at the minimum surface area of the rain garden, based on the required WQv:

$$WQV \leq V_{SM} + V_{DL} + (D_P \times A_{RG})$$

$$V_{SM} = A_{RG} \times D_{SM} \times n_{SM}$$

$$V_{DL} \text{ (optional)} = A_{RG} \times D_{DL} \times n_{DL}$$

where:

V_{SM} = volume of the soil media [cubic feet]

V_{DL} = volume of the gravel drainage layer [cubic feet]

A_{RG} = rain garden surface area [square feet]

D_{SM} = depth of the soil media, typically* 1.0 to 1.5 [feet]

D_{DL} = depth of the drainage layer, minimum 0.5 [feet]

D_P = depth of ponding above surface, maximum 0.5 feet [feet]

n_{SM} = porosity of the soil media ($\geq 20\%$)

n_{DL} = porosity of the drainage layer ($\geq 40\%$)

WQV = Water Quality Volume [cubic feet], as defined in Chapter 4

A simple example for sizing rain gardens based upon WQv is presented in Table 5.10.

*Maximum depth in soil types C and D is one foot.

New York State Stormwater Management Design Manual

Chapter 5: Green Infrastructure Practices

Section 5.3 Green Infrastructure Techniques

Required Elements

Siting: Rain gardens should be located as close as possible (without causing damage to structures) to the impervious areas that they are intended to treat. Although some vegetated areas will drain to the rain garden, they should be kept to a minimum to maximize the treatment of impervious areas. Rain gardens should be located within approximately 30 feet of the downspout or impervious area treated. Rooftop conveyance to the rain garden is through roof leaders directed to the area, with stone or splash blocks with dispersive stone spreaders placed at the point of discharge into the rain garden to prevent erosion. Runoff from driveways and other paved surfaces should be directed to the rain garden at a non-erosive rate through shallow swales, or allowed to sheet flow across short distances (Figure 5.44).

Sizing: The following considerations should be given to design of the rain garden (after PA Stormwater Design Manual, Bannerman 2003 and LID Center):

- Ponding depth above the rain garden bed should not exceed 6 inches. The recommended maximum ponding depth of 6 inches provides surface storage of stormwater runoff, but is not too deep to affect plant health, safety, or create an environment of stagnant conditions. On perfectly flat sites, this depth is achieved through excavation of the rain garden and backfilling to the appropriate level; on sloping sites, this depth can be achieved with the use of a berm on the downslope edge, and excavation/backfill to the required level.
- Surface area is dependent upon storage volume requirements but should not exceed a loading ratio of 5:1 (drainage area to infiltration area, where drainage area is assumed to be 100% impervious; to the extent that the drainage area is not 100% impervious, the loading ratio may be modified).
- A length to width ratio of 2:1 with long axis perpendicular to slope and flow path is recommended.

Soil: The composition of the soil media should consist of 50%-70% sand (less than 5% clay content), 50%-30% topsoil with an average of 5% organic material, such as compost or peat, free of stones, roots and woody debris and animal waste.. The depth of the amended soil should be approximately 4 inches below the bottom of the deepest root ball.

Table 5.10 Rain Garden Simple Sizing Example

Given a 1,000 square foot impervious drainage area (e.g., rooftop), a rain garden design has been proposed with a 200 square foot surface area, a soil layer depth of 12 inches, a drainage layer depth of 6 inches, and an allowable ponding depth of 3 inches. Evaluate if the proposed rain garden design satisfies site WQv requirements

Step 1: Calculate water quality volume using the following equation:

$$WQv = \frac{(P)(Rv)A}{12}$$

where:

P = 90% rainfall number = 0.9 in

Rv = 0.05+0.009 (I) = 0.05+0.009(100) = 0.95

I = Percentage impervious area draining to site = 100%

A = Area draining to practice (treatment area) = 1,000 ft²

$$WQv = \frac{(0.90)(0.95)1,000}{12} \quad WQv = 71.25 \text{ ft}^3$$

Step 2: Solve for drainage layer and soil media storage volume:

$$V_{SM} = A_{RG} \times D_{SM} \times P_{SM}$$

$$V_{DL} = A_{RG} \times D_{DL} \times P_{DL}$$

where:

A_{RG} = proposed rain garden surface area = 200 ft²

D_{SM} = depth soil media = 12 inches = 1.0 ft

D_{DL} = depth drainage layer = 6 inches = 0.5 ft

P_{SM} = porosity of soil media = 0.20

P_{DL} = porosity of drainage layer = 0.40

$$V_{SM} = 200 \text{ ft}^2 \times 1.0 \text{ ft} \times 0.20 = 40 \text{ ft}^3$$

$$V_{DL} = 200 \text{ ft}^2 \times 0.5 \text{ ft} \times 0.40 = 40 \text{ ft}^3$$

D_P = ponding depth = 3 inches = 0.25 ft

$$WQv \leq V_{SM} + V_{DL} + (D_P \times A_{RG}) = 40 \text{ ft}^3 + 40 \text{ ft}^3 + (0.25 \text{ ft} \times 200 \text{ ft}^2)$$

$$WQv = 71.25 \text{ ft}^3 \leq 130.0 \text{ ft}^3, \text{ OK}$$

Therefore, the proposed design for treating an area of 1,000 ft² exceeds the WQv requirements. Since this is a contained rain garden without underdrains, the full WQv for the contributing drainage area (71.25 ft³) is credited towards the runoff reduction volume (Step 3)

New York State Stormwater Management Design Manual

Chapter 5: Green Infrastructure Practices

Section 5.3 Green Infrastructure Techniques

Construction Rain gardens should initially be dug out to a 24” depth, then backfilled with a 6-12 inch layer of clean washed gravel (approximately 1.5-2.0 inch diameter rock), and filled back to the rain garden bed depth with the design soil mix. When an underdrain is used, excavate to 30-36” depth, backfill with 12” stone, fill with 18-24” design soil mix. Rain gardens should only be installed when surrounding landscapes are stabilized and not subject to erosion.

Environmental/Landscaping Elements

The rain garden system relies on a successful native plant community to stabilize the ponding area, promote infiltration, and uptake pollutants. To do that, plant species need to be selected that are adaptable to the wet/dry conditions that will be present. The goal of planting the rain garden is to establish an attractive planting bed with a mix of upland and wetland native shrubs, grasses and herbaceous plant material arranged in a natural configuration starting from the more upland species at the outermost zone of the system to more wetland species at the innermost zone. Plants shall be container-grown with a well-established root system, planted on one-foot centers. Table 5.11 provides a representative list of suggested plant selections. Rain gardens shall not be seeded as this takes too long to establish the desired root system, and seed may be floated out with rain events. The same limitation is true for plugs. Shredded hardwood mulch should be applied up to 2” to help keep soil in place.

New York State Stormwater Management Design Manual

Chapter 5: Green Infrastructure Practices

Section 5.3 Green Infrastructure Techniques

Table 5.11 Suggested Rain Garden Plant List	
Shrubs	Herbaceous Plants
Witch Hazel <i>Hamamelis virginiana</i>	Cinnamon Fern <i>Osmunda cinnamomea</i>
Winterberry <i>Ilex verticillata</i>	Cutleaf Coneflower <i>Rudbeckia laciniata</i>
Arrowwood <i>Viburnum dentatum</i>	Woolgrass <i>Scirpus cyperinus</i>
Brook-side Alder <i>Alnus serrulata</i>	New England Aster <i>Aster novae-angliae</i>
Red-Osier Dogwood <i>Cornus stolonifera</i>	Fox Sedge <i>Carex vulpinoidea</i>
Sweet Pepperbush <i>Clethra alnifolia</i>	Spotted Joe-Pye Weed <i>Eupatorium maculatum</i>
	Switch Grass <i>Panicum virgatum</i>
	Great Blue Lobelia <i>Lobelia siphatica</i>
	Wild Bergamot <i>Monarda fistulosa</i>
	Red Milkweed <i>Asclepias incarnate</i>
Adapted from NYSDM Bioretention Specifications, Bannerman, Brooklyn Botanic Garden.	

Maintenance

Rain gardens are intended to be relatively low maintenance. However, these practices may be subject to sedimentation and invasive plant species which could create maintenance problems. If the recharge ability is lost by accumulation of fine sediment, mosquito breeding may occur. Adequate arrangements for long-term maintenance of these systems and updated inventories of their location are essential for the long-term performance of these practices. Rain gardens should be treated as a component of the landscaping, with routine maintenance specified through a legally binding maintenance agreement. Routine maintenance may include the occasional replacement of plants, mulching, weeding and thinning to maintain the desired appearance. Weeding and watering are essential the first year, and can be minimized with the use of a weed-

New York State Stormwater Management Design Manual

Chapter 5: Green Infrastructure Practices

Section 5.3 Green Infrastructure Techniques

free mulch layer. Studies have found that rain gardens, especially when native plants are used, are well accepted if they appear orderly and well maintained. Homeowners and landscapers must be educated regarding the purpose and maintenance requirements of the rain garden, so the desirable aspects of ponded water are recognized and maintained.

Select lower growing species that stay upright. Keep plants pruned if they start to get “leggy” and floppy. Cut off old flower heads after a plant is done blooming. Keeping the garden weeded is one of the most important tasks, especially in the first couple of years while the native plants are establishing their root systems. Once the rain garden has matured, the garden area should be free of bare areas except where stepping stones are located.

Inspect for sediment accumulations or heavy organic matter where runoff enters the garden and remove as necessary. The top few inches of planting soil should be removed and replaced when water ponds for more than 48 hours. Blockages may cause diversion of flow around the garden. If the garden overflow device is an earthen berm or lip, check for erosion and repair as soon as possible. If this continues, a harder armoring of stone may be necessary. Make sure all appropriate elevations have been maintained, no settlement has occurred and no low spots have been created.

References/Further Resources

Bannerman, Roger. 2003. Rain Gardens, a How-to Manual for Homeowners. University of Wisconsin. PUB-WT-776.

Brooklyn Botanic Garden. 2004. Using Spectacular Wetland Plantings to Reduce Runoff.

Iowa Rain Garden Design and Installation Manual, 2008 www.iowastormwater.org

Low Impact Development Center, Inc. (LID) <http://www.lid-stormwater.net/intro/sitemap.htm#permpavers>

Pennsylvania Stormwater Best Management Practices Manual. Draft 2005.

Rain Gardens, A hoe-to manual for homeowners, Wisconsin department of Natural Resources DNR Publication PUB-WT-776 2003.

5.3.8 Green Roofs

Description: Green roofs consist of a layer of vegetation and soil installed on top of a conventional flat or sloped roof (Figure 5.45). The rooftop vegetation captures rainwater allowing evaporation and evapotranspiration processes to reduce the amount of runoff entering downstream systems, effectively reducing stormwater runoff volumes and attenuating peak flows. Green roof designs are characterized as *extensive* or *intensive*, depending on storage depth. *Extensive* green roofs have a thin soil layer and are lighter, less expensive and generally require low maintenance. *Intensive* green roofs often have pedestrian access and are characterized by a deeper soil layer with greater weight, higher capital cost, increased plant diversity and more maintenance requirements.

The general components of any green roof system include:

- a roof structure capable of supporting the weight of a green roof system
- a waterproofing barrier layer designed to protect the building and roof structure
- a drainage layer consisting of a porous media capable of water storage for plant uptake and storm buffering
- a geosynthetic layer to prevent fine soil media from clogging the porous media soil with appropriate characteristics to support selected green roof plants
- plants with appropriate tolerance for regional climate variation, harsh rooftop conditions and shallow rooting depths

Figure 5.44 Green roof installed on a sloped roof, Tupper Lake, NY



http://www.fcwc.org/WEArchive/010203_wbj/rain.htm

See Figure 5.46 for a schematic of the various layers included in a typical green roof system.

Recommended Application of Practice

Green roofs are suitable for retrofit or redevelopment projects as well as new buildings, and can be installed on small garages or larger industrial, commercial and municipal buildings. Green roofs present an above-ground management alternative when on-site space for stormwater practices is limited. Green roofs can be installed on flat roofs or on roofs with slopes up to 30% provided special strapping and erosion control

New York State Stormwater Management Design Manual

Chapter 5: Green Infrastructure Practices

Section 5.3 Green Infrastructure Techniques

devices are used (Peck and Kuhn, 2003).

Generally, extensive green roofs can be built on flat or sloped roofs; whereas intensive systems are built on flat or tiered roofs.

Green roofs are most effective in reducing runoff volume and rates for land uses with high percentages of rooftop coverage such as commercial, industrial and multifamily housing (Stephens *et al.*, 2002). Green roofs on lots with approximately 70% impervious area have been shown to retain as much as 80% of the total annual runoff in regions with low total annual rainfall and 30% in areas with high total annual rainfall (Stephens *et al.*, 2002), which encompasses the range of performance likely to be observed in New York State.

Benefits

Green roofs reduce runoff volumes and delay peak flows while providing a number of other benefits to the urban environment, private building owners, and the public. If roof runoff is at least partly controlled at the source, the size of other BMPs throughout the site can be reduced. The most notable include:

- Green roofs help achieve stormwater management goals by reducing total annual runoff volumes (Roofscapes, Inc., 2005).
- The layers of soil and vegetation on the rooftop moderate interior building temperatures and provide insulation from the heat and cold. This reduces the amount of energy required to heat and cool the building, providing energy savings to the owner. The increased insulation reduces HVAC infrastructure requirements and therefore building construction costs.
- The additional rooftop insulation protects rooftop materials from ultraviolet radiation and extreme temperature

Figure 5.45 Green roof layers

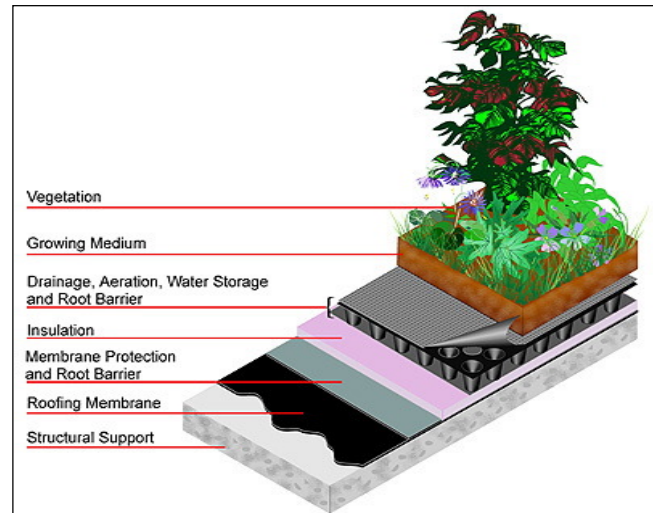

<http://www.uwm.edu/Dept/GLWI/ecoli/Greenroof/images/greenroofcom.jpg>

Figure 5.46 Green roof on a Manhattan apartment building along the Hudson River



Photo courtesy of Cesar Pelli & Associates

New York State Stormwater Management Design Manual

Chapter 5: Green Infrastructure Practices

Section 5.3 Green Infrastructure Techniques

fluctuations, which deteriorates standard roofing materials. It is estimated that green roofs can extend the life of a standard roof by as long as 20 years (Velazquez, 2005).

- Green roofs can be designed to insulate the building interior from outside noise, and sound-absorbing properties of green roof infrastructure can make surrounding areas quieter.
- Fully saturated green roofs provide fire resistance and inhibit the spread of fire from adjacent buildings.
- Green roofs reduce the urban heat island effect by cooling and humidifying the surrounding air.
- Green roofs help filter and bind airborne dust and other particulates, improving air quality (Barr Engineering Company, 2003).
- The additional rooftop vegetation within an urban or suburban environment creates habitat for birds and butterflies.
- With thoughtful design, green roofs can be aesthetically pleasing and improve views from neighboring buildings as illustrated in Figure 5.47, a high-rise residential building in Manhattan.
- A benefit specific to intensive green roofs is pedestrian access to a scenic space within an urban environment, as illustrated in Figure 5.48.

Figure 5.47 Green roof: High Line Park, NYC



Feasibility/Limitations

The primary limitation to the implementation of green roofs is increased design and construction costs. Green roof designs need to include any structural requirements necessary to support the additional weight of soil, vegetation, and possibly pedestrians. For retrofit projects, a licensed structural engineer or architect must conduct a structural analysis for retrofit of the existing structures, which will dictate the type of green rooftop system and any necessary structural reinforcement. Other limitations include:

- Damage to or failure of waterproofing elements present a risk of causing water damage. However, as with traditional roof installations, a warranty can help guarantee that any damage to the water proofing system will be repaired.
- Extreme weather conditions can impact plant survival.
- Green roof maintenance is higher than that for traditional roofs.
- Safe access to the rooftop should be provided for construction and maintenance.

New York State Stormwater Management Design Manual

Chapter 5: Green Infrastructure Practices

Section 5.3 Green Infrastructure Techniques

- Supplemental irrigation during the first year may be necessary to establish vegetation, and a long-term supplemental irrigation system may be required for some intensive systems.
- In cold climates, snow loads need to be accounted for in determining the structural capacity required to install a green roof system.
- In many building designs it will likely be more feasible to incorporate an extensive green roof design versus an intensive system.

Sizing and Design Criteria

Stormwater treatment in green roofs occurs via evaporation, transpiration, and filtration. The green roof area is pervious and so can be applied towards meeting the total impervious cover reduction target to address water quality volume in redevelopment sites. The green roof area can be used as either an impervious area reduction or a volume reduction, but not both. For new development, the water quality volume for the green roof is applied towards the runoff reduction volume, provided that the storage provided within the roof structure is equal to or greater than the calculated WQv. Stormwater storage volume sizing calculations are outlined below. The storage media depth can be adjusted so the media storage is equivalent to the New York Unified Stormwater Sizing Criteria for water quality volume or the excess storage volume may be used to temporarily store all or some of the one year storm to meet the Channel Protection requirements.

$$\text{Storage Volume} = V_{SM} + V_{DL} + (D_P \times A_{GR})$$

$$V_{SM} = A_{GR} \times D_{SM} \times n_{SM}$$

$$V_{DL} = A_{GR} \times D_{DL} \times n_{DL}$$

where:

V_{SM} = volume of the soil media [cubic feet]

V_{DL} = volume of the drainage layer [cubic feet]

A_{GR} = green roof surface area [square feet]

D_{SM} = depth of the soil media [0.25 to 0.5 feet for extensive; 0.5 to 2.0 feet for intensive]

D_{DL} = depth of the drainage layer [feet]

D_P = depth of ponding above surface [feet]

n_{SM} = porosity of the soil media (~20%)

n_{DL} = porosity of the drainage layer (~25%)

WQv = Water Quality Volume [cubic feet], as defined in Chapter 4 of the NYS DM

A simple example for sizing green roofs based on WQv is presented in Table 5.12 below:

New York State Stormwater Management Design Manual

Chapter 5: Green Infrastructure Practices

Section 5.3 Green Infrastructure Techniques

Table 5.12 Simple Green Roof Sizing Example

A green roof has been designed for a 1,100 square foot rooftop. The proposed system has a 900 sq ft surface area, a 3 inch soil media layer, and a 2 inch drainage layer. Given the proposed design, evaluate if the proposed green roof design satisfies site WQv requirements:

Step 1: Calculate water quality volume using the following equation:

$$WQv = \frac{(P)(Rv)A}{12}$$

where:

P = 90% rainfall number = 0.9 in

Rv = 0.05+0.009 (I) = 0.05+0.009(100) = 0.95

I = the percentage of impervious area draining to site = 100%

A = area draining to practice = 1,100 ft²

$$WQv = \frac{(0.90)(0.95)1,100}{12}$$

$$WQv = 78.4 \text{ ft}^3$$

Step 2: Calculate the drainage layer and soil media storage volume:

$$V_{SM} = A_{GR} \times D_{SM} \times P_{SM}$$

$$V_{DL} = A_{GR} \times D_{DL} \times P_{DL}$$

where:

A_{GR} = green roof surface area = 900 ft²

D_{SM} = depth soil media = 3 inches = 0.25 ft

D_{DL} = depth drainage layer = 2 inches = 0.17 ft

P_{SM} = porosity of soil media = 0.20

P_{DL} = porosity of drainage layer = 0.25

V_{SM} = 900 ft² x 0.25 ft x 0.20 = 45.0 ft³

V_{DL} = 900 ft² x 0.17 ft x 0.25 = 38.25 ft³

D_P = ponding depth = 0.5 inches = 0.04 ft

Storage Volume = V_{SM}+V_{DL}+(D_P x A_{GR}) = 45.0 ft³ + 38.25 ft³ + (0.04 ft x 900 ft²)=119.25

$$WQv = 78.4 \text{ ft}^3 < 119.25 \text{ ft}^3$$

Therefore, the proposed design satisfies the WQv storage requirements. The extra storage volume provided within the green roof can be used to treat small impervious areas immediately adjacent to the roof (such as walkways, skylights, etc...) or for storage of the Channel Protection storm. The WQv of 78.4 ft³ is applied towards the runoff reduction volume.

Figure 5.49 Extensive cross-section

Required Elements

Each green roof project is unique, given the purpose of the building, its architecture and the preferences of its owner and end user. However, several key design features should be kept in mind during the design of any green rooftop systems.

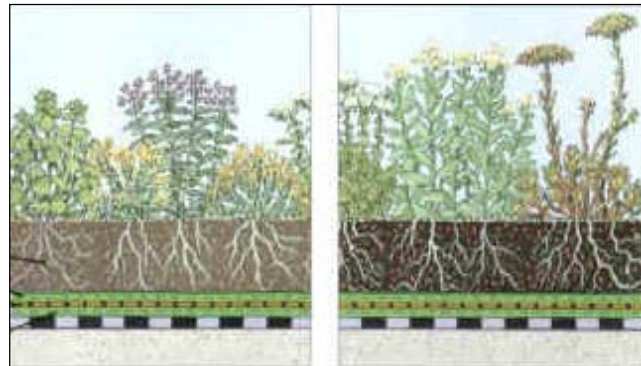

Extensive systems are characterized by low weight, lower capital cost, and minimal plant diversity (Figure 5.49). The growing medium is usually a mixture of sand, gravel, crushed brick, peat, or organic matter combined with soil. The soil media ranges between three and six inches in depth and increases the roof load by 16 to 50 pounds per square foot when fully saturated. Since the growing medium is shallow and the microclimate is harsh, plant species used in extensive systems should be low and hardy, which typically involves alpine, arid, or indigenous species.

Intensive systems have a deeper soil layer and a corresponding greater weight (Figure 5.50). The growing medium is often soil based and ranges in depth from six to 24 inches, with a saturated roof loading of between 50 and 200 pounds per square foot. Designers can use a diverse range of trees, shrubs and groundcover because the deeper growing medium allows longer root systems. This allows the designer to develop a more complex ecosystem. Both a structural engineer and an experienced installer are required for design and installation of intensive systems

Figure 5.48 Intensive cross-section

The five principal components of any green roof system are roof structure, waterproofing, drainage system, soil media and planting types. General design guidelines for each of these components are described below.

Roof Structure: The load bearing capacity of the roof structure is critical for the support of soil, plants, and any people who will be accessing the green roof (for either maintenance or recreation). Generally, green roofs weighing more than 17 pounds per square foot (saturated) require consultation with a structural engineer (Barr Engineering, 2003). As a fire resistance measure, non-vegetative materials, such as stone or pavers should be installed

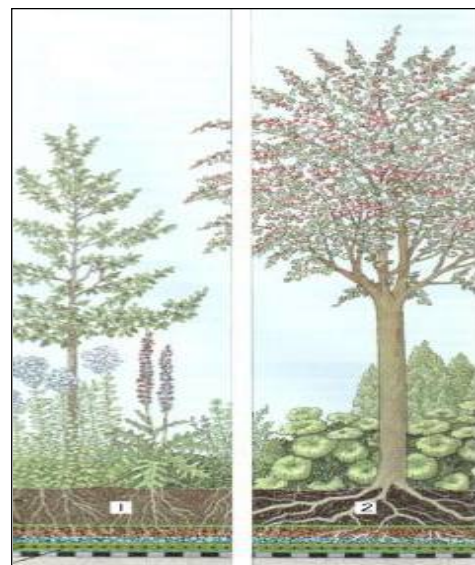

New York State Stormwater Management Design Manual

Chapter 5: Green Infrastructure Practices

Section 5.3 Green Infrastructure Techniques

around all rooftop openings and at the base of all walls that contain openings (Barr Engineering, 2003). On sloped roofs additional erosion control measures, such as cross-battens, may be necessary to stabilize drainage layers.

Waterproofing: In a green roof system the first layer above the roof surface is a waterproofing membrane. Two common waterproofing techniques used for the construction of green roofs are monolithic and thermoplastic sheet membranes. An additional protective layer is generally placed on top of either of these membranes followed by a physical or chemical root barrier. Once the waterproofing system has been installed it should be fully tested prior to construction of the drainage system.

Drainage System: The drainage system includes a porous drainage layer and a geosynthetic filter mat to prevent fine soil particles from clogging the porous media. The drainage layer can be made up of gravels or recycled-polyethylene materials that are capable of water retention and efficient drainage. The depth of the drainage layer depends on the load bearing capacity of the roof structure and the stormwater retention requirements. Once the porous media is saturated excess water should be directed to a traditional rooftop storm drain system. The porosity of the drainage system should be greater than or equal to 25% (Cahill Associates, 2005).

Soil: The soil layer above the drainage system is the growing media for the plants in a green roof system. Soils used in green roofs are generally lighter than standard soil mixes, and consist of 75% mineral and 25% organic material (Barr Engineering, 2003), and no clay size particles. The chemical characteristics of the soil (e.g., pH, nutrients, etc.) should be carefully selected in consideration with the planting plan. The porosity of the soil layer, measured as non-capillary pore space at field capacity, should be greater than or equal to 15% (Cahill Associates, 2005).

Planting Types

Plant selection for green rooftops is governed by local climate and design objectives. The range of plants suitable for roof landscapes is limited by the extremes of the rooftop microclimate including high wind, drought and low winter temperatures. A qualified botanist or landscape architect should be consulted when choosing plant material. For extensive systems, plant material should be confined to hardier or indigenous varieties of grass and sedum. Root size and depth should also be considered to ensure that the plants stabilize the shallow depth of soil media. Plant choices can be much more diverse for intensive systems. The height of the roof, its exposure to wind, snow loading potential, its orientation to the sun and shading by surrounding buildings all have an impact on the selection of appropriate vegetation. Several years are required for a green

New York State Stormwater Management Design Manual

Chapter 5: Green Infrastructure Practices

Section 5.3 Green Infrastructure Techniques

roof to reach its optimum performance (Cahill Associates, 2005 - Draft Pennsylvania Stormwater Management Manual). Plantings such as the following may be considered for New York State temperate zones:

- [Allium schoenoprasum](#)
- [Sedum acre 'Aureum'](#)
- [Sedum album](#)
- [Sedum album 'Murale'](#)
- [Sedum floriferum 'Weihenstephaner Gold'](#)
- [Sedum kamtschaticum](#)
- [Sedum reflexum](#)
- [Sedum sexangulare](#)
- [Sedum spurium 'Fuldaglut'](#)
- [Sedum spurium 'John Creech'](#)
- [Sedum spurium 'Roseum'](#)
- [Sedum spurium 'White Form'](#)
- [Talinum calycinum](#)

Maintenance

Green roof maintenance may include watering, fertilizing and weeding and is typically greatest in the first two years as plants become established. Roof drains should be cleared when soil substrate, vegetation or debris clog the drain inlet. Maintenance largely depends on the type of green roof system installed and the type of vegetation planted. Maintenance requirements in intensive systems are generally more costly and continuous, compared to extensive systems. The use of native vegetation is recommended to reduce plant maintenance in both extensive and intensive systems.

A green roof should be monitored after completion for plant establishment, leaks and other functional or structural concerns. Vegetation should be monitored for establishment and viability, particularly in the first two years. Irrigation and fertilization is typically only a consideration during the first year before plants are established. After the first year, maintenance consists of two visits per year for weeding of invasive species, and safety and membrane inspections (Magco, 2003).

New York State Stormwater Management Design Manual

Chapter 5: Green Infrastructure Practices

Section 5.3 Green Infrastructure Techniques

References/Further Resources

ASTM E2396 - 05 Standard Test Method for Saturated Water Permeability of Granular Drainage Media [Falling-Head Method] for Green Roof Systems

ASTM E2397 - 05 Standard Practice for Determination of Dead Loads and Live Loads associated with Green Roof Systems.

ASTM E2398 - 05 Standard Test Method for Water Capture and Media Retention of Geocomposite Drain Layers for Green Roof Systems

ASTM E2399 - 05 Standard Test Method for Maximum Media Density for Dead Load Analysis of Green Roof Systems (includes tests to measure moisture retention potential and saturated water permeability of media).

ASTM E2400 - 06 Standard Guide for Selection, Installation, and Maintenance of Plants for Green Roof

ASTM E631 - 06 Standard Terminology of Building Constructions

ASTM C29 / C29M - 07 Standard Test Method for Bulk Density ("Unit Weight") and Voids in Aggregate

ASTM E2114 - 08 Standard Terminology for Sustainability Relative to the Performance of Buildings

ASTM WK7319 - New Standard Guide for Use of Expanded Shale, Clay or Slate (ESCS) as a Mineral Component in Growing Media for Green Roof Systems (std. still in development as of June 2009).

Barr Engineering Company. 2003. Minnesota Urban Small Sites BMP Manual: Stormwater Best Management Practices for Cold Climates. Metropolitan Council Environmental Services. St. Paul, Minnesota. <http://www.metrocouncil.org/environment/Watershed/bmp/manual.htm>

Cahill Associates, Inc. January 2005. Draft Pennsylvania Stormwater Best Management Practices Manual, Department of Environmental Protection, Bureau of Stormwater Management, and Division of Waterways, Wetlands, and Erosion Control.

City of Chicago. Accessed 2005. *Guide to Rooftop Gardening*
http://egov.cityofchicago.org/webportal/COCWebPortal/COC_ATTACH/GuidetoRooftopGardening_v2.pdf

City of Portland. 2000. *Stormwater Management Manual*. City of Portland. Portland, Oregon.

Flinker, P., 2005. Rhode Island Urban Environmental Design Manual "Green Rooftop Systems" Narrative. Sustainable Watersheds Office Rhode Island Department of Environmental Management.
<http://www.dem.ri.gov/programs/bpoladm/suswshed/pubs.htm>

Liptan, T. and E. Strecker. 2003. *Ecoroofs – A More Sustainable Infrastructure*. Presented at Urban Stormwater: Enhancing Programs at the Local Level. February 17-20, 2003. Cosponsored by US EPA, Chicago Botanic Gardens and Conservation Technology Information Center. Chicago, Illinois.

New York State Stormwater Management Design Manual

Chapter 5: Green Infrastructure Practices

Section 5.3 Green Infrastructure Techniques

Magco, Inc. Accessed 2003. Intensive and Extensive Green Roofs.
http://www.magco.com/extensive_intensive.html

Maryland Department of the Environment. Green Roof - Fact Sheet. Maryland's Stormwater Management Manual. http://www.mde.state.md.us/assets/document/sedimentStormwater/SWM_greenroof.pdf

Peck, S. and M. Kuhn. Accessed 2003. *Design Guidelines for Green Roofs*. http://www.cmhc-schl.gc.ca/en/imquaf/himu/himu_002.cfm

Roofscapes, Inc. Accessed 2005. Green Technology for the Urban Environment. www.roofmeadow.com.

Snodgrass, E. Accessed 2003. <http://www.greenroofplants.com/>

Stephens, K. A., Graham, P. and D. Reid. 2002. *Stormwater Planning: A Guidebook for British Columbia*. British Columbia Ministry of Water, Land and Air Protection.

The Cardinal Group, Inc. Accessed 2002. www.greenroofs.ca.

Velazquez, L. S. 2005. *Greenroofs.com*. <http://www.greenroofs.com>

5.3.9 Stormwater Planters

Description: Stormwater planters are small landscaped stormwater treatment devices that can be placed above or below ground and can be designed as infiltration or filtering practices. Stormwater planters use soil infiltration and biogeochemical processes to decrease stormwater quantity and improve water quality, similar to rain gardens and green roofs. Three versions of stormwater planters include contained planters, infiltration planters, and flow-through planters.

A contained planter is essentially a potted plant placed above an impervious surface (Figure 5.51). Stormwater infiltrates through the soil media within the container, and overflows when the void space or infiltration capacity of the container is exceeded.

An infiltration planter is a contained planter with a pervious bottom that allows stormwater to infiltrate through the soil media within the planter and pass into the underlying soil matrix (Figure 5.52). A flow-through planter is a contained planter

Figure 5.50 Contained storm water planter

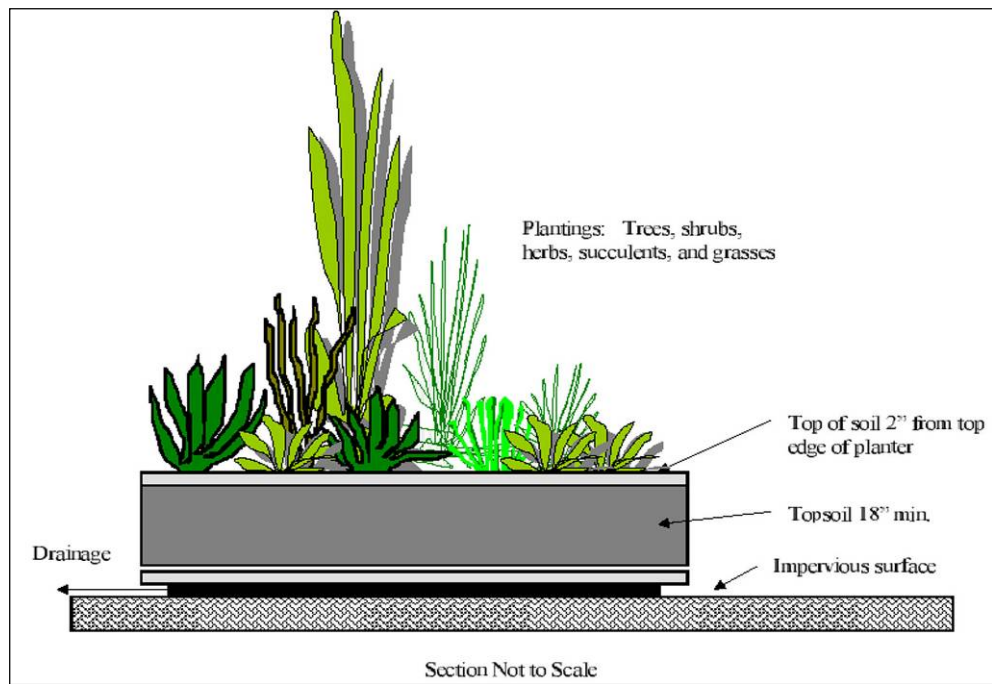

with an under drain system that conducts filtered stormwater to the storm drain system or downstream waterway (Figure 5.53).

All three types of stormwater planters include three common elements: planter “box” material (e.g., wood or concrete); growing medium consisting of organic soil media; and vegetation. Infiltration and flow-through planters may also include splash rock, filter fabric, gravel drainage layer, and perforated pipe.

Recommended Application of the Practice

Figure 5.51 Infiltration stormwater planter

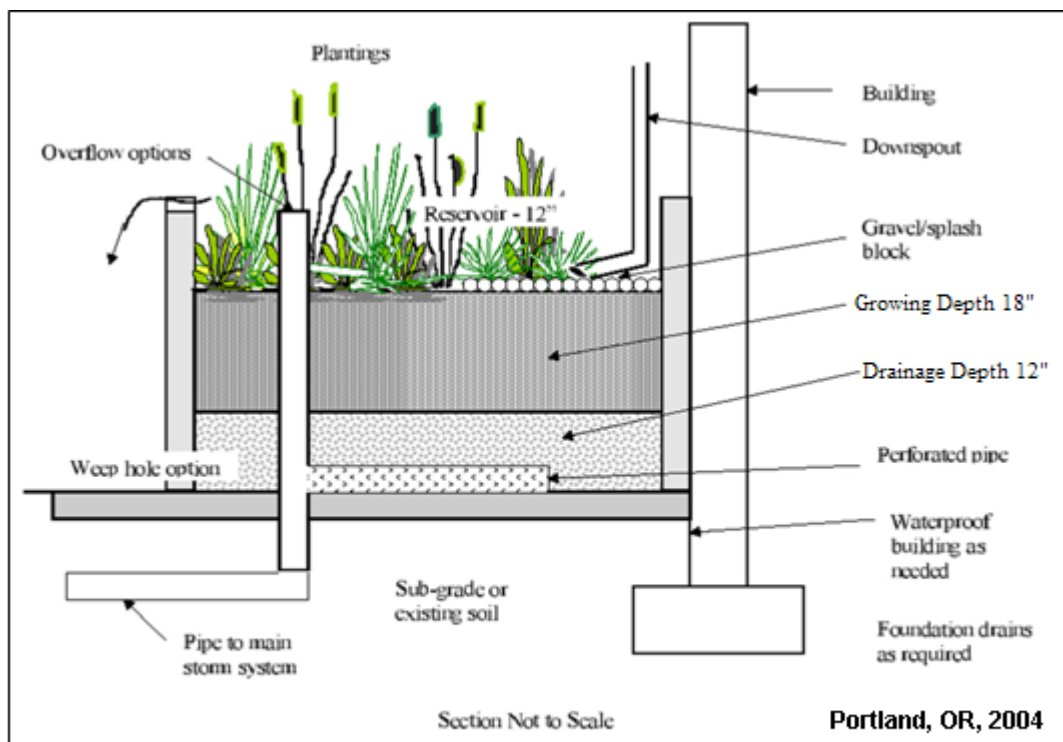

The versatility of stormwater planters makes them uniquely suited for urban redevelopment sites. Depending on the type, they can be placed adjacent to buildings, on terraces or rooftops. Building downspouts can be placed directly into infiltration or flow-through planters; whereas contained planters are designed to capture rainwater, essentially decreasing the site impervious area. The infiltration and adsorption properties of stormwater planters make them well suited to treat common pollutants found in rooftop runoff, such as nutrients, sediment and dust, and bacteria found in bird feces. Stormwater planters are most effective at treating small storm events because of their comparatively small individual treatment capacity.

Benefits

Stormwater planters provide many stormwater management benefits, among them:

- If on-site soils or a high seasonal groundwater table are not suitable for infiltration practices (e.g. rain garden or infiltration trench), flow-through or contained stormwater planters make filtration treatment possible.
- Stormwater planters can reduce stormwater volumes and velocities discharging from treated impervious areas.

Figure 5.52 Flow-through stormwater planter

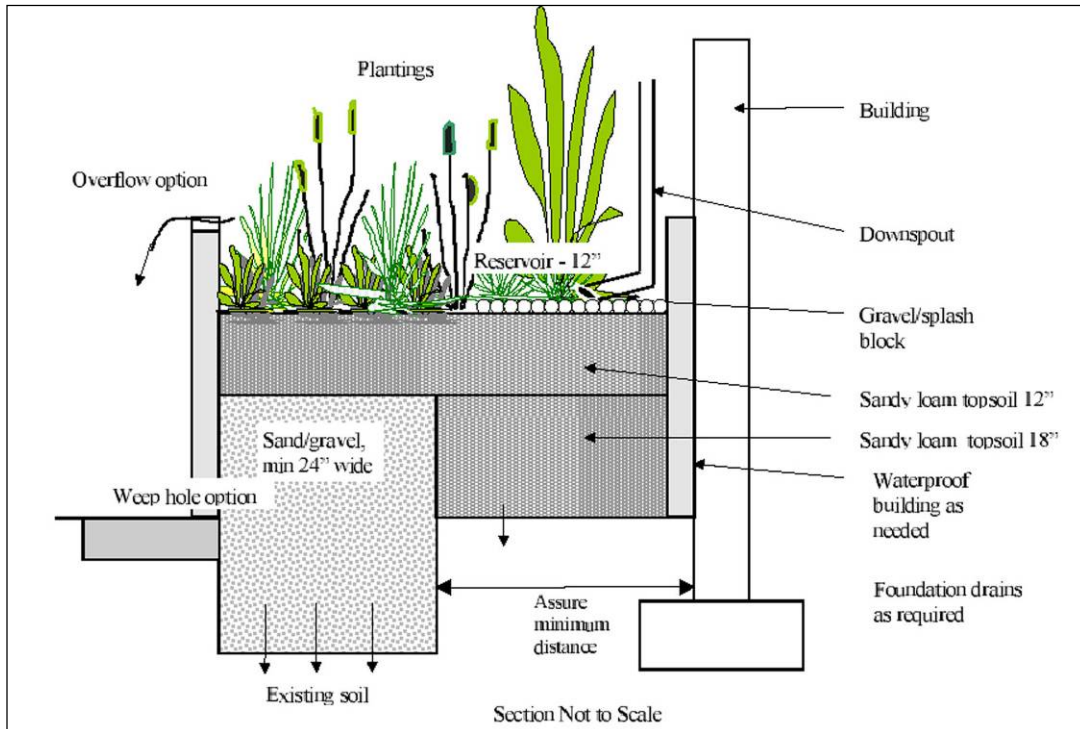

- Flow-through or contained planters do not require a setback from a building foundation, though appropriate waterproofing technology should be incorporated into the design.
- Planters create an aesthetic landscape element, as well as providing micro-habitat within an urban environment.

Feasibility/Limitations

The primary limitation to the use of stormwater planters is their size. They are by definition small-scale stormwater treatment cells that are not well suited to treat runoff from large storm events, or large surface areas. They can, however, be used in series or to augment other stormwater management practices. Other limitations include:

- Stormwater planters are not designed to treat runoff from roadways or parking lots but are ideally suited for treating rooftop or courtyard/plaza runoff.
- Flow-through and infiltration stormwater planters should not receive drainage from impervious areas greater than 15,000 square feet.
- For all three types of stormwater planters, if the infiltration capacity of the soil is exceeded, the planter will overflow. Excess stormwater needs to be directed to a secondary treatment system or released untreated to the storm drain system.

Sizing and Design Criteria

New York State Stormwater Management Design Manual

Chapter 5: Green Infrastructure Practices

Section 5.3 Green Infrastructure Techniques

Stormwater planters should initially be sized to satisfy the WQv requirements for the impervious surface area draining to the practice. This does not apply to contained planters because they are designed to decrease impervious area, not receive additional runoff from adjacent surfaces. The basis for the sizing guidance is the same as that for bioretention (see Chapter 6 of the New York Stormwater Management Design Manual) and relies on the principles of Darcy's Law, where water is passed through porous media with a given head, a given hydraulic conductivity, over a given timeframe (Flinker, 2005). The equation for sizing an infiltration or flow-through stormwater planter based upon the contributing area is as follows:

$$A_f = WQv \times (d_f) / [k \times (h_f + d_f)(t_f)]$$

where:

A_f = the required surface area [square feet]

WQv = water quality volume [cubic feet], as defined in Chapter 4 of this Design Manual

d_f = depth of the soil medium [feet]

k = the hydraulic conductivity [ft/day], usually set at 4 ft/day when soil is loosely placed in the planter, but can be varied depending on the properties of the soil media. Some other reported conductivity values are:

Sand: 3.5 ft/day (City of Austin 1988).

Peat: 2.0 ft/day (Galli 1990).

Leaf compost: 8.7 ft/day (Claytor and Schueler, 1996).

Bioretention Soil: 0.5 ft/day (Claytor and Schueler, 1996).

h_f = average height of water above the planter bed [≤ 6 inches for a maximum ponding depth of 12 inches]

t_f = the design time to filter the treatment volume through the filter media [usually set at 3 to 4 hours]

Required Elements

There are a number of sizing, siting, and material specification guidelines that should be consulted during stormwater planter design.

SITING

- Flow-through and infiltration stormwater planters should not receive drainage from impervious areas greater than 15,000 square feet.
- Infiltration planters should be located a minimum distance of ten feet from structures.
- To prevent erosion, splash rocks should be placed below downspouts or where stormwater enters the planter.

New York State Stormwater Management Design Manual

Chapter 5: Green Infrastructure Practices

Section 5.3 Green Infrastructure Techniques

SIZING

- Stormwater planters should be designed to pond water for less than 12 hours, with a maximum ponding depth of 12 inches.
- An overflow control should redirect high flows to the storm drain system or an alternative treatment facility.
- Generally, flow-through and infiltration planters should have a minimum width of 1.5 and 2.5 feet, respectively.

SOIL

- Soil specifications for the stormwater planter growing medium should allow an infiltration rate of 2 inches per hour, and 5 inches an hour for the drainage layer.
- Soil compaction must be no greater than 85% in the planter.
- The growing medium depth for all three stormwater planter types should be at least 18 inches. Growing media should be a uniform mixture of 70% sand (100% passing the 1-inch sieve and 5% passing the No. 200 sieve) and 30% topsoil with an average of 5% organic material, such as compost or peat, free of stones, roots and woody debris and animal waste.
- For infiltration and flow-through planters the drainage layer should have a minimum depth of 12 inches. Drainage layer should be clean sand with 100% passing the 1-inch sieve and 5% passing the No. 200 sieve.

SPECIFIC CONSIDERATIONS FOR THE DESIGN OF INFILTRATION PLANTERS

- The infiltration rate of the native soil should be a minimum of 2 inches per hour.
- A minimum infiltration depth of 3 feet should be provided between the bottom of the infiltration practice and any impermeable boundaries, such as the seasonal high groundwater level or rock.
- Infiltration planters should also be designed and constructed with no longitudinal or lateral slope.

Figure 5.53 Contained stormwater planters made of concrete



CONSTRUCTION

Figure 5.54 This flow-through planter collects runoff from the rooftop of a parking garage and is incorporated into the structure

- Materials suitable for planter wall construction include stone, concrete, brick, clay, plastic, wood, or other durable material (Figure 5.54).
- Treated wood may leach toxic chemicals and contaminate stormwater, and should not be used.
- Flow-through planter walls can be incorporated into a building foundation, with detailed specifications for planter waterproofing (Figure 5.55).



<http://www.lcrep.org/fieldguide/examples/containedpl>

Example

A simple example for sizing a stormwater planter using WQv is presented below. The ultimate size of a stormwater planter is a function of either the impervious area or the infiltration capacity of the media.

Determine the required surface area of a stormwater planter that will be installed to treat stormwater runoff from an impervious area of 3,000 square feet, given the depth of the soil medium is 1.5 feet.

Step 1: Calculate the WQv

$$WQv = (P) (Rv) (A) / 12$$

where:

$$P = 90\% \text{ rainfall number} = 0.9 \text{ in}$$

$$Rv = 0.05 + 0.009 (I) = 0.05 + 0.009(100) = 0.95$$

$$I = \text{percentage impervious area draining to planter} = 100\%$$

$$A = \text{Area draining to practice} = 3,000 \text{ ft}^2$$

$$WQv = (0.9) (0.95) (3000) / 12$$

$$WQv = 213.75 \text{ ft}^3$$

Step 2: Calculate required surface area:

$$A_f = WQv * (d_f) / [k * (h_f + d_f) (t_f)]$$

New York State Stormwater Management Design Manual

Chapter 5: Green Infrastructure Practices

Section 5.3 Green Infrastructure Techniques

where:

$$WQ_v = 213.75 \text{ ft}^3$$

$$d_f = \text{depth of soil medium} = 1.5 \text{ ft}$$

$$k = \text{hydraulic conductivity} = 4 \text{ ft/day}$$

$$h_f = \text{Average height of water above planter bed} = 0.5 \text{ ft}$$

$$t_f = \text{filter time} = 0.17 \text{ days}$$

$$A_f = (213.75)(1.5) / [(4)(0.5+1.5)(0.17)]$$

$$A_f = 235.75 \text{ ft}^2$$

Therefore, a 240 square-foot stormwater planter with a soil medium depth of 1.5 feet will be needed to treat stormwater from a 3,000 square foot area. The calculated WQ_v of 213.75 ft^3 is added to the Runoff Reduction Volume for the site (if the site soils are suitable for infiltration). If the planter is designed as a flow-through planter on C soils, then 96 ft^3 (45% of the WQ_v for the area draining to the planter) is added to the Runoff Reduction Volume. 64 ft^3 (30% of the WQ_v) is added towards the Runoff Reduction Volume for a flow through planter on D soils.

Environmental/Landscaping

Vegetation selected for stormwater planters should be relatively self-sustaining and adaptable. Native plant species are recommended, and fertilizer and pesticide use should be avoided whenever possible. Tree planting is encouraged in and adjacent to infiltration and flow-through planters for the infiltration, habitat and interception benefits they can provide.

Maintenance

A regular and thorough inspection regime is vital to the proper and efficient function of stormwater planters. Debris and trash removal should be conducted on a weekly or monthly basis, depending on likelihood of accumulation. Following construction, planters should be inspected after each storm event greater than 0.5 inches, and at least twice in the first six months. Subsequently, inspections should be conducted seasonally and after storm events equal to or greater than the 1-year storm event. Routine maintenance activities include pruning and replacing dead or dying vegetation, plant thinning, and erosion repair. Since stormwater planters are not typically preceded by pre-treatment practices, the soil surface should be inspected for evidence of sediment build-up from the connected impervious surface and for surface ponding. Attention should be paid to additional seasonal maintenance needs as well as the first growing season.

New York State Stormwater Management Design Manual

Chapter 5: Green Infrastructure Practices

Section 5.3 Green Infrastructure Techniques

References/Further Resources

City of Portland, Oregon. Revised September 2004. Portland Stormwater Management Manual.
<http://www.portlandonline.com/bes/index.cfm?c=35122>

Flinker, P., 2005. Rhode Island Urban Environmental Design Manual “Green Rooftop Systems” Narrative.
Sustainable Watersheds Office Rhode Island Department of Environmental Management.
<http://www.dem.ri.gov/programs/bpoladm/suswshed/pubs.htm>

Low Impact Development Center, Inc. (LID). Accessed 2005. http://www.lid-stormwater.net/treebox/treeboxfilter_cost.htm

New York Floral Association: New York Floral Atlas website: <http://www.newyork.plantatlas.usf.edu/>

Portland Bureau of Environmental Services (PBES). December 2004. Liberty Centre Parking Garage.
<http://www.portlandonline.com/bes/index.cfm?c=38135>

USDA, Natural Resources Conservation Service PLANTS database: <http://plants.usda.gov/>

5.3.10 Rain Barrels and Cisterns

Description: Rain Barrels and Cisterns capture and store stormwater runoff to be used later for lawn and landscaping irrigation or filtered and used for nonpotable water activities such as car washing or filling swimming pools and other uses that have a routine demand for water when in service. Rain Barrels and Cisterns may be constructed of any water-retaining material; their size varies from hundreds of gallons for residential uses to tens of thousands of gallons for commercial and/or industrial uses. The storage systems may be located either above or below ground and may be constructed of on-site material or pre-manufactured. Rain barrels are rooftop catchment storage systems typically utilized in residential settings while cisterns are large-scale rain barrels used in commercial and industrial settings. The basic components of a rain barrel and cistern include: a watertight storage container, secure cover, a debris/mosquito screen, a coarse inlet filter with clean-out valve, an overflow pipe, a manhole or access hatch, a drain for cleaning, an extraction system (tap or pump). Additional features might include a water level indicator, a sediment trap or a connector pipe to an additional tank for extra storage volume. The storage containers are usually placed on riser blocks or a gravel pad to aid in gravity drainage of collected runoff and to prevent the accumulation of overflow water around the system.

Recommended Application of the Practice

Rain Barrels and Cisterns may be used in most areas (residential, commercial, and industrial; see Figure 5.56) due to their minimal site constraints relative to other stormwater management practices. They may be applied to manage almost every land use type from very dense urban to more rural residential areas. Storage volumes of the rain barrels and cisterns are directly proportional to their contributing rooftop drainage areas and the intended end use and demand for the collected rainwater.

Benefits

Rain Barrels and Cisterns provide many stormwater management benefits, including:

- Reduced stormwater runoff entering the drainage system, not only reduced volumes, but also delayed and/or reduced peak runoff flow rates during the water quality storm event.
- Reduced transport of pollutants associated with atmospheric deposition on rooftops into receiving waters, especially heavy metals and other airborne pollutants (USEPA, 2005).
- Reduced water consumption for nonpotable uses, which ultimately reduces the demand on municipal water systems. Water from rain barrels and cisterns, if managed correctly, may be used to water lawns and landscaping , wash automobiles, and top off pools (MEDP, 2009)

New York State Stormwater Management Design Manual

Chapter 5: Green Infrastructure Practices

Section 5.3 Green Infrastructure Techniques

- Use as retrofits in urban redevelopment scenarios to reduce runoff volumes in areas where there is a high percentage of impervious cover, soils are compacted, groundwater levels are high, and/or hot-spot conditions exist that preclude infiltration of runoff.

Figure 5.55 Cisterns can be designed for smaller residential uses (left) or for larger commercial and industrial business operations (right).



Feasibility/Limitations

The biggest limitation to the installation and use of rain barrels and cisterns for the capture and reuse of stormwater is the need for active management/maintenance and initial capital cost. Generally, the ease and efficiency of municipal water supply systems and the low cost of potable water prevent people from implementing on-site rainwater collection and reuse systems. Specific limitations include:

- Periodic maintenance and cleaning to ensure effective storage of stormwater while reducing the growth of algae and limiting the potential for mosquito breeding.
- A supplementary water source may be needed if captured water does not fulfill the intended water demand. Alternatively if captured water is not used as anticipated or excessive rainfall occurs, the extra water collected must be managed to prevent overtopping and erosion of areas below the rain barrel or cistern.
- To achieve significant community wide acceptance, an active community education program and/or a high profile demonstration project at a public facility will likely be necessary.
- Improper or infrequent use of the collection system by the property owner, such as the rain barrel never being emptied between storm events to allow for subsequent capture of rooftop runoff may result in unintended discharges.

New York State Stormwater Management Design Manual

Chapter 5: Green Infrastructure Practices

Section 5.3 Green Infrastructure Techniques

- In cold climates specific design or maintenance strategies will need to be considered to prevent freezing such as providing insulation or disconnecting the system during the winter months.
- Rooftop harvested rainwater has the potential for contamination and should not be used for drinking or watering food plants. Pipes or storage units should be clearly marked. Local health and plumbing codes need to be consulted.
- The conveyance system should keep reused stormwater or grey water from other potable water piping systems. Do not connect to domestic or commercial potable water systems.

Sizing and Design Criteria

The cistern/rain barrel sizing is based on the water demand for the intended use. The amount of water available for reuse is a function of the impervious area that drains to the device. Runoff reduction credit is applied if the water demand and system sizing is equal to or greater than the WQv. A supplementary water source may be needed to augment the cistern/rain barrel system. The basic equation for sizing a system based on the contributing area is as follows:

$$\text{Vol} = \text{WQv} * 7.5 \text{ gals/ ft}^3$$

where:

Vol = Volume of system [gallons]

WQv = Water Quality Volume [ft³], as defined in Chapter 4 of the NYS Stormwater Design Manual

7.5 = Conversion factor [gallons per ft³]

Siting the System

A rain barrel may be located beneath a single downspout or multiple rain barrels may be located such that they collect stormwater from several rooftop sources. Due to the size of rooftops and the amount of contributing impervious area, increased runoff volume and peak discharge rates for commercial and industrial sites may require large capacity cisterns. Rain barrels and Cisterns designed to capture small, frequent storm events must be either actively or passively drained to provide storage for subsequent storm events or located in an area where overflow runoff can be conveyed to a suitable area such as a buffer area, open yard, grass swale or a rain garden. See Figure 5.57.

CLIMATE

Climate is an important consideration and capture/reuse systems should be designed to account for the potential for freezing. In cold climates where cisterns are designed for use throughout the year, they will need to be protected from freezing. These systems may need to be located indoors or underground below

Figure 5. 56 Cross section of a residential rain barrel system with overflow

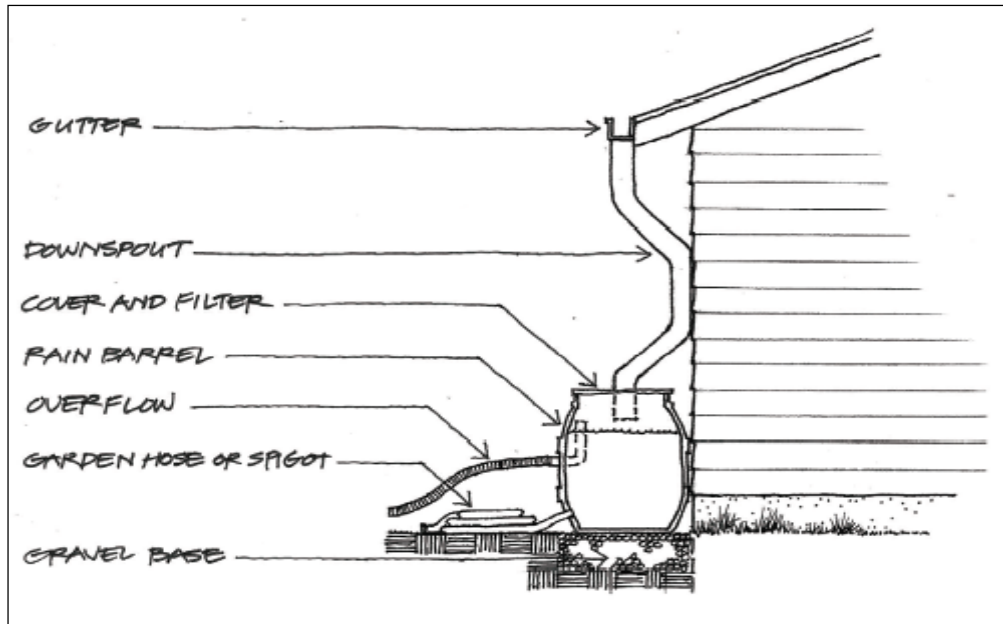

http://buildgreen.ufl.edu/Fact_%20sheet_Cisterns_Rain_Barrels.p

the frost line if freezing conditions are expected. Cisterns placed on the ground require extra insulation on the exposed surfaces (Stensrod, *et al.*, 1989). For cisterns placed on rock, the bottom surface will also need to be insulated. For underground systems it may be cost-prohibitive to place the cistern below the freezing depth, so alternatively, insulation may be placed below the surface and above the underground cistern to prevent freezing. Other methods to prevent freezing include lining the intake pipe and cistern with heat tape and closing the overflow valve (Stensrod, *et al.*, 1989). Water levels in the cistern must be lowered at the beginning of winter to prevent possible winter ice damage and provide the needed storage in the cistern for capturing rooftop runoff from the spring snow melt.

The year round use of rain barrels in cold climates is not recommended since these containers may burst due to ice formation and freezing temperatures (Metropolitan Council, 2001). It is recommended that the rain barrels be disconnected from the roof gutters and placed indoors during the winter months. Downspout piping must be reconnected and directed to a grassy area away from the structure to prevent winter snowmelt from damaging building foundations.

Design Example

A simple example for sizing cisterns using WQv is presented in Table 5.13.

New York State Stormwater Management Design Manual

Chapter 5: Green Infrastructure Practices

Section 5.3 Green Infrastructure Techniques

Though at a minimum the WQv must be stored in the rain barrel or cistern to earn runoff reduction credit for this practice, the amount of storage provided by the system determines the volume of water available for reuse. As a rule of thumb, a 1,000 S.F. roof will generate 625 gallons of rain during a 1” storm event.

Table 5.13 Simple Cistern Sizing Example

Given a 3,000 square foot impervious surface area draining to a cistern, calculate the water quality volume and required storage volume within the system.

Step 1: Calculate water quality volume using the following equation:

$$WQv = \frac{(P)(Rv)A}{12}$$

where:

P = 90% rainfall number = 0.9 in

Rv = 0.05+0.009 (I) = 0.05+0.009(100) = 0.95

I = the percentage of impervious area draining to site = 100%

A = the Area Draining to Practice = 3,000 ft²

$$WQv = \frac{(0.90)(0.95)3,000}{12} \qquad WQv = 213.75 \text{ ft}^3$$

Step 2: Calculate storage volume using equation above: Vol = (WQv) (7.5 gals/ ft³)

Vol = WQv x 7.5 gals/ ft³ (1603 gal)

Therefore, to treat the water quality volume for the area draining to the practice, a 1,650-gallon cistern is required. This equation must be utilized for the contributing drainage area to each downspout for the adequate sizing of a rain barrel or cistern. The calculated WQv is applied towards the Runoff Reduction Volume

Required Elements

A minimum amount of information must be provided in the SWPPP to obtain runoff reduction credit if using this practice. On a site map and summary table:

- Identify the area of rooftop proposed for capture in a rain barrel or cistern collection system
- Provide calculations verifying the WQv sizing criteria from Table 1 are satisfied by the proposal
- Identify the material specifications or manufacturer/model for the selected rain barrel or cistern
- Provide a plan and profile view of the proposed rain barrel or cistern layout around the building

New York State Stormwater Management Design Manual

Chapter 5: Green Infrastructure Practices

Section 5.3 Green Infrastructure Techniques

- Identify installation techniques to ensure proper placement and to allow for runoff overflows
- Identify maintenance requirements and educational brochures for continued operation of the practices.
- Provide a water budget analysis.
- Identify how water will be used to ensure that the system will be available for subsequent runoff events.

Figure 5.57 Cisterns can be incorporated into the overall landscaping of the site.



Environmental/Landscaping

An effort should be made to meet property owners' preferences in providing attractive above-ground rain barrels and cisterns. The likelihood of continued use of these practices is increased if they are an attractive part of the exterior setting (Figure 5.58). Landscaping or fencing may be used to shade rain barrels and cisterns to reduce algae growth and to provide visual screening, if desired.

Maintenance

Privately owned practices shall have a maintenance plan and shall be protected by easement, deed restriction, ordinance, or other legal measures preventing its neglect, adverse alteration, and removal. Cisterns are considered to be a permanent feature of the design and should be labeled as such to prevent removal. Maintenance requirements for rain barrels and cisterns vary depending on the end use of the collected water. Depending on the design and use of the system, winterization maintenance may also be necessary. Generally, routine system inspections should be conducted to ensure the system is available for storage of subsequent rain events and the following components inspected and either repaired or replaced as needed:

- Inspect roof catchments to ensure that minimal amounts of particulate matter or other contaminants are entering the gutter and downspout.
- Inspect the gutters and downspouts to check for leaks or obstructions.
- Inspect diverts, cleanout plugs, screens, covers, and overflow pipes and repair or replace as needed.
- Inspect inflow and outflow pipes as well as any accessories, such as connectors to adjacent storage containers or a water pump.

New York State Stormwater Management Design Manual

Chapter 5: Green Infrastructure Practices

Section 5.3 Green Infrastructure Techniques

References/Further Resources

Kessner, K., 2000. How to Build a Rainwater Catchment Cistern. *The March Hare*, Summer 2000, Issue 25, <http://www.dancingrabbit.org/building/cistern.html>

Low Impact Development Center, Inc. (LID). Accessed 2009. http://www.lid-stormwater.net/raincist_specs.htm

Maryland Environmental Design Program (MEDP). Accessed 2009. <http://www.dnr.state.md.us/ed/rainbarrel.html>

Metropolitan Council, 2001. Minnesota Urban Small Sites Best Management Practices (BMP) Manual. http://www.metrocouncil.org/environment/watershed/BMP/CH3_STInfilOnLot.pdf

Stensrod, O. and Gosback, J. September 1978. Translated May 1989, Johansen, J. and Seifert R.. *Water Cistern Construction for Small Houses*. Alaska Building Research Series, HCM-01557.

Texas Water Development Board (TWDB). 2005. *The Texas Manual on Rainwater Harvesting 3rd Edition*. http://www.twdb.state.tx.us/publications/reports/RainwaterHarvestingManual_3rdedition.pdf

The Urban Garden Center (UGC) <http://www.urbangardencenter.com/products/rainbarrel/index.html>

United States Environmental Protection Agency (USEPA). 2005. *National Management Measures to Control Nonpoint Source Pollution from Urban Areas*, EPA Document - EPA-841-B-05-004.

5.3.11 Porous Pavement

Description: Permeable paving is a broadly defined group of pervious types of pavements used for roads, parking, sidewalks, and plaza surfaces. Permeable paving provides an alternative to conventional asphalt and concrete surfaces and are designed to convey rainfall through the surface into an underlying reservoir where it can infiltrate, thereby reducing stormwater runoff from a site. In addition, permeable paving reduces impacts of impervious cover by augmenting the recharge of groundwater through infiltration, and providing some pollutant uptake in the underlying soils. Due to the potential high risk of clogging the pavement voids and the underlying soils, permeable paving should be limited in its use and should require strict adherence to manufacturer's specifications for installation and maintenance.

Permeable paving has three main design components: surface, storage, and outflow. The surface types of paving can be broken into two basic design variations: porous pavement and permeable pavers. *Porous pavement* is a permeable asphalt or concrete surface that allows stormwater to quickly infiltrate to an underlying reservoir. Porous pavement looks similar to conventional pavement, but is formulated with larger aggregate and less fine particles, which leaves void spaces for infiltration. *Permeable pavers* include reinforced turf, interlocking concrete modules, and brick pavers (Figure 5.59). Often, these designs do not have an underground stone reservoir, but can provide some infiltration and surface detention of stormwater to reduce runoff velocities.

Figure 5.58 Asphalt, Permeable Pavers, Porous Concrete, Albany, NY



The storage component includes coarse aggregate laid beneath porous surfaces, designed to store stormwater prior to infiltration into soils as well as distributing mechanical loads. The aggregate is wrapped in a non-woven geotextile to prevent migration of soil into the storage bed and resultant clogging. The storage bed also has a choker course of smaller aggregate to separate the storage bed from the surface course. The storage bed can be designed to manage runoff from areas other than the porous surface above it, or can be designed with additional storage to meet the Channel Protection Volume.

The outflow results from runoff percolation directly into the underlying soil, which recharges groundwater and removes stormwater pollutants. Systems designed for runoff reduction must be designed according to the capacity of the underlying soil and required elements of infiltration systems. Runoff can also be drained

New York State Stormwater Management Design Manual

Chapter 5: Green Infrastructure Practices

Section 5.3 Green Infrastructure Techniques

out of the stone reservoir through an underdrain system connected to the storm drain system. A perforated pipe system can convey water from the storage bed to an outflow structure. The outflow structure can be designed to provide Channel Protection.

Recommended Application of Practice

Permeable paving provides the structural support of conventional pavement, while reducing stormwater runoff by draining directly into the underlying base and soils. It can be used to treat low traffic roads (i.e., a few houses or a small cul-de-sac), single-family residential driveways, overflow parking areas, sidewalks, plazas, tennis or basketball courts, and courtyard areas. Good opportunities can be found in larger parking lots, spillover parking areas, schools, municipal facilities, and urban hardscapes. Permeable paving is intended to capture, infiltrate and/or manage small frequent rainfall events (i.e. channel protection). The practice can be applied in both redevelopment and new development scenarios.

Benefits

Permeable paving can have many benefits when applied to redevelopment and infill projects in urban centers. The most notable benefits include:

- Groundwater recharge augmentation
- Runoff reduction to ease capacity constraints in storm drain networks
- Effective pollutant treatment for solids, metals, nutrients, and hydrocarbons (see pollutant removal performance, Table 5.14)
- Aesthetic improvement to otherwise hard urban surfaces (e.g., interlocking permeable pavers, lattice pavers, Figure 5.60)

Two long-term monitoring studies of porous pavement systems conducted in Rockville, MD, and Prince William, VA, indicated high removal efficiencies for sediments and nutrients (see Table 5.14). The Rockville study also reported high removals for zinc (99%), lead (98%), and chemical oxygen demand (82%) (Schueler, 1987). The University of New Hampshire Stormwater Center found typical performance efficiencies for TSS, total Zinc, and total phosphorus to exceed 95%, 97%, and 42% respectively. (UNCSC, 2009)

Figure 5.59 Walkway with permeable pavers -Scenic Hudson Park, Cold Spring, NY



(NYSDEC. 2009)

Table 5.14 Estimated Pollutant Removal Performance of Porous Pavement (Porous Asphalt) (EPA, 1999)	
Pollutant Parameter	% Removal
Total Phosphorus	65
Total Nitrogen	80 – 85
Total Suspended Solids	82 – 95

Feasibility/Limitations

Major limitations to this practice are suitability of the site grades, subsoils, drainage characteristics, and groundwater conditions. Proper site selection is an important criterion in reducing the failure rate of this practice. Areas with high amounts of sediment-laden runoff and high traffic volume are likely causes of system failure. High volume parking lots, particularly parking drive aisles, high dust areas, and areas with heavy equipment traffic, are not recommended for this practice. Ownership and maintenance responsibility should also be considered in determining the potential for success.

Soil: It is important to confirm that local soils are permeable and can support adequate infiltration, since past grading, filling, disturbance, and compaction can greatly alter the original infiltration qualities. Sandy and silty soils are critical to successful application of permeable pavements. The HSG should be A, B or C.

Cold Climate Considerations: Permeable paving practices can be used effectively in cold-climate areas, but should not be used where sand or other materials are applied for winter traction since they quickly clog the pavement. Care should be taken when applying salt to permeable pavement, since chlorides can easily migrate into the groundwater. Care should also be taken to select a surface material that can tolerate undulations from frost movements, or to protect pavements from frost damage (Ferguson, 2005).

Winter maintenance is usually less maintenance intensive than that required by standard pavement. By its very nature, a porous pavement system with subsurface aggregate bed has better snow and ice melting characteristics than standard pavement. Once snow and ice melt, they flow through the porous pavement rather than re-freezing. Therefore, ice and light snow accumulation are generally not as problematic. However, snow will accumulate during heavier storms. Abrasives such as sand or cinders shall not be applied on or adjacent to the porous pavement. Snow plowing is acceptable, provided it is done carefully (i.e. by setting the blade about one inch higher than usual) (PA Design Manual).

New York State Stormwater Management Design Manual

Chapter 5: Green Infrastructure Practices

Section 5.3 Green Infrastructure Techniques

For design variation in cold climate frost depth consult UNHSC design specification (65% frost depth from the top of pavement to the native ground). (UNHSC, 2009)

Land Use: Like any stormwater infiltration practice, there is a possibility of groundwater contamination. Therefore, permeable paving infiltration systems shall not be used to treat stormwater hotspots, areas where land uses or activities have the potential to generate highly contaminated runoff. These areas may include, but are not limited to: commercial nurseries, auto recycling and repair facilities, fleet washing facilities, fueling stations, high-use commercial parking lots, and marinas. Additionally, certain types of permeable pavers, such as block, grid pavers, and gravel, are not ideal for areas that require handicap accessibility.

Siting: Permeable pavements shall not be used in areas where there are risks for foundation damage, basement flooding, interference with subsurface sewage disposal systems, or detrimental impacts to other underground structures.

Setbacks: The bottom of the storage reservoir shall be located at least 3 feet above the seasonally high groundwater table. Permeable pavement systems shall be separated by at least 100 horizontal feet away from drinking water wells and 25 feet down gradient from structures and septic systems.

Hotspot Runoff: Permeable pavements shall not be used to treat hotspots that generate higher concentrations of hydrocarbons, trace metals, or toxicants than are found in typical stormwater runoff and may contaminate groundwater.

Sizing and Design Criteria

These standards are intended to address the stormwater management aspect of porous pavement applications. They do not cover the structural integrity or traffic load design requirements. For such design detail please consult the references listed at the end of this section. The following lists the required elements of the design for runoff reduction, treatment, flood control, and maintenance.

Required Elements

SITE EVALUATION

- The area proposed for a porous pavement system must be fully evaluated, addressing all the factors including but not limited to infiltration, geotechnical, hotspot conditions, topography, and setbacks.

DRAINAGE

New York State Stormwater Management Design Manual

Chapter 5: Green Infrastructure Practices

Section 5.3 Green Infrastructure Techniques

- Runoff shall flow through and exit permeable pavements in a safe and non-erosive manner.
- Permeable pavements should be designed off-line whenever possible. Runoff from adjacent areas should be diverted to a stable conveyance system. If bypassing these areas is impractical, then runoff should sheetflow onto permeable pavements.
- The contributing drainage area should be limited to small adjacent impervious areas (i.e. non-traffic side walk and rooftops)
- When designing porous pavement systems for treatment of adjacent areas, the subbase storage must be designed with extra capacity by adding to the filter course. Adjacent impervious surfaces can also be graded so that the runoff from the impervious area sheet flows over the porous pavement or may be connected to the underlying storage bed. Pretreatment of impervious areas connected directly to the bed is required to prevent particulate materials clogging the subbase of the porous pavement system.
- Systems shall be designed to ensure that the water surface elevations for the 10-year, 24-hour design storm do not rise into the pavement to prevent freeze/thaw damage. Depending on the intended use of the system, a perforated pipe system (set at an elevation above the design storm that is intended for infiltration) can convey water from the storage bed to an outflow structure. The storage bed and outflow structure can be designed to control the Channel Protection and/or Flood Control requirement. Inlets can be used to provide positive overflow for impervious areas that are connected to the underlying storage bed, if additional rate control is not necessary.
- As a back-up measure in case of clogging, permeable paving practices can be designed with a perimeter trench to provide some overflow treatment should the surface clog. Pavement systems should include an alternate mode, such as a trench for runoff to enter the subbase reservoir. In curbless designs, this could consist of a 2-foot wide stone edge drain. Raised inlets may be required in curbed applications (from MD Manual).

TREATMENT

- Applications that are intended for infiltration shall be designed as infiltration practices using the design methods for infiltration trenches outlined in Chapter 6 of this Manual.
- Applications on poor soil, karst geology, or brown fields that require a liner will not provide the full runoff reduction value. However, this type of practice may be designed as a filtering system, t applied as a storage detention system for channel protection.

SOILS

- The underlying parent soils should have a minimum infiltration rate of 0.5 inches per hour. Soil testing is required as set forth in Appendix D of this Design Manual. To maintain effective pollutant removal in the underlying soils, organic matter content in the subsoils is important.

SLOPES

- Runoff should sheetflow across permeable pavement. Slopes across the surface and bottom of the stone reservoir should not exceed 5 percent to prevent ponding of water on the surface and within

New York State Stormwater Management Design Manual

Chapter 5: Green Infrastructure Practices

Section 5.3 Green Infrastructure Techniques

the subbase. Ideally it should be completely flat so that the infiltrated runoff will be able to infiltrate through the entire surface. A terraced system may be used on slopes. Perforated pipes may be used to distribute runoff through the reservoir evenly.

STRUCTURE

- All permeable pavement shall be capable of bearing the anticipated vehicle and traffic loads. Pavement systems conforming to the specifications found in this manual should be structurally stable for typical (e.g. light duty) applications. (MD Design Manual)
- Subbase aggregates shall be clean and free of fines. All aggregates within infiltration storage beds shall meet the following criteria:
 - Maximum wash loss of 0.5%
 - Minimum Durability Index of 35
 - Maximum abrasion of 10% for 100 revolutions and maximum of 50% for 500 revolutions
- Depth of the stone base can be adjusted depending on the management objectives, total drainage area, traffic load, and in-situ soil characteristics.

Construction Guidelines

- Installation procedures are vital to the success of pervious pavement projects, particularly pervious asphalt and concrete pavement mixes. The subgrade cannot be overly compacted with the inclusion of fine particulates or the void ratio critical to providing storage for large storm events will be lost. Weather conditions at the time of installation can affect the final product. Extremely high or low temperatures should be avoided during construction of pervious asphalt and concrete pavements.
- Areas for porous pavement systems shall be clearly marked before any site work begins to avoid soil disturbance and compaction during construction.
- Pervious pavement and other infiltration practices should be installed toward the end of the construction period. Upstream construction shall be completed and stabilized before connection to porous pavement system. A dense and vigorous vegetative cover shall be established over any contributing pervious drainage areas before runoff can be accepted into the facility.
- Subsurface area should be excavated to proposed depth. Existing subgrade shall NOT be compacted or subject to excessive construction equipment prior to placement of geotextile and stone bed. Where erosion of subgrade has caused accumulation of fine materials and/or surface ponding, this material shall be removed with light equipment and the underlying soils scarified to a minimum depth of 6 inches with a York rake or equivalent and light tractor.
- The bottom of the infiltration bed shall be at a level grade.
- Place geotextile and recharge bed aggregate immediately after approval of subgrade preparation to prevent accumulation of debris or sediment. Prevent runoff and sediment from entering the storage bed during the placement of the geotextile and aggregate bed.

New York State Stormwater Management Design Manual

Chapter 5: Green Infrastructure Practices

Section 5.3 Green Infrastructure Techniques

- Place geotextile in accordance with manufacturer's standards and recommendations. Adjacent strips of filter fabric shall overlap a minimum of 16 inches. Fabric shall be secured at least 4 feet outside of bed. This edge strip should remain in place until all bare soils contiguous to beds are stabilized and vegetated.
- As the site is fully stabilized, excess geotextile can be cut back to the edge of the bed.

Install aggregate course in lifts of 6-8 inches. Keep equipment movement over storage bed subgrades to a minimum. Install aggregate to grades indicated on the drawings. The materials of construction should be in accordance with specifications provided in Table 5.15. The engineer is responsible for developing detailed specifications and Quality Assurance/Quality Control measures for individual design projects.

Sizing

The basic equation for sizing the required porous surface area is as follows:

$$A_p = V_w / (n \times d_t)$$

where:

A_p = the required porous pavement surface area [square feet]

V_w = the design volume [cubic feet]

n = porosity of gravel bed/reservoir (assume 0.4)

d_t = depth of gravel bed/reservoir (maximum of four feet, and separated by at least three feet from seasonally high groundwater) [feet]

Design volume V_w may include WQ_v and CP_v from contributing area. An example calculation for porous pavement is provided in Table 5.16.

New York State Stormwater Management Design Manual

Chapter 5: Green Infrastructure Practices

Section 5.3 Green Infrastructure Techniques

Table 5.15 Material Specifications for Porous Pavement

Material	Specification			Notes
	Porous Asphalt	Porous Concrete	Permeable Paver	
Pavement	3"-7" Bituminous mix ½" Nominal Maximum Aggregate Size ≥18% Air Voids (50 gyrations) Draindown ≤0.3%	4"-8" Portland Cement Type I or II (ASTM C 150), No. 8 (ASTM 33), Agg.:Cement Ratio 4:1 to 4.5:1 Water/Cement Ratio 0.28-0.35	Varied shapes and sizes, 8%-10% surface opening, manufacturer specification, flow rate 5 in/hr or no less than 10% void	
Choker course	4"-8" depth AASHTO No. 57	None	2" AASHTO No. 8 stone over 4" of No. 57	Should be double-washed and clean and free of all fines
Filter Layer	8"-12" No. 2 stone	No. 2 stone	No. 2 stone	Depth based on structural, storage, and hydraulic requirements. Double-washed, clean, free of fines
Drainage Layer	The underlying native soils should be separated from the filter layer by a 3 inch layer pea gravel over a reservoir course with at min. a 4 inch layer of choker stone (AASHTO No. 3 or 5). For design variation of thickness, storage, underdrain measure, and cold climate frost depth consult UNHSC design specification for reservoir course (UNHSC, 2009)			Sand should be placed between stone reservoir and choker stone, on top of underlying native soils.
Underdrain	Where system as a whole needs to meet storage/release criteria and overflow piping to minimize chance of clogging. 4"-6" perforated PVC (AASHTO M 252) pipe, with 3/8-inch perforations at 6 inches on center, solid connectors; each pipe at minimum 0.5% slope, 20 feet apart. Extend cleanout pipes to the surface with vented caps at Ts & Ys.			
Filter Fabric (optional)	Needled, non-woven, polypropylene geotextile with grab tensile strength greater or equal to 120 lbs (ASTM D4632), Mullen Burst strength greater or equal to 225 lbs/sq in (ASTM D3786), Flow rate greater than 125 gpm/sf (ASTM D4491) and Apparent Opening Size US # 70 or # 80 sieve (ASTM D4751). Geotextile AOS selection is based on the percent passing the No. 200 sieve in "A" Soil subgrade, using FHWA or AASHTO selection criteria			
Impermeable Liner	Minimum thirty mil PVC geomembrane liner covered by 8 to 12 oz/yd ² non-woven geotextile. Required only for Karst region and brown field applications.			
Observation Well	Perforated 4-6 inch vertical PVC pipe (AASHTO M 252), with lockable cap installed flush with the surface with surface cap.			

New York State Stormwater Management Design Manual

Chapter 5: Green Infrastructure Practices

Section 5.3 Green Infrastructure Techniques

Table 5.16 Porous Pavement Simple Sizing Example

A porous pavement area is being designed to treat a 20,000 square foot drainage area. Based on the water quality volume required to treat this area, an assumed gravel bed/reservoir porosity of 0.4, and a gravel bed/reservoir depth of one foot, the following calculations were completed to determine the required porous pavement surface area.

Step 1: Calculate the WQv

$$WQv = \frac{(P)(Rv)A}{12}$$

where:

P = 90% rainfall number = 0.9 in

Rv = 0.05+0.009 (I) = 0.05+0.009(100) = 0.95

I = percentage impervious area draining to site = 100%

A = Area Draining to Practice (i.e., treatment area) = 20,000 ft²

$$WQv = \frac{(0.90)(0.95)20,000}{12} \quad WQv = 1,425 \text{ ft}^3$$

Step 2: Calculate the available storage volume in the storage reservoir:

$$\text{Storage Volume} = A_p * n * d_t$$

where:

n = assumed porosity = 0.4

d_t = gravel bed/reservoir depth = 1 ft

Storage Volume = 20,000 sf * 0.4 * 1 ft

Storage Volume = 8,000 cf

Which is much higher than required for the 90th percentile storm event (1425 cf).

The storage reservoir could hold up to 5” of direct rainfall onto the pavement

Step 3: Determine storage available for treatment of additional impervious area (limited to rooftops, sidewalks and other non-vehicular surfaces), CPv or higher storms:

$$\text{Available Storage} = \text{Reservoir Storage Volume} - WQv$$

$$\text{Available Storage} = 8000 \text{ cf} - 1425 \text{ cf} = 6575 \text{ cf}$$

$$\text{Additional area} = \text{Volume (cf)} / P(\text{inches}) / Rv * 12 \text{ in/ft}$$

$$\text{Additional Impervious Area} = 6575 \text{ cf} / 0.9 \text{ inches} / 0.95 * 12 \text{ in/ft} = 92,280 \text{ sf}$$

New York State Stormwater Management Design Manual

Chapter 5: Green Infrastructure Practices

Section 5.3 Green Infrastructure Techniques

Step 4: Determine height WQv would reach within the storage chamber:

$d = 1425 \text{ cf} / 20,000 \text{ sf} / 0.4 = 2 \text{ inches}$ (10 inches is available for storage of higher storms.

In order to receive runoff reduction credit, the overflow device must be set at least 2 inches above the bottom.

Therefore, the 20,000 square feet of porous pavement with a 1 foot deep storage reservoir can provide treatment and storage for about 4.5" rainfall onto its' surface or runoff from immediate adjacent areas.

New York State Stormwater Management Design Manual

Chapter 5: Green Infrastructure Practices

Section 5.3 Green Infrastructure Techniques

Permeable paver (e.g., interlocking block, concrete grid pavers, etc.) areas that do not have a storage reservoir are most effective when designed to accommodate small rainfall depths (e.g., less than 1 inch) that fall directly on the paver areas. They are less effective and more prone to clogging when used to also receive runoff from other areas. Unless underlying soils are extremely permeable, larger storms will either sheet flow off the site, or if not graded properly, will pond on the site. To address these concerns, the following restrictions are placed on the use of permeable pavers installed without an underlying storage reservoir:

- The area of application is not subject to traffic (allowed for patios, walkways, small driveways)
- The area of application must overlay highly permeable soils (A or B).
- No additional area drains onto the paver area.

Provided that these criteria are met, the application area shall be treated as pervious. However no storage credit is applied. Pavers with a gravel reservoir are treated the same as porous concrete and asphalt (size the reservoir to store the WQv).

Environmental/Landscaping Considerations

Stringent sediment controls are required during the construction stage, and all adjacent land areas should be stabilized prior to installing permeable paving practices. Where feasible, a grass filter strip is recommended to pre-treat adjacent land areas that drain to porous pavement areas.

Maintenance

- Permeable pavements are highly susceptible to clogging and subject to owner neglect. Individual owners need to be educated to ensure that proper maintenance and winter operation activities will allow the system to function properly.
- The type of permeable paving and the location of the site dictate the required maintenance level and failure rate. Concrete grid pavers and plastic modular blocks require less maintenance because they are not clogged by sediment as easily as porous asphalt and concrete. Areas that receive high volumes of sediment will require frequent maintenance activities, and areas that experience high volumes of vehicular traffic will clog more readily due to soil compaction. Typical maintenance activities for permeable paving are summarized below (Table 5.17).

New York State Stormwater Management Design Manual

Chapter 5: Green Infrastructure Practices

Section 5.3 Green Infrastructure Techniques

Table 5.17 Typical Maintenance Activities for Permeable Paving (WMI, 1997)

Activity	Schedule
Ensure that paving area is clean of debris	Monthly
Ensure that paving dewaterers between storms	Monthly and after storms >0.5 in.
Ensure that the area is clean of sediments	Monthly
Mow upland and adjacent areas, and seed bare areas	As needed
Vacuum sweep frequently to keep surface free of sediments	Typically 3 to 4 times a year
Inspect the surface for deterioration or spalling	Annual

When maintenance of permeable paving areas is required, the cause of the maintenance should be understood prior to commencing repairs so unnecessary difficulties and recurring costs can be avoided (Ferguson, 2005). Generally, routine vacuum sweeping and high-pressure washing (with proper disposal of removed material and washwater) can maintain infiltration rates when clogged or crusted material is removed. Signs can also be posted visibly within a permeable paving area to prevent such activities as resurfacing, the use of abrasives, and to restrict truck parking.

References/Further Resources

Ferguson, B. 2005. *Porous Pavements*. CRC Press.

Low Impact Development Center, Inc. (LID) <http://www.lid-stormwater.net/intro/sitemap.htm#permpavers>

Schueler, T. 1987. *Controlling Urban Runoff: A Practical manual for Planning and Designing Urban BMPs*. Metropolitan Washington Council of Governments. Washington, DC

University of New Hampshire Stormwater Center, UNCSC Design Specifications for Porous Asphalt Pavement and Infiltration Beds. Oct. 2009.

United States Environmental Protection Agency (EPA), "Storm Water Technology Fact Sheet, Porous Pavement." September 1999.

Watershed Management Institute (WMI). 1997. *Operation, Maintenance, and Management of Stormwater Management Systems*. Prepared for: US EPA Office of Water. Washington, DC.

Chapter 6: Performance Criteria

This chapter outlines performance criteria for five groups of structural stormwater management practices (SMPs) to meet water quality treatment goals. These include ponds, wetlands, infiltration practices, filtering systems and open channels. Each set of SMP performance criteria, in turn, is based on six performance goals:

Feasibility

Identify site considerations that may restrict the use of a practice.

Conveyance

Convey runoff to the practice in a manner that is safe, minimizes erosion and disruption to natural channels, and promotes filtering and infiltration.

Pretreatment

Trap coarse elements before they enter the facility, thus reducing the maintenance burden and ensuring a long-lived practice.

Treatment Geometry

Provide water quality treatment, through design elements that provide the maximum pollutant removal as water flows through the practice.

Environmental/Landscaping

Reduce secondary environmental impacts of facilities through features that minimize disturbance of natural stream systems and comply with environmental regulations. Provide landscaping that enhances the pollutant removal and aesthetic value of the practice.

Maintenance

Maintain the long-term performance of the practice through regular maintenance activities, and through design elements that ease the maintenance burden.

New York State Stormwater Management Design Manual

Chapter 6: Performance Criteria

Section 6.1 Stormwater Ponds

Cold climate regions of New York State may present special design considerations. Each section includes a summary of possible design modifications that address the primary concerns associated with the use of that SMP in cold climates. A more detailed discussion of cold climate modifications can be found in the publication *Stormwater BMP Design Supplement for Cold Climates* (Caraco & Claytor, 1997). In addition, Appendix I of this manual provides some sizing examples that incorporate cold climate design.

IMPORTANT NOTES:

ANY PRACTICE THAT CREATES A DAM IS REQUIRED TO FOLLOW THE GUIDANCE PRESENTED IN THE [*GUIDELINES FOR DESIGN OF DAMS*](#) (APPENDIX A) AND MAY REQUIRE A PERMIT FROM THE NYSDEC. FOR THE MOST RECENT COPY OF THIS DOCUMENT, CONTACT THE NEW YORK STATE DEPARTMENT OF ENVIRONMENTAL CONSERVATION, DAM SAFETY SECTION. AN EVALUATION OF HAZARD CLASSIFICATION MUST BE INCLUDED IN THE DESIGN REPORT FOR STORMWATER PONDS OR WETLANDS CREATED BY A DAM.

THIS CHAPTER FOLLOWING TEXT PRESENTS CRITERIA IN TWO PARTS. DESIGN GUIDELINES ARE FEATURES THAT ENHANCE PRACTICE PERFORMANCE, BUT MAY NOT BE NECESSARY FOR ALL APPLICATIONS. REQUIRED ELEMENTS ARE FEATURES THAT SHOULD BE USED IN ALL APPLICATIONS. A FACT SHEET AT THE BACK OF EACH SECTION HIGHLIGHTS THE REQUIRED ELEMENTS.

APPENDICES F AND G PROVIDE EXAMPLE CHECKLISTS FOR THE CONSTRUCTION AND OPERATION&MAINTENANCE OF EACH OF THE PRACTICE TYPES.

Section 6.1 Stormwater Ponds

Stormwater ponds are practices that have either a permanent pool of water, or a combination of a permanent pool and extended detention, and some elements of a shallow marsh equivalent to the entire WQ_v. Five design variants include:

- P-1 Micropool Extended Detention Pond (Figure 6.1)
- P-2 Wet Pond (Figure 6.2)
- P-3 Wet Extended Detention Pond (Figure 6.3)
- P-4 Multiple Pond System (Figure 6.4)

New York State Stormwater Management Design Manual

Chapter 6: Performance Criteria

Section 6.1 Stormwater Ponds

- P-5 Pocket Pond

(Figure 6.5)

Treatment Suitability:

Dry extended detention ponds without a permanent pool are not considered an acceptable option for meeting water quality treatment goals. Each of the five stormwater pond designs can be used to provide channel protection volume as well as overbank and extreme flood attenuation. The term "pocket" refers to a pond or wetland that has such a small contributing drainage area that little or no baseflow is available to sustain water elevations during dry weather. Instead, water elevations are heavily influenced, and in some cases maintained, by a locally high water table.

IMPORTANT NOTES

WHILE THE STORMWATER PONDS DESIGNED ACCORDING TO THIS GUIDANCE MAY ACT AS A COMMUNITY AMMENITY, AND MAY PROVIDE SOME HABITAT VALUE, THEY CANNOT BE ANTICIPATED TO FUNCTION AS NATURAL LAKES OR PONDS.

New York State Stormwater Management Design Manual

Chapter 6: Performance Criteria

Section 6.1 Stormwater Ponds

Figure 6.1 Micropool Extended Detention Pond (P-1)

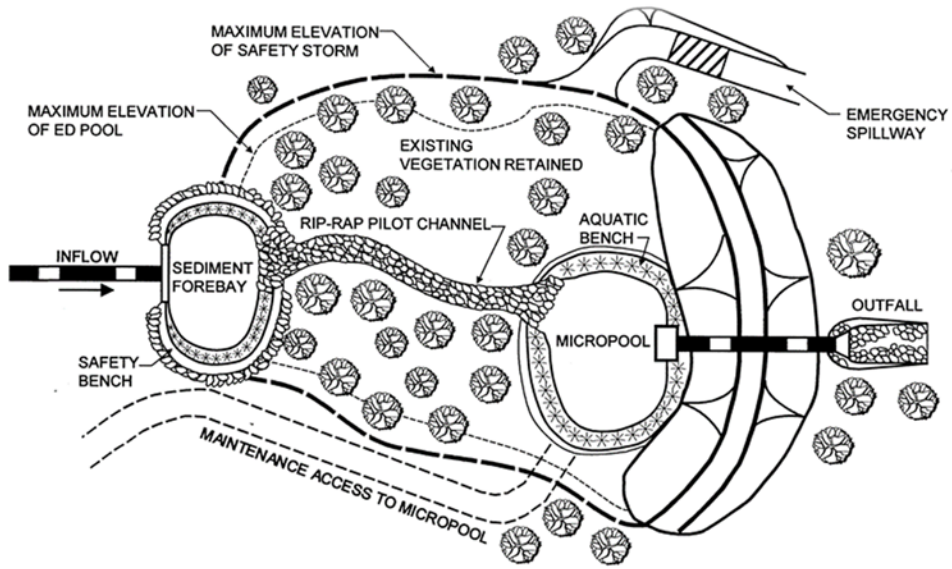

PLAN VIEW

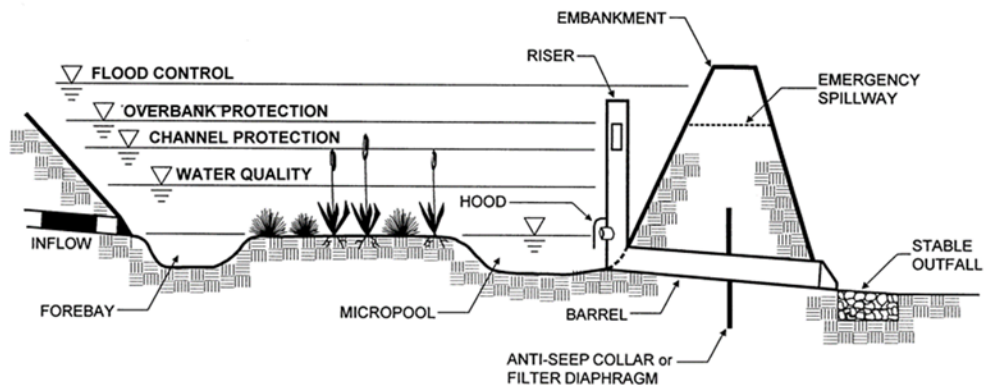

PROFILE

Figure

New York State Stormwater Management Design Manual

Chapter 6: Performance Criteria

Section 6.1 Stormwater Ponds

Figure 6.2 Wet Pond (P-2)

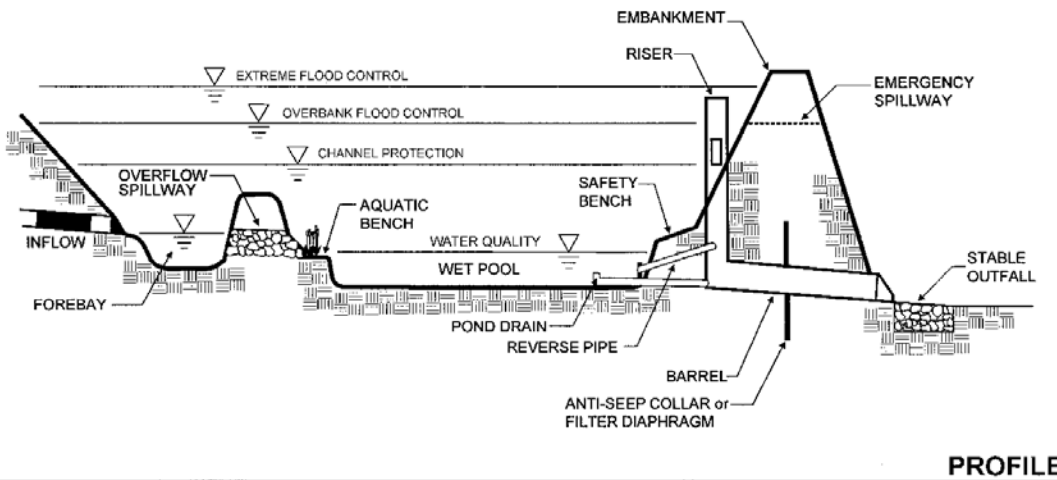
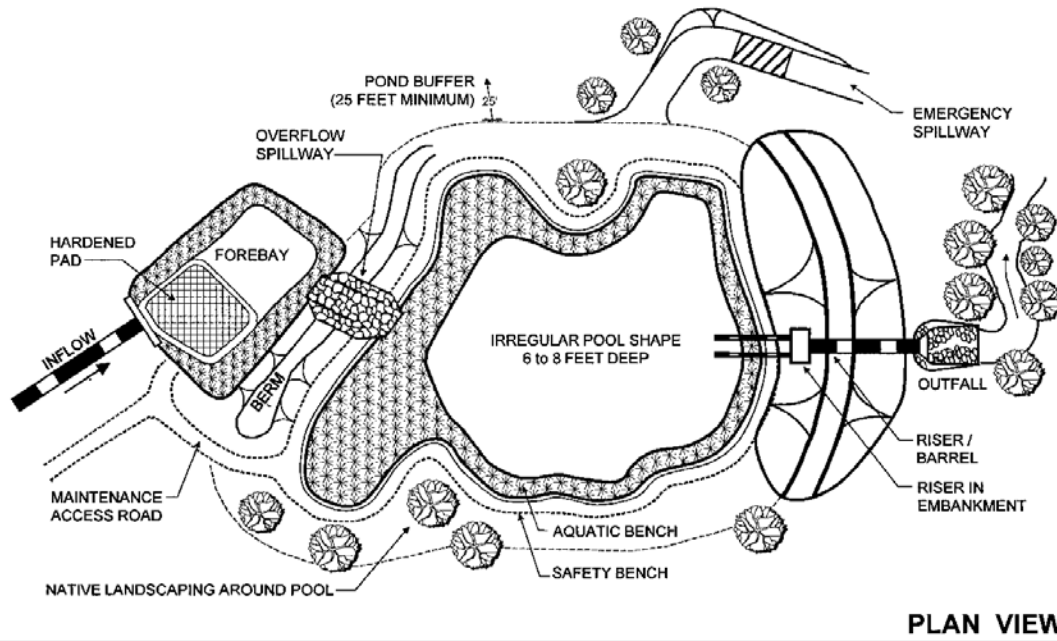

New York State Stormwater Management Design Manual

Chapter 6: Performance Criteria

Section 6.1 Stormwater Ponds

Figure 6.3 Wet Extended Detention Pond (P-3)

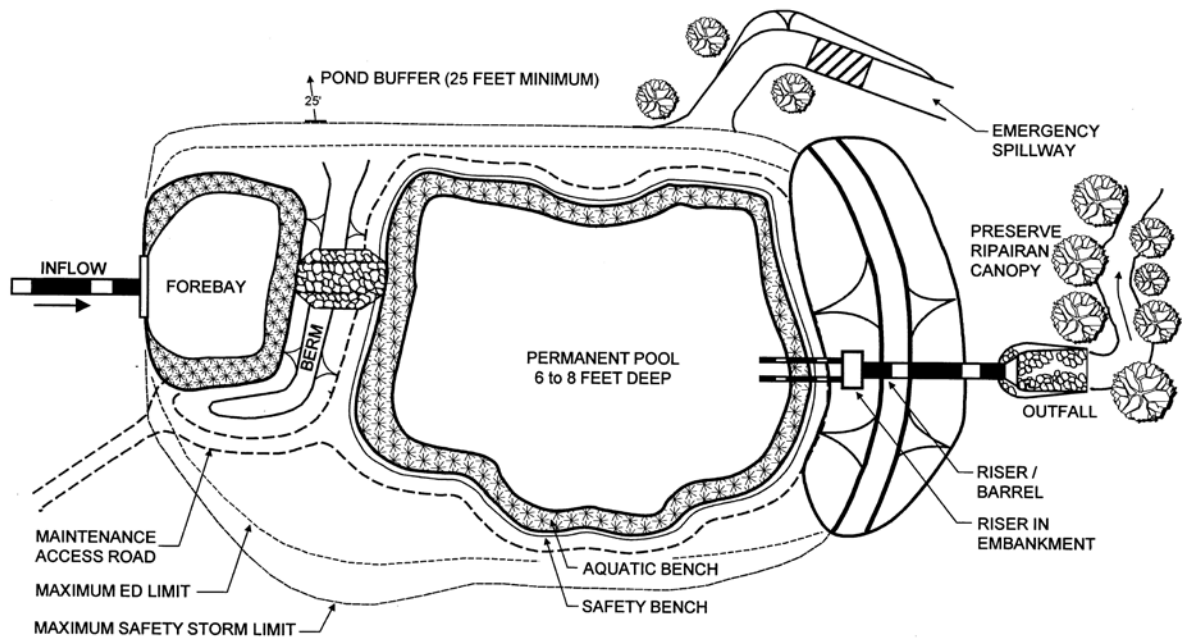

PLAN VIEW

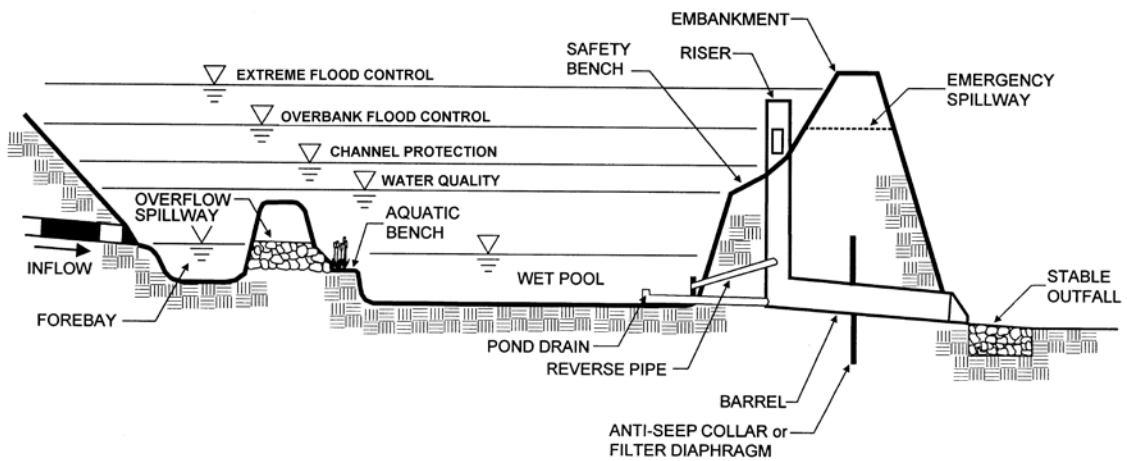

PROFILE

New York State Stormwater Management Design Manual

Chapter 6: Performance Criteria

Section 6.1 Stormwater Ponds

Figure 6.4 Multiple Pond System (P-4)

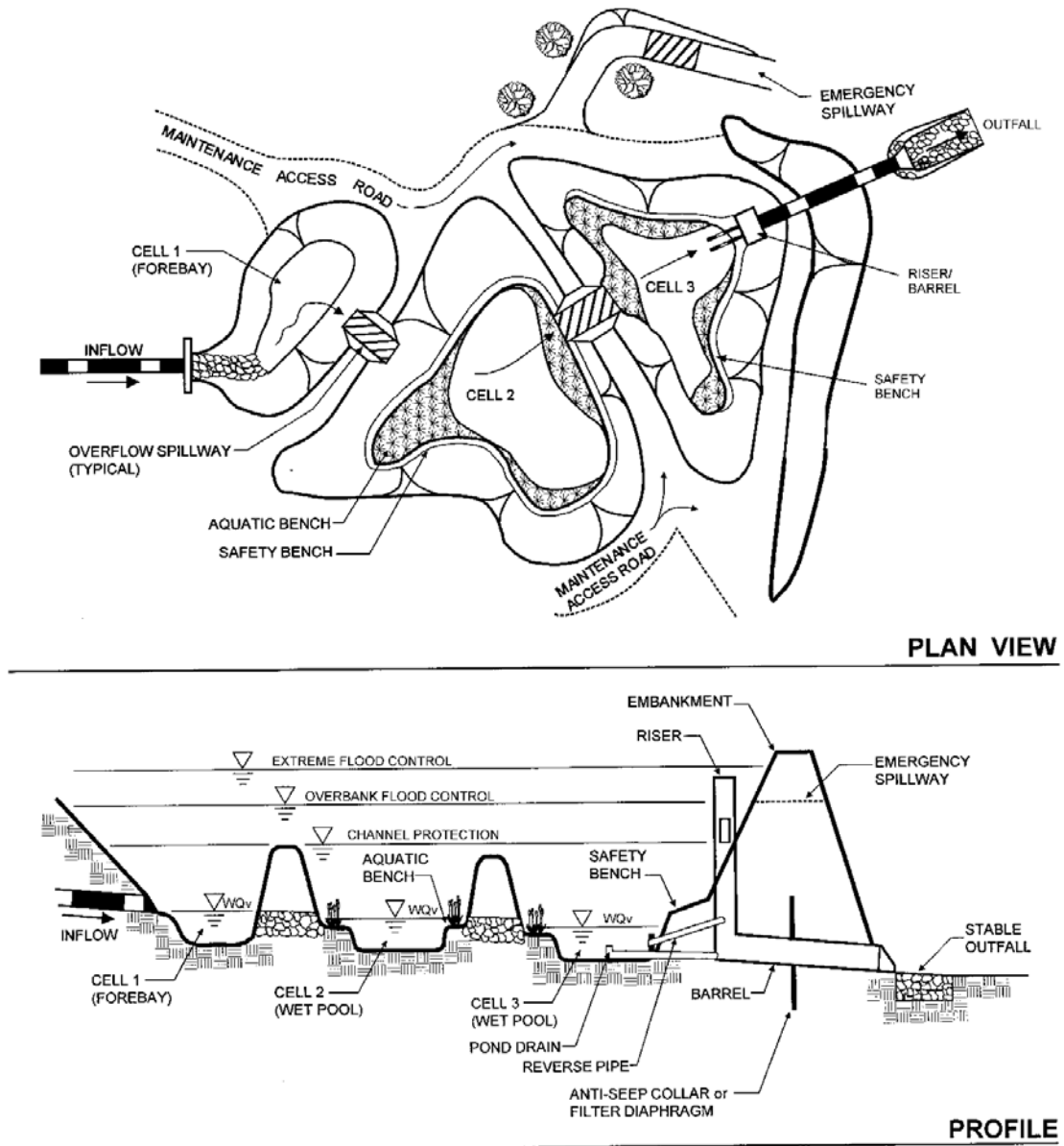

New York State Stormwater Management Design Manual

Chapter 6: Performance Criteria

Section 6.1 Stormwater Ponds

Figure 6.5 Pocket Pond (P-5)

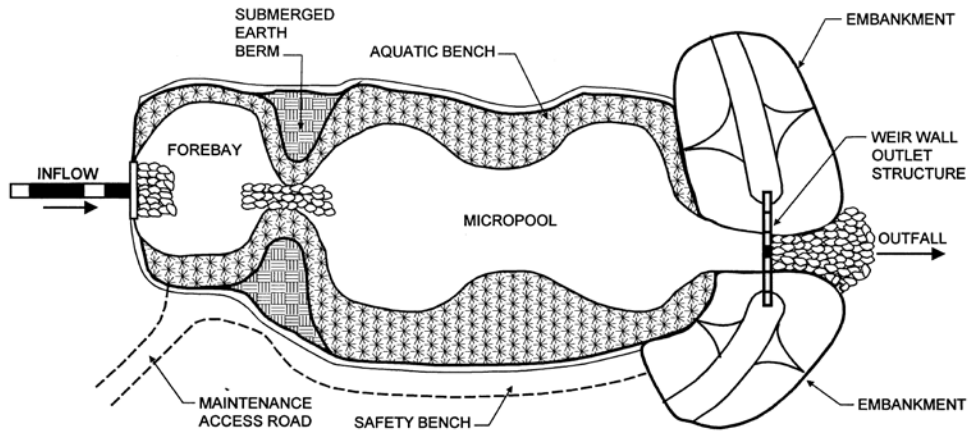

PLAN VIEW

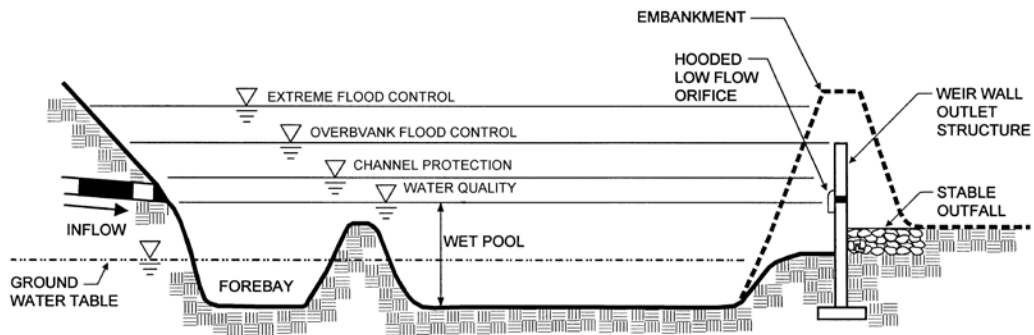

PROFILE

New York State Stormwater Management Design Manual

Chapter 6: Performance Criteria

Section 6.1 Stormwater Ponds

6.1.1 Feasibility

Required Elements

- Stormwater ponds shall not be located within jurisdictional waters, including wetlands.
- Evaluate the site to determine the Hazard Class, and to determine what design elements are required to ensure dam safety (see Guidelines for Design of Dams). For the most recent copy of this document, contact the New York State Department of Environmental Conservation, Dam Safety Division, at: 518-402-8151.
- Avoid direction of hotspot runoff to design P-5.
- Provide a 2' minimum separation between the pond bottom and groundwater in sole source aquifer recharge areas.

Design Guidance

- Designs P-2, P-3, and P-4 should have a minimum contributing drainage area of 25 acres. A 10-acre drainage is suggested for design P-1.
- The use of stormwater ponds (with the exception of design P-1, Micropool Extended Detention Pond) on trout waters is strongly discouraged, as available evidence suggests that these practices can increase stream temperatures.
- Avoid location of pond designs within the stream channel, to prevent habitat degradation caused by these structures.
- A maximum drainage area of five acres is suggested for design P-5.

6.1.2 Conveyance

Inlet Protection

Required Elements

- A forebay shall be provided at each pond inflow point, unless an inflow point provides less than 10% of the total design storm flow to the pond.

Design Guidance

- Inlet areas should be stabilized to ensure that non-erosive conditions exist for at least the 2-year frequency storm event.
- Except in cold regions of the State, the ideal inlet configuration is a partially submerged (i.e., ½ full) pipe.

Adequate Outfall Protection

New York State Stormwater Management Design Manual

Chapter 6: Performance Criteria

Section 6.1 Stormwater Ponds

Required Elements

- The channel immediately below a pond outfall shall be modified to prevent erosion and conform to natural dimensions in the shortest possible distance, typically by use of appropriately-sized riprap placed over filter cloth. Typical examples include submerged earthen berms, concrete weirs, and gabion baskets.
- A stilling basin or outlet protection shall be used to reduce flow velocities from the principal spillway to non-erosive velocities (3.5 to 5.0 fps). (See Appendix L for a table of erosive velocities for grass and soil).

Design Guidance

- Outfalls should be constructed such that they do not increase erosion or have undue influence on the downstream geomorphology of the stream.
- Flared pipe sections that discharge at or near the stream invert or into a step-pool arrangement should be used at the spillway outlet.
- If a pond daylights to a channel with dry weather flow, care should be taken to minimize tree clearing along the downstream channel, and to reestablish a forested riparian zone in the shortest possible distance. Excessive use of riprap should be avoided to reduce stream warming.

Pond Liners

Design Guidance

- When a pond is located in gravelly sands or fractured bedrock, a liner may be needed to sustain a permanent pool of water. If geotechnical tests confirm the need for a liner, acceptable options include: (a) six to 12 inches of clay soil (minimum 50% passing the #200 sieve and a maximum permeability of 1×10^{-5} cm/sec), (b) a 30 mm poly-liner (c) bentonite, (d) use of chemical additives (see *NRCS Agricultural Handbook No. 386*, dated 1961, or *Engineering Field Manual*) or (e) a design prepared by a Professional Engineer registered in the State of New York.

6.1.3 Pretreatment

Required Elements

- A sediment forebay is important for maintenance and longevity of a stormwater treatment pond. Each pond shall have a sediment forebay or equivalent upstream pretreatment. The forebay shall consist of a separate cell, formed by an acceptable barrier. Typical examples include earthen berms, concrete weirs, and gabion baskets.
- The forebay shall be sized to contain 10% of the water quality volume (WQ_v), and shall be four to six feet deep. The forebay storage volume counts toward the total WQ_v requirement.
- The forebay shall be designed with non-erosive outlet conditions, given design exit velocities.
- Direct access for appropriate maintenance equipment shall be provided to the forebay.

New York State Stormwater Management Design Manual

Chapter 6: Performance Criteria

Section 6.1 Stormwater Ponds

- In sole source aquifers, 100% of the WQ_v for stormwater runoff from designated hotspots shall be provided in pretreatment.

Design Guidance

- A fixed vertical sediment depth marker should be installed in the forebay to measure sediment deposition over time.
- The bottom of the forebay may be hardened to ease sediment removal

6.1.4 Treatment

Minimum Water Quality Volume (WQ_v)

Required Elements

- Provide water quality treatment storage to capture the computed WQ_v from the contributing drainage area through a combination of permanent pool, extended detention (WQ_v -ED) and marsh. The division of storage into permanent pool and extended detention is outlined in Table 6.1.
- Although both CP_v and WQ_v -ED storage can be provided in the same practice, WQ_v cannot be met by simply providing CP_v storage for the one-year storm.

Table 6.1 Water Quality Volume Distribution in Pond Designs		
Design Variation	%WQ_v	
	Permanent Pool	Extended Detention
P-1	20% min.	80% max.
P-2	100%	0%
P-3	50% min.	50% max.
P-4	50% min.	50% max.
P-5	50% min.	50% max.

Design Guidance

- It is generally desirable to provide water quality treatment off-line when topography, hydraulic head and space permit (i.e., apart from stormwater quantity storage; see Appendix K for a schematic).
- Water quality storage can be provided in multiple cells. Performance is enhanced when multiple treatment pathways are provided by using multiple cells, longer flowpaths, high surface area to volume ratios, complex microtopography, and/or redundant treatment methods (combinations of pool, ED, and marsh).

New York State Stormwater Management Design Manual

Chapter 6: Performance Criteria

Section 6.1 Stormwater Ponds

Minimum Pond Geometry

Required Elements

- The minimum length to width ratio for the pond is 1.5:1 (i.e., length relative to width).
- Provide a minimum Surface Area:Drainage Area of 1:100.

Design Guidance

- To the greatest extent possible, maintain a long flow path through the system, and design ponds with irregular shapes.

6.1.5 Landscaping

Pond Benches

Required Elements

- The perimeter of all deep pool areas (four feet or greater in depth) shall be surrounded by two benches:
 - Except when pond side slopes are 4:1 (h:v) or flatter, provide a safety bench that generally extends 15 feet outward (10' to 12' allowable on sites with extreme space limitations) from the normal water edge to the toe of the pond side slope. The maximum slope of the safety bench shall be 6%.
 - Incorporate an aquatic bench that generally extends up to 15 feet inward from the normal shoreline, has an irregular configuration, and a maximum depth of 18 inches below the normal pool water surface elevation. The slope proceeding from the aquatic bench to the pond basin floor *shall* not exceed 2:1 (h:v).

New York State Stormwater Management Design Manual

Chapter 6: Performance Criteria

Section 6.1 Stormwater Ponds

Figure 6.6 Slope diagram for Pond Benches

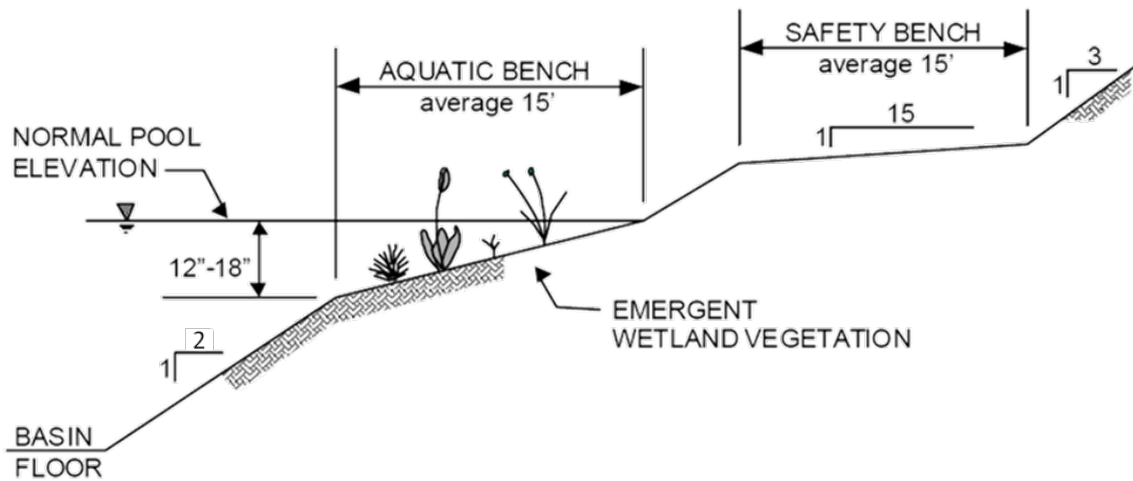

Landscaping Plan

Required Elements

- A landscaping plan for a stormwater pond and its buffer shall be prepared to indicate how aquatic and terrestrial areas will be vegetatively stabilized and established.
- Aquatic vegetation must be established in the aquatic and safety benches before the Pond is rendered in-service.

Design Guidance

- Wherever possible, wetland plants should be encouraged in a pond design, either along the aquatic bench (fringe wetlands), the safety bench and side slopes (ED wetlands) or within shallow areas of the pool itself.
- The best elevations for establishing wetland plants, either through transplantation or volunteer colonization, are within six inches (plus or minus) of the normal pool.
- The soils of a pond buffer are often severely compacted during the construction process to ensure stability. The density of these compacted soils is so great that it effectively prevents root penetration, and therefore, may lead to premature mortality or loss of vigor. Consequently, it is advisable to excavate large and deep holes around the proposed planting sites, and backfill these with uncompacted topsoil.
 - As a rule of thumb, planting holes should be three times deeper and wider than the diameter of the rootball (of balled and burlap stock), and five times deeper and wider for container grown stock. This practice should enable the stock to develop unconfined root systems. Avoid species that require full shade, are susceptible to winterkill, or are prone to wind damage. Extra mulching around the

New York State Stormwater Management Design Manual

Chapter 6: Performance Criteria

Section 6.1 Stormwater Ponds

base of the tree or shrub is strongly recommended as a means of conserving moisture and suppressing weeds.

Pond Buffers and Setbacks

Required Elements

- A pond buffer shall be provided that extends 25 feet outward from the maximum water surface elevation of the pond. The pond buffer shall be contiguous with other buffer areas that are required by existing regulations (e.g., stream buffers). An additional setback may be provided to permanent structures.
- Woody vegetation may not be planted or allowed to grow within 15 feet of the toe of the embankment and 25 feet from the principal spillway structure.

Design Guidance

- Existing trees should be preserved in the buffer area during construction. It is desirable to locate forest conservation areas adjacent to ponds. To help discourage resident geese populations, the buffer can be planted with trees, shrubs and native ground covers.
- Annual mowing of the pond buffer is only required along maintenance rights-of-way and the embankment. The remaining buffer can be managed as a meadow (mowing every other year) or forest.

6.1.6 Maintenance

Required Elements

- Maintenance responsibility for a pond and its buffer shall be vested with a responsible authority by means of a legally binding and enforceable maintenance agreement that is executed as a condition of plan approval.
- The principal spillway shall be equipped with a removable trash rack, and generally accessible from dry land.
- Sediment removal in the forebay shall occur every five to six years or after 50% of total forebay capacity has been lost.
- All required safety elements must be inspected and maintained on an annual basis, unless prior inspections indicate more frequent maintenance is required.
- All required maintenance elements must be included in a comprehensive operation and maintenance plan.

Design Guidance

- Sediments excavated from stormwater ponds that do not receive runoff from designated hotspots are generally not considered toxic or hazardous material, and can be safely disposed by either land application or land filling. Sediment testing may be required prior to sediment disposal when a hotspot land use is present (see Section 4.8 for a list of potential hotspots).

New York State Stormwater Management Design Manual

Chapter 6: Performance Criteria

Section 6.1 Stormwater Ponds

- Sediment removed from stormwater ponds should be disposed of according to an approved comprehensive operation and maintenance plan.

Maintenance Access

Required Elements

- A maintenance right of way or easement shall extend to the pond from a public or private road.

Design Guidance

- Maintenance access should be at least 12 feet wide, have a maximum slope of no more than 15%, and be appropriately stabilized to withstand maintenance equipment and vehicles.
- The maintenance access should extend to the forebay, safety bench, riser, and outlet and be designed to allow vehicles to turn around.

Non-clogging Low Flow Orifice

Required Elements

- A low flow orifice shall be provided, with the size for the orifice sufficient to ensure that no clogging shall occur. (See Appendix K for details of a low flow orifice and trash rack options).

Design Guidance

- The low flow orifice should be adequately protected from clogging by either an acceptable external trash rack (recommended minimum orifice of 3") or by internal orifice protection that may allow for smaller diameters (recommended minimum orifice of 1").
- The preferred method is a submerged reverse-slope pipe that extends downward from the riser to an inflow point one foot below the normal pool elevation.
- Alternative methods are to employ a broad crested rectangular, V-notch, or proportional weir, protected by a half-round CMP that extends at least 12 inches below the normal pool.

The use of horizontally extended perforated pipe protected by geotextile fabric and gravel is not recommended. Vertical pipes may be used as an alternative if a permanent pool is present.

Riser in Embankment

Required Elements

- The riser shall be located within the embankment for maintenance access, safety and aesthetics.

Design Guidance

New York State Stormwater Management Design Manual

Chapter 6: Performance Criteria

Section 6.1 Stormwater Ponds

- Access to the riser should be provided by lockable manhole covers, and manhole steps within easy reach of valves and other controls. The principal spillway opening should be "fenced" with pipe or rebar at 8-inch intervals (for safety purposes).

Pond Drain

Required Elements

- Except where local slopes prohibit this design, each pond shall have a drain pipe that can completely or partially drain the pond. The drain pipe shall have an elbow or protected intake within the pond to prevent sediment deposition, and a diameter capable of draining the pond within 24 hours.

Design Guidance

- Care should be exercised during pond drawdowns to prevent rapid drawdown and minimize downstream discharge of sediments or anoxic water. The approving jurisdiction should be notified before draining a pond.

Adjustable Gate Valve

Required Elements

- Both the WQv-ED outlet and the pond drain shall be equipped with an adjustable gate valve (typically a handwheel activated knife gate valve). A gate valve is not required if the WQv is discharged through a weir.
- Valves shall be located inside of the riser at a point where they (a) will not normally be inundated and (b) can be operated in a safe manner.

Design Guidance

- Both the WQv-ED pipe and the pond drain should be sized one pipe size greater than the calculated design diameter.
- To prevent vandalism, the handwheel should be chained to a ringbolt, manhole step or other fixed object.

Safety Features

Required Elements

- Side slopes to the pond shall not exceed 3:1 (h:v), and shall terminate at a safety bench.
- Side slope proceeding from aquatic bench to pond basin floor shall not exceed 2:1 (h:v).
- Both the safety bench and the aquatic bench must be landscaped to prevent access to the deep pool. The vegetation must be established before pond is rendered in-service.

New York State Stormwater Management Design Manual

Chapter 6: Performance Criteria

Section 6.1 Stormwater Ponds

- Warning signs must be posted prohibiting swimming, wading, and skating, warning of possible contamination or pollution of pond water, and indicating maximum depth of pond.
- The principal spillway opening shall not permit access by small children, and endwalls above pipe outfalls greater than 48 inches in diameter shall be fenced to prevent a hazard.
- When the pond slope requirements or any other required safety feature cannot be met perimeter fencing is required at or above the maximum water surface level provided that all required maintenance can still be performed.

6.1.7 Cold Climate Pond Design Considerations

Inlets, outlet structures and outfall protection for pond systems require modifications to function well in cold climates. Among the problems those wishing to use stormwater ponds in cold climates may encounter are:

- Higher runoff volumes and increased pollutant loads during the spring melt
- Pipe freezing and clogging
- Ice formation on the permanent pool
- Road sand build-up

Higher runoff volumes and increased pollutant loads during the spring melt

- Operate the pond based on seasonal inputs by adjusting dual water quality outlets to provide additional storage (see Figure 6.6).
- Adapt sizing based on snowmelt characteristics (see Appendix I).
- Do not drain ponds during the spring season. Due to temperature stratification and high chloride concentrations at the bottom, the water may become highly acidic and anoxic and may cause negative downstream effects.

Pipe Freezing and Clogging

- Inlet pipes should not be submerged, since this can result in freezing and upstream damage or flooding.
- Bury all pipes below the frost line to prevent frost heave and pipe freezing. Bury pipes at the point furthest from the pond deeper than the frost line to minimize the length of pipe exposed.
- Increase the slope of inlet pipes to a minimum of 1% to prevent standing water in the pipe, reducing the potential for ice formation. This design may be difficult to achieve at sites with flat local slopes.
- If perforated riser pipes are used, the minimum orifice diameter should be ½". In addition, the pipe should have a minimum 6" diameter.

New York State Stormwater Management Design Manual

Chapter 6: Performance Criteria

Section 6.1 Stormwater Ponds

- When a standard weir is used, the minimum slot width should be 3", especially when the slot is tall.
- Baffle weirs can prevent ice formation near the outlet by preventing surface ice from blocking the inlet, encouraging the movement of baseflow through the system (see Appendix K).
- In cold climates, riser hoods and reverse slope pipes should draw from at least 6" below the typical ice layer. This design encourages circulation in the pond, preventing stratification and formation of ice at the outlet.
- Trash racks should be installed at a shallow angle to prevent ice formation (see Appendix K).

Figure 6.6 Seasonal Operation Pond

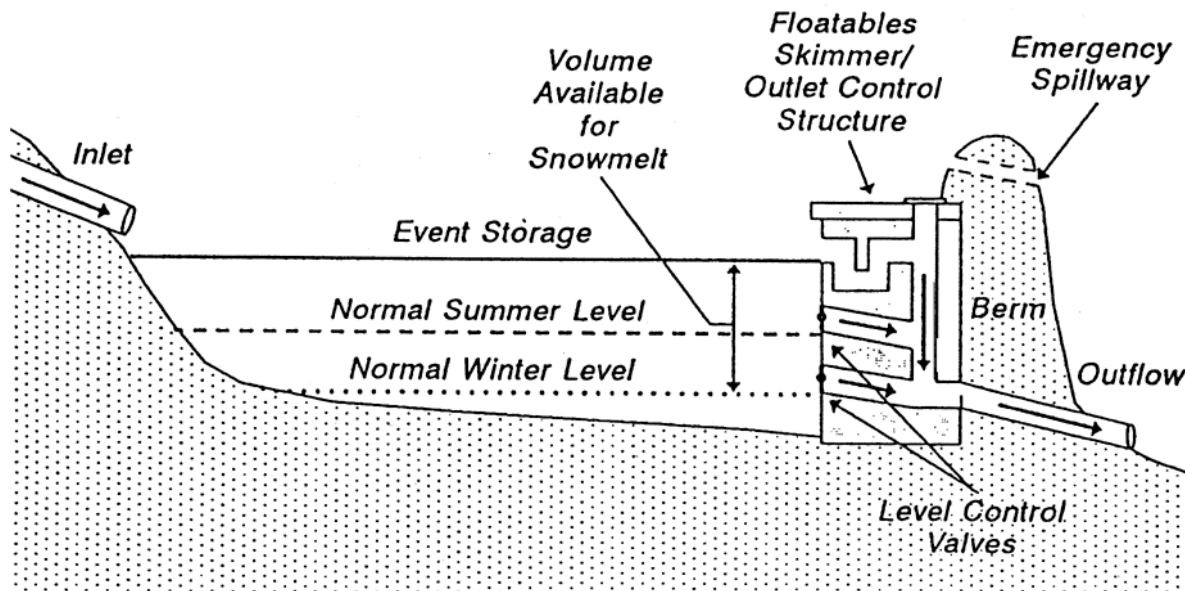

Ice Formation on the Permanent Pool

- In cold climates, the treatment volume of a pond system should be adjusted to account for ice build-up on the permanent pool by providing one foot of elevation above the WQv. The total depth of the pond, including this additional elevation, should not exceed eight feet.
- Using pumps or bubbling systems can reduce ice build-up and prevent the formation of an anaerobic zone in pond bottoms.
- Provide some storage as extended detention. This recommendation is made for very cold climates to provide detention while the permanent pond is iced over. In effect, it discourages the use of wet ponds (P-2), replacing them with wet extended detention ponds (P-3).
- Multiple pond systems are recommended regardless of climate because they provide redundant treatment options. In cold climates, a berm or simple weir should be used instead of pipes to separate multiple ponds, due to their higher freezing potential.

Road Sand Build-up

- In areas where road sand is used, an inspection of the forebay and pond should be scheduled after the spring melt to determine if dredging is necessary. For forebays, dredging is needed if one half of the capacity of the forebay is full.

New York State Stormwater Management Design Manual

Chapter 6: Performance Criteria

Section 6.1 Stormwater Ponds

Stormwater Ponds



Description: Constructed stormwater retention basin that has a permanent pool (or micropool). Runoff from each rain event is detained and treated in the pool through settling and biological uptake mechanisms.

Design Options: Micropool Extended Detention (P-1), Wet Pond (P-2), Wet Extended Detention (P-3), Multiple Pond (P-4), Pocket Pond (P-5)

<u>KEY CONSIDERATIONS</u>	<u>STORMWATER MANAGEMENT SUITABILITY</u>
<p>FEASIBILITY</p> <ul style="list-style-type: none"> Contributing drainage area greater than 10 acres for P-1, 25 acres for P-2 to P-4. Follow DEC Guidelines for Design of Dams. Provide a minimum 2' separation from the groundwater in sole source aquifers. Do not locate ponds in jurisdictional wetlands. Avoid directing hotspot runoff to design P-5. <p>CONVEYANCE</p> <ul style="list-style-type: none"> Forebay at each inlet, unless the inlet contributes less than 10% of the total inflow, 4' to 6' deep. Stabilize the channel below the pond to prevent erosion. Stilling basin at the outlet to reduce velocities. <p>PRETREATMENT</p> <ul style="list-style-type: none"> Forebay volume at least 10% of the WQ_v Forebay shall be designed with non-erosive outlet conditions. Provide direct access to the forebay for maintenance equipment In sole source aquifers, provide 100% pretreatment for hotspot runoff. <p>TREATMENT</p> <ul style="list-style-type: none"> Provide the water quality volume in a combination of permanent pool and extended detention (Table 6.1 in manual provides limitations on storage breakdown) Minimum length to width ratio of 1.5:1 Minimum surface area to drainage area ratio of 1:100 <p>LANDSCAPING</p>	<ul style="list-style-type: none"> <input checked="" type="checkbox"/> Water Quality <input checked="" type="checkbox"/> Channel Protection <input checked="" type="checkbox"/> Overbank Flood Protection <input checked="" type="checkbox"/> Extreme Flood Protection <p>Accepts Hotspot Runoff: <i>Yes</i> (2 feet minimum separation distance required to water table)</p> <p style="text-align: center;"><u>FEASIBILITY CONSIDERATIONS</u></p> <ul style="list-style-type: none"> <input type="checkbox"/> Cost <input type="checkbox"/> Maintenance Burden <p style="text-align: center;">Key: L=Low M=Moderate H=High</p> <p>Residential Subdivision Use: <i>Yes</i></p> <p>High Density/Ultra-Urban: <i>No</i></p> <p>Soils: <i>Hydrologic group 'A' soils may require pond liner</i> <i>Hydrologic group 'D' soils may have compaction constraints</i></p> <p>Other Considerations:</p> <ul style="list-style-type: none"> <i>Thermal effects</i>

New York State Stormwater Management Design Manual

Chapter 6: Performance Criteria

Section 6.1 Stormwater Ponds

- Provide a minimum 10' and preferably 15' safety bench extending from the high water mark, with a maximum slope of 6%.
- Provide an aquatic bench extending 15 feet outward from the shoreline, and a maximum depth of 18" below normal water elevation.
- Develop a landscaping plan.
- Provide a 25' pond buffer.
- No woody vegetation within 15 feet of the toe of the embankment, or 25 feet from the principal spillway.

MAINTENANCE REQUIREMENTS

- Legally binding maintenance agreement
- Sediment removal from forebay every five to six years or when 50% full.
- Provide a maintenance easement and right-of-way.
- Removable trash rack on the principal spillway.
- Non-clogging low flow orifice
- Riser in the embankment.
- Pond drain required, capable of drawing down the pond in 24 hours.
- Notification required for pond drainage.
- Provide an adjustable gate valve on both the WQ_v-ED pipe, and the pond drain.
- Side Slopes less than 3:1, and terminate at a safety bench.
- Principal spillway shall not permit access by small children, and endwalls above pipes greater than 48" in diameter shall be fenced.

- *Outlet clogging*
- *Safety bench*

POLLUTANT REMOVAL

- G** Phosphorus
- G** Nitrogen
- G** Metals - Cadmium, Copper, Lead, and Zinc removal
- G** Pathogens Coliform, E.Coli, Streptococci removal

Key: G=Good F=Fair P=Poor

New York State Stormwater Management Design Manual

Chapter 6: Performance Criteria

Section 6.2 Stormwater Wetlands

Section 6.2 Stormwater Wetlands

Stormwater wetlands are practices that create shallow marsh areas to treat urban stormwater and often incorporate small permanent pools and/or extended detention storage to achieve the full WQv. Design variants include:

- W-1 Shallow Wetland (Figure 6.7)
- W-2 ED Shallow Wetland (Figure 6.8)
- W-3 Pond/Wetland System (Figure 6.9)
- W-4 Pocket Wetland (Figure 6.10)

Wetland designs W-1 through W-4 can be used to provide Channel Protection volume as well as Overbank and Extreme Flood attenuation. In these design variations, the permanent pool is stored in a depression excavated into the ground surface. Wetland plants are planted at the wetland bottom, particularly in the shallow regions.

IMPORTANT NOTES

ALL OF THE POND CRITERIA PRESENTED IN PERFORMANCE CRITERIA – PONDS (CHAPTER 6.1) ALSO APPLY TO THE DESIGN OF STORMWATER WETLANDS. ADDITIONAL CRITERIA THAT GOVERN THE GEOMETRY AND ESTABLISHMENT OF CREATED WETLANDS ARE PRESENTED IN THIS SECTION.

ANY PRACTICE THAT CREATES A DAM IS REQUIRED TO FOLLOW THE GUIDANCE PRESENTED IN THE GUIDELINES FOR DESIGN OF DAMS (APPENDIX A) AND MAY REQUIRE A PERMIT FROM THE NYSDEC. FOR THE MOST RECENT COPY OF THIS DOCUMENT, CONTACT THE NEW YORK STATE DEPARTMENT OF ENVIRONMENTAL CONSERVATION, DAM SAFETY SECTION. AN EVALUATION OF HAZARD CLASSIFICATION MUST BE INCLUDED IN THE DESIGN REPORT FOR STORMWATER WETLANDS CREATED BY A DAM.

WHILE THE STORMWATER WETLANDS DESIGNED ACCORDING TO THIS GUIDANCE MAY ACT AS A COMMUNITY AMMENITY, AND MAY PROVIDE SOME HABITAT VALUE, THEY CANNOT BE ANTICIPATED TO FUNCTION AS NATURAL WETLANDS

New York State Stormwater Management Design Manual

Chapter 6: Performance Criteria

Section 6.2 Stormwater Wetlands

Figure 6.7 Shallow Wetland (W-1)

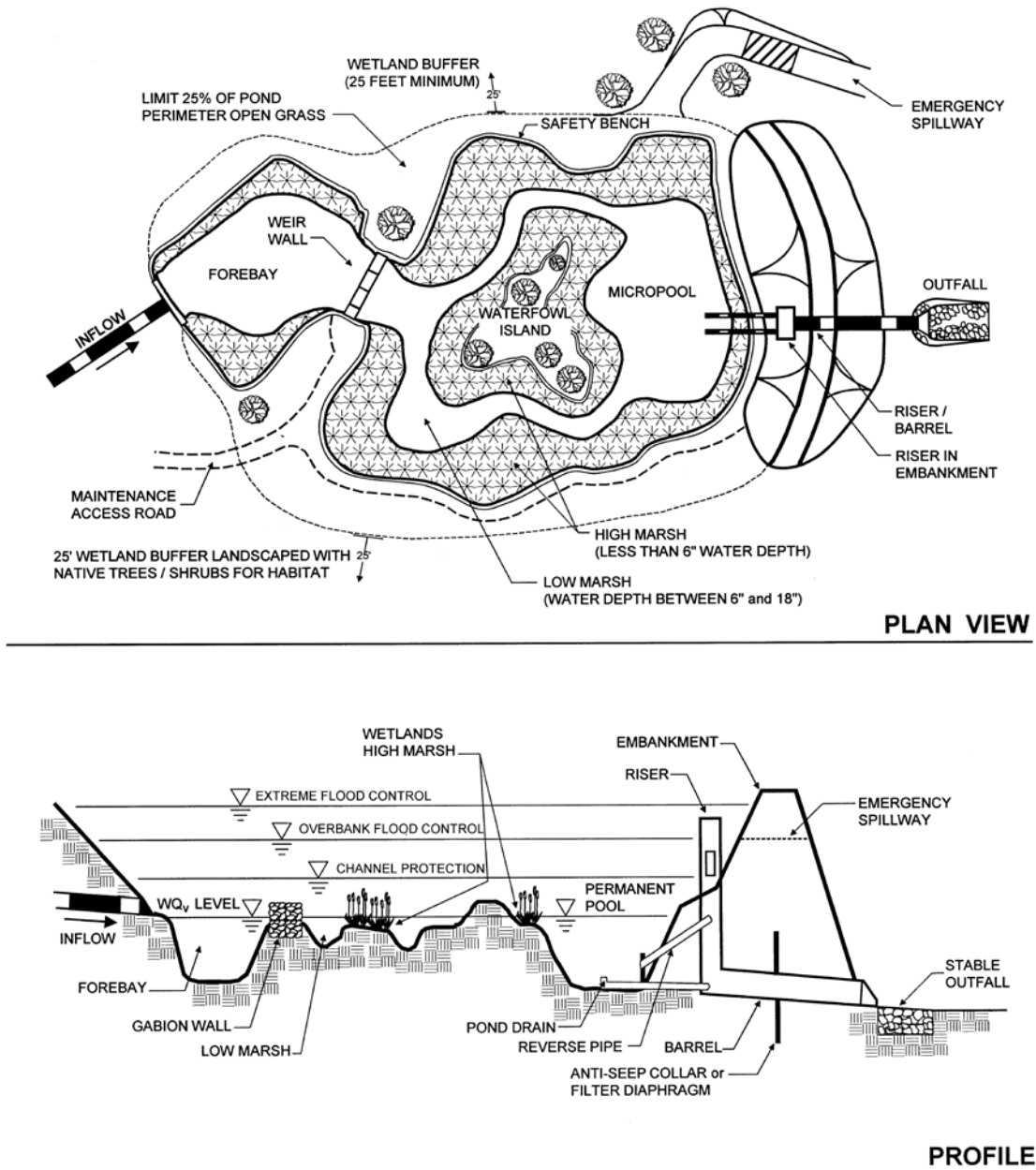
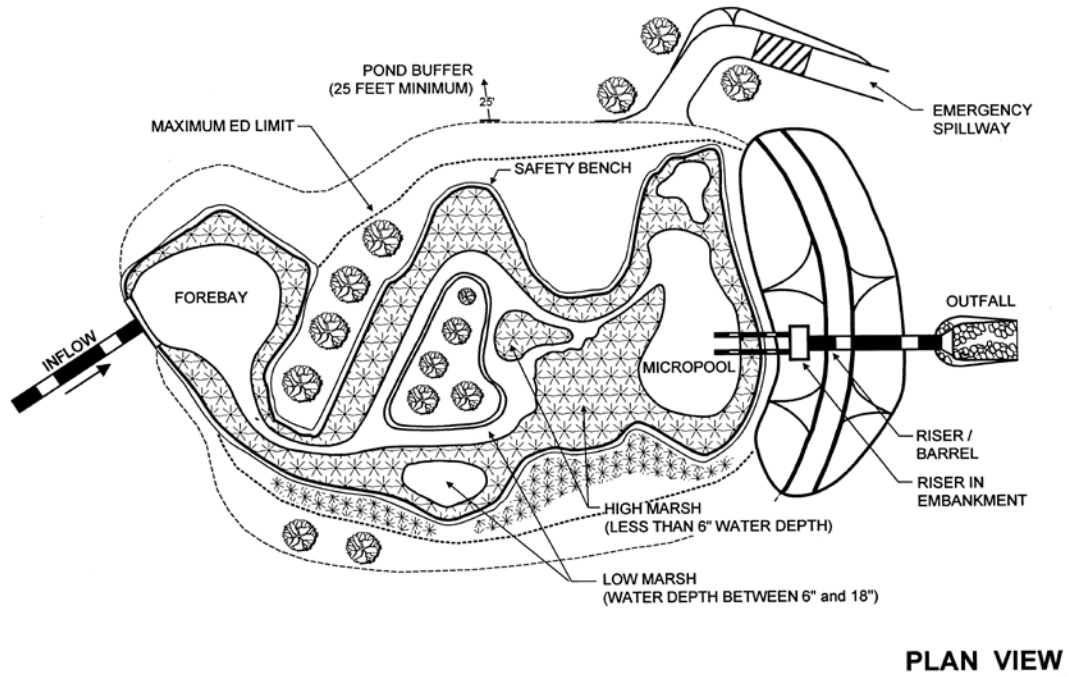
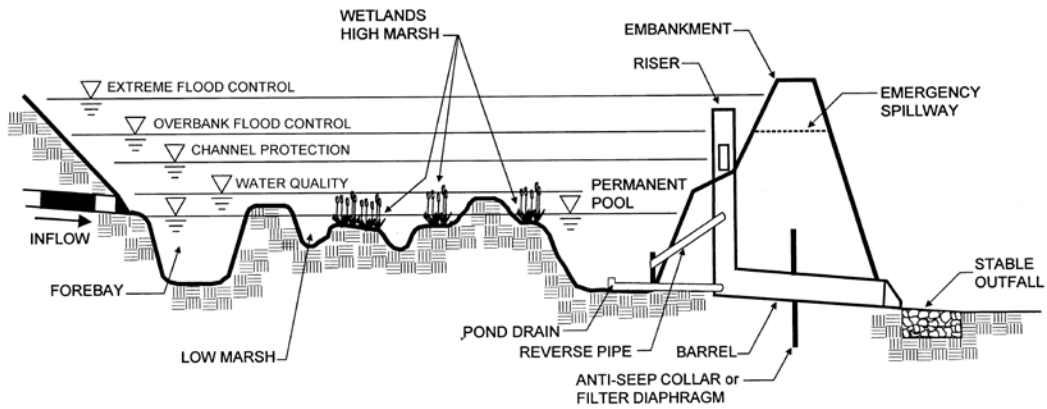

Figure 6.8 Extended Detention Shallow Wetland (W-2)



PLAN VIEW



PROFILE

New York State Stormwater Management Design Manual

Chapter 6: Performance Criteria

Section 6.2 Stormwater Wetlands

Figure 6.9 Pond/Wetland System (W-3)

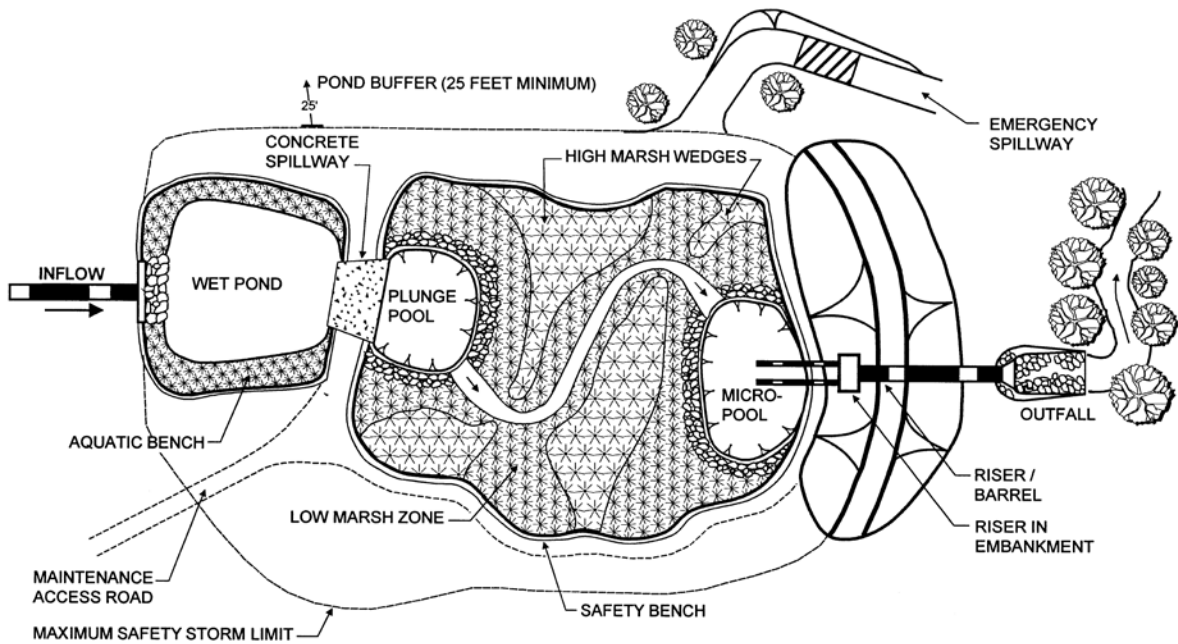

PLAN VIEW

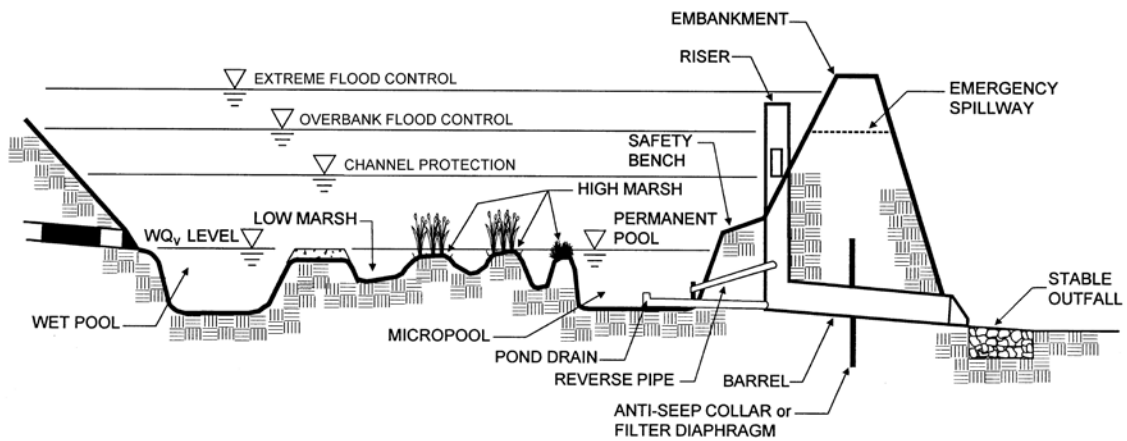

PROFILE

New York State Stormwater Management Design Manual

Chapter 6: Performance Criteria

Section 6.2 Stormwater Wetlands

Figure 6.10 Pocket Wetland (W-4)

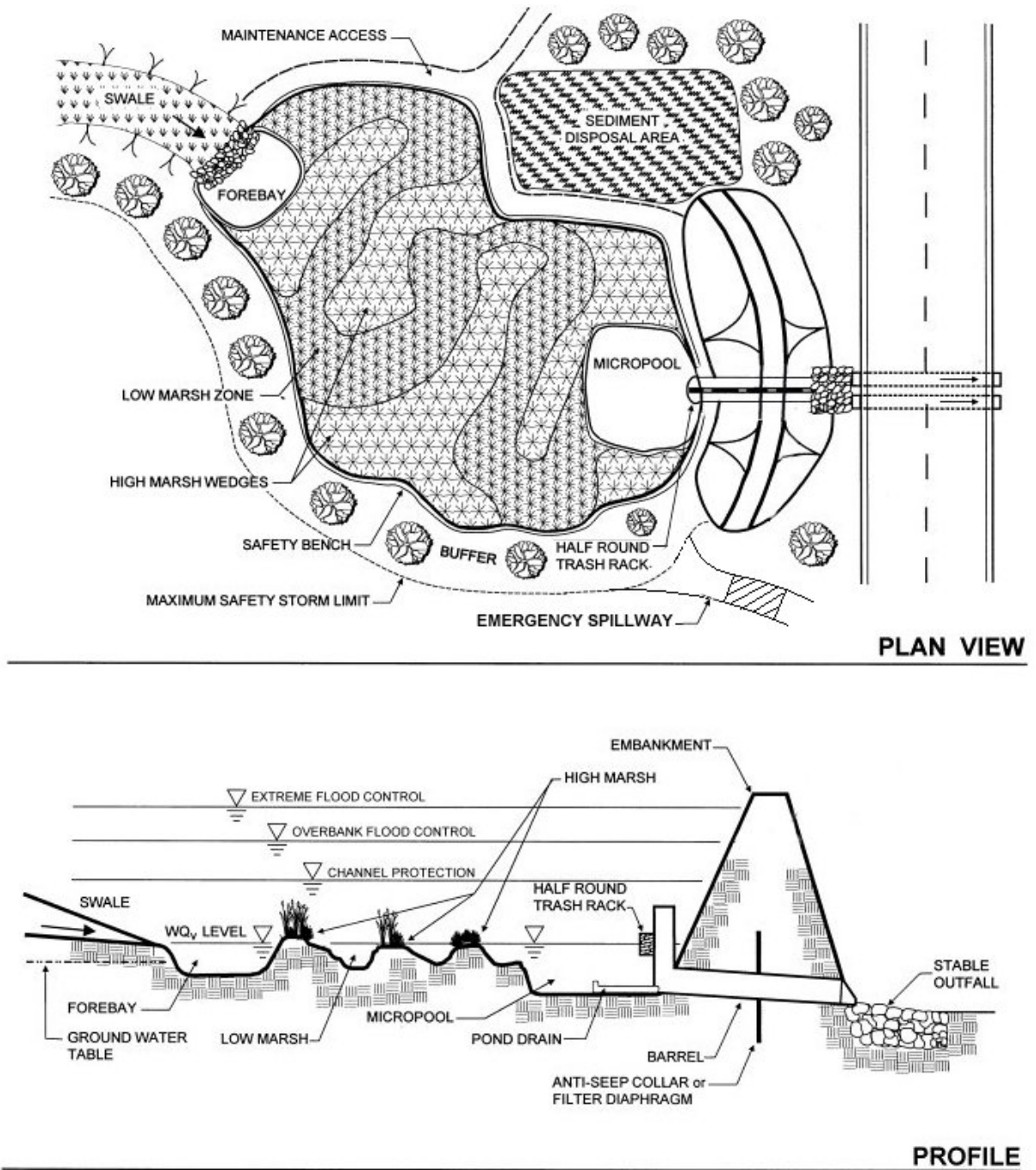

New York State Stormwater Management Design Manual

Chapter 6: Performance Criteria

Section 6.2 Stormwater Wetlands

6.2.1 Feasibility

Design Guidance

- *Stormwater wetlands should not be located within existing jurisdictional wetlands.* In some isolated cases, a permit may be granted to convert an existing degraded wetland in the context of local watershed restoration efforts.
- The use of stormwater wetlands on trout waters is strongly discouraged, as available evidence suggests that these practices can increase stream temperatures.

6.2.2 Conveyance

Required Elements

- Flowpaths from the inflow points to the outflow points of stormwater wetlands shall be maximized.
- A minimum flowpath of 2:1 (length to relative width) shall be provided across the stormwater wetland. This path may be achieved by constructing internal berms (e.g., high marsh wedges or rock filter cells).

Design Guidance

- Microtopography is encouraged to enhance wetland diversity.

6.2.3 Treatment

Required Elements

- The surface area of the entire stormwater wetland shall be at least one percent of the contributing drainage area (1.5% for shallow marsh design).
- A minimum of 35% of the total surface area can have a depth of six inches or less, and at least 65% of the total surface area shall be shallower than 18 inches.
- At least 25% of the WQ_v shall be in deepwater zones with a depth greater than four feet.
- If extended detention is used in a stormwater wetland, provide a minimum of 50% of the WQ_v in permanent pool; the maximum water surface elevation of WQ_v -ED shall not extend more than three feet above the permanent pool.
- A forebay shall be located at the inlet, and a four to six foot deep micropool that stores approximately 10% of the WQ_v shall be located at the outlet to protect the low flow pipe from clogging and prevent sediment resuspension.

Design Guidance

- The bed of stormwater wetlands should be graded to create maximum internal flow path and microtopography.

New York State Stormwater Management Design Manual

Chapter 6: Performance Criteria

Section 6.2 Stormwater Wetlands

- To promote greater nitrogen removal, rock beds may be used as a medium for growth of wetland plants. The rock should be one to three inches in diameter, placed up to the normal pool elevation, and open to flow-through from either direction.

6.2.4 Landscaping

Required Elements

- A landscaping plan shall be provided that indicates the methods used to establish and maintain wetland coverage. Minimum elements of a plan include: delineation of pondscaping zones, selection of corresponding plant species, planting plan, sequence for preparing wetland bed (including soil amendments, if needed) and sources of plant material.
- A wetland plant buffer must extend 25 feet outward from the maximum water surface elevation, with an additional 15-foot setback to structures.
- Donor soils for wetland mulch shall not be removed from natural wetlands.

Design Guidance

- Structures such as fascines, coconut rolls, straw bales, or carefully designed stone weirs can be used to create shallow marsh cells in high-energy areas of the stormwater wetland.
- The landscaping plan should provide elements that promote greater wildlife and waterfowl use within the wetland and buffers.
- Follow wetland establishment guidelines (see Appendix H).

6.2.5 Maintenance

Required Elements

- If a minimum coverage of 50% is not achieved in the planted wetland zones after the second growing season, a reinforcement planting is required.

6.2.6 Cold Climate Design Considerations

Many of the cold climate concerns for wetlands are very similar to the ones for ponds. Two additional concerns with regards to stormwater wetlands focus on cold climate impacts to wetland plants:

- Short Growing Season
- Chlorides

Short Growing Season

- Planting schedule should reflect the short growing season, perhaps incorporating relatively mature plants, or planting rhizomes during the winter.

New York State Stormwater Management Design Manual

Chapter 6: Performance Criteria

Section 6.2 Stormwater Wetlands

Chlorides

- Use in combination with a grassed infiltration area prior to the wetland to provide some infiltration of chlorides to dampen the shock to wetland plants
- Emphasize the pond/wetland design option to dilute chlorides prior to the wetland area. If this option is used, the pond should use the modifications described in Section 6.1.7. The pond system dilutes chlorides before they enter the marsh, protecting wetland plants.
- Consider salt-tolerant plants if wetland treats runoff from roads or parking lots where salt is used as a deicer.

New York State Stormwater Management Design Manual

Chapter 6: Performance Criteria

Section 6.2 Stormwater Wetlands

Stormwater Wetlands



Description: Stormwater wetlands (a.k.a. constructed wetlands) are structural practices that incorporate wetland plants into the design to both store and treat runoff. As stormwater runoff flows through the wetland, pollutant removal is achieved through settling and biological uptake within the practice

Design Options: Shallow wetland (W-1), Extended Detention Wetland (W-2), Pond/Wetland (W-3), Pocket Wetland (W-4)

<u>KEY CONSIDERATIONS</u>	<u>STORMWATER MANAGEMENT SUITABILITY</u>
<p>MUST MEET ALL OF THE REQUIREMENTS OF STORMWATER PONDS.</p> <p>CONVEYANCE</p> <ul style="list-style-type: none"> • Minimum flowpath of 2:1 (length to width) • Flowpath maximized <p>TREATMENT</p> <ul style="list-style-type: none"> • Micropool at outlet, capturing 10% of the WQ_v • Minimum surface area to drainage area ratio of 1:100 • ED no greater than 50% of entire WQ_v (permanent pool at least 50% of the volume) 25% of the WQ_v in deepwater zones. • 35% of the total surface area in depths six inches or less, and 65% shallower than 18" <p>LANDSCAPING</p> <ul style="list-style-type: none"> • Landscaping plan that indicates methods to establish and maintain wetland coverage. Minimum elements include: delineation of pondscaping zones, selection of species, planting plan, and sequence for bed preparation. • Wetland buffer 25 feet from maximum surface elevation, with 15 foot additional setback for structures. • Donor plant material must not be from natural wetlands <p>MAINTENANCE REQUIREMENTS</p> <ul style="list-style-type: none"> • Reinforcement plantings after second season if 50% coverage not achieved <p style="text-align: center;"><u>POLLUTANT REMOVAL</u></p> <p>G Phosphorus</p> <p>G Nitrogen</p> <p>F Metals - Cadmium, Copper, Lead, and Zinc removal</p> <p>G Pathogens - Coliform, Streptococci, E.Coli removal</p> <p style="text-align: center;">Key: G=Good F=Fair P=Poor</p>	<p>Water Quality</p> <p>Channel Protection</p> <p>Overbank Flood Protection</p> <p>Extreme Flood Protection</p> <p>Accepts Hotspot Runoff: Yes <i>(2 feet minimum separation distance required to water table)</i></p> <p style="text-align: center;"><u>IMPLEMENTATION CONSIDERATIONS</u></p> <p>M Capital Cost</p> <p style="text-align: center;">Maintenance Burden:</p> <p>M Shallow Wetland</p> <p>M ED Shallow Wetland</p> <p>H Pocket Wetland</p> <p>M Pond/Wetland</p> <p>Residential Subdivision Use: Yes</p> <p>High-Density/Ultra-Urban: No</p> <p>Soils: Hydrologic group 'A' and 'B' soils may require liner</p> <p style="text-align: center;">Key: L=Low M=Moderate H=High</p>

New York State Stormwater Management Design Manual

Chapter 6: Performance Criteria

Section 6.3 Stormwater Infiltration

Section 6.3 Stormwater Infiltration

Stormwater infiltration practices capture and temporarily store the WQ_v before allowing it to infiltrate into the soil over a two-day period. Design variants include the following:

- I-1 Infiltration Trench (Figure 6.11)
- I-2 Infiltration Basin (Figure 6.12)
- I-3 Dry Well (Figure 6.13)

Treatment Suitability: Infiltration practices alone typically cannot meet detention (Q_p) and channel protection (Cp_v) requirements, except on sites where the soil infiltration rate is greater than 5.0 in/hr. However, extended detention storage may be provided above an infiltration basin. Extraordinary care should be taken to assure that long-term infiltration rates are achieved through the use of performance bonds, post construction inspection and long-term maintenance.

New York State Stormwater Management Design Manual

Chapter 6: Performance Criteria

Section 6.3 Stormwater Infiltration

Figure 6.11 Infiltration Trench (I-1)

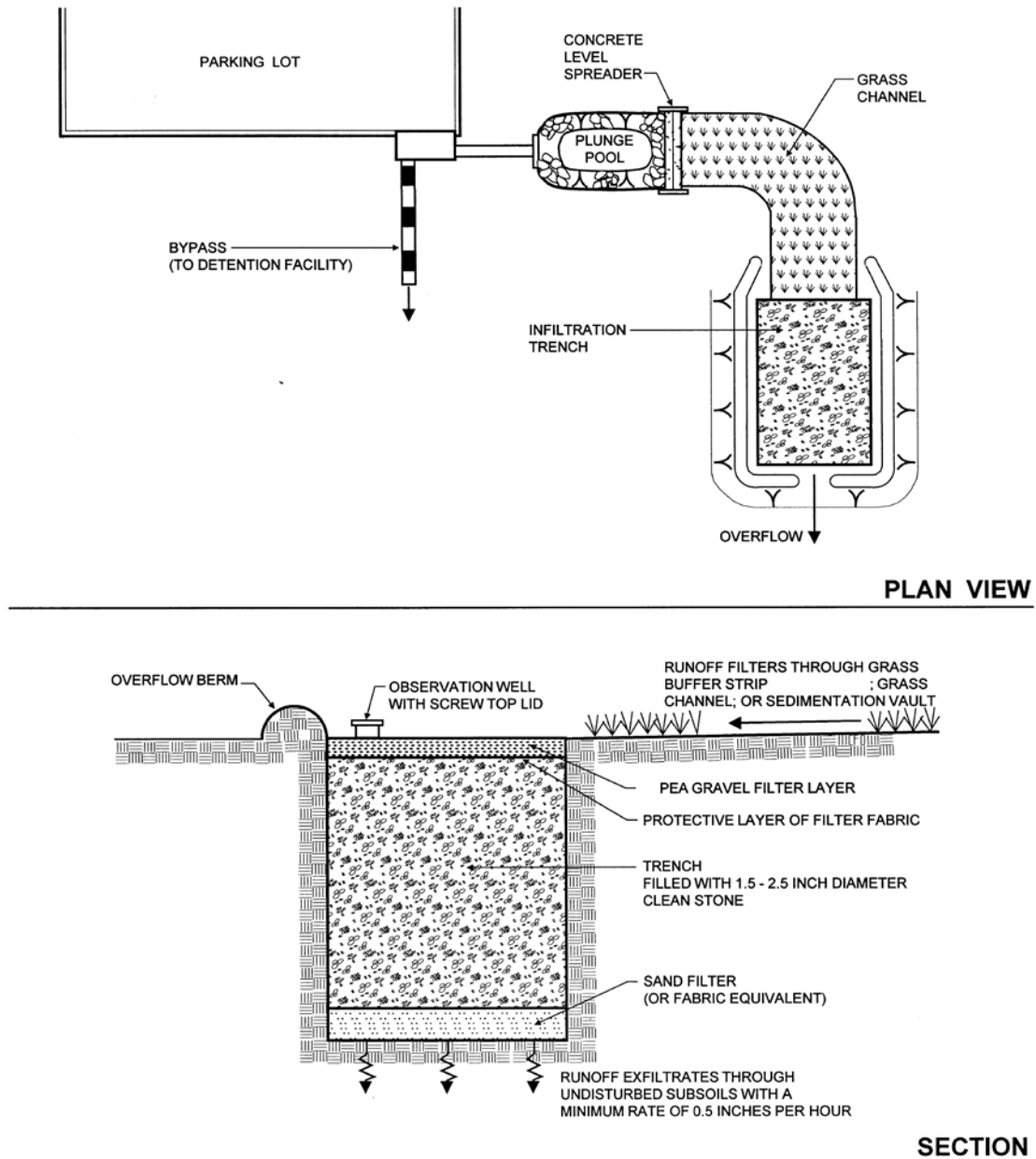

New York State Stormwater Management Design Manual

Chapter 6: Performance Criteria

Section 6.3 Stormwater Infiltration

Figure 6.12 Infiltration Basin (I-2)

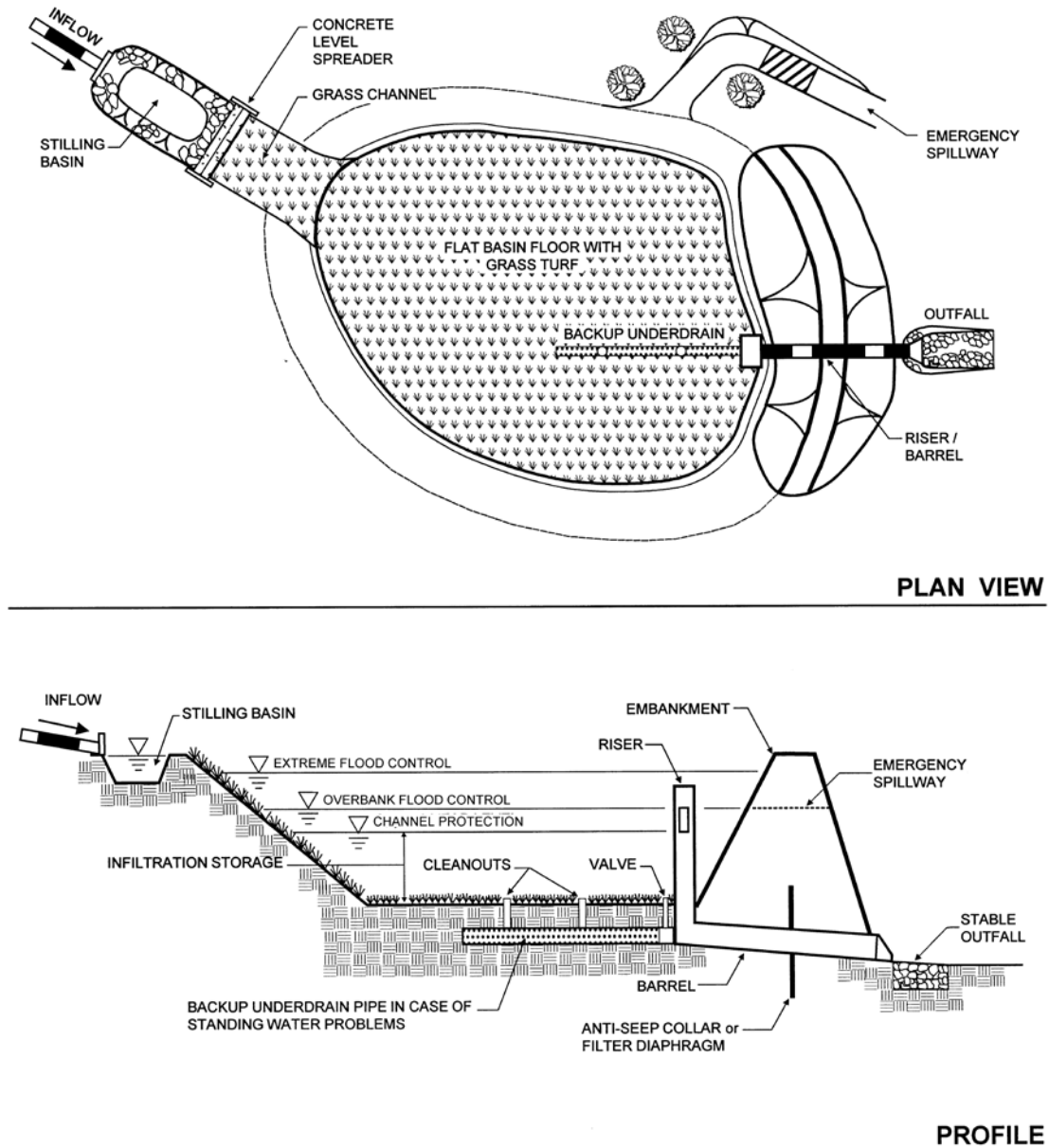

New York State Stormwater Management Design Manual

Chapter 6: Performance Criteria

Section 6.3 Stormwater Infiltration

Figure 6.13 Dry Well (I-3)

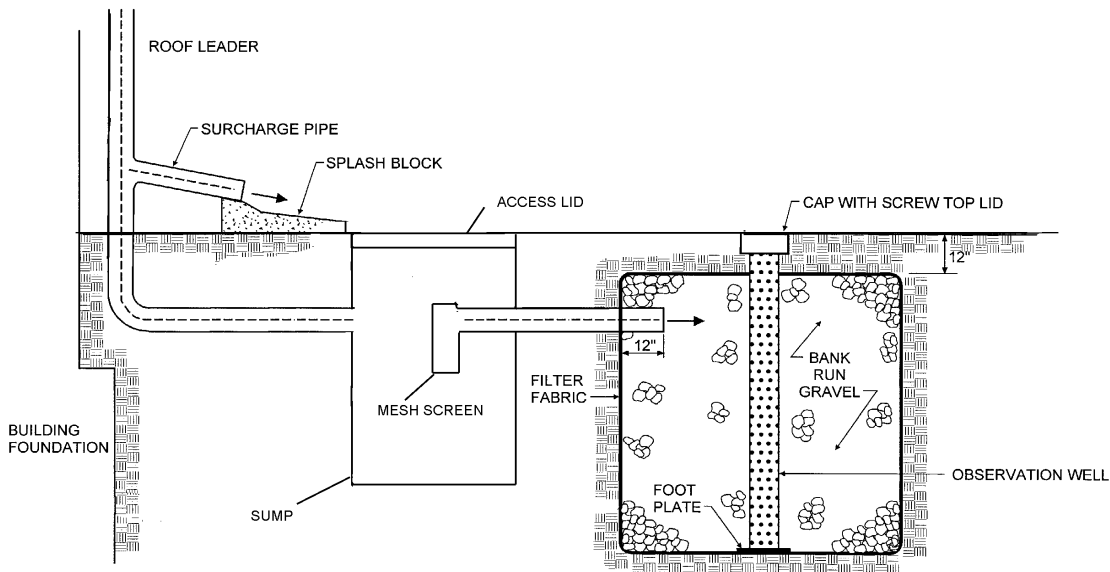

6.3.1 Feasibility

Required Elements

- To be suitable for infiltration, underlying soils shall have an infiltration rate (f_c) of at least 0.5 inches per hour, as initially determined from NRCS soil textural classification, and subsequently confirmed by field geotechnical tests (see Appendix D). The minimum geotechnical testing is one test hole per 5000 sf, with a minimum of two borings per facility (taken within the proposed limits of the facility).
- Soils shall also have a clay content of less than 20% and a silt/clay content of less than 40%.
- Infiltration practices cannot be located on areas with natural slopes greater than 15%.
- Infiltration practices cannot be located in fill soils, except the top quarter of an infiltration trench or dry well.
- To protect groundwater from possible contamination, runoff from designated hotspot land uses or activities must not be directed to a formal infiltration facility. In cases where this goal is impossible (e.g., where the storm drain system leads to a large recharge facility designed for flood control), redundant pretreatment must be provided by applying two of the practices listed in Table 5.1 in series, both of which are sized to treat the entire WQ_v .
- The bottom of the infiltration facility shall be separated by at least three feet vertically from the seasonally high water table or bedrock layer, as documented by on-site soil testing. (Four feet in sole source aquifers).

New York State Stormwater Management Design Manual

Chapter 6: Performance Criteria

Section 6.3 Stormwater Infiltration

- Infiltration facilities shall be located at least 100 feet horizontally from any water supply well.
- Infiltration practices cannot be placed in locations that cause water problems to downgradient properties. Infiltration trenches and basins shall be setback 25 feet downgradient from structures and septic systems. Dry wells shall be separated a minimum of 10 feet from structures.

Design Guidance

- The maximum contributing area to infiltration basins or trenches should generally be less than five acres. The infiltration basin can theoretically receive runoff from larger areas, provided that the soil is highly permeable (i.e., greater than 5.0 inches per hour). (See Appendix L for erosive velocities of grass and soil).
- The maximum drainage area to dry wells should generally be smaller than one acre, and should include rooftop runoff only.

6.3.2 Conveyance

Required Elements

- The overland flow path of surface runoff exceeding the capacity of the infiltration system shall be evaluated to preclude erosive concentrated flow during the overbank events. If computed flow velocities exceed erosive velocities (3.5 to 5.0 fps), an overflow channel shall be provided to a stabilized watercourse. (See Appendix L for erosive velocities of grass and soil).
- All infiltration systems shall be designed to fully de-water the entire WQ_v within 48 hours after the storm event.
- If runoff is delivered by a storm drain pipe or along the main conveyance system, the infiltration practice must be designed as an off-line practice (see Appendix K for a detail), except when used as a regional flood control practice.

Design Guidance

- For infiltration basins and trenches, adequate stormwater outfalls should be provided for the overflow associated with the 10-year design storm event (non-erosive velocities on the down-slope)
- For dry wells, all flows that exceed the capacity of the dry well should be passed through the surcharge pipe.

6.3.3 Pretreatment

Required Elements

- A minimum pretreatment volume of 25% of the WQ_v must be provided prior to entry to an infiltration facility, and can be provided in the form of a sedimentation basin, sump pit, grass channel, plunge pool or other measure.
- If the f_c for the underlying soils is greater than 2.00 inches per hour, a minimum pretreatment volume of 50% of the WQ_v must be provided.

New York State Stormwater Management Design Manual

Chapter 6: Performance Criteria

Section 6.3 Stormwater Infiltration

- If the f_c for the underlying soils is greater than 5.00 inches per hour, 100% of the WQ_v shall be pre-treated prior to entry into an infiltration facility.
- Exit velocities from pretreatment chambers shall be non-erosive (3.5 to 5.0 fps) during the two-year design storm). (See Appendix L for erosive velocities of grass and soil).

Pretreatment Techniques to Prevent Clogging

Infiltration basins or trenches can have redundant methods to ensure the long-term integrity of the infiltration rate. The following techniques are pretreatment options for infiltration practices:

- Grass channel (Maximum velocity of 1 fps for water quality flow. See the Fact Sheet on page 5-10 for more detailed design information.)
- Grass filter strip (minimum 20 feet and only if sheet flow is established and maintained)
- Bottom sand layer (for I-1)
- Upper sand layer (for I-1; 6" minimum with filter fabric at sand/gravel interface)
- Use of washed bank run gravel as aggregate
- Alternatively, a pre-treatment settling chamber may be provided and sized to capture the pretreatment volume. Use the method prescribed in section 6.4.3 (i.e., the Camp-Hazen equation) to size the chamber.
- Plunge Pool
- An underground trap with a permanent pool between the downspout and the dry well (I-3)

Design Guidance

- The sides of infiltration trenches and dry wells should be lined with an acceptable filter fabric that prevents soil piping.
- In infiltration trench designs, incorporate a fine gravel or sand layer above the coarse gravel treatment reservoir to serve as a filter layer.

6.3.4 Treatment

Required Elements

- Infiltration practices shall be designed to exfiltrate the entire WQ_v through the floor of each practice (sides are not considered in sizing).
- The construction sequence and specifications for each infiltration practice shall be precisely followed. Experience has shown that the longevity of infiltration practices is strongly influenced by the care taken during construction
- Calculate the surface area of infiltration trenches as:

New York State Stormwater Management Design Manual

Chapter 6: Performance Criteria

Section 6.3 Stormwater Infiltration

$$A_p = V_w / (nd_t)$$

Where:

A_p	=	surface area (sf)
V_w	=	design volume (e.g., WQ_v) (ft^3)
n	=	porosity (assume 0.4)
d_t	=	trench depth (maximum of four feet, and separated at least three feet from seasonally high groundwater) (ft)

- Calculate the approximate bottom area of infiltration basins using the following equation:

$$A = V_w/d_b$$

Where:

A	=	surface area of the basin (ft^2)
d_b	=	depth of the basin (ft)

NOTE THAT IN TRAPEZOIDAL BASINS, THIS AREA SHOULD FIRST BE USED TO APPROXIMATE THE AREA AT THE BOTTOM OF THE BASIN, BUT CAN LATER BE MODIFIED TO ACCOUNT FOR ADDITIONAL STORAGE PROVIDED ABOVE SIDE SLOPES.

Design Guidance

- Infiltration practices are best used in conjunction with other practices, and downstream detention is often needed to meet the C_p and Q_p sizing criteria.
- A porosity value (V_v/V_t) of 0.4 can be used to design stone reservoirs for infiltration practices.

The bottom of the stone reservoir should be completely flat so that infiltrated runoff will be able to infiltrate through the entire surface.

6.3.5 Landscaping

Required Elements

- Upstream construction shall be completed and stabilized before connection to a downstream infiltration facility. A dense and vigorous vegetative cover shall be established over the contributing pervious drainage areas before runoff can be accepted into the facility.
- Infiltration trenches shall not be constructed until all of the contributing drainage area has been completely stabilized.

Design Guidance

- Mow upland and adjacent areas, and seed bare areas.

New York State Stormwater Management Design Manual

Chapter 6: Performance Criteria

Section 6.3 Stormwater Infiltration

6.3.6 Maintenance

Required Elements

- Infiltration practices shall never serve as a sediment control device during site construction phase. In addition, the Erosion and Sediment Control plan for the site shall clearly indicate how sediment will be prevented from entering an infiltration facility. Normally, the use of diversion berms around the perimeter of the infiltration practice, along with immediate vegetative stabilization and/or mulching can achieve this goal.
- An observation well shall be installed in every infiltration trench and dry well, consisting of an anchored six- inch diameter perforated PVC pipe with a lockable cap installed flush with the ground surface.
- Direct access shall be provided to infiltration practices for maintenance and rehabilitation. If a stone reservoir or perforated pipe is used to temporarily store runoff prior to infiltration, the practice shall not be covered by an impermeable surface.

Design Guidance

- OSHA trench safety standards should be consulted if the infiltration trench will be excavated more than five feet.
- Infiltration designs should include dewatering methods in the event of failure. Dewatering can be accomplished with underdrain pipe systems that accommodate drawdown.

6.3.7 Cold Climate Design Considerations

Because of additional challenges in cold climates, infiltration SMPs need design modifications to function properly. These modifications address the following problems:

- Reduced infiltration into frozen soils
- Chlorides

Reduced Infiltration

- Draining the ground beneath an infiltration system with an underdrain can increase cold weather soil infiltration.
- Another alternative is to divide the treatment volume between an infiltration SMP and another SMP to provide some treatment during the winter months.
- A seasonally operated infiltration/detention facility combines several techniques to improve the performance of infiltration SMPs in cold climates. Two features, the underdrain system and level control valves, are useful in cold climates. The level control and valves are opened at the beginning of the winter season and the soil is allowed to drain. As the snow begins to melt in the spring, the valves are closed, and the snowmelt is infiltrated until the capacity of the soil is reached. After this point, the facility acts as a detention facility, providing storage for particles to settle (Figure 6.14)

New York State Stormwater Management Design Manual

Chapter 6: Performance Criteria

Section 6.3 Stormwater Infiltration

Chlorides

- Consider diverting snowmelt runoff past infiltration devices, especially in regions where chloride concentration in groundwater is a concern.
- Incorporate mulch into infiltration basin soil to mitigate problems with soil fertility.
- The selection of upland landscaping materials should include salt-tolerant grasses where appropriate.

New York State Stormwater Management Design Manual

Chapter 6: Performance Criteria

Section 6.3 Stormwater Infiltration

Figure 6.14 Seasonal Operation Infiltration Facility

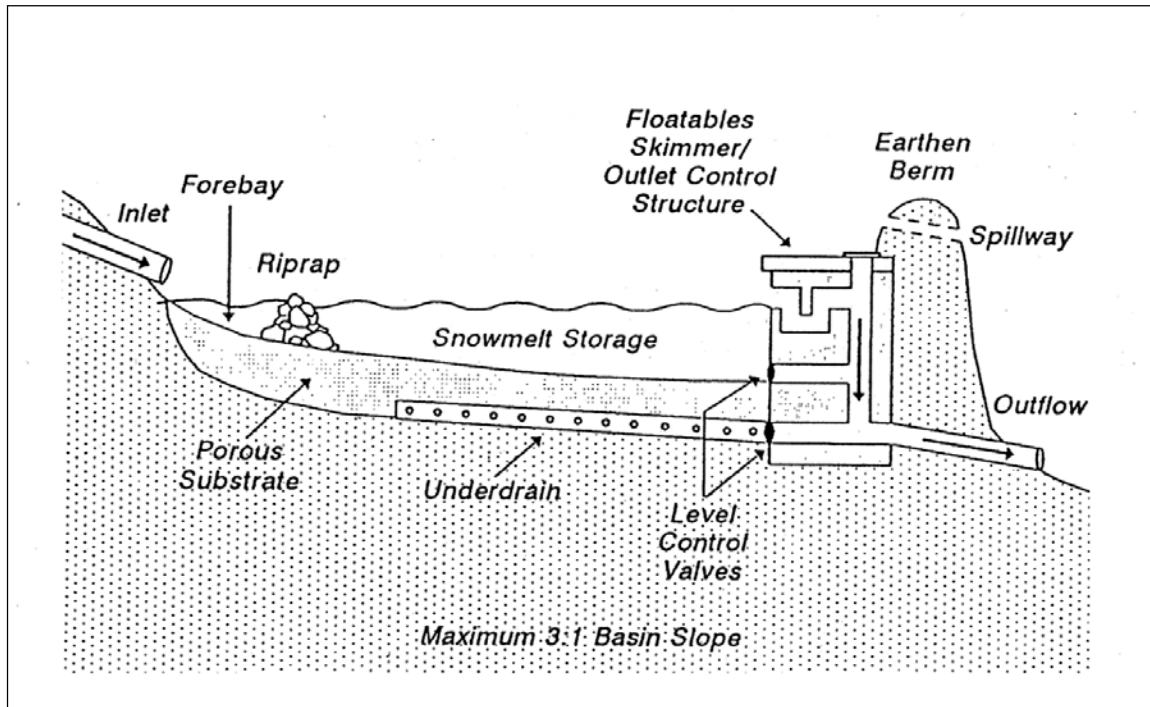

New York State Stormwater Management Design Manual

Chapter 6: Performance Criteria

Section 6.3 Stormwater Infiltration

Infiltration Practices



Description: Excavated trench or basin used to capture and allow infiltration of stormwater runoff into the surrounding soils from the bottom and sides of the basin or trench.

Design Options: Infiltration Trench (I-1), Shallow Infiltration Basin (I-2), Dry Well (I-3)

<u>KEY CONSIDERATIONS</u>	<u>STORMWATER MANAGEMENT SUITABILITY</u>
<p>FEASIBILITY</p> <ul style="list-style-type: none"> • Minimum soil infiltration rate of 0.5 inches per hour • Soils less than 20% clay, and 40% silt/clay, and no fill soils. • Natural slope less than 15% • Cannot accept hotspot runoff, except under the conditions outlined in Section 6.3.1. • Separation from groundwater table of at least three feet (four feet in sole source aquifers). • 25' separation from structures for I-1 and I-2; 10' for I-3. <p>CONVEYANCE</p> <ul style="list-style-type: none"> • Flows exiting the practice must be non-erosive (3.5 to 5.0 fps) • Maximum dewatering time of 48 hours. • Design off-line if stormwater is conveyed to the practice by a storm drain pipe. <p>PRETREATMENT</p> <ul style="list-style-type: none"> • Pretreatment of 25% of the WQ_v at all sites. • 50% pretreatment if $f_c > 2.0$ inches/hour. • 100% pretreatment in areas with $f_c > 5.0$ inches/hour. • Exit velocities from pretreatment must be non-erosive for the 2-year storm. <p>TREATMENT</p> <ul style="list-style-type: none"> • Water quality volume designed to exfiltrate through the floor of the practice. • Construction sequence to maximize practice life. 	<ul style="list-style-type: none"> <input checked="" type="checkbox"/> Water Quality <input checked="" type="checkbox"/> Channel Protection <input type="checkbox"/> Overbank Flood Protection <input type="checkbox"/> Extreme Flood Protection <p>Accepts Hotspot Runoff: <i>No</i></p> <p style="text-align: center;"><u>IMPLEMENTATION CONSIDERATIONS</u></p> <ul style="list-style-type: none"> <input type="checkbox"/> Capital Cost <input type="checkbox"/> Maintenance Burden <p>Residential Subdivision Use: <i>Yes</i></p> <p>High Density/Ultra-Urban: <i>Yes</i></p> <p>Drainage Area: <i>10 acres max.</i></p> <p>Soils: <i>Pervious soils required (0.5 in/hr or greater)</i></p> <p>Other Considerations:</p> <ul style="list-style-type: none"> • <i>Must not be placed under pavement or concrete</i>

New York State Stormwater Management Design Manual

Chapter 6: Performance Criteria

Section 6.3 Stormwater Infiltration

<ul style="list-style-type: none">• Trench depth shall be less than four feet (I-2 and I-3).• Follow the methodologies in Chapter 6 to size practices. <p>LANDSCAPING</p> <ul style="list-style-type: none">• Upstream area shall be completely stabilized before flow is directed to the practice. <p>MAINTENANCE REQUIREMENTS</p> <ul style="list-style-type: none">• Never serves as a sediment control device• Observation well shall be installed in every trench, (6" PVC pipe, with a lockable cap)• Provide direct maintenance access.	<p>Key: L=Low M=Moderate H=High</p> <p><u>POLLUTANT REMOVAL</u></p> <p>G Phosphorus</p> <p>G Nitrogen</p> <p>G Metals - Cadmium, Copper, Lead, and Zinc removal</p> <p>G Pathogens - Coliform, Streptococci, E.Coli removal</p> <p>Key: G=Good F=Fair P=Poor</p>
---	---

New York State Stormwater Management Design Manual

Chapter 6: Performance Criteria

Section 6.4 Stormwater Filtering Systems

Section 6.4 Stormwater Filtering Systems

Stormwater filtering systems capture and temporarily store the WQ_v and pass it through a filter bed of sand, organic matter, or soil. Filtered runoff may be collected and returned to the conveyance system, or allowed to partially exfiltrate into the soil. Design variants include:

- F-1 Surface Sand Filter (Figure 6.15)
- F-2 Underground Sand Filter (Figure 6.16)
- F-3 Perimeter Sand Filter (Figure 6.17)
- F-4 Organic Filter (Figure 6.18)
- F-5 Bioretention (Figure 6.19)

Treatment Suitability: Filtering systems should not be designed to provide stormwater detention (Q_p) or channel protection (C_{p_v}) except under extremely unusual conditions. Filtering practices shall generally be combined with a separate facility to provide those controls.

New York State Stormwater Management Design Manual

Chapter 6: Performance Criteria

Section 6.4 Stormwater Filtering Systems

Figure 6.15 Surface Sand Filter (F-1)

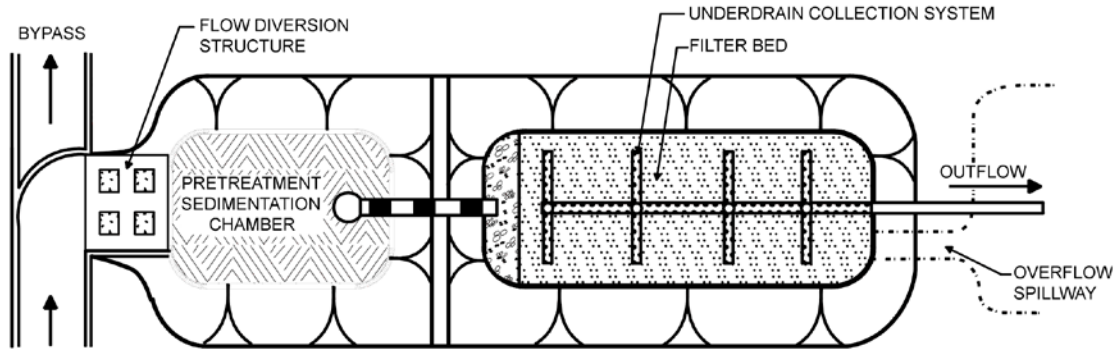

PLAN VIEW

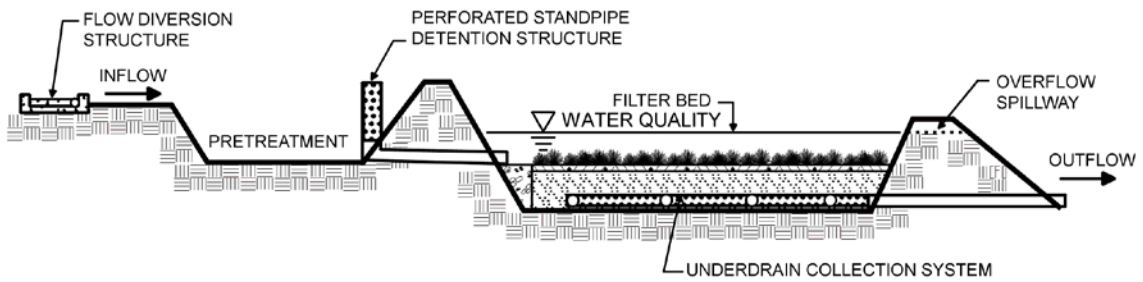

PROFILE

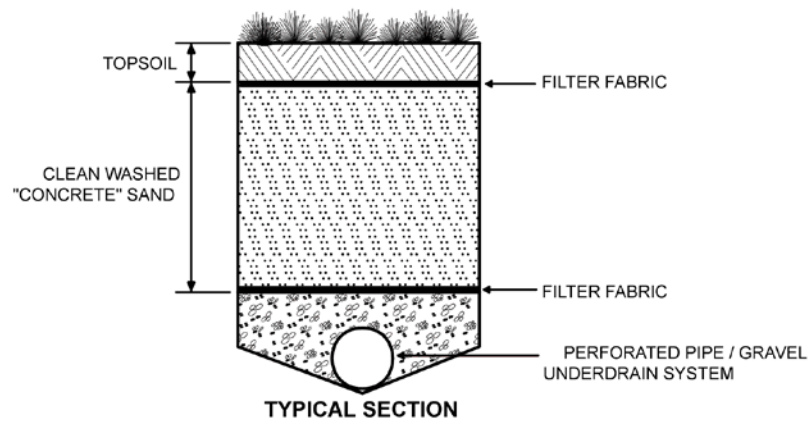

TYPICAL SECTION

New York State Stormwater Management Design Manual

Chapter 6: Performance Criteria

Section 6.4 Stormwater Filtering Systems

Figure 6.16 Underground Sand Filter (F-2)

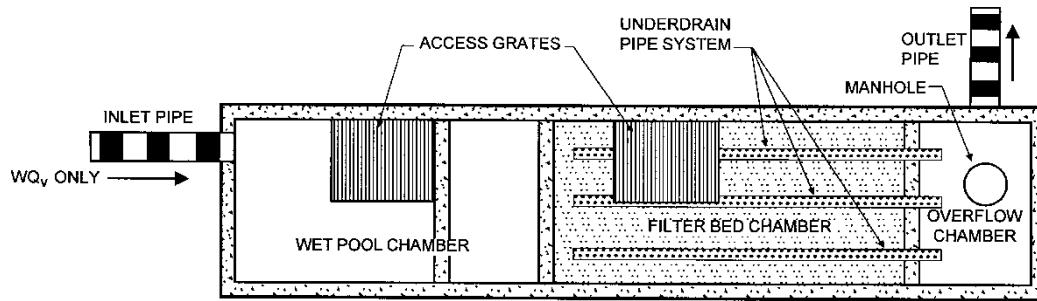

PLAN VIEW

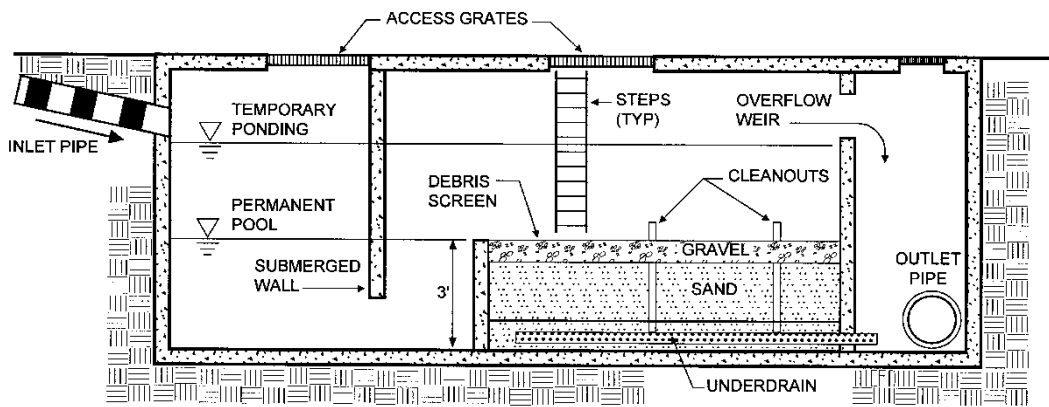

PROFILE

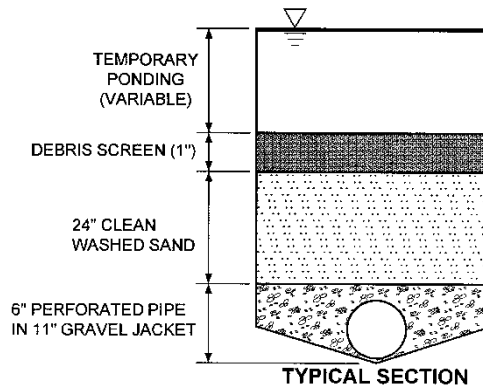

TYPICAL SECTION

New York State Stormwater Management Design Manual

Chapter 6: Performance Criteria

Section 6.4 Stormwater Filtering Systems

Figure 6.17 Perimeter Sand Filter (F-3)

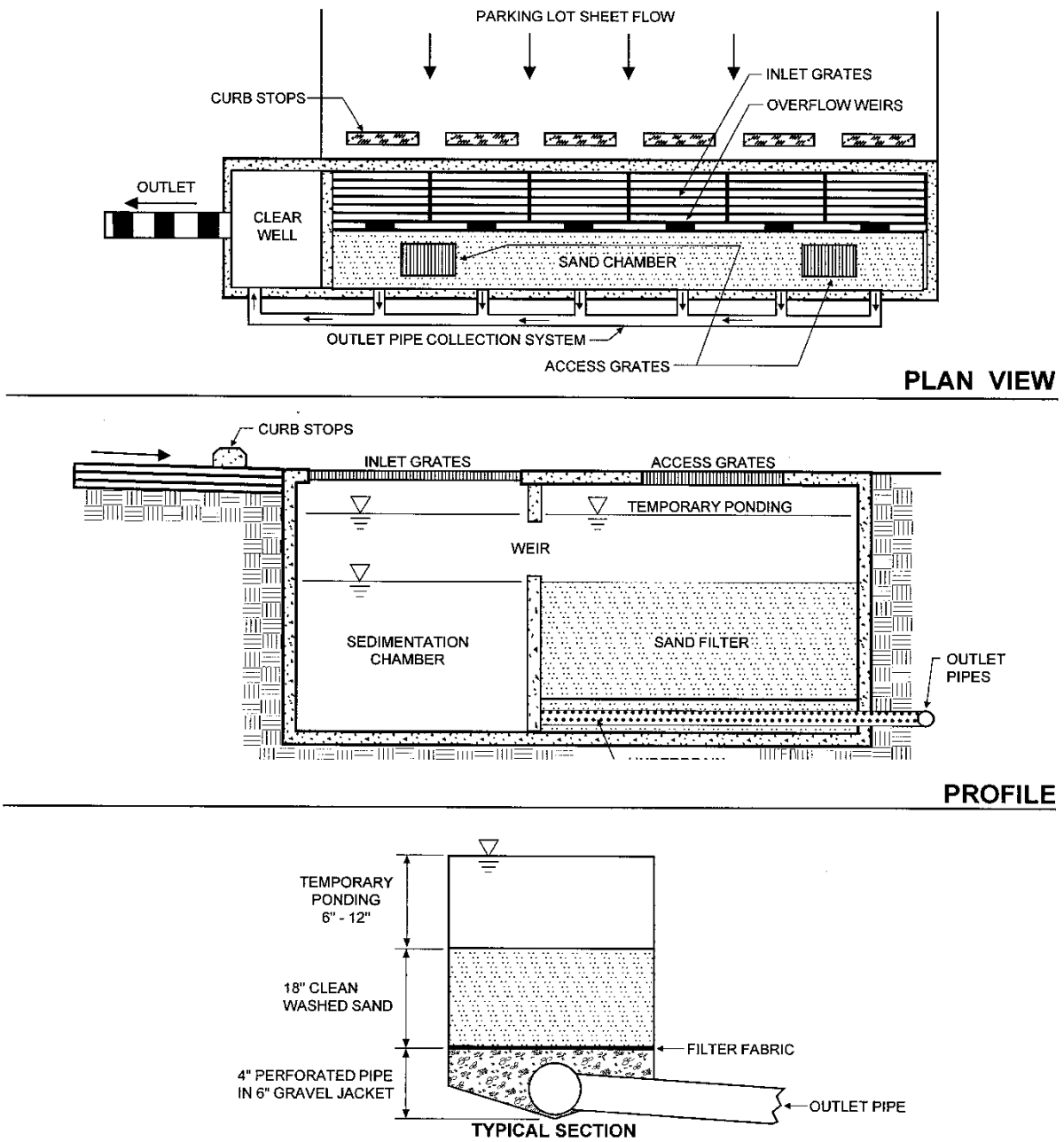

New York State Stormwater Management Design Manual

Chapter 6: Performance Criteria

Section 6.4 Stormwater Filtering Systems

Figure 6.18 Organic Filter (F- 4)

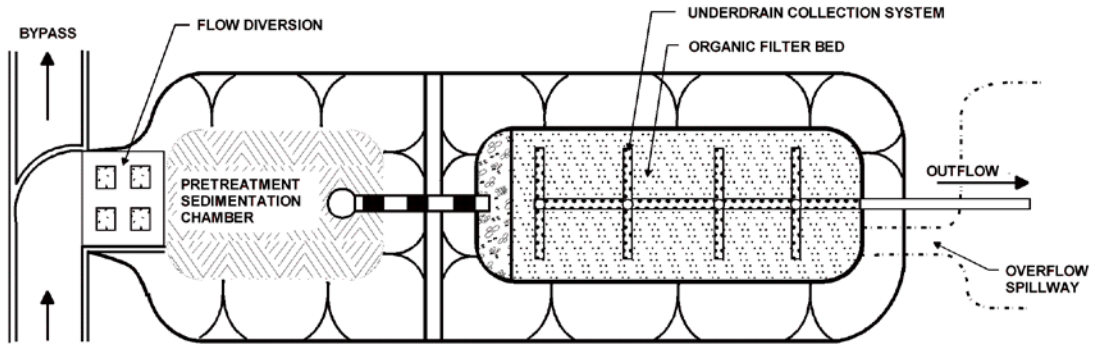

PLAN VIEW

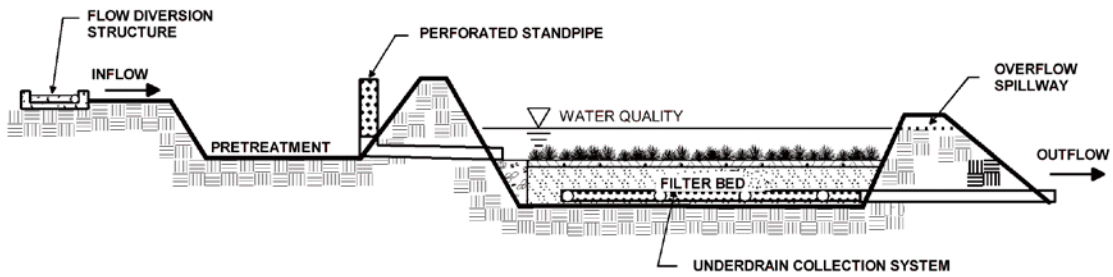

PROFILE

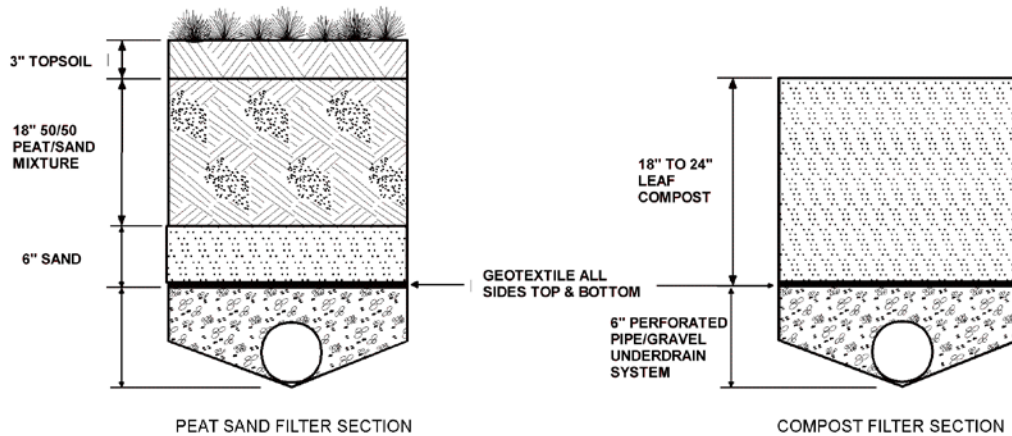

New York State Stormwater Management Design Manual

Chapter 6: Performance Criteria

Section 6.4 Stormwater Filtering Systems

Figure 6.19 Bioretention (F-5)

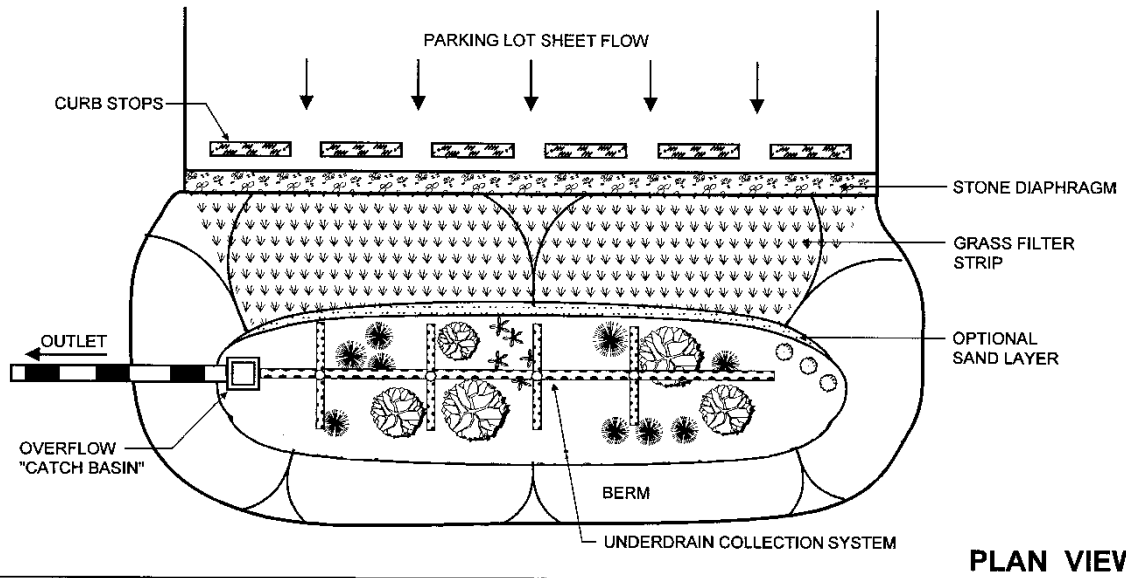

PLAN VIEW

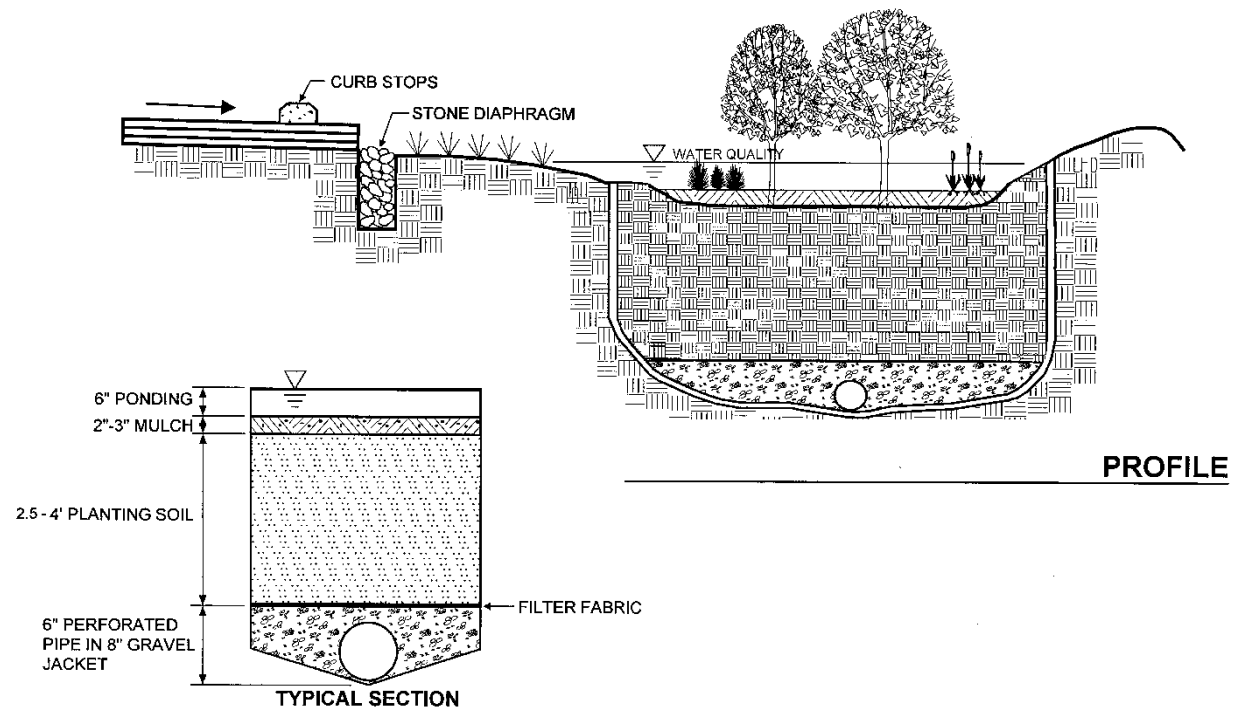

PROFILE

New York State Stormwater Management Design Manual

Chapter 6: Performance Criteria

Section 6.4 Stormwater Filtering Systems

6.4.1 Feasibility

Design Guidance

- Most stormwater filters require four to six feet of head, depending on site configuration and land area available. The perimeter sand filter (F-3), however, can be designed to function with as little as 18" to 24" of head.
- The recommended maximum contributing area to an individual stormwater filtering system is usually less than 10 acres. In some situations, larger areas may be acceptable.
- Sand and organic filtering systems are generally applied to land uses with a high percentage of impervious surfaces. Sites with imperviousness less than 75% will require full sedimentation pretreatment techniques.

6.4.2 Conveyance

Required Elements

- If runoff is delivered by a storm drain pipe or is along the main conveyance system, the filtering practice shall be designed off-line (see Appendix K).
- An overflow shall be provided within the practice to pass a percentage of the WQ_v to a stabilized water course. In addition, overflow for the ten-year storm shall be provided to a non-erosive outlet point (i.e., prevent downstream slope erosion).
- A flow regulator (or flow splitter diversion structure) shall be supplied to divert the WQ_v to the filtering practice, and allow larger flows to bypass the practice.
- Stormwater filters shall be equipped with a minimum 4" perforated pipe underdrain (6" is preferred) in a gravel layer. A permeable filter fabric shall be placed between the gravel layer and the filter media.
- Require a minimum 2' separation between the filter bottom and groundwater.

6.4.3 Pretreatment

Required Elements

- Dry or wet pretreatment shall be provided prior to filter media equivalent to at least 25% of the computed WQ_v . The typical method is a sedimentation basin that has a length to width ratio of 1.5:1. The Camp-Hazen equation is used to compute the required surface area for sand and organic filters requiring full sedimentation for pretreatment (WSDE, 1992) as follows:
- The required sedimentation basin area is computed using the following equation:

$$A_s = -1 * \left(\frac{Q_0}{W}\right) \ln(1 - E)$$

Where:

New York State Stormwater Management Design Manual

Chapter 6: Performance Criteria

Section 6.4 Stormwater Filtering Systems

A_s	=	Sedimentation basin surface area (ft ²)
E	=	sediment trap efficiency (use 90%)
W	=	particle settling velocity (ft/sec) use 0.0004 ft/sec for imperviousness (I) ≤ 75% use 0.0033 ft/sec for I > 75%
Q_o	=	Discharge rate from basin = (WQ _v /24 hr/3600s)
WQ _v	=	Water Quality Volume (cf)

This equation reduces to:

A_s	=	(0.066) (WQ _v) ft ² for I ≤ 75%
A_s	=	(0.0081) (WQ _v) ft ² for I > 75%

Design Guidance

- Adequate pretreatment for bioretention systems should incorporate all of the following: (a) grass filter strip below a level spreader or grass channel, (b) gravel diaphragm and (c) a mulch layer.
- The grass filter strip should be sized using the guidelines in Table 6.2.

Table 6.2 Guidelines for Filter Strip Pretreatment Sizing								
Parameter	Impervious Parking Lots				Residential Lawns			
Maximum Inflow Approach Length (ft.)	35		75		75		150	
Filter Strip Slope	≤2%	≥2%	≤2%	≥2%	≤2%	≥2%	≤2%	≥2%
Filter Strip Minimum Length	10'	15'	20'	25'	10'	12'	15'	18'

- The grass channel should be sized using the following procedure:
 - 1- Determine the channel length needed to treat the WQ_v, using sizing techniques described in the Grass Channel Fact Sheet (Chapter 5).
 - 2- Determine the volume directed to the channel for pretreatment
 - 3- Determine the channel length by multiplying the length determined in step 1 above by the ratio of the volume in step 2 to the WQ_v.

6.4.4 Treatment

New York State Stormwater Management Design Manual

Chapter 6: Performance Criteria

Section 6.4 Stormwater Filtering Systems

Required Elements

- The entire treatment system (including pretreatment) shall be sized to temporarily hold at least 75% of the WQ_v prior to filtration.
- The filter media shall consist of a medium sand (meeting ASTM C-33 concrete sand). Media used for organic filters may consist of peat/sand mix or leaf compost. Peat shall be a reed-sedge hemic peat.
- Bioretention systems shall consist of the following treatment components: A four foot deep planting soil bed, a surface mulch layer, and a six inch deep surface ponding area. Soils shall meet the design criteria outlined in Appendix H.

Design Guidance

- The filter bed typically has a minimum depth of 18". The perimeter filter may have a minimum filter bed depth of 12".
- The filter area for sand and organic filters should be sized based on the principles of Darcy's Law. A coefficient of permeability (k) should be used as follows:

Sand:	3.5 ft/day (City of Austin 1988)
Peat:	2.0 ft/day (Galli 1990)
Leaf compost:	8.7 ft/day (Claytor and Schueler, 1996)
Bioretention Soil:	0.5 ft/day (Claytor and Schueler, 1996)

The required filter bed area is computed using the following equation

$$A_f = \frac{WQ_v d_f}{k(h_f + d_f)t_f}$$

Where:

A_f	=	Surface area of filter bed (ft ²)
WQ_v	=	Water Quality Volume(cf)
d_f	=	Filter bed depth (ft)
k	=	Coefficient of permeability of filter media (ft/day)
h_f	=	Average height of water above filter bed (ft)
t_f	=	Design filter bed drain time (days) (1.67 days or 40 hours is recommended maximum t_f for sand filters, two days for bioretention)

6.4.5 Landscaping

Required Elements

New York State Stormwater Management Design Manual

Chapter 6: Performance Criteria

Section 6.4 Stormwater Filtering Systems

- A dense and vigorous vegetative cover shall be established over the contributing pervious drainage areas before runoff can be accepted into the facility.
- Landscaping is critical to the performance and function of bioretention areas. Therefore, a landscaping plan must be provided for bioretention areas.

Design Guidance

- Surface filters can have a grass cover to aid in pollutant adsorption. The grass should be capable of withstanding frequent periods of inundation and drought.
- Planting recommendations for bioretention facilities are as follows:
 - Native plant species should be specified over non-native species.
 - Vegetation should be selected based on a specified zone of hydric tolerance.
 - A selection of trees with an understory of shrubs and herbaceous materials should be provided.
 - Woody vegetation should not be specified at inflow locations.
 - Trees should be planted primarily along the perimeter of the facility.
 - A tree density of approximately one tree per 100 square feet (i.e., 10 feet on-center) is recommended. Shrubs and herbaceous vegetation should generally be planted at higher densities (five feet on-center and 2.5 feet on center, respectively).

6.4.6 Maintenance

Required Elements

- A legally binding and enforceable maintenance agreement shall be executed between the facility owner and the local review authority to ensure the following:
 - Sediment shall be cleaned out of the sedimentation chamber when it accumulates to a depth of more than six inches. Vegetation within the sedimentation chamber shall be limited to a height of 18 inches. The sediment chamber outlet devices shall be cleaned/repared when drawdown times exceed 36 hours. Trash and debris shall be removed as necessary.
 - Silt/sediment shall be removed from the filter bed when the accumulation exceeds one inch. When the filtering capacity of the filter diminishes substantially (i.e., when water ponds on the surface of the filter bed for more than 48 hours), the top few inches of discolored material shall be removed and shall be replaced with fresh material. The removed sediments shall be disposed in an acceptable manner (i.e., landfill).
- A stone drop (pea gravel diaphragm) of at least six inches shall be provided at the inlet of bioretention facilities (F-6). Areas devoid of mulch shall be re-mulched on an annual basis. Dead or diseased plant material shall be replaced.

Design Guidance

New York State Stormwater Management Design Manual

Chapter 6: Performance Criteria

Section 6.4 Stormwater Filtering Systems

- Organic filters or surface sand filters that have a grass cover should be mowed a minimum of three times per growing season to maintain maximum grass heights less than 12 inches.

6.4.7 Cold Climate Design Considerations

In cold climates, stormwater filtering systems need to be modified to protect the systems from freezing and frost heaving. The primary cold climate concerns to address with regards to filtering systems are:

- Freezing of the filter bed
- Pipe freezing
- Clogging of filter

NOTE

ALTHOUGH FILTERING SYSTEMS ARE NOT AS EFFECTIVE DURING THE WINTER, THEY ARE OFTEN EFFECTIVE AT TREATING STORM EVENTS IN AREAS WHERE OTHER SMPS ARE NOT PRACTICAL, SUCH AS IN HIGHLY URBANIZED REGIONS. THUS, THEY MAY BE A GOOD DESIGN OPTION, EVEN IF WINTER FLOWS CANNOT BE TREATED. IT IS ALSO IMPORTANT TO REMEMBER THAT THESE SMPS ARE DESIGNED FOR HIGHLY IMPERVIOUS AREAS. IF THE SNOW FROM THEIR CONTRIBUTING AREAS IS TRANSPORTED TO ANOTHER AREA, SUCH AS A PERVIOUS INFILTRATION AREA, A PRACTICE'S PERFORMANCE DURING THE WINTER SEASON MAY BE LESS CRITICAL TO OBTAIN WATER QUALITY GOALS.

Freezing of the Filter Bed

- Place filter beds for underground filter below the frost line to prevent the filtering medium from freezing during the winter.
- Discourage organic filters using peat and compost media, which are ineffective during the winter in cold climates. These organic filters retain water, and consequently can freeze solid and become completely impervious during the winter.
- Combine treatment with another SMP option that can be used as a backup to the filtering system to provide treatment during the winter when the filter is ineffective

Pipe Freezing

- Use a minimum 8" underdrain diameter in a 1' gravel bed. Increasing the diameter of the underdrain makes freezing less likely, and provides a greater capacity to drain standing water from the filter. The porous gravel bed prevents standing water in the system by promoting drainage. Gravel is also less susceptible to frost heaving than finer grained media.

New York State Stormwater Management Design Manual

Chapter 6: Performance Criteria

Section 6.4 Stormwater Filtering Systems

- Replace standpipes with weirs, which can be “frost free.” Although weir structures will not always provide detention, they can provide retention storage (i.e., storage with a permanent pool) in the pretreatment chamber.

Clogging of Filter with Excess Sand from Runoff

- If a filter is used to treat runoff from a parking lot or roadway that is frequently sanded during snow events, there is a high potential for clogging from sand in runoff. In these cases, the size of the pretreatment chamber should be increased to 40% of the treatment volume. For bioretention systems, a grass strip, such as a swale, of at least twenty-five feet in length should convey flow to the system.
- Filters should always be inspected for sand build-up in the filter chamber following the spring melt event

New York State Stormwater Management Design Manual

Chapter 6: Performance Criteria
 Section 6.4 Stormwater Filtering Systems

Sand/Organic Filters



Description: Multi-chamber structure designed to treat stormwater runoff through filtration, using a sediment forebay, a primary filter media and, typically, an underdrain collection system.

Design Variations: Surface Sand Filter (F-1), Underground Sand Filter (F-2), Perimeter Sand Filter (F-3), Organic Sand Filter (F-4)

<p style="text-align: center;"><u>KEY CONSIDERATIONS</u></p> <p>CONVEYANCE</p> <ul style="list-style-type: none"> • If stormwater is delivered by stormdrain, design off-line. • Overflow shall be provided to pass a fraction of the WQ_v to a stabilized watercourse. • Overflow for the ten-year storm to a non-erosive point. • Flow regulator needed to divert WQ_v to the practice, and bypass larger flows. • Underdrain (4" perforated pipe minimum; 6" preferred) <p>PRETREATMENT</p> <ul style="list-style-type: none"> • Pretreatment volume of 25% of WQ_v. • Typically a sediment basin with a 1.5:1 L:W ratio, sized with the Camp-Hazen equation (See Section 6.4.3) <p>TREATMENT</p> <ul style="list-style-type: none"> • System must hold 75% of the WQ_v • Filter media shall be ASTM C-33 sand for sand filters • Organic filters shall be a peat/sand mix, or leaf compost. • Peat shall be reed-sedge hemic peat <p>LANDSCAPING</p> <ul style="list-style-type: none"> • Contributing area stabilized before runoff is directed to the facility <p>MAINTENANCE REQUIREMENTS:</p> <ul style="list-style-type: none"> • Legally binding maintenance agreement. • Sediment cleaned out of sedimentation chamber when it reaches more than 6" in depth. • Vegetation height limited to 18" • Sediment chamber cleaned if drawdowns exceed 36 hours. 	<p style="text-align: center;"><u>STORMWATER MANAGEMENT SUITABILITY</u></p> <p><input checked="" type="checkbox"/> Water Quality</p> <p><input type="checkbox"/> Channel Protection</p> <p><input type="checkbox"/> Overbank Flood Protection</p> <p><input type="checkbox"/> Extreme Flood Protection</p> <p>Accepts Hotspot Runoff: <i>Yes</i> <i>(requires impermeable liner)</i></p> <p style="text-align: center;"><u>IMPLEMENTATION CONSIDERATIONS</u></p> <p><input type="checkbox"/> Capital Cost</p> <p><input type="checkbox"/> Maintenance Burden</p> <p><u>Residential</u> Subdivision Use: <i>No</i></p> <p>High Density/Ultra-Urban: <i>Yes</i></p> <p>Drainage Area: <i>2-10 acres max.</i></p> <p>Soils: <i>No restrictions</i></p> <p>Other Considerations: Typically needs to be combined with other controls to provide water quantity control</p> <p style="text-align: center;">Key: L=Low M=Moderate H=High</p> <p style="text-align: center;"><u>POLLUTANT REMOVAL</u></p> <p><input type="checkbox"/> Phosphorus</p>
--	---

New York State Stormwater Management Design Manual

Chapter 6: Performance Criteria

Section 6.4 Stormwater Filtering Systems

<ul style="list-style-type: none">• Trash and debris removal• Silt/sediment removed from filter bed after it reaches one inch.• If water ponds on the filter bed for greater than 48 hours, remove material, and replace.	<p>G Nitrogen</p> <p>G Metals - Cadmium, Copper, Lead, and Zinc removal</p> <p>F Pathogens - Coliform, Streptococci, E.Coli removal</p> <p>Key: G=Good F=Fair P=Poor</p>
---	--

New York State Stormwater Management Design Manual

Chapter 6: Performance Criteria

Section 6.4 Stormwater Filtering Systems

Bioretention Areas (F-5)



Description: Shallow stormwater basin or landscaped area which utilizes engineered soils and vegetation to capture and treat runoff. The practice is often located in parking lot islands, and can also be used to treat residential areas.

<u>KEY CONSIDERATIONS</u>	<u>STORMWATER MANAGEMENT SUITABILITY</u>
<p style="text-align: center;">CONVEYANCE</p> <ul style="list-style-type: none"> • Provide overflow for the 10-year storm to the conveyance system. • Conveyance to the system is typically overland flow delivered to the surface of the system, typically through curb cuts or over a concrete lip. <p style="text-align: center;">PRETREATMENT</p> <ul style="list-style-type: none"> • Pretreatment consists of a grass channel or grass filter strip, a gravel diaphragm, and a mulch layer, sized based on the methodologies described in Section 6.4.2. <p style="text-align: center;">TREATMENT</p> <ul style="list-style-type: none"> • Treatment area should have a four foot deep planting soil bed, a surface mulch layer, and a 6" ponding layer. • Size the treatment area using equations provided in Chapter 6. <p style="text-align: center;">LANDSCAPING</p> <ul style="list-style-type: none"> • Detailed landscaping plan required. <p style="text-align: center;">MAINTENANCE</p> <ul style="list-style-type: none"> • Inspect and repair/replace treatment area components • Stone drop (at least 6") provided at the inlet • Remulch annually 	<ul style="list-style-type: none"> <input checked="" type="checkbox"/> Water Quality <input type="checkbox"/> Channel Protection <input type="checkbox"/> Overbank Flood Protection <input type="checkbox"/> Extreme Flood Protection <p>Accepts Hotspot Runoff: <i>Yes</i> (requires impermeable liner)</p> <p style="text-align: center;"><u>IMPLEMENTATION CONSIDERATIONS</u></p> <ul style="list-style-type: none"> <input type="checkbox"/> Capital Cost <input type="checkbox"/> Maintenance Burden <p><u>Residential</u> Subdivision Use: <i>Yes</i></p> <p>High Density/Ultra-Urban: <i>Yes</i></p> <p>Drainage Area: <i>5 acres max.</i></p> <p>Soils: <i>Planting soils must meet specified criteria; No restrictions on surrounding soils</i></p> <p>Other Considerations:</p> <ul style="list-style-type: none"> • <i>Use of native plants is recommended</i>

New York State Stormwater Management Design Manual

Chapter 6: Performance Criteria

Section 6.4 Stormwater Filtering Systems

	<p>Key: L=Low M=Medium H=High</p> <p><u>POLLUTANT REMOVAL</u></p> <p>G Phosphorus</p> <p>G Nitrogen</p> <p>G Metals - Cadmium, Copper, Lead, and Zinc removal</p> <p>F Pathogens – Coliform, Streptococci, E.Coli removal</p> <p>Key: G=Good F=Fair P=Poor</p>
--	---

New York State Stormwater Management Design Manual

Chapter 6: Performance Criteria

Section 6.5 Open Channel Systems

Section 6.5 Open Channel Systems

Open channel systems are vegetated open channels that are explicitly designed to capture and treat the full WQ_v within dry or wet cells formed by check dams or other means. Design variants include:

- O-1 Dry Swale (Figure 6.20)
- O-2 Wet Swale (Figure 6.21)

Treatment Suitability: Open Channel Systems can meet water quality treatment goals only, and are not appropriate for Cp_v or Q_p .

New York State Stormwater Management Design Manual

Chapter 6: Performance Criteria

Section 6.5 Open Channel Systems

Figure 6.20 Dry Swale (O-1)

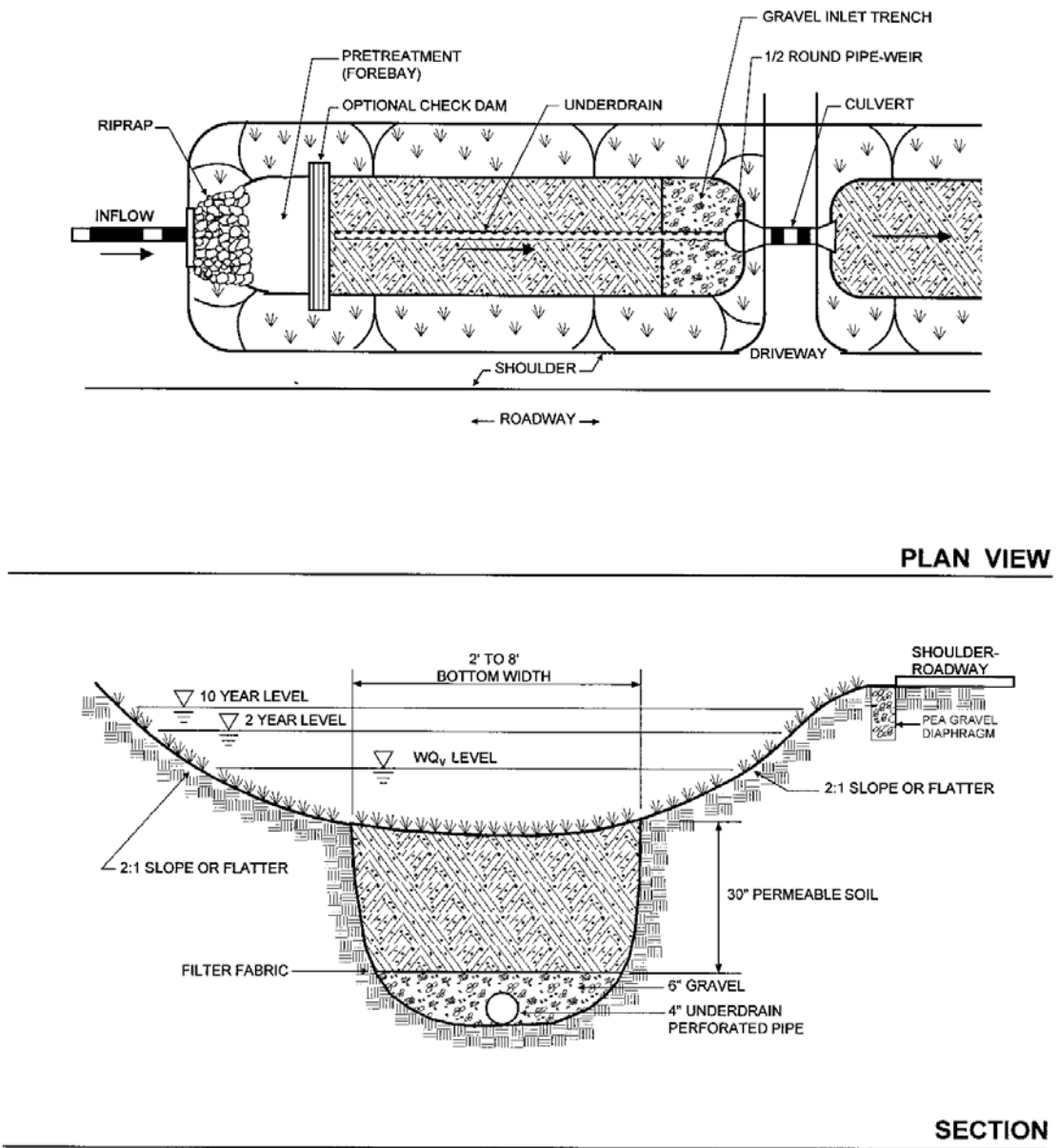

New York State Stormwater Management Design Manual

Chapter 6: Performance Criteria

Section 6.5 Open Channel Systems

Figure 6.21 Wet Swale (O-2)

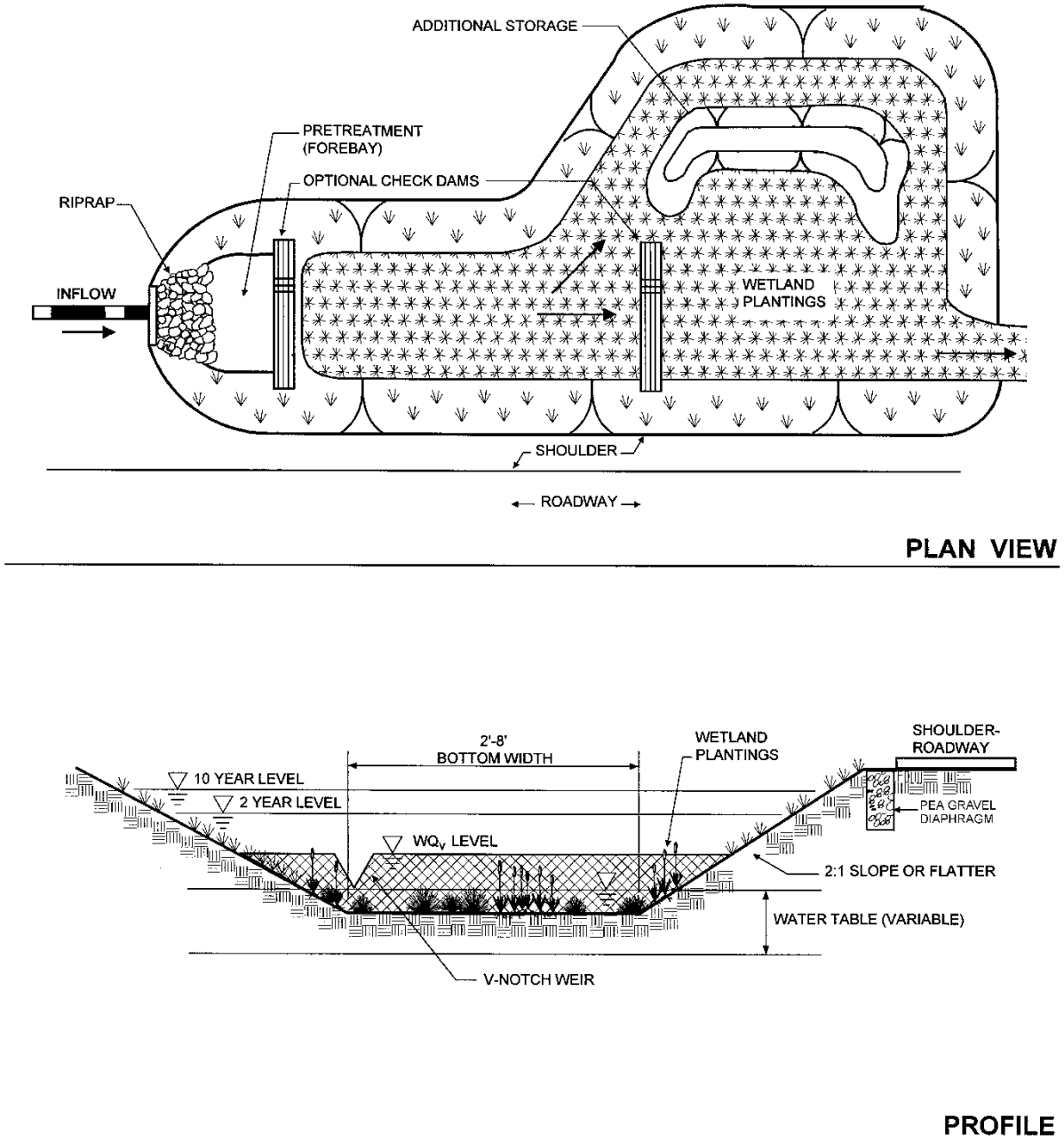

New York State Stormwater Management Design Manual

Chapter 6: Performance Criteria

Section 6.5 Open Channel Systems

6.5.1 Feasibility

Required Elements

- The system shall have a maximum longitudinal slope of 4.0%

Design Guidance

- Dry Swales (O-1) are primarily applicable for land uses such as roads, highways, residential development, and pervious areas.
- Wet Swales (O-2) should be restricted in residential areas because of the potential for stagnant water and other nuisance ponding.
- Provide a 2' separation distance from groundwater for O-1.

6.5.2 Conveyance

Required Elements

- The peak velocity for the two-year storm must be non-erosive (i.e., 3.5-5.0 fps). (See Appendix L for a table of erosive velocities for grass and soil).
- Open channels shall be designed to safely convey the ten-year storm with a minimum of 6 inches of freeboard. Note that some agencies or local municipalities may design channel to convey a different design storm.
- The maximum allowable temporary ponding time within a channel shall be less than 48 hours. An underdrain system shall be used in the dry swale to ensure this ponding time.
- Channels shall be designed with moderate side slopes (flatter than 3:1) for most conditions. 2:1 is the absolute maximum side slope.

Design Guidance

- Open channel systems which directly receive runoff from impervious surfaces may have a 6 inch (maximum) drop onto a protected shelf (pea gravel diaphragm) to minimize the clogging potential of the inlet.
- The underdrain system should be composed of a 6" gravel bed with a 4" PVC pipe.
- If the site slope is greater than 2%, check dams may be needed to retain the water quality volume within the swale system.

6.5.3 Pretreatment

Required Elements

New York State Stormwater Management Design Manual

Chapter 6: Performance Criteria

Section 6.5 Open Channel Systems

- Provide 10% of the WQ_v in pretreatment. This storage is usually obtained by providing checkdams at pipe inlets and/or driveway crossings.

Design Guidance

- Utilize a pea gravel diaphragm and gentle side slopes along the top of channels to provide pretreatment for lateral sheet flows.

6.5.4 Treatment

Required Elements

- Temporarily store the WQ_v within the facility to be released over a minimum 30 minute duration.
- Design with a bottom width no greater than eight feet to avoid potential gullyng and channel braiding, but no less than two feet.
- Soil media for the dry swale shall meet the specifications outlined in Appendix H.

Design Guidance

- Open channels should maintain a maximum ponding depth of one foot at the mid-point of the channel, and a maximum depth of 18" at the end point of the channel (for storage of the WQ_v).

6.5.5 Landscaping

Design Guidance

- Landscape design should specify proper grass species and wetland plants based on specific site, soils and hydric conditions present along the channel (see Appendix H for landscaping guidance for New York).

6.5.6 Maintenance

Required Elements

- A legally binding and enforceable maintenance agreement shall be executed between the facility owner and the local review authority to ensure the following:
- Sediment build-up within the bottom of the channel or filter strip is removed when 25% of the original WQ_v volume has been exceeded.
- Vegetation in dry swales is mowed as required during the growing season to maintain grass heights in the 4 to 6 inch range.

6.5.7 Cold Climate Design Considerations

For open channel systems, the primary cold climate design challenges that need to be addressed are:

New York State Stormwater Management Design Manual

Chapter 6: Performance Criteria

Section 6.5 Open Channel Systems

- Snowmelt infiltration on frozen ground
- Culvert freezing
- The impacts of deicers on channel vegetation.

Snowmelt Infiltration on Frozen Ground

- In order to ensure that the filter bed remains dry between storm events, increase the size of the underdrain pipe to a minimum diameter of 6" with a minimum 1' filter bed.
- The soil bed permeability of the dry swale should be NRCS class SM (NRCS, 1984), which is slightly higher than in the base criteria. This increased permeability will encourage snowmelt infiltration.

Culvert Freezing

- Use culvert pipes with a minimum diameter of 18".
- Design culverts with a minimum 1% slope where possible.

The Impacts of De-icers on Channel Vegetation

- Inspect open channel systems after the spring melt. At this time, residual sand should be removed and any damaged vegetation should be replaced.
- If roadside or parking lot runoff is directed to the practice, mulching may be required in the spring to restore soil structure and moisture capacity to reduce the impacts of deicing agents.
- Use salt-tolerant plant species in vegetated swales.
-

New York State Stormwater Management Design Manual

Chapter 6: Performance Criteria

Section 6.5 Open Channel Systems

Open Channels



Description: Vegetated channels that are explicitly designed and constructed to capture and treat stormwater runoff within dry or wet cells formed by check dams or other means.

Design Options: Dry Swale (O-1), Wet Swale (O-2)

<p style="text-align: center;"><u>KEY CONSIDERATIONS</u></p> <p>FEASIBILITY</p> <ul style="list-style-type: none"> Maximum longitudinal slope of 4% <p>CONVEYANCE</p> <ul style="list-style-type: none"> Non-erosive (3.5 to 5.0 fps) peak velocity for the 2-year storm Safe conveyance of the ten-year storm with a minimum of 6 inches of freeboard. Side slopes gentler than 2:1 (3:1 preferred). The maximum allowable temporary ponding time of 48 hours <p>PRETREATMENT</p> <ul style="list-style-type: none"> 10% of the WQ_v in pretreatment, usually provided using check dams at culverts or driveway crossings. <p>TREATMENT</p> <ul style="list-style-type: none"> Temporary storage the WQ_v within the facility to be released over a minimum 30 minute duration. Bottom width no greater than 8 feet, but no less than two feet. Soil media as detailed in Appendix H. <p>MAINTENANCE</p> <ul style="list-style-type: none"> Removal of sediment build-up within the bottom of the channel or filter strip when 25% of the original WQ_v volume has been exceeded. Maintain a grass height of 4" to 6" in dry swales. 	<p style="text-align: center;"><u>STORMWATER MANAGEMENT SUITABILITY</u></p> <p><input checked="" type="checkbox"/> Water Quality</p> <p><input type="checkbox"/> Channel Protection</p> <p><input type="checkbox"/> Overbank Flood Protection</p> <p><input type="checkbox"/> Extreme Flood Protection</p> <p>Accepts Hotspot Runoff: <i>Yes</i> <i>(requires impermeable liner)</i></p> <p style="text-align: center;"><u>IMPLEMENTATION CONSIDERATIONS</u></p> <p><input type="checkbox"/> Capital Cost</p> <p><input type="checkbox"/> Maintenance Burden</p> <p><u>Residential</u> Subdivision Use: <i>Yes</i></p> <p>High Density/Ultra-Urban: <i>No</i></p> <p>Drainage Area: <i>5 acres max.</i></p> <p>Soils: <i>No restrictions</i></p> <p>Other Considerations:</p> <ul style="list-style-type: none"> <i>Permeable soil layer (dry swale)</i> <i>Wetland plants (wet swale)</i> <p style="border: 1px solid black; padding: 2px;">Key: H=High M=Medium L=Low</p> <p style="text-align: center;"><u>POLLUTANT REMOVAL</u></p> <p><input type="checkbox"/> Phosphorus</p>
---	--

New York State Stormwater Management Design Manual

Chapter 6: Performance Criteria

Section 6.5 Open Channel Systems

	<p>F Nitrogen</p> <p>G Metals - Cadmium, Copper, Lead, and Zinc removal</p> <p>P Pathogens - Coliform, Streptococci, E.Coli removal</p> <p>Key: G=Good F=Fair P=Poor</p>
--	--

Chapter 7: SMP Selection

This chapter presents a series of matrices that can be used as a screening process to select the best SMP or group of SMPs for a development site. It also provides guidance for best locating practices on the site. The matrices presented can be used to screen practices in a step-wise fashion. The screening factors include:

1. Land Use
2. Physical Feasibility
3. Watershed/ Regional Factors
4. Stormwater Management Capability
5. Community and Environmental Factors

The five matrices presented here are not exhaustive. Specific additional criteria may be incorporated depending on local design knowledge and resource protection goals. Furthermore, many communities may wish to eliminate some of the selection factors presented in this section. Caveats for the application of each matrix are included in the detailed description of each.

More detail on the proposed step-wise screening process is provided below:

Step 1 Land Use

Which practices are best suited for the proposed land use at this site? In this step, the designer makes an initial screen to select practices that are best suited to a particular land use.

Step 2 Physical Feasibility Factors

Are there any physical constraints at the project site that may restrict or preclude the use of a particular SMP? In this step, the designer screens the SMP list using Matrix No. 2 to determine if the soils, water table, drainage area, slope or head conditions present at a particular development site might limit the use of a SMP.

Step 3 Watershed Factors

What watershed protection goals need to be met in the resource my site drains to? Matrix No.3 outlines SMP goals and restrictions based on the resource being protected.

Step 4 Stormwater Management Capability

Can one SMP meet all design criteria, or is a combination of practices needed? In this step, designers can screen the SMP list using Matrix No. 4 to determine if a particular SMP can meet water quality, channel protection, and flood control storage requirements. At the end of this step, the designer can screen the SMP options down to a manageable number and determine if a single SMP or a group of SMPs is needed to meet stormwater sizing criteria at the site.

Step 5 Community and Environmental Factors

Do the remaining SMPs have any important community or environmental benefits or drawbacks that might influence the selection process? In this step, a matrix is used to compare the SMP options with regard to cold climate restrictions, maintenance, habitat, community acceptance, cost and other environmental factors.

New York State Stormwater Management Design Manual

Chapter 7: SMP Selection

Section 7.1 Land Use

Section 7.1 Land Use

This matrix allows the designer to make an initial screen of practices most appropriate for a given land use (Table 7.1).

Rural. This column identifies SMPs that are best suited to treat runoff in rural or very low density areas (e.g., typically at a density of less than ½ dwelling unit per acre).

Residential. This column identifies the best treatment options in medium to high density residential developments.

Roads and Highways. This column identifies the best practices to treat runoff from major roadways and highway systems.

Commercial Development. This column identifies practices that are suitable for new commercial development

Hotspot Land Uses. This last column examines the capability of an SMP to treat runoff from designated hotspots (see Appendix A). An SMP that receives hotspot runoff may have design restrictions, as noted.

Ultra-Urban Sites. This column identifies SMPs that work well in the ultra-urban environment, where space is limited and original soils have been disturbed. These SMPs are frequently used at redevelopment sites.

New York State Stormwater Management Design Manual

Chapter 7: SMP Selection

Section 7.1 Land Use

Table 7.1 Land Use Selection Matrix							
SMP Group	SMP Design	Rural	Residential	Roads and Highways	Commercial/ High Density	Hotspots	Ultra Urban
Pond	Micropool ED	○	○	○	◐	①	●
	Wet Pond	○	○	○	◐	①	●
	Wet ED Pond	○	○	○	◐	①	●
	Multiple Pond	○	○	◐	◐	①	●
	Pocket Pond	○	◐	○	◐	●	●
Wetland	Shallow Wetland	○	○	◐	◐	①	●
	ED Wetland	○	○	◐	◐	①	●
	Pond/Wetland	○	○	●	◐	①	●
	Pocket Wetland	○	◐	○	◐	●	●
Infiltration	Infiltration Trench	◐	◐	○	○	●	◐
	Shallow I-Basin	◐	◐	◐	◐	●	◐
	Dry Well ¹	◐	○	●	◐	●	◐
Filters	Surface Sand Filter	●	◐	○	○	②	○
	Underground SF	●	●	◐	○	○	○
	Perimeter SF	●	●	◐	○	○	○
	Organic SF	●	◐	○	○	②	○
	Bioretention	◐	◐	○	○	②	○
Open Channels	Dry Swale	○	◐	○	◐	②	◐
	Wet Swale	○	●	○	●	●	●
<p>○: Yes. Good option in most cases. ◐: Depends. Suitable under certain conditions, or may be used to treat a portion of the site. ●: No. Seldom or never suitable. ①: Acceptable option, but may require a pond liner to reduce risk of groundwater contamination.</p>							

New York State Stormwater Management Design Manual

Chapter 7: SMP Selection

Section 7.2 Physical Feasibility Factors

Section 7.2 Physical Feasibility Factors

This matrix allows the designer to evaluate possible options based on physical conditions at the site (Table 7.2). More detailed testing protocols are often needed to confirm physical conditions at the site. Five primary factors are:

Soils. The key evaluation factors are based on an initial investigation of the NRCS hydrologic soils groups at the site. Note that more detailed geotechnical tests are usually required for infiltration feasibility and during design to confirm permeability and other factors. Appendix H describes geotechnical testing requirements for New York State.

Water Table. This column indicates the minimum depth to the seasonally high water table from the bottom elevation, or floor, of an SMP.

Drainage Area. This column indicates the minimum or maximum drainage area that is considered optimal for a practice. If the drainage area present at a site is slightly greater than the maximum allowable drainage area for a practice, some leeway is warranted where a practice meets other management objectives. Likewise, the minimum drainage areas indicated for ponds and wetlands should not be considered inflexible limits, and may be increased or decreased depending on water availability (baseflow or groundwater), mechanisms employed to prevent clogging, or the ability to assume an increased maintenance burden.

Slope. This column evaluates the effect of slope on the practice. Specifically, the slope guidance refers to how flat the area where the practice is installed must be and/or how steep the contributing drainage area or flow length can be.

Head. This column provides an estimate of the elevation difference needed for a practice (from the inflow to the outflow) to allow for gravity operation.

New York State Stormwater Management Design Manual

Chapter 7: SMP Selection

Section 7.2 Physical Feasibility Factors

Table 7.2 Physical Feasibility Matrix						
SMP Group	SMP Design	Soils	Water Table	Drainage Area (acres)	Site Slope	Head (ft)
Pond	Micropool ED	HSG A soils may require pond liner.	2 foot separation if hotspot or aquifer	10 min ¹	No more than 15%	6 to 8 ft
	Wet Pond			25 min ¹		
	Wet ED Pond					
	Multiple Pond					
	Pocket Pond	OK	below WT	5 max ²		4 ft
Wetland	Shallow Wetland	HSG A soils may require liner	2 foot separation if hotspot or aquifer	25 min	No more than 8%	3 to 5 ft
	ED Wetland					
	Pond/Wetland					
	Pocket Wetland	OK	below WT	5 max		2 to 3 ft
Infiltration	Infiltration Trench	f _c > 0.5 inch/hr; additional pretreatment required over 2.0 in/hr (See Section 6.3.3)	3 feet, 4 feet if sole source aquifer.	5 max	No more than 15%	1 ft ⁶
	Shallow I-Basin			10 max ³		3 ft
	Dry Well			1 max ⁴		1 ft
Filters	Surface SF	OK	2 feet ⁵	10 max ²	No more than 6%	5 ft
	Underground SF			2 max ²		5 to 7ft
	Perimeter SF			2 max ²		2 to 3 ft
	Organic SF			5 max ²		2 to 4 ft
	Bioretention			5 max ²		5 ft
Open Channels	Dry Swale	Made Soil	2 feet	5 max	No more than 4%	3-5 ft
	Wet Swale	OK	below WT	5 max		1 ft
<p>Notes:</p> <ol style="list-style-type: none"> 1: Unless adequate water balance and anti-clogging device installed 2: Drainage area can be larger in some instances 3: May be larger in areas where the soil percolation rate is greater than 5.0 in/hr 4: Designed to treat rooftop runoff only 5: If designed with a permeable bottom, must meet the depth requirements for infiltration practices. 6: Required ponding depth above geotextile layer. 						

Section 7.3 Watershed/Regional Factors

The choices made by the designer should be influenced to some extent by the resource being protected, and the region of New York State where the site is located. The following matrices (Tables 7.3a and 7.3b) present some design considerations for six watershed or regional factors in New York:

Sensitive Streams. The guidance presented here should apply to all trout waters and Class N waters, and any streams that support high biodiversity and water quality, and have a low density of development.

Aquifers. In sole source aquifers, special care should be taken to select practices and incorporate design considerations that protect the groundwater quality. Figure 7.1 depicts sole source aquifers in the State of New York.

Figure 7.1 Sole Source Aquifers in New York State

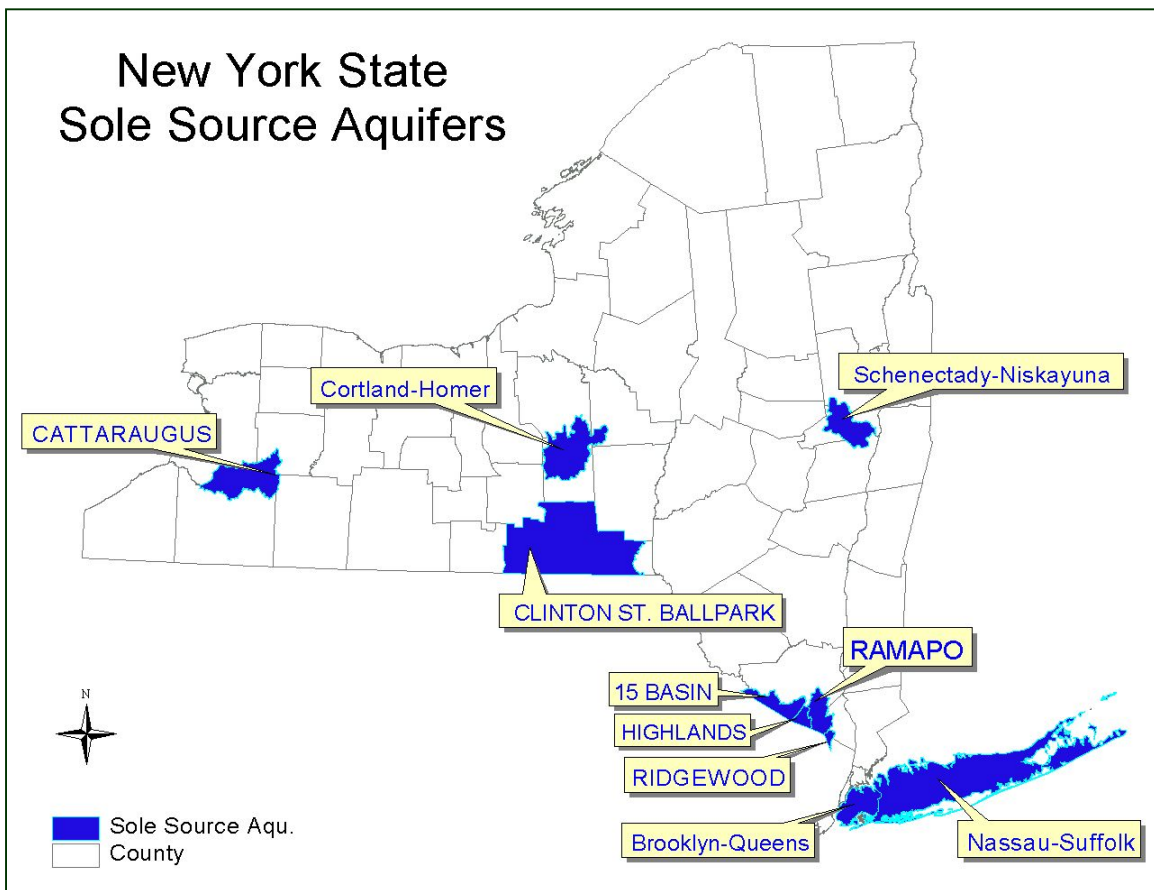

Lakes. Lakes are of particular concern in New York, which has many natural lake systems and borders on two Great Lakes. The information in this matrix focuses on phosphorous removal, which is an important

New York State Stormwater Management Design Manual

Chapter 7: SMP Selection

Section 7.3 Watershed/Regional Factors

concern in most lake systems. It is important to note, however, that many lakes in New York State have other important issues to address. Some lakes, such as Onondaga Lake, have other specific concerns, such as toxics and metals. Each community should also take these goals into consideration when reviewing site plans.

Table 7.3a Watershed/ Regional Selection Matrix-1			
SMP Group	Sensitive Stream	Aquifer	Lakes
Ponds	Emphasize channel protection. Restrict in-stream practices. In trout waters, minimize permanent pool area, and encourage shading.	May require liner if HSG A soils are present. Pretreat 100% of WQ _v from hotspots.	Encourage the use of a large permanent pool to improve phosphorus removal.
	Wetlands	Require channel protection. Restrict in-stream practices. Restrict use in trout waters.	
Infiltration	Strongly encourage use for groundwater recharge. Combine with a detention facility to provide channel protection.	Provide 100' horizontal separation distance from wells and 4' vertical distance from the water table.	OK. Provides high phosphorus removal.
Filtering Systems	Combine with a detention facility to provide channel protection.	Excellent pretreatment for infiltration or open channel practices.	OK, but designs with a submerged filter may result in phosphorus release.
Open Channels	Combine with a detention facility to provide channel protection.	OK, but hotspot runoff must be adequately pretreated	OK. Moderate P removal.

Reservoirs. For drinking water reservoirs, and in particular for unfiltered water supplies such as the New York City Reservoir system, turbidity, phosphorous removal, and bacteria are of particular concern. A particular reservoir may have other specific concerns, which should be identified as part of a Source Water Assessment.

Estuary/Coastal. In New York State, coastal or estuary areas include the South Shore Estuary Reserve, Peconic Estuary, NY/NJ Harbor, and Hudson River Estuary. In these areas, nitrogen is typically a concern due to potential eutrophication. In addition, bacteria control is important to protect shellfish beds.

Cold Climates. Many portions of New York State experience cold or very snowy winters. This matrix summarizes some of the design considerations in these cold climate areas. For more detailed information, consult Chapter 6, which provides cold climate design guidance for each group of SMPs.

New York State Stormwater Management Design Manual

Chapter 7: SMP Selection

Section 7.3 Watershed/Regional Factors

Table 7.3b Watershed/Regional Selection Matrix-2			
SMP Group	Reservoir	Estuary/Coastal	Cold Climates
Ponds	Encourage the use of a large permanent pool to improve sediment and phosphorous removal. Promote long detention times to encourage bacteria removal.	Encourage long detention times to promote bacteria removal. Provides high nitrogen removal. In flat coastal areas, a pond drain may not be feasible.	Incorporate design features to improve winter performance.
Wetlands			Encourage the use of salt-tolerant vegetation.
Infiltration	Provide a separation distance from bedrock and water table Pretreat runoff prior to infiltration practices.	OK, but provide a separation distance to seasonally high groundwater. In the sandy soils typical of coastal areas, additional pretreatment may be required (See Section 6.3.3)	Incorporate features to minimize the risk of frost heave. Discourage infiltration of chlorides.
Filtering Systems	Excellent pretreatment for infiltration or open channel practices. Moderate to high coliform removal	Moderate to high coliform removal Designs with a submerged filter bed appear to have very high nitrogen removal	Incorporate design features to improve winter performance.
Open Channels	Poor coliform removal for wet swales.	Poor coliform removal for grass wet swales.	Encourage the use of salt-tolerant vegetation.

New York State Stormwater Management Design Manual

Chapter 7: SMP Selection

Section 7.4 Stormwater Management Capability

Section 7.4 Stormwater Management Capability

This matrix examines the capability of each SMP option to meet stormwater management criteria (Table 7.4). It shows whether an SMP can meet requirements for:

Water Quality. The matrix summarizes the relative pollutant removal of each practice for nitrogen, metals, and bacteria. All of the practices approved for water quality achieve at least 80% TSS and 40% TP removal. For more detailed information, consult Appendix A, which describes the application of the Simple Method in New York State. Pollutant removals are based on a comprehensive pollutant removal database produced by the Center for Watershed Protection (Winer, 2000).

Channel Protection. The matrix indicates whether the SMP can typically provide channel protection storage. The finding that a particular SMP cannot meet the channel protection requirement does not necessarily imply that the SMP should be eliminated from consideration, but is a reminder that more than one practice may be needed at a site (e.g., a bioretention area and a downstream ED pond).

Flood Control. The matrix shows whether an SMP can typically meet the overbank flooding criteria for the site. Again, the finding that a particular SMP cannot meet the requirement does not necessarily mean that it should be eliminated from consideration, but rather is a reminder that more than one practice may be needed at a site (e.g., a bioretention area and a downstream stormwater detention pond).

New York State Stormwater Management Design Manual

Chapter 7: SMP Selection

Section 7.4 Stormwater Management Capability

TABLE 7.4 STORMWATER MANAGEMENT CAPABILITY MATRIX

SMP Group	SMP Design	Water Quality			Channel Protection	Flood Control
		Nitrogen	Metals	Bacteria		
Pond	Micropool ED				○	○
	Wet Pond				○	○
	Wet ED Pond	○	○	○	○	○
	Multiple Pond				○	○
	Pocket Pond				○	○
Wetland	Shallow Wetland				○	○
	ED Wetland	○	◐	○	○	○
	Pond/Wetland				○	○
	Pocket Wetland				○	①
Infiltration	Infiltration Trench				●	●
	Shallow I-Basin	○	○	○	②	②
	Dry Well				●	●
Filters	Surface Sand Filter				①	●
	Underground SF				●	●
	Perimeter SF	○	○	◐	●	●
	Organic SF				●	●
	Bioretention				①	●
Open Channels	Dry Swale	◐	○	●	●	●
	Wet Swale				●	●

○: Good option for meeting management goal
 Good pollutant removal (>30% TN, >60% Metals, >70% Bacteria)

◐: Fair pollutant removal (15-30% TN, 30-60% Metals, 35-70% Bacteria)

●: Cannot meet management goal.
 Poor pollutant removal (<15% TN, <30 Metals, <35% Bacteria)

①: In most cases, cannot meet this goal, but the design may be adapted to add storage.

②: Generally cannot meet this goal, except in areas with soil percolation rates greater than 5.0 in/hr

New York State Stormwater Management Design Manual

Chapter 7: SMP Selection

Section 7.5 Community and Environmental Factors

Section 7.5 Community and Environmental Factors

The last step assesses community and environmental factors involved in SMP selection. This matrix employs a comparative index approach (Table 7.5.). An open circle indicates that the SMP has a high benefit and a dark circle indicates that the particular SMP has a low benefit.

Ease of Maintenance. This column assesses the relative maintenance effort needed for an SMP, in terms of three criteria: frequency of scheduled maintenance, chronic maintenance problems (such as clogging) and reported failure rates. It should be noted that **all SMPs** require routine inspection and maintenance.

Community Acceptance. This column assesses community acceptance, as measured by three factors: market and preference surveys, reported nuisance problems, and visual orientation (i.e., is it prominently located or is it in a discrete underground location). It should be noted that a low rank can often be improved by a better landscaping plan.

Affordability. The SMPs are ranked according to their relative construction cost per impervious acre treated.

Safety. A comparative index that expresses the relative safety of an SMP. An open circle indicates a safe SMP, while a darkened circle indicates deep pools may create potential safety risks. The safety factor is included at this stage of the screening process because liability and safety are of paramount concern in many residential settings.

Habitat. SMPs are evaluated on their ability to provide wildlife or wetland habitat, assuming that an effort is made to landscape them appropriately. Objective criteria include size, water features, wetland features and vegetative cover of the SMP and its buffer.

New York State Stormwater Management Design Manual

Chapter 7: SMP Selection

Section 7.5 Community and Environmental Factors

Table 7.5 Community and Environmental Factors Matrix						
SMP Group	SMP List	Ease of Maintenance	Community Acceptance	Affordability	Safety	Habitat
Ponds	Micropool ED	●	●	○	○	●
	Wet Pond	○	○	○	●	○
	Wet ED Pond	○	○	○	●	○
	Multiple Pond	○	○	●	●	○
	Pocket Pond	●	●	○	●	●
Wetlands	Shallow Wetland	●	○	●	○	○
	ED Wetland	●	●	●	●	○
	Pond/Wetland	○	○	●	●	○
	Pocket Wetland	●	●	○	○	●
Infiltration	Infiltration Trench	●	○	●	○	●
	Shallow I-Basin	●	●	●	○	●
	Dry Well	●	●	●	○	●
Filters	Surface SF	●	●	●	○	●
	Underground SF	●	○	●	●	●
	Perimeter SF	●	○	●	○	●
	Organic SF	●	○	●	○	●
	Bioretention	●	●	●	○	●
Open Channels	Dry Swale	○	○	●	○	●
	Wet Swale	○	●	○	○	●

Note: ○ High, ● Moderate, ● Low

Chapter 8: Stormwater Management Design Examples

This chapter presents design examples for two hypothetical development sites in the State of New York. The first site, “Stone Hill Estates,” is a residential development near Ithaca. The second is a commercial site in Albany. The chapter is divided into five sections, each of which focuses on a particular element of stormwater management design.

- Section 8.1 provides an example of detailed hydrology calculations at the residential site.
- Section 8.2 presents a pond design example based on the hydrology calculated in Section 8.1. This design example demonstrates the hydrologic and hydraulic computations to achieve water quality and water quantity control for stormwater management. Other specific dam design criteria such as soil compaction, structural appurtenances, embankment drainage, outlet design, gates, reservoir drawdown requirements, etc. are stated in Guidelines For Design of Dams.
- This design example in Section 8.2 requires an Article 15 Permit from NYS-DEC since the dam is 15 feet high measured from the top of dam to the low elevation at the downstream outlet, and the storage measured behind the structure to the top of the dam is 2.2 MG.
- Sections 8.3 through 8.5 present design examples for three practices on the commercial site: a sand filter, infiltration trench, and bioretention practice.

Section 8.1 Sizing Example - Stone Hill Estates

Following is a sizing example for the hypothetical “Stone Hill Estates,” a 45-acre residential development in Ithaca, New York (Figure 8.1). The site also drains approximately 20 acres of off-site drainage, which is currently in a meadow condition. The site is on mostly C soils with some D soils.

Figure 8.1 Stone Hill Site Plan

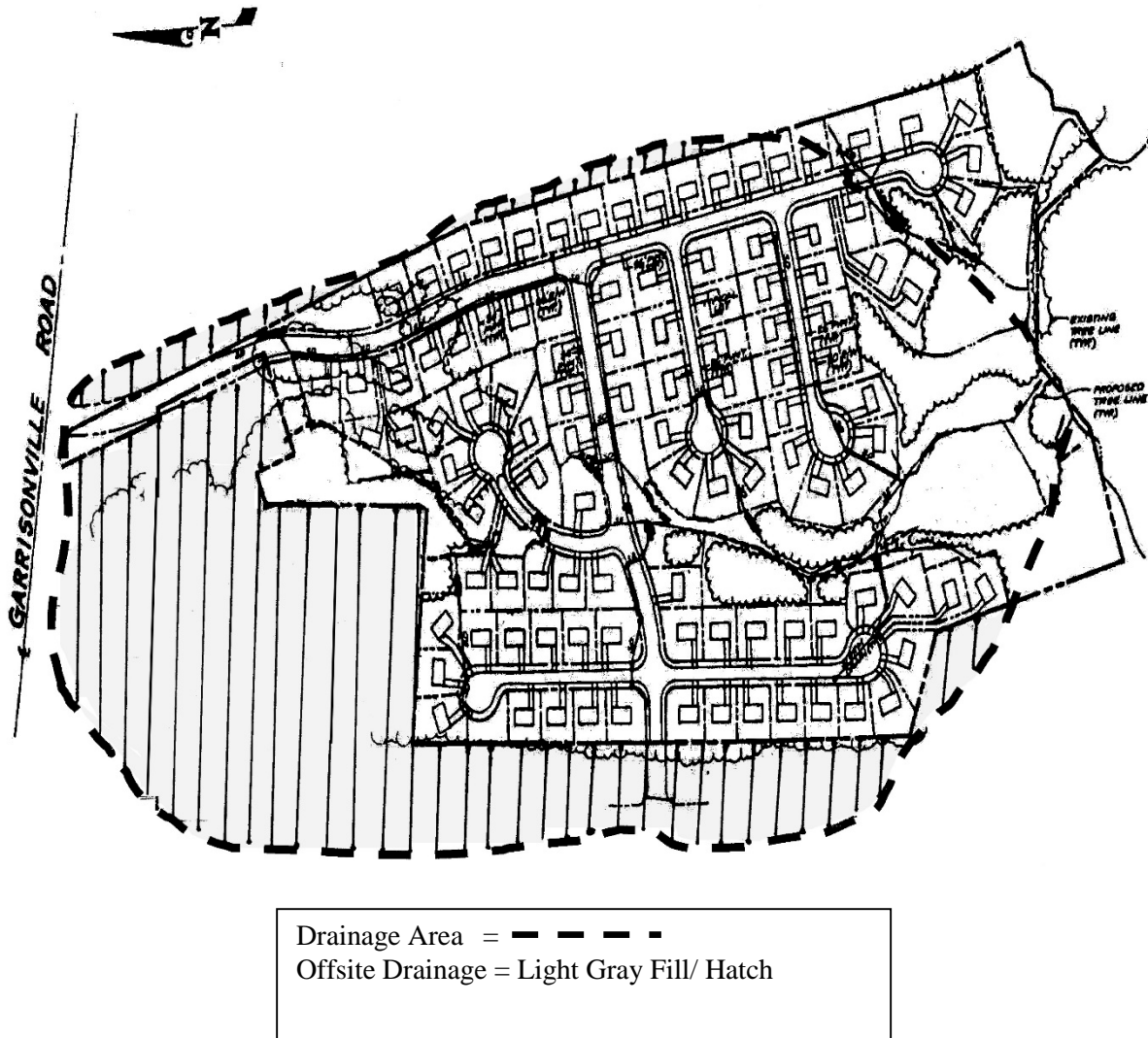

Hydrologic Data

	<u>Pre</u>	<u>Post</u>	<u>Ult.</u>
CN	72	78	82
t_c (hr)	0.46	0.35	0.35

Base Data

Location: Ithaca, NY
 Site Area = 45.1 ac; Offsite Area = 20.0 ac (meadow)
 Total Drainage Area (A) = 65.1
 Measured Impervious Area=12.0 ac;

Site Soils Types: 78% “C”, 22% “D”

Offsite Soil Type: 100% “C”

Zoning: Residential (½ acre lots)

Hazard Class: Low “A”, Dam Size small per table #1 Appendix A.

Computation of Preliminary Stormwater Storage Volumes and Peak Discharges

The layout of the Stone Hill subdivision is shown on the previous page.

Water Quality Volume, WQ_v

- Compute Impervious Cover

Use both on-site and off-site drainage:

$$I = 12.0 \text{ acres} / 65.1 \text{ acres}$$

$$= 18.4\%$$

- Compute Runoff Coefficient, R_v

$$R_v = 0.05 + (I) (0.009)$$

$$= 0.05 + (18.4) (0.009) = 0.22$$

- Compute WQ_v (Includes both on-site and off-site drainage)

Use the 90% capture rule with 0.9” of rainfall. (From Figure 4.1)

$$WQ_v = (0.9”) (R_v) (A)$$

$$= (0.9”) (0.22) (65.1 \text{ ac}) (1\text{ft}/12\text{in})$$

$$= \underline{1.07 \text{ ac-ft}}$$

Establish Hydrologic Input Parameters and Develop Site Hydrology (see Figures 8.2, 8.3, and 8.4)

Condition	Area	CN	Tc
	Ac		hrs
Pre-developed	65.1	72	0.46
Post-developed	65.1	78	0.35
Ultimate buildout*	65.1	82	0.35

*Zoned land use in the drainage area.

Hydrologic Calculations

Condition	Q _{1-yr}	Q _{1-yr}	Q _{10-yr}	Q _{100-yr}
Runoff	inches	cfs	cfs	cfs
Pre-developed	0.4	19	72	141
Post-developed	0.7	38	112	202
Ultimate buildout	NA	NA	NA	227

Figure 8.3 Stone Hill Post-Development Conditions

PEAK DISCHARGE SUMMARY				
JOB: STONE HILL				EWB 21-Jan-97
DRAINAGE AREA NAME: POST DEVELOPMENT				
COVER DESCRIPTION	SOIL NAME	GROUP A,B,C,D	Curve Number	AREA (In acres)
MEADOW		C	71	0.16 Ac.
MEADOW		D	78	0.14 Ac.
WOOD		C	70	3.09 Ac.
WOOD		D	77	1.81 Ac.
IMPERVIOUS			98	12.00 Ac.
GRASS		C	74	20.09 Ac.
GRASS		D	80	7.81 Ac.
OFFSITE MEADOW		C	71	20.00 Ac.
AREA SUBTOTALS:				65.10 Ac.
Time of Concentration	Surface Cover	Manning 'n'	Flow Length	Slope
2-Yr 24 Hr Rainfall = 2.7 In	Cross Section	Wetted Per	Avg Velocity	Tt (Hrs)
Sheet Flow	dense grass	'n'=0.24	100 Ft.	3.80% 0.20 Hrs
Shallow Flow (a)	UNPAVED		100 Ft. 1.98 F.P.S.	1.50% 0.01 Hrs.
(b)	PAVED		400 Ft. 2.03 F.P.S.	1.00% 0.05 Hrs.
Channel Flow (a)		'n'=0.013	1550 Ft. 7.22 F.P.S.	1.00% 0.06 Hrs.
Hydraulic Radius =0.50	1.6 SqFt	3.2 Ft.		
(b)		'n'=0.030	350 Ft. 13.01 F.P.S.	4.30% 0.01 Hrs.
Hydraulic Radius =1.42	12.0 SqFt	8.5 Ft.		
(c)		'n'=0.040	300 Ft. 7.89 F.P.S.	3.30% 0.01 Hrs.
Hydraulic Radius =1.26	22.0 SqFt	8.5 Ft.		
Total Area in Acres =	65.10 Ac.	Total Sheet	Total Shallow	Total Channel
Weighted CN =	78	Flow=	Flow=	Flow =
Time Of Concentration =	0.35 Hrs.	0.20 Hrs.	0.07 Hrs.	0.08 Hrs.
Pond Factor =	1	RAINFALL TYPE II		
STORM	Precipitation (P) inches	Runoff (Q)in	Qp, PEAK DISCHARGE	TOTAL STORM Volumes
1 Year	2.3 In.	0.66 In.	37.6 CFS	156,283 Cu. Ft.
2 Year	2.7 In.	0.92 In.	54.0 CFS	217,511 Cu. Ft.
10 Year	3.9 In.	1.8 In.	112 CFS	427,155 Cu. Ft.
100 Year	5.5 In.	3.14 In.	202 CFS	742,265 Cu. Ft.

Figure 8.4 Stone Hill Ultimate Buildout Conditions

PEAK DISCHARGE SUMMARY					
JOB: STONE HILL					EWB 21-Jan-97
DRAINAGE AREA NAME: ULTIMATE BUILDOUT					
COVER DESCRIPTION	SOIL NAME	GROUP A,B,C,D	Curve Number	AREA (In acres)	
MEADOW		C	71	0.16 Ac.	
MEADOW		D	78	0.14 Ac.	
WOOD		C	70	3.09 Ac.	
WOOD		D	77	1.81 Ac.	
IMPERVIOUS			98	12.00 Ac.	
GRASS		C	74	20.09 Ac.	
GRASS		D	80	7.81 Ac.	
OFFSITE ULTIMATE SF RES (0.25 AC LOTS)		C	83	20.00 Ac.	
		AREA SUBTOTALS:		65.10 Ac.	
Time of Concentration	Surface Cover	Manning 'n'	Flow Length	Slope	
2-Yr 24 Hr Rainfall = 2.7 In	Cross Section	Wetted Per	Avg Velocity	Tt (Hrs)	
Sheet Flow	dense grass	'n'=0.24	100 Ft.	3.80% 0.20 Hrs	
Shallow Flow (a)	UNPAVED		100 Ft. 1.98 F.P.S.	1.50% 0.01 Hrs.	
(b)	PAVED		400 Ft. 2.03 F.P.S.	1.00% 0.05 Hrs.	
Channel Flow (a)		'n'=0.013	1550 Ft.	1.00%	
Hydraulic Radius =0.50	1.6 SqFt	3.2 Ft	7.22 F.P.S.	0.06 Hrs.	
(b)		'n'=0.030	350 Ft.	4.30%	
Hydraulic Radius =1.42	12.0 SqFt	8.5 Ft	13.01 F.P.S.	0.01 Hrs.	
(c)		'n'=0.040	300 Ft.	3.30%	
Hydraulic Radius =1.26	22.0 SqFt	8.5 Ft	7.89 F.P.S.	0.01 Hrs.	
Total Area in Acres =	65.10 Ac.	Total Sheet	Total Shallow	Total Channel	
Weighted CN =	82	Flow=	Flow=	Flow =	
Time Of Concentration =	0.35 Hrs.	0.20 Hrs.	0.07 Hrs.	0.08 Hrs.	
Pond Factor =	1	RAINFALL TYPE II			
STORM	Precipitation (P) inches	Runoff (Q)	Qp, PEAK DISCHARGE	TOTAL STORM Volumes	
1 Year	2.3 In.	0.85 In.	50.9 CFS	201,772 Cu. Ft.	
2 Year	2.7 In.	1.15 In.	70.0 CFS	271,097 Cu. Ft.	
10 Year	3.9 In.	2.12 In.	135 CFS	500,458 Cu. Ft.	
100 Year	5.5 In.	3.52 In.	227 CFS	834,167 Cu. Ft.	

Compute Stream Channel Protection Volume, (C_{pv}) (see Section 4.3 and Appendix B)

For stream channel protection, provide 24 hours of extended detention (T) for the one-year event.

Compute Channel Protection Storage Volume

First, determine the value of the unit peak discharge (q_u) using TR-55 and Type II Rainfall Distribution

- Initial abstraction (I_a) for CN of 78 is 0.564: [$I_a = (200/CN - 2)$]
- $I_a/P = (0.564)/ 2.3 \text{ inches} = 0.245$
- $T_c = 0.35 \text{ hours}$
- Using the above data and Exhibit 4-II from TR-55 (NRCS, 1986), $q_u = 570 \text{ csm/in}$ (cubic feet per second per square mile per year)
- Knowing q_u and $T = 24 \text{ hours}$, find q_o/q_i using Figure 8.5 (also see methodology in Appendix B)
- Peak outflow discharge/peak inflow discharge (q_o/q_i) = 0.035
- $V_s/V_r = 0.683 - 1.43(q_o/q_i) + 1.64(q_o/q_i)^2 - 0.804(q_o/q_i)^3$ (from Appendix B)
Where V_s equals channel protection storage (C_{pv}) and V_r equals the volume of runoff in inches.

Figure 8.5 Detention Time vs. Discharge Ratios (Source: MDE, 2000)

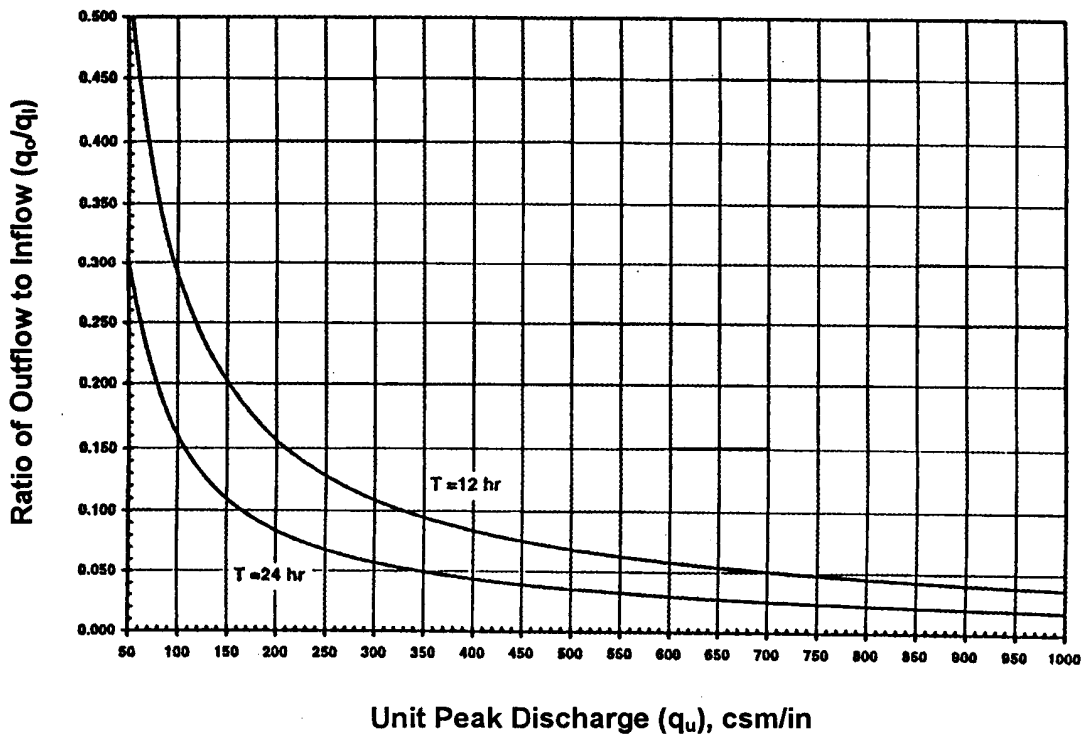

- $V_s/V_r = 0.63$ and, from figure 8.3, $Q = 0.7''$
- Solving for V_s

$$V_s = C_{p_v} = 0.63(0.7'')(1/12)(65.1 \text{ ac}) = 2.4 \text{ ac-ft (104,214 cubic feet)}$$

Define the Average Release Rate

- The above volume, 2.4 ac-ft, is to be released over 24 hours
- $(2.4 \text{ ac-ft} \times 43,560 \text{ ft}^2/\text{ac}) / (24 \text{ hrs} \times 3,600 \text{ sec/hr}) = 1.2 \text{ cfs}$

Compute Overbank Flood Protection Volume, ($Q_{p_{10}}$) (see Section 4.4)

For both the overbank flood protection volume and the extreme flood protection volume, size is determined using the TR-55 “Short-Cut Method,” which relates the storage volume to the required reduction in peak flow and storm inflow volume (Figure 8.6).

- For a q_i of 112 cfs (post-developed), and an allowable q_o of 72 cfs (pre-developed), the value of $(q_o)/(q_i)$ is 0.64
- Using figure 8.6, and a post-developed curve number of 78, $V_s/V_r = 0.23$
- Using a total storm runoff volume of 427,155 cubic feet (9.8 acre-feet), the required storage (V_s) is:

$$V_s = Q_{p_v} = 0.23(427,155)/43,560 = 2.26 \text{ acre-feet}$$

While the TR-55 short-cut method reports to incorporate multiple stage structures, experience has shown that an additional 10-15% storage is required when multiple levels of extended detention are provided inclusive with the 10-year storm. So, for preliminary sizing purposes add 15% to the required volume for the 10-year storm. $Q_{p-10} = 2.23 \times 1.15 = 2.59 \text{ ac-ft}$.

While the TR-55 short-cut method reports to incorporate multiple stage structures, experience has shown that an additional 10-15% storage is required when multiple levels of extended detention are provided inclusive with the 10-year storm. So, for preliminary sizing purposes, add 15% to the required volume for the 10-year storm. $Q_{p-10} = 2.23 \times 1.15 = 2.59 \text{ ac-ft}$.

Figure 8.6 Approximate Detention Basin Routing for Rainfall Types I, IA, II, and III
 Source: TR-55, 1986

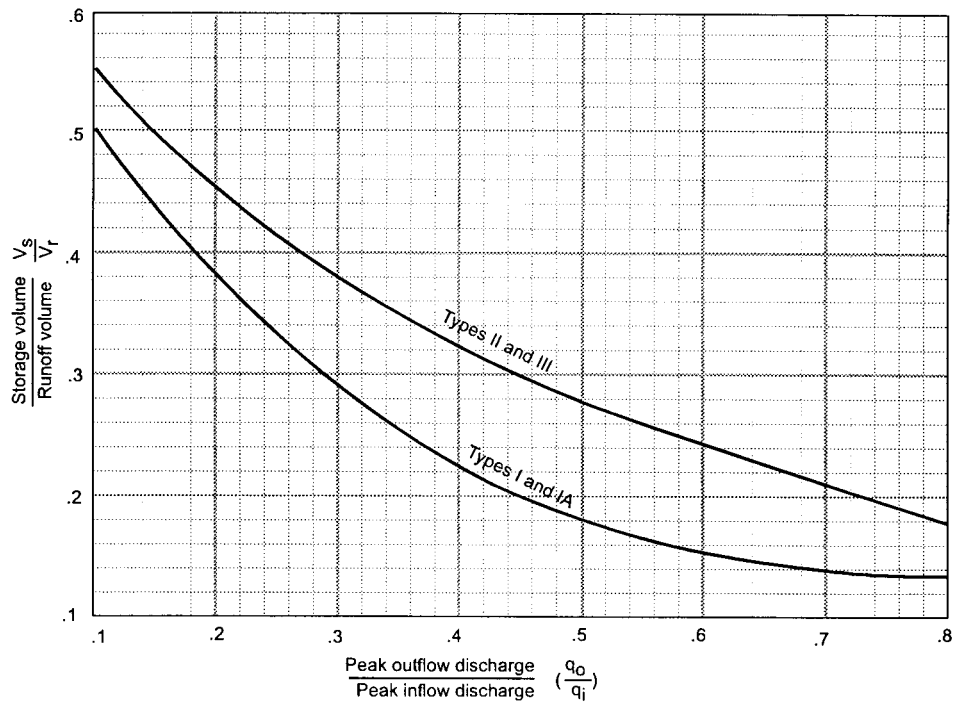

Compute Extreme Flood Protection Volume, (Q_f)

Extreme flood protection is calculated using the same methodology as overbank protection.

- For a Q_{in} of, and an allowable Q_{out} of, and a runoff volume of the V_s necessary for 100-year control is, under a developed CN of 78. Note that 5.5 inches of rain fall during this event, with approximately 3.1 inches of runoff.
- While the TR-55 short-cut method reports to incorporate multiple stage structures, experience has shown that an additional 10-15% storage is required when multiple levels of extended detention are provided inclusive with the 100-year storm. So, for preliminary sizing purposes add 15% to the required volume for the 100-year storm. $Q_{f-100} = 3.53 \times 1.15 = 4.06$ ac-ft.

Analyze Safe Passage of 100-Year Design Storm (Q_f)

If peak discharge control of the 100-year storm is not required, it is still necessary to provide safe passage for the 100-year event under ultimate buildout conditions ($Q_{ult} = 227$ cfs). See table 4-1 appendix A for low and moderate hazard dam design storm.

Section 8.2 Pond Design Example

Following is a step-by-step design example for an extended detention pond (P-3) applied to Stone Hill Estates, which is described in detail in Section 8.1 along with design treatment volumes. This example continues with the design to develop actual design parameters for the constructed facility.

Step 1. Compute preliminary runoff control volumes.

The volume requirements were determined in Section 8.1. Table 8.1 provides a summary of the storage requirements.

Table 8.1. Summary of General Storage Requirements for Stone Hill Estates

Symbol	Category	Volume Required (ac- ft)	Notes
WQ _v	Water Quality Volume	1.07	
Cp _v	Stream Protection	2.4	Average ED release rate is 1.2 cfs over 24 hours
Q _p	Peak Control	2.6	10-year, in this case
Q _f	Flood Control	4.1	

Step 2. Determine if the development site and conditions are appropriate for the use of a stormwater pond.

The drainage area to the pond is 65.1 acres. Existing ground at the proposed pond outlet is 619 MSL. Soil boring observations reveal that the seasonally high water table is at elevation 618. The underlying soils are SC (sandy clay) and are suitable for earthen embankments and to support a wet pond without a liner. The stream invert at the adjacent stream is at elevation 616.

Step 2A. Determine Hazardous Class of Dam.

The height of the dam, its maximum impoundment capacity, the physical characteristics of the dam site and the effect that a failure of the dam would have upon human life, residences, buildings, roads, highways, utilities and other facilities should be assessed to determine whether a low (A), moderate (B) or high (C) hazard classification is appropriate for designing the dam. Refer to Section 3.0 of the "Guidelines for the

Design of Dams" for additional information regarding hazard class and Table 1 of those guidelines for the appropriate hydrologic design criteria for new dams based on the assigned hazard class and size.

Step 3. Confirm local design criteria and applicability.

There are no additional requirements for this site.

Step 4. Determine pretreatment volume.

Size wet forebay to treat 10% of the WQ_v . $(10\%)(1.07 \text{ ac-ft}) = \mathbf{0.1 \text{ ac-ft}}$

(forebay volume is included in WQ_v as part of permanent pool volume)

Step 5. Determine permanent pool volume and ED volume.

Size permanent pool volume to contain 50% of WQ_v :

$0.5 \times (1.07 \text{ ac-ft}) = \mathbf{0.54 \text{ ac-ft}}$. (includes 0.1 ac-ft of forebay volume)

Size ED volume to contain 50% of WQ_v : $0.5 \times (1.07 \text{ ac-ft}) = \mathbf{0.54 \text{ ac-ft}}$

NOTE:

THIS DESIGN APPROACH ASSUMES THAT ALL OF THE ED VOLUME WILL BE IN THE POND AT ONCE. WHILE THIS WILL NOT BE THE CASE, SINCE THERE IS A DISCHARGE DURING THE EARLY STAGES OF STORMS, THIS CONSERVATIVE APPROACH ALLOWS FOR ED CONTROL OVER A WIDER RANGE OF STORMS, NOT JUST THE TARGET RAINFALL.

Step 6. Determine pond location and preliminary geometry. Conduct pond grading and determine storage available for WQ_v permanent pool and WQ_v -ED if applicable.

This step involves initially grading the pond (establishing contours) and determining the elevation-storage relationship for the pond. Storage must be provided for the permanent pool (including sediment forebay), extended detention (WQ_v -ED), Cp_v -ED, 10-year storm, 100-year storm, plus sufficient additional storage to pass the ultimate condition 100-year storm with required freeboard. An elevation-storage table and curve

is prepared using the average area method for computing volumes. See Figure 8.7 for pond location on site, Figure 8.8 for grading and Figure 8.9 for Elevation-Storage Data.

Figure 8.7 Pond Location on Site

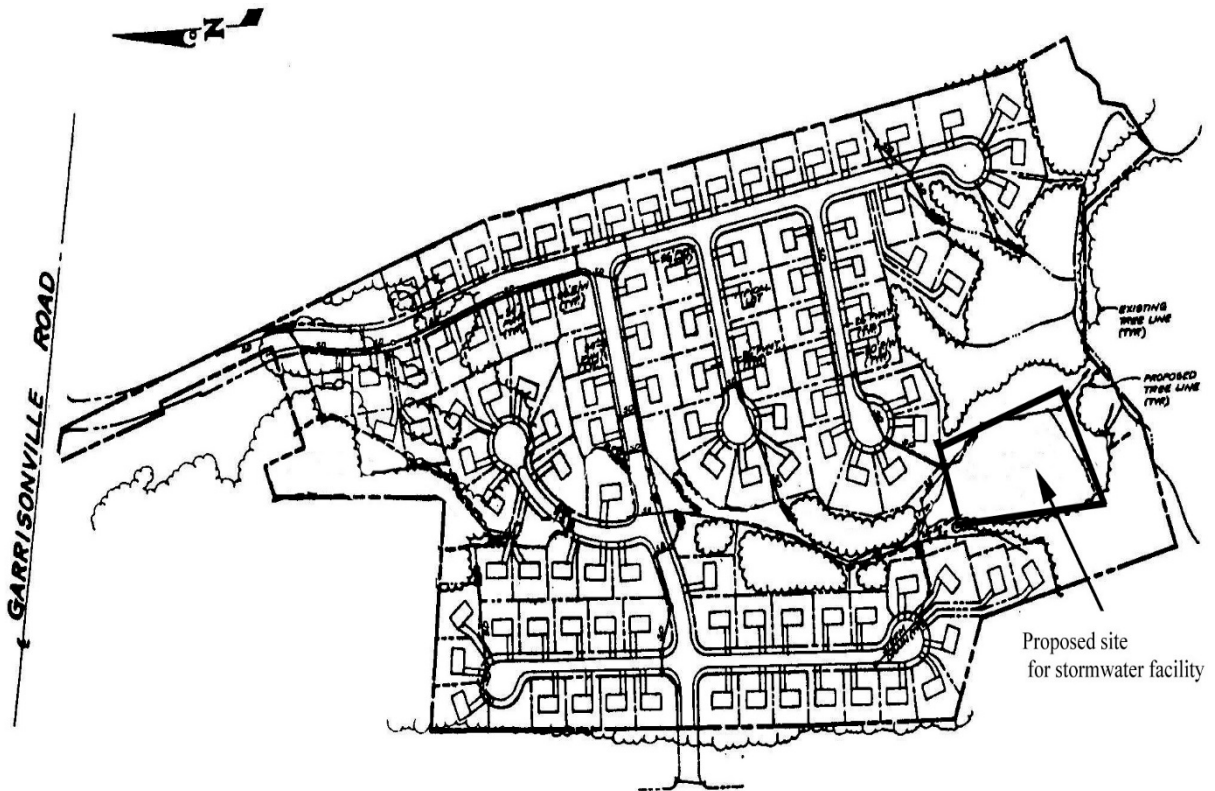

Figure 8.8 Plan View of Pond Grading (Not to Scale)

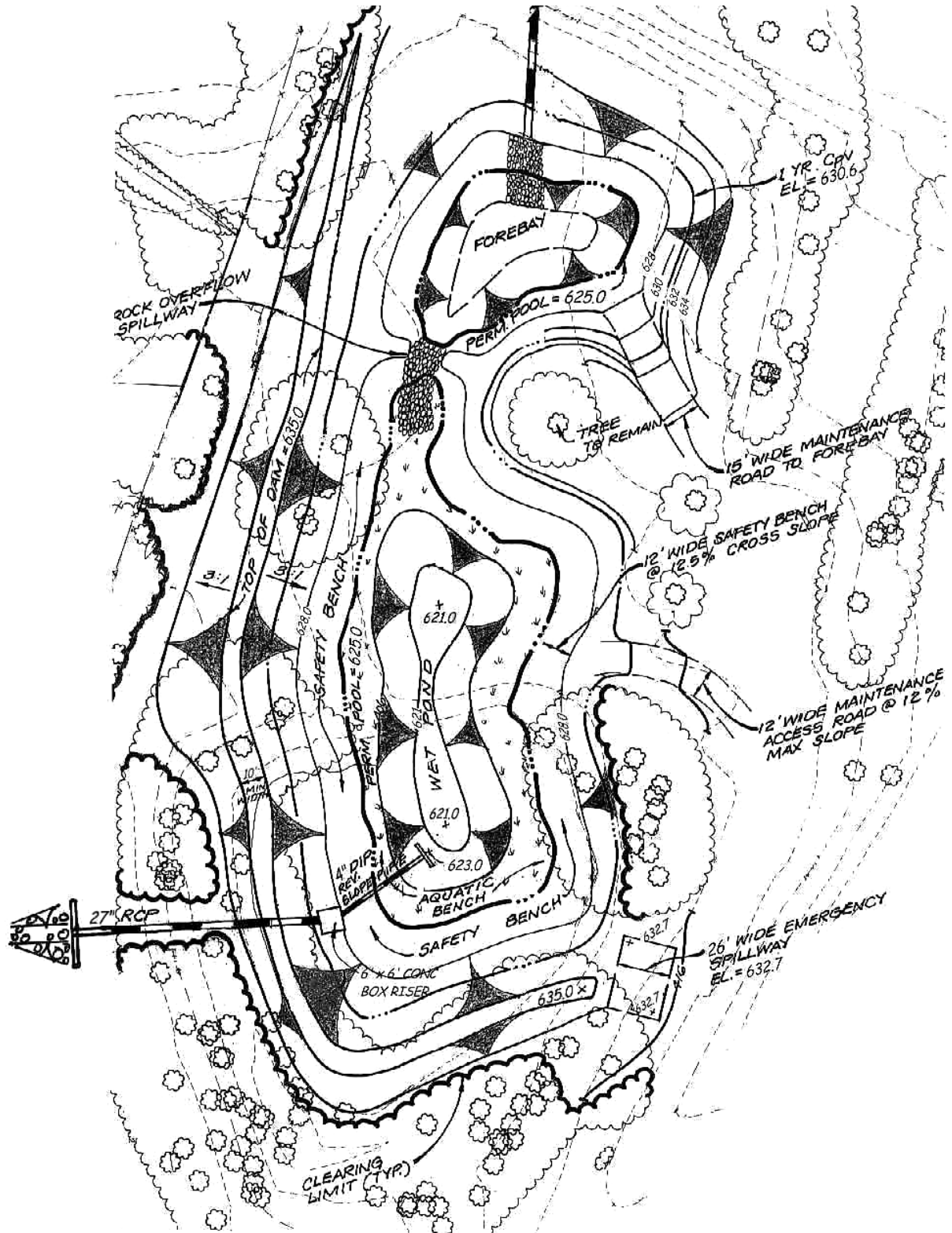
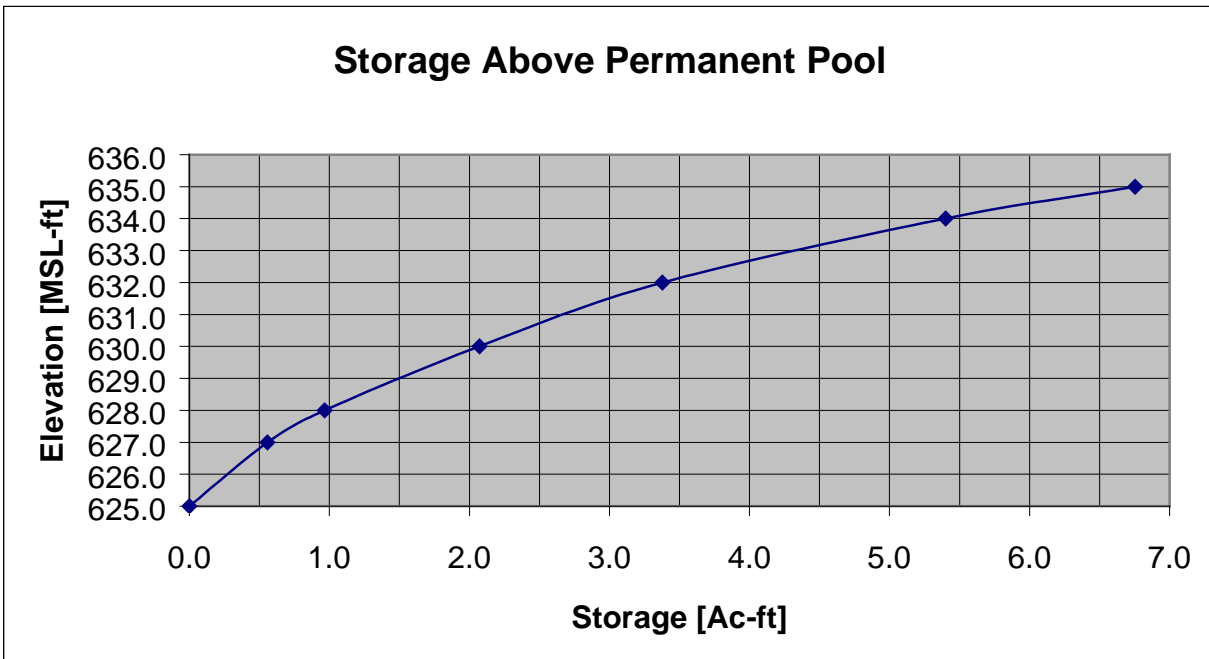

Figure 8.9 Storage-Elevation Table/Curve

Elevation MSL	Area ft ²	Average Area ft ²	Depth ft	Volume ft ³	Cumulative Volume ft ³	Cumulative Volume ac-ft	Volume Above Permanent Pool ac-ft
621.0	3150						
624.0	8325	5738	3	17213	17213	0.40	
625.0	10400	9363	1	9363	26575	0.61	0
627.0	13850	12125	2	24250	50825	1.17	0.56
628.0	21850	17850	1	17850	68675	1.58	0.97
630.0	26350	24100	2	48200	116875	2.68	2.07
632.0	30475	28413	2	56825	173700	3.99	3.38
634.0	57685	44080	2	88160	261860	6.01	5.40
635.0	60125	58905	1	58905	320765	7.36	6.75



Set basic elevations for pond structures

- The pond bottom is set at elevation 621.0
- Provide gravity flow to allow for pond drain, set riser invert at 620.5
- Set barrel outlet elevation at 620.0

Set water surface and other elevations

- Required permanent pool volume = 50% of $WQ_v = 0.54$ ac-ft. From the elevation-storage table, read elevation 625.0 (0.61 ac-ft > 0.54 ac-ft) site can accommodate it and it allows a small safety factor for fine sediment accumulation – OK

Set permanent pool wsel = 625.0

- Forebay volume provided in single pool with volume = 0.1 ac-ft - OK
- Required extended detention volume (WQ_{v-ED}) = 0.54 ac-ft. From the elevation-storage table (volume above permanent pool), read elevation 627.0 (0.56 ac-ft > 0.54 ac-ft) OK. Set ED wsel = 627.0

Note:

Total storage at elevation 627.0 = 1.17 ac-ft (greater than required WQ_v of 1.07 ac-ft)

Compute the required WQ_{v-ED} orifice diameter to release 0.54 ac-ft over 24 hours

- Avg. ED release rate = $(0.54 \text{ ac-ft})(43,560 \text{ ft}^2/\text{ac}) / (24 \text{ hr})(3600 \text{ sec/hr}) = 0.27 \text{ cfs}$
- Invert of orifice set at wsel = 625.0
- Average head = $(627.0 - 625.0) / 2 = 1.0'$
- Use orifice equation to compute cross-sectional area and diameter

$Q = CA(2gh)^{0.5}$, for $Q=0.27$ cfs $h = 1.0$ ft; $C = 0.6 =$ discharge coefficient. Solve for A

$A = 0.27 \text{ cfs} / [(0.6)((2)(32.2 \text{ ft/s}^2)(1.0 \text{ ft})^{0.5})]$ $A = 0.057 \text{ ft}^2$, $A = \pi d^2 / 4$;

dia. = 0.26 ft = 3.2", say 3.0 inches

Use 4" pipe with 4" gate valve to achieve equivalent diameter

Compute the stage-discharge equation for the 3.0" dia. WQ_v orifice

- $Q_{WQ_{v-ED}} = CA(2gh)^{0.5} = (0.6) (0.052 \text{ ft}^2) [((2)(32.2 \text{ ft/s}^2))^{0.5}] (h^{0.5})$,
- $Q_{WQ_{v-ED}} = (0.25) h^{0.5}$, where: $h = \text{wsel} - 625.125$

Note:

Account for one half of orifice diameter when calculating head)

Step 7. Compute ED orifice size, and compute release rate for C_pv-ED control and establish C_pv elevation.

Set the C_pv pool elevation

- Required C_pv storage = 2.4 ac-ft (see Table 1).
- From the elevation-storage table, read elevation 630.6 (this includes the WQ_v).
- Set C_pv wsel = 630.6

Size C_pv orifice

- Size to release average of 1.2 cfs.
- Set invert of orifice at wsel = 627.0
- Average WQ_v-ED orifice release rate is 0.41 cfs, based on average head of 2.74' ((630.6 – 625.125)/2)
- C_pv-ED orifice release = 1.2 - 0.41 = 0.79 cfs
- Head = (630.6 - 627.0)/2 = 1.8'

Use orifice equation to compute cross-sectional area and diameter

- $Q = CA(2gh)^{0.5}$, for h = 1.8'
- $A = 0.79 \text{ cfs} / [(0.6)((2)(32.2'/s^2)(1.8'))^{0.5}]$
- $A = 0.12 \text{ ft}^2$, $A = \pi d^2 / 4$;
- dia. = 0.39 ft = 4.7"
- Use 6" pipe with 6" gate valve to achieve equivalent diameter

Compute the stage-discharge equation for the 4.7" dia. C_pv orifice

- $Q_{C_{p_v}\text{-ED}} = CA(2gh)^{0.5} = (0.6) (0.12 \text{ ft}^2) [((2) (32.2'/s^2))^{0.5}] (h^{0.5})$,
- $Q_{C_{p_v}\text{-ED}} = (0.58) (h^{0.5})$, where: h = wsel – 627.2

NOTE:

ACCOUNT FOR ONE HALF OF ORIFICE DIAMETER WHEN CALCULATING HEAD

Step 8. Calculate Q_{p10} (10 year storm) release rate and water surface elevation.

In order to calculate the 10 year release rate and water surface elevation, the designer must set up a stage-storage-discharge relationship for the control structure for each of the low flow release pipes (WQ_v -ED and Cp_v -ED) plus the 10 year storm.

Develop basic data and information

- The 10 year pre-developed peak discharge = 72 cfs,
- The post developed inflow = 112 cfs, from Table 1,
- From previous estimate $Q_{p-10} = 2.26$ ac-ft. Adding 15% to account for ED storage yields a preliminary volume of 2.56 ac-ft.
- From elevation-storage table (Figure 8.9), read elevation 631.0.
- Size 10 year slot to release 72 cfs at elevation 631.0.

@ wsel 631.0:

- WQ_v -ED orifice releases 0.61 cfs,
- Cp_v -ED orifice releases 1.13 cfs, therefore;
- Allowable $Q_{p-10} = 72$ cfs - (.61 + 1.13) = 70.26 cfs, say 70.3 cfs.
- Set weir crest elevation at wsel = 630.6
- Max head = (631.0 – 630.6) = 0.4'

Use weir equation to compute slot length

- $Q = CLh^{3/2}$
- $L = 70.3$ cfs / (3.1) $(0.4^{3/2}) = 89.6$ ft
- This weir length is impractical, so adjust max head (and therefore slot height) to 1.5' and recalculate weir length.
- $L = 70.3$ cfs / (3.1) $(1.5^{3/2}) = 12.3$ ft

- Use three 5ft x 1.5 ft slots for 10-year release (opening should be slightly larger than needed so as to have the barrel control before slot goes from weir flow to orifice flow).
- Maximum $Q = (3.1)(15)(1.5)^{3/2} = 85.4$ cfs

Check orifice equation using cross-sectional area of opening

- $Q = CA(2gh)^{0.5}$, for $h = 0.75'$ (For orifice equation, h is from midpoint of slot)
- $A = 3 (5.0') (1.5') = 22.5\text{ft}^2$
- $Q = 0.6 (22.5\text{ft}^2) [(64.4)(0.75)]^{0.5} = 93.8$ cfs > 85.4 cfs, so use weir equation

$$Q_{10} = (3.1) (15') h^{3/2}, Q_{10} = (46.5) h^{3/2}, \text{ where } h = \text{wsel} - 630.6$$

- Size barrel to release approximately 70.3 cfs at elevation 632.1 (630.6 + 1.5)
- Check inlet condition: (use FHWA culvert charts)

$$H_w = 632.1 - 620.5 = 11.6 \text{ ft}$$

- Try 27" diameter RCP, Using FHWA Chart ("Headwater Depth for Concrete Pipe Culverts with Inlet Control") with entrance condition 1
- $H_w / D = 11.6/2.25 = 5.15$, Discharge = 69 cfs
- Check outlet condition (use NRCS pipe flow equation from NEH Section 5 ES-42):
- $Q = a [(2gh)/(1+k_m+k_pL)]^{0.5}$

where: Q = discharge in cfs

a = pipe cross sectional area in ft^2

g = acceleration of gravity in ft/sec^2

h = head differential (wsel - downstream centerline of pipe or tailwater elev.)

k_m = coefficient of minor losses (use 1.0)

k_p = pipe friction loss coef. ($= 5087n^2/d^{4/3}$, d in inches, n is Manning's n)

L = pipe length in ft

$$h = 632.1 - (620.0 + 1.125) = 10.98'$$

for 27" RCP, approximately 70 feet long:

$$Q = 4.0 [(64.4) (10.98) / (1+1+(0.0106) (70))]^{0.5} = 64.2 \text{ cfs}$$

64.2 cfs < 69 cfs, so barrel is outlet controlled and use outlet equation

$$Q = 19.4 (h)^{0.5}, \text{ where } h = \text{wsel} - 621.125$$

NOTE:

PIPE WILL CONTROL FLOW BEFORE HIGH STAGE INLET REACHES MAX HEAD.

Complete stage-storage-discharge summary (Figure 8.10) up to preliminary 10-year wsel (632.1) and route 10 year post-developed condition inflow using computer software (e.g., TR-20). Pond routing computes 10-year wsel at 632.5 with discharge = 65.4 cfs < 72 cfs, OK (see Figure 8.10).

NOTE:

ADEQUATE OUTFALL PROTECTION MUST BE PROVIDED IN THE FORM OF A RIPRAP CHANNEL, PLUNGE POOL, OR COMBINATION TO ENSURE NON-EROSIVE VELOCITIES.

Figure 8.10 Stage-Storage-Discharge Summary

Elevation MSL	Storage ac-ft	Low Flow WQv-ED 3.0" eq dia		Riser						27" Barrel				Emergency Spillway 26' earthen 3:1		Total Discharge	
				Cpv-ED 4.7" eq. dia		High Stage Slot				Inlet		Pipe					
						Orifice		Weir									
		H ft	Q cfs	H ft	Q cfs	H ft	Q cfs	H ft	Q cfs	H ft	Q cfs	H ft	Q cfs	H ft	Q cfs	Q cfs	
625.0	0.00	0	0														0.00
625.5	0.14	0.4	0.15														0.15
626.0	0.28	0.9	0.23														0.23
626.5	0.42	1.4	0.29														0.29
627.0	0.56	1.9	0.34	0.0	0.00												0.34
627.5	0.77	2.4	0.39	0.3	0.32												0.70
628.0	0.97	2.9	0.42	0.8	0.52												0.94
629.0	1.52	3.9	0.49	1.8	0.78												1.27
629.5	1.80	4.4	0.52	2.3	0.88												1.40
630.0	2.07	4.9	0.55	2.8	0.97												1.52
630.6	2.40	5.5	0.58	3.4	1.07	-	-	0.0	0.0								1.65
631.0	2.73	5.9	0.61	3.8	1.13	-	-	0.4	11.8								13.5
632.1	3.45	7.0	0.66	4.9	1.28	0.75	94	1.5	85.4	11.6	69.0	11.0	64.2				64.2
632.5	3.80	7.4	0.68	5.3	1.34	0.95	106	-	-	12.0	70.0	11.4	65.4				65.4
632.7	4.10	7.6	0.69	5.5	1.36	1.05	111	-	-	12.2	71.0	11.6	66.0	0.0	0.0		66.0
633.3	4.70	-	-	-	-	-	-	-	-	12.8	72.0	12.2	67.6	0.6	26.0		93.6
634.0	5.40	-	-	-	-	-	-	-	-	13.5	73.0	12.9	69.6	1.3	95.0		164.6
635.0	6.75	-	-	-	-	-	-	-	-	14.5	86.0	13.9	72.2	2.3	251.0		323.2

Step 9. Calculate spillway design flood release rate and water surface elevation (wsel), size emergency spillway, calculate spillway design flood wsel.

For a Hazard Class “A” dam, in order to calculate the 100-year release rate and water surface elevation, the designer must continue with the stage-storage-discharge relationship (Figure 8.10) for the control riser and emergency spillway.

Develop basic data and information

- The 100 year pre-developed peak discharge = 141 cfs,
- The post developed inflow = 202 cfs, from Table 1,
- From previous estimate $Q_{p-100} = 3.53$ ac-ft. Adding 15% to account for ED storage yields a preliminary volume of 4.06 ac-ft.
- From elevation-storage table (Figure 8.10), read elevation 632.8, say 633.0.

The 10-year wsel is at 632.5. Set the emergency spillway at elevation at 632.7 (this allows for some additional storage above the 10-yr wsel) and use design information and criteria for Earth Spillways (not included in this manual).

- Size 100 year spillway to release 141 cfs at elevation 633.0.
- @ wsel 633.0:
- Outflow from riser structure is controlled by barrel (under outlet control), from Figure 8.10, read $Q = 67.6$ cfs at wsel = 633.3. Assume $Q = 67$ cfs at wsel = 633.0.
- Set spillway invert at wsel = 632.7
- Try 26' wide vegetated emergency spillway with 3:1 side slopes.
- Finalize stage-storage-discharge relationships and perform pond routing

Pond routing (TR-20) computes 100-year wsel at 633.76 with discharge = 140.95 cfs < 141 cfs, OK (see Figure 8.11).

NOTE:

THIS PROCESS OF SIZING THE EMERGENCY SPILLWAY AND STORAGE VOLUME DETERMINATION IS USUALLY ITERATIVE. THIS EXAMPLE REFLECTS PREVIOUS ITERATIONS AT ARRIVING AT AN ACCEPTABLE DESIGN SOLUTION.

Step 10. Check for safe passage of Q_{p100} under current build-out conditions and set top of embankment elevation.

The safety design of the pond embankment requires that the 100-year discharge, based on ultimate buildout conditions be able to pass safely through the emergency spillway with sufficient freeboard (one foot). This criteria does not mean that the ultimate buildout peak discharge be attenuated to pre-development rates.

From previous hydrologic modeling we know that:

- The 100 year ultimate buildout peak discharge = 227 cfs,
- The ultimate buildout composite curve number is 82.

Using TR-20 or equivalent routing model, determine peak wsel. Pond routing computes 100-year wsel at 634.0 with discharge = 192 cfs (Figure 8.12).

Therefore, with one foot of freeboard, the minimum embankment elevation is 635.0. Table 8.2 provides a summary of the storage, stage, and discharge relationships determined for this design example. See Figure 8.13 for a schematic of the riser.

Table 8.2 Summary of Controls Provided

Control Element	Type/Size of Control	Storage Provided	Elevation	Discharge	Remarks
Units		Acre-feet	MSL	cfs	
Permanent Pool		0.61	625.0	0	part of WQ_v
Forebay	submerged berm	0.1	625.0	0	included in permanent pool vol.
Extended Detention (WQ_v -ED)	4" pipe, sized to 3.0" equivalent diameter	0.56	627.0	0.25	part of WQ_v , vol. above perm. pool, discharge is average release rate over 24 hours
Channel Protection (Cp_v -ED)	6" pipe sized to 4.7" equivalent diameter	2.4	630.6	1.2	volume above perm. pool, discharge is average release rate over 24 hours
Overbank Protection (Q_{p-10})	Three 5' x 1.5' slots on a 6' x 6' riser, 27" barrel.	2.5	632.5	65.4	volume above perm. pool
Extreme Storm (Q_{f-100})	26' wide earth spillway	4.0	633.8	140.9	volume above perm. pool
Extreme Storm Ultimate Buildout	26' wide earth spillway	NA	634	192.0	Set minimum embankment height at 635.0

Figure 8.11 TR-20 Model Input and Output

*****80-80 LIST OF INPUT DATA FOR TR-20 HYDROLOGY*****

```

JOB TR-20          FULLPRINT          NOPLOTS
TITLE   New York Manual Wet ED Example 1/01   EWB
TITLE   Post Developed Conditions Routing for 1, 10, and 100
3 STRUCT      1
8           625.0    0.0    0.0
8           625.5    0.15   0.14
8           626.0    0.23   0.28
8           626.5    0.29   0.42
8           627.0    0.34   0.56
8           627.5    0.70   0.77
8           628.0    0.94   0.97
8           629.0    1.27   1.52
8           629.5    1.40   1.80
8           630.0    1.52   2.07
8           630.6    1.65   2.40
8           631.0   13.50   2.73
8           632.1   64.20   3.45
8           632.7   66.00   4.10
8           633.3   93.60   4.70
8           634.0  165.0    5.40
8           635.0  35230    6.75
9 ENDTBL
6 RUNOFF 1  1  2 0.102   78.0   0.35   1 1 0 0 1
6 RESVOR 2  1  2  3 625.0           1 1   1
  ENDDATA
7 INCREM 6      0.1
7 COMPUT 7  1  1 0.0    2.3    1.0    2 2 1 0 1
  ENDCMP 1
7 COMPUT 7  1  1 0.0    3.9    1.0    2 2 1 10
  ENDCMP 1
7 COMPUT 7  1  1 0.0    5.5    1.0    2 2 1 99
  ENDCMP 1
ENDJOB 2
    
```

*****END OF 80-80 LIST*****

TR20 XEQ 1/22/**
REV 09/01/83

New York Manual Wet ED Example 1/01
Post Developed Conditions Routing for 1, 10, and 100

EWB

JOB 1 SUMMARY
PAGE 8

SUMMARY TABLE 1 - SELECTED RESULTS OF STANDARD AND EXECUTIVE CONTROL INSTRUCTIONS IN THE ORDER PERFORMED
(A STAR(*) AFTER THE PEAK DISCHARGE TIME AND RATE (CFS) VALUES INDICATES A FLAT TOP HYDROGRAPH
A QUESTION MARK(?) INDICATES A HYDROGRAPH WITH PEAK AS LAST POINT.)

SECTION/ STRUCTURE ID	STANDARD CONTROL OPERATION	DRAINAGE AREA (SQ MI)	RAIN TABLE #	ANTEC MOIST COND	MAIN TIME INCREM (HR)	PRECIPITATION			RUNOFF AMOUNT (IN)	PEAK DISCHARGE			
						BEGIN (HR)	AMOUNT (IN)	DURATION (HR)		ELEVATION (FT)	TIME (HR)	RATE (CFS)	RATE (CSM)
ALTERNATE 1 STORM		1											
STRUCTURE 1	RUNOFF	.10	2	2	.10	.0	2.30	24.00	.66	---	12.13	40.62	398.2
STRUCTURE 1	RESVOR	.10	2	2	.10	.0	2.30	24.00	.40	630.31	18.00?	1.59?	15.6
ALTERNATE 1 STORM		10											
STRUCTURE 1	RUNOFF	.10	2	2	.10	.0	3.90	24.00	1.81	---	12.11	118.47	161.5
STRUCTURE 1	RESVOR	.10	2	2	.10	.0	3.90	24.00	1.49	632.51	12.34	65.43	41.5
ALTERNATE 1 STORM		99											
STRUCTURE 1	RUNOFF	.10	2	2	.10	.0	5.50	24.00	3.14	---	12.11	206.59	025.4
STRUCTURE 1	RESVOR	.10	2	2	.10	.0	5.50	24.00	2.80	633.76	12.29	140.95	381.9

Figure 8.12 TR-20 Model Input and Output for Ultimate Buildout Conditions

TR20 XEQ 1/22/** New York Manual Wet ED Example 1/01 EWB JOB 1 SUMMARY
 REV 09/01/83 Ultimate Buildout Conditions for 100-yr PAGE 4

SUMMARY TABLE 1 - SELECTED RESULTS OF STANDARD AND EXECUTIVE CONTROL INSTRUCTIONS IN THE ORDER PERFORMED
 (A STAR(*) AFTER THE PEAK DISCHARGE TIME AND RATE (CFS) VALUES INDICATES A FLAT TOP HYDROGRAPH
 A QUESTION MARK(?) INDICATES A HYDROGRAPH WITH PEAK AS LAST POINT.)

SECTION/ STRUCTURE ID	STANDARD CONTROL OPERATION	DRAINAGE AREA (SQ MI)	RAIN TABLE #	ANTEC MOIST COND	MAIN TIME INCREM (HR)	PRECIPITATION			RUNOFF AMOUNT (IN)	PEAK DISCHARGE				
						BEGIN (HR)	AMOUNT (IN)	DURATION (HR)		ELEVATION (FT)	TIME (HR)	RATE (CFS)	RATE (CSM)	
ALTERNATE	1	STORM	99											
STRUCTURE	1	RUNOFF	.10	2	2	.10	.0	5.50	24.00	3.53	---	12.10	230.71	2261.9
STRUCTURE	1	RESVOR	.10	2	2	.10	.0	5.50	24.00	3.19	634.00	12.22	191.83	1880.7

Figure 8.13 Profile of Principle Spillway

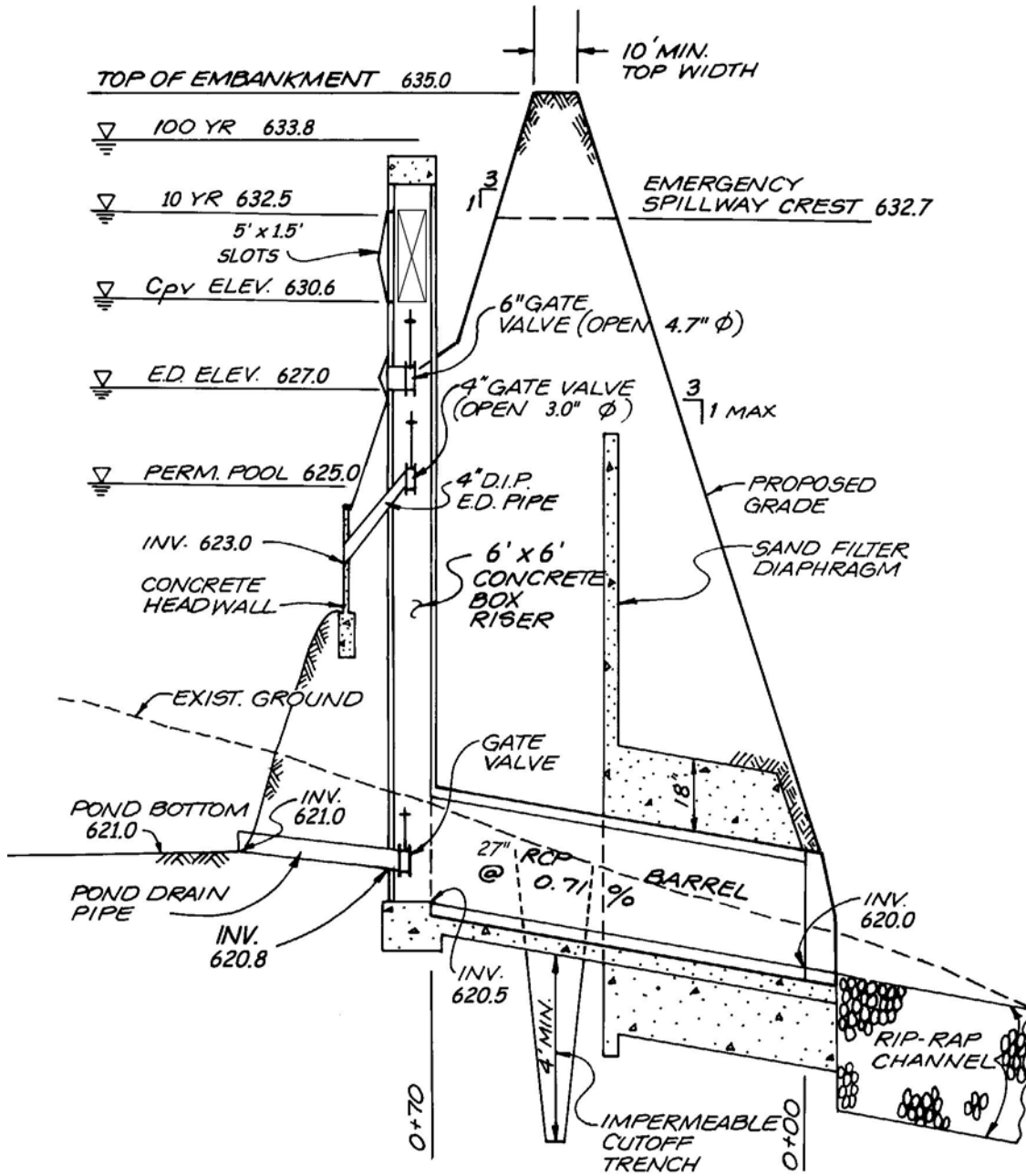

Section 8.3 Sand Filter Design Example

This design example focuses on the design of a sand filter for a 4.5-acre catchment of Lake Center, a hypothetical commercial site located in Albany, NY. A five-story office building and associated parking are proposed within the catchment. The layout is shown in Figure 8.14. The catchment has 3.05 acres of impervious cover, resulting in 68% impervious cover. The pre-developed site is a mixture of forest and meadow. On-site soils are predominantly HSG “B” soils.

Figure 8.14 Lake Center Site Plan

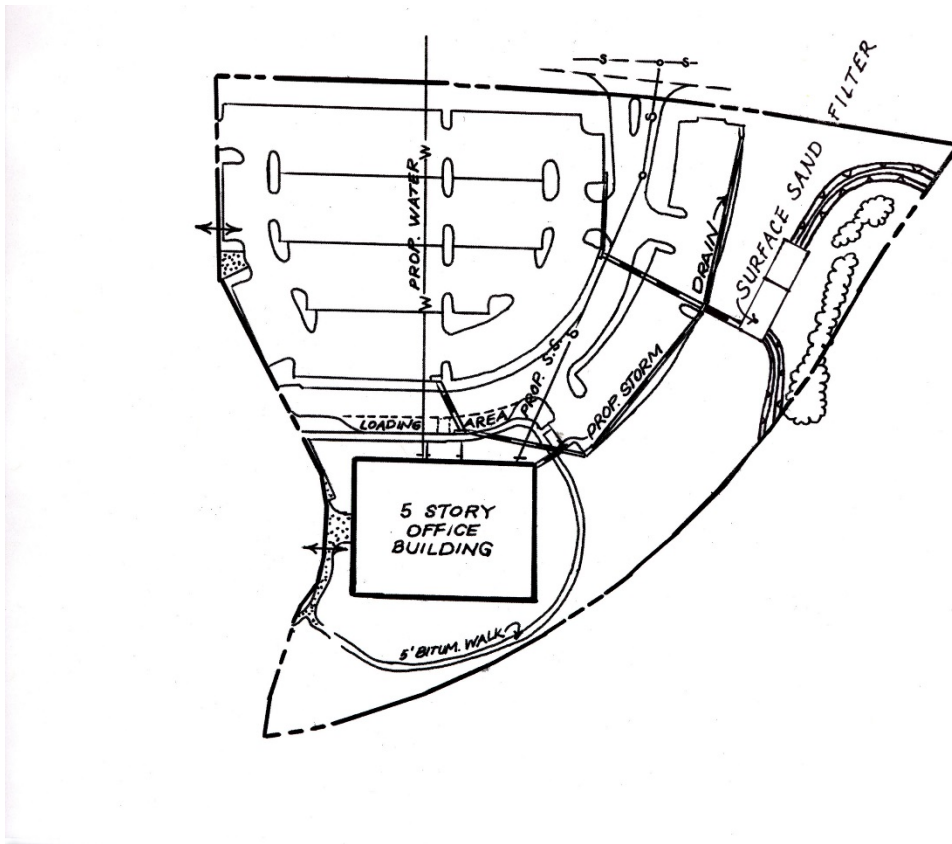

Hydrologic Data		
	<u>Pre</u>	<u>Post</u>
CN	58	83
t _c (hr)	0.44	0.10

Base Data

Location: Albany, NY

Site Area = Total Drainage Area (A) = 4.50 ac

Impervious Area = 3.05 ac; or I = 3.05/4.50 = 68%

Soils Type "B"

This step-by-step example will focus on meeting the water quality requirements. Channel protection control, overbank flood control, and extreme flood control are not addressed in this example. Therefore, a detailed hydrologic analysis is not presented. For an example of detailed sizing calculations, consult section 8.1. In general, the primary function of sand filters is to provide water quality treatment and not large storm attenuation. As such, flows in excess of the water quality volume are typically routed to bypass the facility. For this example, the post-development 10-yr peak discharge is provided to appropriately size the necessary by-pass flow splitter. Where quantity control is required, bypassed flows can be routed to conventional detention basins (or some other facility such as underground storage vaults).

Step 1. Compute design volumes using the Unified Stormwater Sizing Criteria.

Water Quality Volume, WQ_v

Select the Design Storm

Consulting Figure 4.1 of this document, use 1.0" as the 90% rainfall event for Albany.

Compute Runoff Coefficient, R_v

$$R_v = 0.05 + (68)(0.009) = 0.66$$

Compute WQ_v

$$\begin{aligned} \text{WQ}_v &= (1.0'') (R_v) (A) / 12 \\ &= (1.0'') (0.66) (4.5 \text{ ac}) (43,560 \text{ ft}^2/\text{ac}) (1 \text{ ft}/12 \text{ in}) \\ &= 10,781 \text{ ft}^3 = 0.25 \text{ ac-ft} \end{aligned}$$

Develop Site Hydrologic Input Parameters and Perform Preliminary Hydrologic Calculations (see Table 8.3)

NOTE:

FOR THIS DESIGN EXAMPLE, THE 10-YEAR PEAK DISCHARGE IS GIVEN AND WILL BE USED TO SIZE THE BYPASS FLOW SPLITTER. ANY HYDROLOGIC MODELS USING SCS PROCEDURES, SUCH AS TR-20, HEC-HMS, OR HEC-1, CAN BE USED TO PERFORM PRELIMINARY HYDROLOGIC CALCULATIONS.

Condition	CN	Q ₁	Q ₂	Q ₁₀	Q ₁₀₀
		cfs	cfs	cfs	cfs
Pre-developed	58	0.2	0.4	3	9
Post-Developed	83	7	10	19	36

Step 2. Determine if the development site and conditions are appropriate for the use of a surface sand filter.

Site Specific Data:

Existing ground elevation at practice location is 222.0 feet, mean sea level. Soil boring observations reveal that the seasonally high water table is at 211.0 feet. Adjacent drainage channel invert is at 213.0 feet.

Step 3. Compute available head, & peak discharge (Q_{wq}).

- Determine available head (See Figure 8.15)

The low point at the parking lot is 223.5. Subtract 2' to pass the Q₁₀ discharge (221.5) and a half foot for the inflow channel to the facility (221.0). The low point at the channel invert is 213.0. Set the outfall underdrain pipe 1.0' above the drainage channel invert and add 0.5' to this value for the drain slope (214.5). Add to this value 8" for the gravel blanket over the underdrains, and 18" for the sand bed (216.67). The total available head is 221.0 - 216.67 or 4.33 feet. Therefore, the available average depth (h_f) = $4.33' / 2 = 2.17'$.

Figure 8.15 Available Head Diagram

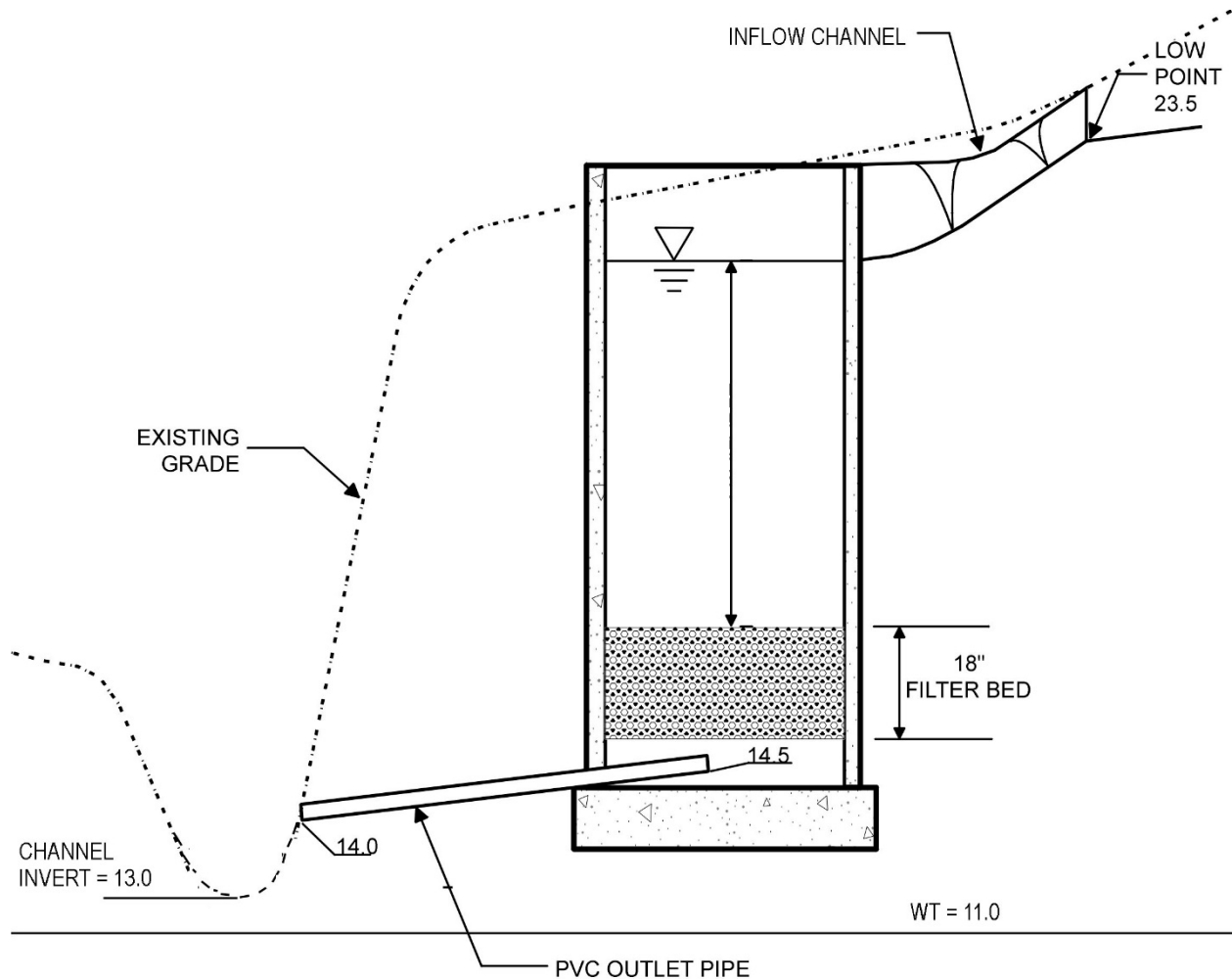

- Compute Peak Water Quality Discharge:

The peak rate of discharge for the water quality design storm is needed for the sizing of off-line diversion structures, such as sand filters and grass channels. The Small Storm Hydrology Method presented in Appendix B was followed to calculate a modified curve number and subsequent peak discharge associated with the 1.0-inch rainfall. Calculation steps are provided below.

Compute modified CN for 1.0" rainfall

P = 1.0"

$$Q_a = WQ_v \div \text{area} = (10,781 \text{ ft}^3 \div 4.5 \text{ ac} \div 43,560 \text{ ft}^2/\text{ac} \times 12 \text{ in}/\text{ft}) = 0.66"$$

$$\begin{aligned} \text{CN} &= 1000/[10+5P+10Q_a-10(Q_a^2+1.25*Q_a*P)^{1/2}] \\ &= 1000/[10+5*1.0+10*0.66-10(0.66^2+1.25*0.66*1.0)^{1/2}] \\ &= 96.4 \end{aligned}$$

Use CN = 96

For CN = 96 and the $t_c = 0.1$ hours, compute the Q_{wq} for a 1.0" storm. With the CN = 96, a 1.0" storm will produce 0.6" of runoff. From TR-55 Chapter 2, Hydrology, $I_a = 0.083$, therefore:

$$I_a/P = 0.083/1.0 = 0.083.$$

From TR-55 Chapter 4 $q_u = 1000$ csm/in, and

$$Q_{wq} = (1000 \text{ csm/in}) (4.5 \text{ ac}/640\text{ac/sq mi.}) (0.66") = \underline{4.6 \text{ cfs.}}$$

Step 4. Size the flow diversion structure.

Assume that flows are diverted to a diversion structure (Figure 8.16). First, size a low-flow orifice to pass the water quality storm ($Q_p = 4.6$ cfs).

$$Q = CA(2gh)^{1/2}; 4.6 \text{ cfs} = (0.6) (A) [(2) (32.2 \text{ ft/s}^2) (1.5')]^{1/2}$$

$$A = 0.77 \text{ sq ft} = \pi d^2/4; d = 0.99' \text{ or } \underline{12"}$$

Size the 10-year overflow as follows:

The 10-year wsel is initially set at 223.0. Use a concrete weir to pass the 10-year flow (19.0 cfs), minus the flow carried by the low flow orifice, into a grassed overflow channel using the Weir equation. Assume 2' of head to pass this event. Overflow channel should be designed to provide sufficient energy dissipation (e.g., riprap, plunge pool, etc.) so that there will be non-erosive velocities.

Determine the flow from the low-flow orifice (Q_{lf}). Assume 3.5' of head (1.5' plus 2' for the 10-year head):

$$Q_{lf} = (0.6) (A) [(2) (32.2 \text{ ft/s}^2) (3.5')]^{1/2}$$

$$\begin{aligned} A &= \pi (1')^2/4 \\ &= 0.78 \text{ sf} \end{aligned}$$

So,

$$\begin{aligned} Q_{lf} &= (0.6) (0.78) [(2) (32.2 \text{ ft/s}^2) (3.5')]^{1/2} \\ &= 7.0 \text{ cfs} \end{aligned}$$

Thus, determine the flow passed to the through the channel as:

$$Q = CLH^{3/2}$$

$$(19-7) = 3.1 (L) (2')^{1.5}$$

$L = 1.4'$ which sets the minimum length of the flow diversion overflow weir.

Weir wall elev. = 21.0. Set low flow invert at $21.0 - [1.5' + (0.5 \times 12'' \times 1\text{ft}/12'')] = 19.00$.

Figure 8.16 Flow Diversion Structure

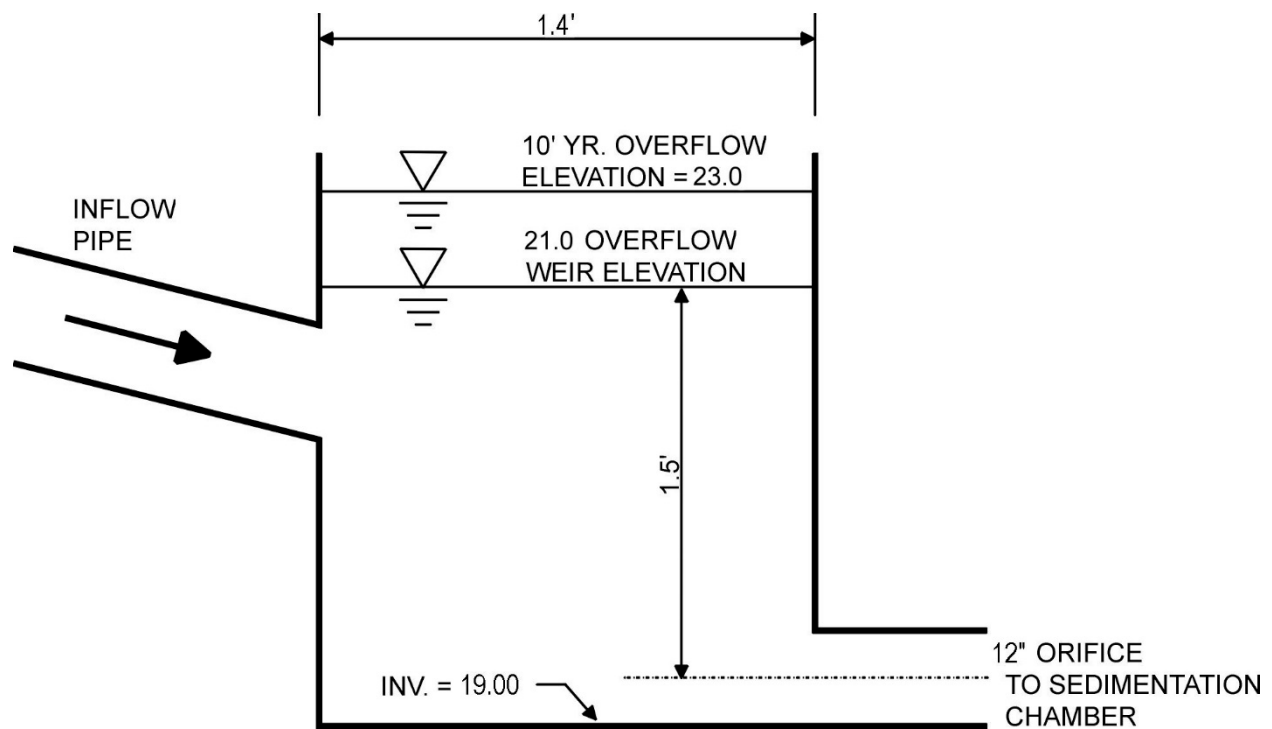

Step 5. Size filtration bed chamber (see Figure 8.17).

From Darcy's Law: $A_f = WQ_v (d_f) / [k (h_f + d_f) (t_f)]$

where $d_f = 18''$ or $1.5'$ (Filter thickness)

$k = 3.5$ ft/day (Flow-through rate)

$h_f = 2.17'$ (Average head on filter)

$$t_f = 40 \text{ hours} \quad (\text{Drain time})$$

$$A_f = (10,781 \text{ cubic feet}) (1.5') / [3.5 (2.17' + 1.5') (40\text{hr}/24\text{hr}/\text{day})]$$

$$A_f = \underline{755 \text{ sq ft}}; \text{ filter is } \underline{20' \text{ by } 40'} (= 800 \text{ sq ft})$$

Step 6. Size sedimentation chamber.

Size the sedimentation chamber as wet storage with a 2.5' depth. Determine the pretreatment volume as:

$$P_v = (0.25) (10,781 \text{ cf})$$

$$= 2,695 \text{ cf}$$

Therefore,

$$A_s = (2,695 \text{ cf}) / (2.5')$$

$$= 1,078 \text{ sf} \quad (\text{Use } 20' \times 55' \text{ or } 1,100 \text{ sf})$$

Step 7. Compute V_{\min} .

$$V_{\min} = \frac{3}{4}(WQ_v) \text{ or } 0.75 (10,781 \text{ cubic feet}) = \underline{8,086 \text{ cubic feet}}$$

Step 8. Compute volume within practice.

Volume within filter bed (V_f): $V_f = A_f (d_f) (n)$; $n = 0.4$ for sand

$$V_f = (800 \text{ sq ft}) (1.5') (0.4) = \underline{480 \text{ cf}}$$

temporary storage above filter bed ($V_{f\text{-temp}}$): $V_{f\text{-temp}} = 2h_f A_f$

$$V_{f\text{-temp}} = 2 (2.17') (800 \text{ sq ft}) = \underline{3,472 \text{ cf}}$$

Compute storage in the sedimentation chamber (V_s):

$$V_s = (2.5')(1,100 \text{ sf}) + 4.33'(1,100 \text{ sf}) = 7,513 \text{ cf}$$

$$V_f + V_{f\text{-temp}} + V_s = 480 \text{ cf} + 3,472 \text{ cf} + 7,513 \text{ cf} = 11,465 \text{ cf}$$

11,465 > 8,086 OK.

Pass flow through to the distribution chamber using a 12" orifice with an inverted elbow (see Figure 8.17).

Step 9. Compute sedimentation chamber and filter bed overflow weir sizes.

Assume overflow that needs to be handled is equivalent to the 12" orifice discharge under a head of 3.5 ft (i.e., the head in the diversion chamber associated with the 10-year peak discharge).

$$Q = CA(2gh)^{1/2}$$

$$Q = 0.6(0.79 \text{ ft}^2)[(2)(32.2 \text{ ft/s}^2)(3.5 \text{ ft})]^{1/2}$$

$$Q = 7.1 \text{ cfs}$$

Size the overflow weir from the sediment chamber and the filtration chamber to pass 7.1 cfs (this assumes no attenuation within the practice).

Weir equation: $Q = CLh^{3/2}$, assume a maximum allowable head of 0.5'

$$7.1 = 3.1 * L * (0.5 \text{ ft})^{3/2}$$

$$L = 6.5 \text{ ft.}$$

Adequate outlet protection and energy dissipation (e.g., riprap, plunge pool, etc.) should be provided for the downstream overflow channel.

Figure 8.17 Plan and Profile of Surface Sand Filter

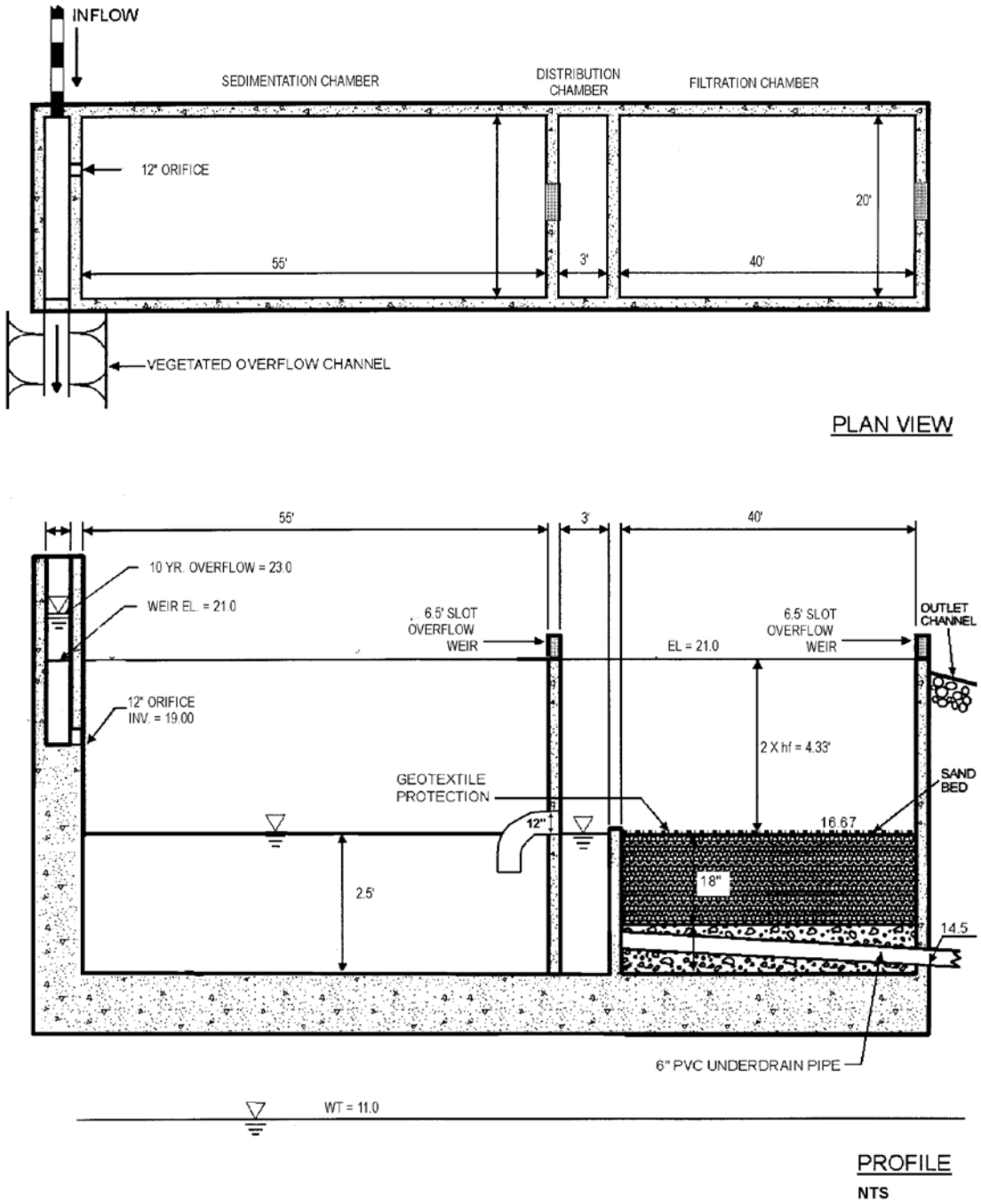

Section 8.4 Infiltration Trench Design Example

This design example focuses on the design of an infiltration trench for a 4.5-acre catchment of the Lake Center, a hypothetical commercial site located in Albany, NY. A five-story office building and associated parking are proposed within this catchment. The layout is shown in Figure 8.18. The catchment has 3.05 acres of impervious cover, resulting in a site impervious cover of 68%. The pre-developed site is a mixture of forest and meadow. On-site soils are predominantly HSG "B" soils.

Figure 8.18 Lake Center Site Plan

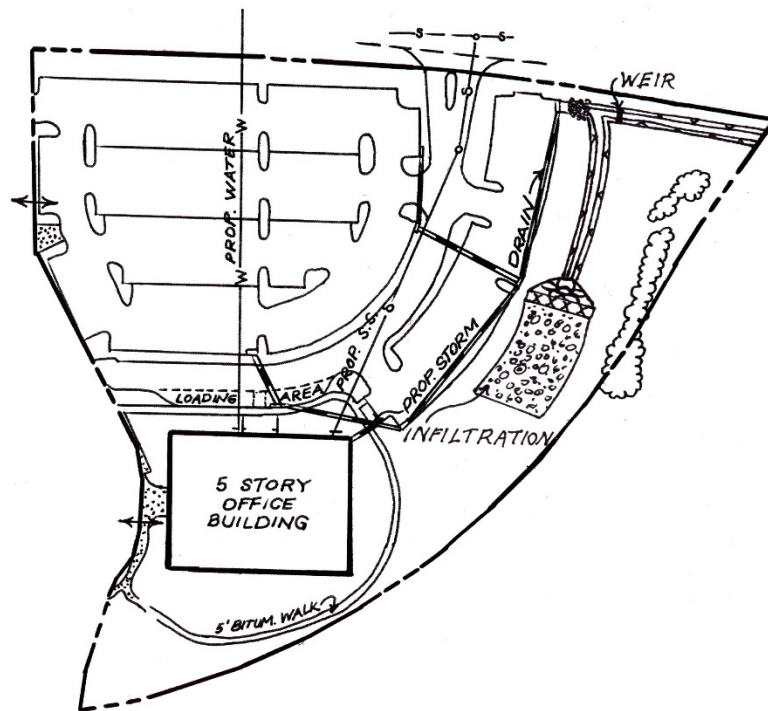

Hydrologic Data		
	<u>Pre</u>	<u>Post</u>
CN	58	83
t _c (hr)	0.44	0.10

Base Data

Location: Albany, NY
 Site Area = Total Drainage Area (A) = 4.5 ac
 Impervious Area = 3.05 ac; or I = 3.05/4.50 = 68%
 Soils Type “B”

This step-by-step example will focus on meeting the water quality requirements. Channel protection control, overbank flood control, and extreme flood control are not addressed in this example. Therefore, a detailed hydrologic analysis is not presented. For an example of detailed sizing calculations, consult section 8.1. In general, the primary function of infiltration practices is to provide water quality treatment and not large storm attenuation. As such, flows in excess of the water quality volume are typically routed to bypass the facility. For this example, the post-development 10-yr peak discharge is provided to appropriately size the necessary by-pass flow splitter. Where quantity control is required, bypassed flows can be routed to conventional detention basins (or some other facility such as underground storage vaults).

Step 1. Compute design volumes and flows using the Unified Stormwater Sizing Criteria.

Design values are presented in Table 8.4 below.

Table 8.4 Site Design Hydrology					
Condition	CN	WQ _v	Q ₁	Q ₂	Q ₁₀
		ft ³	cfs	cfs	cfs
Pre-Developed	58		0.2	0.4	3
Post-Developed	83	10,781	7	10	19

Step 2. Determine if the development site and conditions are appropriate for the use of an infiltration trench.

Site Specific Data:

Table 8.5 presents site-specific data, such as soil type, percolation rate, and slope, for consideration in the design of the infiltration trench. See Appendix D for infiltration testing requirements and Appendix C for infiltration practice construction specifications.

Table 8.5 Site Specific Data	
Criteria	Value
Soil	Silt Loam
Percolation Rate	0.5"/hour
Ground Elevation at BMP	219'
Seasonally High Water Table	211'
Local Ground Slope	<1%

Step 3. Confirm local design criteria and applicability.

Table 8.6, below, summarizes the requirements that need to be met to successfully implement infiltration practices. On this site, infiltration is feasible, with restrictions on the depth and width of the trench.

Table 8.6 Infiltration Feasibility	
Criteria	Status
Infiltration rate (f_c) greater than or equal to 0.5 inches/hour.	<ul style="list-style-type: none"> Infiltration rate is 0.5 inches/hour. OK.
Soils have a clay content of less than 20% and a silt/clay content of less than 40%.	<ul style="list-style-type: none"> Silt Loam meets both criteria.
Infiltration cannot be located on slopes greater than 6% or in fill soils.	<ul style="list-style-type: none"> Slope is <1%; not fill soils. OK.
Hotspot runoff should not be infiltrated.	<ul style="list-style-type: none"> Not a hotspot land use. OK.
The bottom of the infiltration facility must be separated by at least three feet vertically from the seasonally high water table.	<ul style="list-style-type: none"> Elevation of seasonally high water table: 11' Elevation of BMP location: 19'. The difference is 8'. Thus, the trench can be up to 5' deep. OK.
Infiltration facilities must be located 100 feet horizontally from any water supply well.	<ul style="list-style-type: none"> No water supply wells nearby. OK.
Maximum contributing area generally less than 5 acres.	<ul style="list-style-type: none"> Area draining to facility is approximately 4.5 acres.
Setback 25 feet down-gradient from structures.	<ul style="list-style-type: none"> Trench edge is > 25' from all structures. OK.

Step 4. Size overflow channel.

Water flows from the edge of the parking lot to a 4' wide, flat bottom channel with 3:1 side slopes and a 2% slope. This channel also provides pretreatment (See Step 6). Use a weir to divert the water quality volume to the infiltration trench, while allowing the 10-year event to an adjacent drainage channel and the water quality storm to flow to the infiltration trench. The peak flow for the water quality storm is 4.6 cfs (see Section 8.3 for an example calculation).

Determine the depth of flow for the water quality storm using Manning's equation. (Several software packages can be used). The following assumptions are made:

Trapezoidal channel with 3:1 side slopes

4' bottom width.

$S = 2\%$

n varies between 0.03 at 1' depth to 0.15 at 4" depth (See Appendix L and Grass Channel Fact Sheet in Chapter 5).

Determine that the water quality storm passes at $d = 0.6'$.

Size a weir to pass the 10-year peak event, less the water quality peak flow, so that:

$$Q = 19\text{cfs} - 4.6\text{ cfs} = 14.4\text{ cfs.}$$

Use a weir length, L, of 4.0'.

By rearranging the weir equation:

$$H = (Q/CL)^{2/3} = (14.4/3.1(4))^{2/3} = 1.1'$$

Size the channel to pass the 10-year event with 6" of freeboard.

Step 5. Size the infiltration trench.

The area of the trench can be determined by the following equation:

$$A = WQ_v / (nd)$$

Where:

- A = Surface Area
- WQ_v = Water Quality volume (ft³)
- n = Porosity
- d = Trench depth (feet)

Assume that:

- n = 0.4
- d = 5 feet

Therefore:

- A = 10,781 ft³ / (0.4 × 5)ft
- A = 5,391ft²

The proposed location for the infiltration trench will accommodate a trench width of up to 50 feet. Therefore, the minimum length required would be:

$$L = 5,391 \text{ ft}^2 / 50 \text{ ft}$$

$$L = 108 \text{ feet, say } 110 \text{ feet}$$

Step 6. Size pretreatment.

Pass the 10-year flow event through an overflow channel.

Size pretreatment to treat $\frac{1}{4}$ of the WQ_v . Therefore, treat $10,781 \times 0.25 = 2,695 \text{ ft}^3$.

For pretreatment, use a pea gravel filter layer with filter fabric, a plunge pool, and a grass channel.

Pea Gravel Filter

The pea gravel filter layer covers the entire trench with 2" (see Figure 8.19). Assuming a porosity of 0.32, the pretreatment volume (P_v) provided in the pea gravel filter layer is:

$$P_{v_{\text{filter}}} = (0.32)(2")(1 \text{ ft}/12 \text{ inches})(110')(50') = 293 \text{ ft}^3$$

Plunge Pools

Use a 50' X 20' triangular plunge pool with an average two foot depth as flow is diverted to the infiltration trench.

$$P_{v_{\text{pool}}} = (50 \times 20 \text{ ft})/2 * (2 \text{ ft}) = 1,000 \text{ ft}^3$$

Grass Channel

Accounting for the pretreatment volumes provided by the pea gravel filter and plunge pool, the grass channel then needs to treat at least $(2,695 - 293 - 1,000) \text{ ft}^3 = 1,402 \text{ ft}^3$

Currently stormwater flows through a 150' long channel, with parameters described under step 4. For this channel, the flow velocity of the peak flow from the water quality storm (4.6 cfs) is approximately 1.2 fps.

Using a required residence time of 10 minutes (600 seconds), the required length of channel for 100% of the WQ_v (10,781 ft^3) would be $1.3 \text{ fps} \times 600 \text{ sec} = 780 \text{ ft}$.

Adjust the length to account for the volume that must be provided, or:

$$(780\text{ft})(1,402\text{ ft}^3)/(10,781\text{ ft}^3) = 101\text{ ft}$$

Therefore, for this example, a grass channel of at least 101 feet is required. 150' is OK.

Figure 8.19 Schematic Infiltration Trench Cross Section

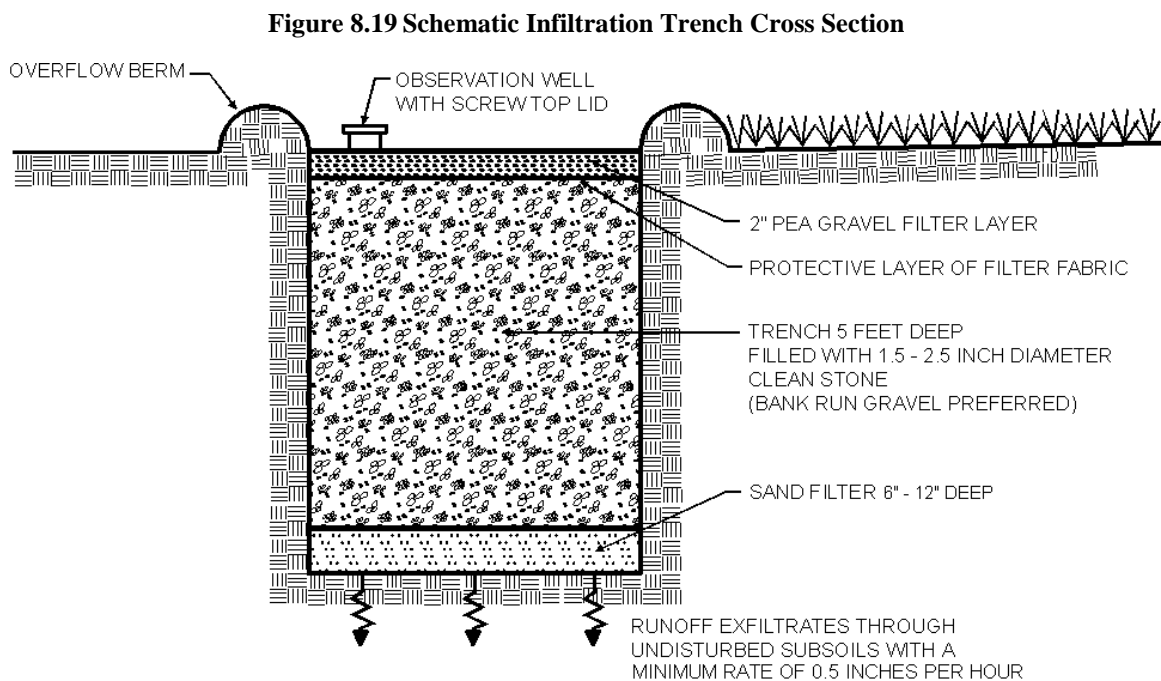

Section 8.5 Bioretention Design Example

This design example focuses on the design of a Bioretention area for a 4.5-acre catchment of Lake Center, a hypothetical commercial site located in Albany, NY. A five-story office building and associated parking are proposed within this catchment. The layout is shown in Figure 8.20. The catchment has 3.05 acres of impervious cover, resulting in 68% impervious cover. The pre-developed site is a mixture of forest and meadow. On-site soils are predominantly HSG “B” soils.

Figure 8.20 Lake Center Site Plan

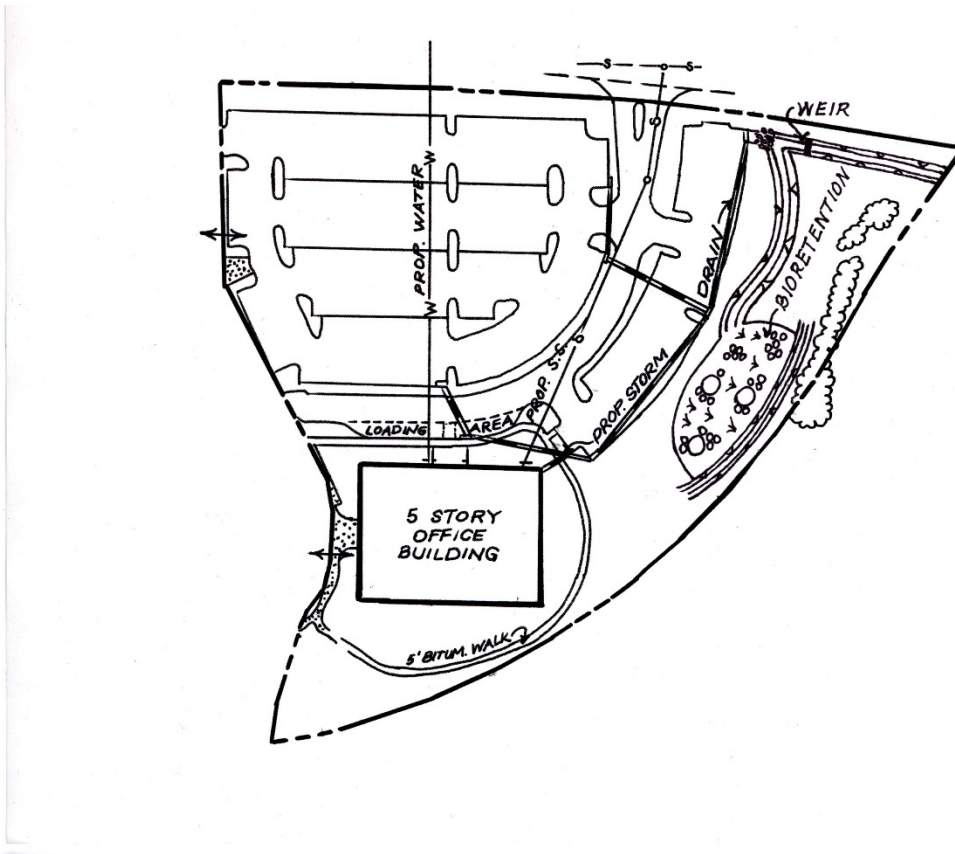

Hydrologic Data		
	Pre	Post
CN	58	83
t_c (hr)	0.44	0.10

Base Data

Location: Albany, NY

Site Area = Total Drainage Area (A) = 4.5 ac

Impervious Area = 3.05 ac; or $I = 3.05/4.50 = 68\%$

Soils Type "B"

This step-by-step example will focus on meeting the water quality requirements. Channel protection control, overbank flood control, and extreme flood control are not addressed in this example. Therefore, a detailed hydrologic analysis is not presented. For an example of detailed sizing calculations, consult section 8.1. In general, the primary function of bioretention is to provide water quality treatment and not large storm attenuation. As such, flows in excess of the water quality volume are typically routed to bypass the facility. For this example, the post-development 2-year and 10-year peaks are used to appropriately size the grass channel leading to the facility.

Step 1. Compute design volumes using the Unified Stormwater Sizing Criteria.

Design volumes are presented in Table 8.7 below.

Table 8.7 Design Hydrology					
Condition	CN	WQ _v	Q ₁	Q ₂	Q ₁₀
		ft ³	cfs	cfs	cfs
Pre-developed	58		0.3	0.6	4
Post-Developed	83	10,781	9	13	26

Step 2. Determine if the development site and conditions are appropriate for the use of a bioretention area.

Site Specific Data:

Existing ground elevation at practice location is 222.0 feet, mean sea level. Soil boring observations reveal that the seasonally high water table is at 211.0 feet and underlying soil is silt loam (ML). Adjacent channel invert is at 213 feet.

Step 3. Determine size of bioretention filter area.

$$A_f = (WQ_v) (d_f) / [(k) (h_f + d_f) (t_f)]$$

Where: A_f = surface area of filter bed (ft²)

d_f = filter bed depth (ft)

k = coefficient of permeability of filter media (ft/day)

h_f = average height of water above filter bed (ft)

t_f = design filter bed drain time (days) (2 days is recommended)

$$A_f = (10,781 \text{ ft}^3)(5') / [(0.5'/\text{day}) (0.25' + 5') (2 \text{ days})] \text{ (With } k = 0.5'/\text{day}, h_f = 0.25', t_f = 2 \text{ days)}$$

$$A_f = \underline{10,267 \text{ sq ft}}$$

Step 4. Set design elevations and dimensions.

Assume a roughly 2 to 1 rectangular shape. Given a filter area requirement of 10,267 sq ft, say facility is roughly 70' by 150'. Set top of facility at 219.0 feet, with the berm at 220.0 feet. The facility is 5' deep, which will allow 3' of separation distance over the seasonally high water table. See Figure 8.21 for a typical section of the facility.

Step 5. Size overflow channel.

Assuming the same channel configuration as in Section 8.3, use a 4' weir set 0.63' above the base of the overflow channel. The overflow channel will flow to the adjacent drainage channel, while the water quality storm will be diverted to the bioretention cell.

Step 6. Design Pretreatment

Size pretreatment to treat $\frac{1}{4}$ of the WQ_v . Therefore, treat $10,781 \times 0.25 = 2,695 \text{ ft}^3$.

Use a grass channel to provide pretreatment. The channel has a 4' width, 2% slope and 3:1 side slopes. During the water quality event, water flows at 1.3 fps, and at a depth of 0.6' (See Section 6.3). Adjust the length to be 25% of the length required to accommodate the WQ_v for 10 minutes as follows:

$$L = (1.3 \text{ fps})(600 \text{ s})(0.25) = 195 \text{ ft.}$$

Figure 8.21 Typical Section of Bioretention Facility

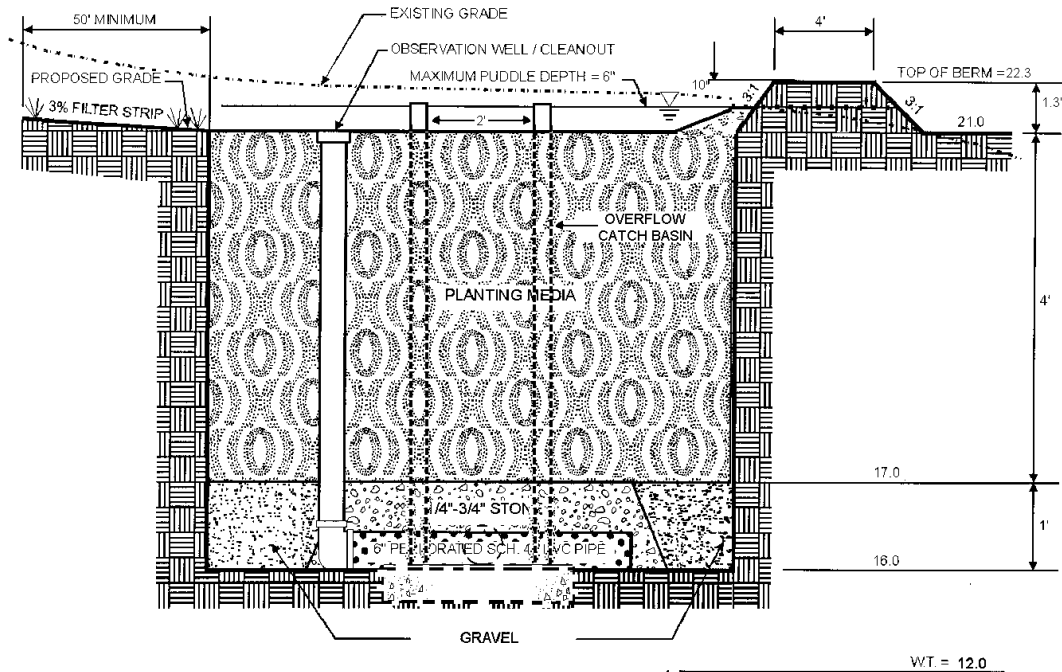

Step 7. Size underdrain area.

As a rule of thumb, the length of underdrain should be based on 10% of the A_f or 1,027 sq ft and a three-foot wide zone of influence. Using 8" perforated plastic pipes surrounded by a three-foot wide gravel bed, 10' on center (o.c.), yields the following length of pipe:

$$(1,027 \text{ sq ft})/3' \text{ per foot of underdrain} = \underline{342' \text{ of perforated underdrain}}$$

Step 8. Create overdrain design.

Size a square catch basin drop inlet to convey storms up to the peak discharge of the water quality event (4.6 cfs). Assume a 2' square, which is equivalent to an 8' weir. Rearrange the weir equation to calculate the depth of flow as follows:

$$H = [Q/(CL)]^{2/3}$$

Where,

$$Q = 4.6 \text{ cfs (flow)}$$

$$C = 3.1$$

$$H = (\text{depth of flow in feet})$$

$$L = \text{Weir Length (feet)}$$

Using this equation:

$$H = [4.6 \text{ cfs} / (3.1) / (8 \text{ ft})]^{2/3}$$

$$= 0.33 \text{ feet, or } 4''$$

Allow for a 6'' freeboard above the top of the catch basin. Therefore, set the elevation of the berm at 10'' above the top of the catch basin.

Step 9. Choose plants for planting area.

Choose plants based on factors such as whether native or not, resistance to drought and inundation, cost, aesthetics, maintenance, etc. Select species locations (i.e., on center planting distances) so species will not “shade out” one another. Do not plant trees and shrubs with extensive root systems (e.g., willows) near pipe work. A potential plant list for this site is presented in Appendix H.

Chapter 9: Redevelopment Activity

This chapter outlines alternative approaches for addressing stormwater management at projects that include the disturbance and reconstruction of existing impervious surfaces (i.e. redevelopment activity). The approaches set forth in this Chapter comply with the Department's technical standards.

The document includes the following sections:

9.1 Introduction

9.2 Scope and Applicability

9.3 How to Apply Alternative Stormwater Practices

9.4 Alternative Stormwater Management Practices – Proprietary Practices

Section 9.1 Introduction

Redevelopment of previously developed sites is encouraged from a watershed protection standpoint because it often provides an opportunity to conserve natural resources in less impacted areas by targeting development to areas with existing services and infrastructure. At the same time, redevelopment provides an opportunity to correct existing problems and reduce pollutant discharges from older developed areas that were constructed without effective stormwater pollution controls.

Redevelopment activities can range from large-scale redevelopment (e.g. reconstruction of a box store, mall, etc.), to much smaller building, parking lot or road reconstruction project. The proposed density of the large-scale projects can be high, resulting in space constraints to implement on-site stormwater controls. Added to this basic space constraint is the need to tie in to the existing drainage infrastructure, which may be at an elevation that does not provide enough head for certain stormwater management practices (SMPs). Other problems encountered in redevelopment include the presence of underground utilities, incompatible surrounding land uses, highly compacted soils that are not suitable for infiltration, and contaminated soils that require mitigation and can drive up project costs.

Because the technical standards contained elsewhere in this Manual were primarily intended for new development projects, compliance with the sizing criteria in full may present a challenge on projects that include redevelopment activities. Therefore, this chapter sets forth alternative sizing criteria for redevelopment activities. Implementation of this alternative sizing criteria will result in pollutant

New York State Stormwater Management Design Manual

Chapter 9: Redevelopment Activity

Section 9.1 Introduction

reductions over existing conditions with no practices in place, particularly when considering the cumulative effect of multiple projects.

For redevelopment activities located in critical environmental areas (see <http://www.dec.ny.gov/permits/6184.html>) and other sensitive environmental or regulated areas, all attempts should be made to seek compliance with the sizing criteria set elsewhere in this manual.

Key Terminology:

Alternative Sizing Criteria - The sizing criteria that can be achieved on construction projects that include redevelopment activities.

Alternative Stormwater Management Practice – Stormwater management practices that are outlined in this chapter for potential application for redevelopment activities and are designed and implemented in accordance with the recommendations in this chapter.

Disconnected impervious area - Impervious area that is not directly connected to a stream or drainage system, but which directs runoff towards pervious areas where it can infiltrate, be filtered, and slowed down.

Redevelopment Activity/Activities – Disturbance and reconstruction of existing impervious surfaces. This includes impervious surfaces that were removed within the last five (5) years.

Stormwater Management Practice (SMP) – A standard stormwater management practice that appears in Chapter 3 of this Manual, sized in accordance with Chapter 4 or 10, and designed in accordance with Chapter 6 or 10 of this Manual.

Stormwater sizing criteria – Criteria comprised of the following four elements: Water Quality Treatment, Runoff Reduction, Channel Protection, Overbank Flooding, and control of extreme storms as defined in Chapters 4 and 10 of this Manual for standard practices and any other requirements for enhanced treatment.

Total impervious area – This is the total area within the drainage area comprised of all materials or structures on or above the ground surface that prevents water from infiltrating into the underlying soils. Impervious surfaces include, without limitation: paved and/or gravel road surfaces, parking lots, driveways, and sidewalks; building structures; roof tops and miscellaneous impermeable structures such as patios, swimming pools, and sheds.

New York State Stormwater Management Design Manual

Chapter 9: Redevelopment Activity

Section 9.2 Scope and Applicability

Section 9.2 Scope and Applicability

The provision of stormwater management practices during redevelopment activities should follow an approach to balance between 1) maximizing improvements in site design that can reduce the impacts of stormwater runoff, and 2) providing a maximum level of on-site treatment that is feasible given the site constraints present where the redevelopment activities are occurring.

Under conditions where onsite treatment is not practicable, an appropriate off-site watershed improvement to offset the required level of control may be applied, in the presence of a regulated/permitted municipal stormwater management program. The off-site stormwater management approach is subject to applicable local agency approval for banking and trading of credits. This approach may not be an acceptable option in all cases. In addition, a SWPPP that incorporates this approach is considered to be not in conformance with the State's technical standards.

Requirements for installation of post construction controls set forth in current stormwater regulations do apply to construction projects that include redevelopment activities.

The sizing criteria described in this chapter apply to redevelopment activities only. If a construction project includes both new development and redevelopment activities, the stormwater management practices for the new development portion of the project must be designed in accordance with the sizing criteria in Chapter 4 or 10, and the redevelopment activities portion of the project is subject to the sizing criteria in Section 9.3.

If runoff from the reconstructed impervious area (i.e redevelopment activity) was being treated by an existing stormwater management practice that generally meets the criteria of one of the practices included in Chapters 5, 6, 9 or 10 of this manual, the final design must include WQv treatment equal to the treatment that was provided by the existing practice or the treatment options defined in Section 9.2.1 of this chapter, whichever provides the larger, more effective treatment.

9.2.1 Sizing Criteria

Note: The following sizing criteria apply to construction projects that include redevelopment activities.

A. Water Quantity controls shall be sized using the following options:

New York State Stormwater Management Design Manual

Chapter 9: Redevelopment Activity

Section 9.2 Scope and Applicability

I- If the redevelopment activities result in no change to hydrology that increases the discharge rate from the project site (Note: Include the redevelopment activity portion of a project and if applicable, any new development in the analysis), the ten-year and hundred-year criteria do not apply. This is true because the calculated discharge of pre-development versus post-development flows results in zero net increase. This consideration does not mean that existing quantity controls may be neglected in planned designs. Existing quantity controls must be maintained for post-development flow discharge control.

II- **Channel protection** for redevelopment activities is not required if there are no changes to hydrology that increase the discharge rate from the project site (Note: Include the redevelopment activity portion of a project and if applicable, any new development in the analysis). This criterion, as defined in Chapter 4 of this Manual, is not based on a pre versus post-development comparison. However, for redevelopment activities this requirement is relaxed. If the hydrology and hydraulic analysis for the project site shows that the post-construction 1-year 24 hour discharge rate and velocity are less than or equal to the pre-construction discharge rate, providing 24 hour detention of the 1-year storm to meet the channel protection criteria is not required.

B. Water Quality treatment objective shall be achieved using the following options. If there is an existing stormwater management practice located on the site that captures and treats runoff from the impervious area that is being disturbed, the water quality volume treatment option selected must, at a minimum, provide treatment equal to the treatment that was being provided by the existing practice(s) if that treatment is greater than the treatment required by options I - IV:

I- The plan proposes a reduction of existing impervious cover by a minimum of 25% of the total disturbed, impervious area. A reduction in site imperviousness will reduce the volume of stormwater runoff, thereby achieving, at least in part, stormwater criteria for both water quality and quantity. The final grading of the site should be planned to minimize runoff contribution from new pervious area onto the impervious cover. Effective implementation of this option requires restoration of soil properties in the newly created pervious areas. Soil restoration is achieved by practices such as soil amendment, deep-ripping, and de-compaction (See Section 5.1.6 Soil Restoration).

II- The plan proposes that a minimum of 25 % of the water quality volume (WQv) from the disturbed, impervious area is captured and treated by the implementation of standard SMP or reduced by application of green infrastructure techniques (see Chapter 5 of this Manual). For all sites that utilize structural SMPs, these practices should be targeted to treat areas with the greatest pollutant

New York State Stormwater Management Design Manual

Chapter 9: Redevelopment Activity

Section 9.2 Scope and Applicability

generation potential (e.g. parking areas, service stations, etc.). If the construction project includes both new development and redevelopment activities, treatment would be required for 25% of the existing, disturbed impervious area, however, the stormwater management practices for the new development portion of the project must be designed in accordance with the sizing criteria in Chapter 4. As with design of any practice, sizing of structures should be based on all areas contributing to the SMP. Construction projects that involve the redevelopment of a portion of the site, may choose diversion or flow splitters to be able to size the control structures for the reconstructed area only. For all sites that utilize green infrastructure techniques (See Table 3.2), a proposed plan is effective when runoff is controlled near the source and managed by infiltration, reuse, and evapotranspiration. Although encouraged, meeting the Runoff Reduction Volume (RRV) sizing criteria is not required for the redevelopment activity portion of a project.

III- The plan proposes the use of alternative SMPs to treat 75 % of the water quality volume from the disturbed, impervious area as well as any additional runoff from tributary areas that are not within the disturbed, impervious area. The use of alternative SMPs is discussed in Sections 9.3 and 9.4 of this chapter, which is focused on the accepted verified manufactured technologies.

IV- The plan proposes a combination of impervious cover (IC) reduction and standard or alternative SMPs that provide a weighted average of at least two of the above methods. The plan may provide a combination of the above options using the following calculation:

$$\% \text{WQv treatment by Alternative practice} = (25 - (\% \text{ IC reduction} + \% \text{ WQv treatment by Standard practice} + \% \text{ runoff reduction})) * 3$$

For example, water quality volume for the alternative practice for the following scenarios can be computed as follows:

5% IC Reduction, 20% Standard Practice, 0% Runoff Reduction, 0% Alternative Practice

5% IC reduction, 0% Standard practice, 0% Runoff Reduction, 60% Alternative practice

0% IC reduction, 5% Standard practice, 5% Runoff Reduction, 45% Alternative practice

5% IC reduction, 5% Standard practice, 5% Runoff Reduction, 30% Alternative practice

9.2.2 Performance Criteria

New York State Stormwater Management Design Manual

Chapter 9: Redevelopment Activity

Section 9.4 Alternative Stormwater Management Practices Proprietary Practices

The performance criteria of selected SMPs for redevelopment activities fall under three categories:

- Performance criteria for standard stormwater management practices as defined in Chapter 6 of this Manual, including required elements and design guidance details, must be applied in the design of the practices.
- Performance criteria for green infrastructure techniques as defined in Chapter 5 of this Manual, including design details and sizing methods, can be applied to meet the required RR_v criteria, and
- The alternative SMPs discussed in this chapter are to be used for redevelopment activities only. The performance criteria for alternative SMPs are based on the testing protocols and procedure set for verification of manufactured system by regulatory agencies

Section 9.3 How to Apply Alternative Stormwater Practices

When using an alternative SMP (i.e. proprietary practices), the WQ_v criteria shall be met by applying the sizing criteria in Section 9.2.1, Option B.III. to one of the alternative SMPs . Proprietary practices must be sized to capture and treat the WQ_v resulting from the contributing drainage area depending on whether it uses a volume-based or a rate-based sizing approach. For practices with a volume-based sizing approach, the practice must be sized to capture and treat 75 % of the WQ_v as defined in Chapter 4 of the Manual. For flow through practices, the practice must be sized to treat the peak rate of runoff from the WQ_v design storm, as defined in Chapters 4 and 10, and Appendix B of this Manual. The flow capacity identified in the verification process for the specific alternative practice must be greater than or equal to the calculated peak runoff rate from the WQ_v design storm. For off-line practices, the installation must include flow diversion that protects the practice from exceeding the design criteria.

Section 9.4 Alternative Stormwater Management Practices Proprietary Practices

Proprietary practices encompass a broad range of manufactured structural control systems available from commercial vendors designed to treat stormwater runoff and/or provide water quantity control. The focus of this profile sheet is on those proprietary practices that provide a level of water quality treatment that is acceptable for redevelopment activities. Manufactured treatment systems are often attractive during redevelopment activities because they tend to take up little space, often installed underground, and can usually be retrofitted to existing infrastructure.

Common proprietary systems include:

New York State Stormwater Management Design Manual

Chapter 9: Redevelopment Activity

Section 9.4 Alternative Stormwater Management Practices Proprietary Practices

- Hydrodynamic systems such as gravity and vortex separators –devices that move water in a circular, centrifugal manner to accelerate the separation and deposition of primarily sediment from the water. They are suitable for removal of coarse particles, small drainage areas, and are more effective in an offline configuration.
- Wet vaults – water-tight “boxes” that include a permanent pool and promote settling of particulates through detention and use of internal baffles and other proprietary modifications. A manufacturer’s recommendation may base the sizing of the vaults on water quality volume or flow rate, incorporate bypass, and sediment capacity.
- Media filters – surface or subsurface practices that contain filter beds containing absorptive filtering media that promotes settling of particulates as well as adsorption and absorption of other pollutants attracted to the characteristics of the proprietary filter media. Similar to traditional filtering systems, they are flow through systems which function based on contact of polluted stormwater with the filtering media, commonly contained in prefabricated devices. Commercially available media range from fabrics, activated carbon, perlite, zeolite, and combination of multiple media mixes, with varied treatment performances.
- Underground infiltration systems- prefabricated pipes and vaults designed as alternative treatment systems to capture and infiltrate the runoff. Various proprietary products are marketed as space saving structures utilizing the infiltration capacity of the sites. The offline underground infiltration modular structures have potential to perform at an acceptable treatment level when designed according to all the technical specifications of the standard infiltration systems. Manufactured infiltration systems are considered standard practices when all the required elements, design guidance, soil testing, siting, and maintenance requirements, as defined in the Design Manual, are followed.

9.4.1 Evaluation of Alternative Practices

As a group, the performance of manufactured stormwater management practices (SMPs) have been verified thus far only to a limited extent, with a majority of the verification studies limited to laboratory testing. Where verification data does exist, they generally indicate that these practices do not meet both the 80% total suspended solids (TSS) and 40% total phosphorus (TP) removal efficiency target that is specified in Chapter 3 of this Manual. However, proprietary practices that have been certified by specific verification sources and can demonstrate that they provides some level of water quality treatment, are allowed for redevelopment activities in New York State. This allowance is conditioned upon the system being operated at the specific tested design flow rate, defined based on the verified performance of each specific system. Based on the conclusions of the verification sources, it is believed that these treatment systems have the capability of achieving an acceptable TSS removal efficiency in field applications.

NYSDEC’s evaluation of proprietary systems for demonstration of minimum removal efficiency for redevelopment activities are based on one of the following stormwater management practice

New York State Stormwater Management Design Manual

Chapter 9: Redevelopment Activity

Section 9.4 Alternative Stormwater Management Practices Proprietary Practices

evaluation systems: The U.S. Environmental Protection Agency (EPA) Environmental Technology Verification Program, the state of Washington Technology Assessment Protocol - Ecology (TAPE), the Technology Acceptance Reciprocity Partnership Protocol (TARP), the state of Maryland Department of the Environment, , and several other evaluation systems.

The proposed manufactured treatment systems that are verified or certified through ETV, TAPE, or TARP (primarily New Jersey Corporation for Advanced Technology) process and meet the criteria stated above are allowed for redevelopment activities in New York State. Proposed manufactured treatment systems that are not verified yet may be considered for acceptance in New York State if verified at any time through one these verification sources.

All the manufactured treatment systems must be sized appropriately to provide treatment for the water quality volume or the runoff from the entire contributing area. Due to the proprietary nature of the practices, designers are responsible to ensure that manufacturer's recommendations concerning all the design details such as structural integrity, configuration, assembly, installation, operation, and maintenance of the units are followed. Designers are also responsible to address, at minimum, all the relevant requirements set by New York State standards such as quantity controls, pretreatment, bypass, overflow, head configuration, inflow/outflow rates, maintenance, separation distance, accessibility, and safety issues concerning the selected practice.

9.4.2 Recommended Application of Practice

Many proprietary systems are useful on small sites and space-limited areas where there is not enough land or room for other structural control alternatives. Proprietary practices can also be reasonable alternatives where there is a need to tie in to the existing drainage infrastructure, where site elevations limit the head for certain stormwater management practices (SMPs). Hydrodynamic separators are generally more effective on sites with potential loading of coarse particulates. While specific media filters may be suitable in most conditions, infiltration systems must be limited to sites with the A or B hydrologic soil groups.

9.4.3 Benefits

The benefits of using proprietary practices will vary depending on the type of practice, but may include:

- Reduced space requirements for practices located below grade.

New York State Stormwater Management Design Manual

Chapter 9: Redevelopment Activity

Section 9.4 Alternative Stormwater Management Practices Proprietary Practices

- Reduced engineering and design due to prefabricated nature of systems and design support and tools provided by manufacturer.
- Spill containment and control capabilities

9.4.4 Feasibility/Limitations

Depending on the proprietary system, the following factors may be considered as a limitation:

- Limited performance data. Data that does exist suggest these practices don't perform at the same level as the suite of standard practices in Chapters 3 and 6 of this Manual, particularly with regard to nutrient load reduction.
- Application constraints such as limits to area draining to a practice, due to pre-manufactured nature of products.
- High maintenance requirements (e.g., need for specialized equipment, confined space entry training, frequency of recommended maintenance, and cost of replacement components) that often are ignored or forgotten because many practices are underground and out of sight.
- Higher costs per treated area than other structural control alternatives, but this can be offset by value of land not needed due to subsurface nature of many proprietary practices.
- Concern over mosquito breeding habitat being provided by practices that have wet sumps as design components.

9.4.5 Sizing and Design Guidance

Sizing and design guidance will vary based on the product being used. Since sizing criteria is integral to the verified performance of manufactured practices, designers should refer to the capacities and flow rates associated with the models (sizes) of the manufactured SMPs identified by the verification source.

The New York State design standards calls for small storm hydrology and the use of Simple Method for hydrology calculation. For practices with volume-based sizing approaches, sizing should be performed to meet the water quality volume as defined in Section 4.2 of this Manual. For rate or flow-based sizing approaches, sizing should be performed based on the peak rate of discharge for the water quality design storm, as described in Appendix B of this Manual.

Some proprietary practices can be designed on-line or off-line. On-line practices typically have built-in bypass capabilities. Flow through systems, which do not have built-in bypass must be designed as off-line systems

New York State Stormwater Management Design Manual

Chapter 9: Redevelopment Activity

Section 9.4 Alternative Stormwater Management Practices Proprietary Practices

It is important for designers to specify proprietary practices based on their treatment capacities (CASQA, 2003). Since hydraulic capacity can be as much as ten times that of the treatment capacity, designer must ensure that hydraulic load does not exceed the performance rate defined in the verification process. The above applies to all design elements that affect the performance rate. Some examples of such design elements are head, orifice sizing, oil storage or sediment storage capacities, baffle configuration, or screen size.

Practices with a volume-based sizing approach must be sized to capture and treat 75 % of the WQv as defined in Chapter 4 of the Manual. Flow through practices must be sized to the peak rate of runoff from the WQv design storm, as defined in Chapters 4 and 10, and Appendix B of this Manual. For off-line practices, the installation must include flow diversion that protects the practice from exceeding design criteria.

9.4.6 Environmental/Landscape Elements

There are few or no environmental or landscaping elements that designers can consider with most proprietary treatment practices. They are frequently absent or predetermined by the manufacturer. The use of land area above the facility needs to be selective and manufacturer design codes must be strictly followed.

9.4.7 Maintenance

Maintenance is a critical component to ensure proper functioning of proprietary practices. Most manufacturers provide maintenance recommendations. When these schedules are not followed, proprietary practices can be expected to fail. Maintenance is often overlooked with proprietary products because they are underground and out of view. Most proprietary practices require a quarterly inspections and cleanouts at a minimum. In addition, specialized equipment (e.g., vactor trucks and boom trucks) may be required for maintaining certain proprietary products. Similar to standard practices, a maintenance agreement between the municipality and the property owner should be executed to clearly identify required or recommended maintenance activities, schedules, reporting, and enforcement procedures. Please also refer to maintenance requirements defined in Chapter 3 of this Design Manual.

9.4.8 Cost

New York State Stormwater Management Design Manual

Chapter 9: Redevelopment Activity

Section 9.4 Alternative Stormwater Management Practices Proprietary Practices

Proprietary systems are often more costly than other SMPs on a per-area-treated basis, but this is sometimes made up for in space savings. Manufacturers should be contacted directly for unit pricing, which will vary based on size of unit specified. As a rule of thumb, installation cost of most proprietary practices will range from 50 to 100% of the unit cost (CASQA, 2003). Other proprietary practices, may not have high initial capital or installation costs, but require frequent (i.e., at least quarterly) replacement of component parts for proper operation.

References/Further Resources

Atlanta Regional Commission. 2001. Georgia Stormwater Management Manual.
www.gastormwater.com/.

American Society of Civil Engineers (ASCE) Web site, "ASCE/EPA Stormwater Best Management Practices Nationwide Database," <http://bmpdatabase.org/>

California Stormwater Quality Association (CASQA). 2003. California Stormwater BMP Handbook.
www.cabmphandbooks.com.

Center for Watershed Protection. 2001. "Assessment of Proprietary and Nonproprietary Products for Pretreatment of Larger Discharges", www.stormwatercenter.net.

Environmental Technology Acceptance and Reciprocity Partnership (ETARP). 2000. Six State MOU, Interstate Reciprocity Technology Acceptance, Tier I Guidance.

ETV Verification Protocol Stormwater Source Area Treatment Technologies, Draft 4.0, March 2000.

New Jersey Corporation for Advanced Technology, Verification Process Web site.
<http://www.njcat.org/verification>. Accessed -November 2006.

Washington State Department of Ecology. Stormwater Treatment Technologies,
<http://www.ecy.wa.gov/programs/wq/stormwater/newtech/technologies.html>. Accessed March 2006

Chapter 10: Enhanced Phosphorus Removal Supplement

Section 10.1 Introduction and Overview

The goal of this chapter is to address design standards for “enhanced phosphorus removal” for projects in phosphorus-limited watersheds. It has been determined that enhanced phosphorus removal is required to meet water quality objectives established for these watersheds. In addition, this chapter encourages the use of upstream controls as a primary means for reducing runoff volumes and their associated pollutant loads.

The discussion presented in this section of the supplement provides a short description of the sources, environmental fate and transport, and technical aspects of designing treatment systems for further reducing loads and concentrations of phosphorus in runoff beyond what would potentially be achieved based on the minimum statewide standards established in this Design Manual. This section also presents additional treatment performance standards for enhanced phosphorus removal.

10.1.1 Description and Properties of Phosphorus

Phosphorus is an essential nutrient for all life forms and can also be the limiting nutrient for the primary productivity of a body of water. However, increased amounts of phosphorus entering surface waters can stimulate excessive algae growth, and associated water quality problems such as decreased water clarity, large daily variations in dissolved oxygen, disagreeable odors, habitat loss and fish kills.

Phosphorus occurs in natural waters almost solely as phosphates. In rainfall runoff, the predominant (> 30%) phosphate forms are the orthophosphate anions HPO_4^{-2} and $\text{H}_2\text{PO}_4^{-1}$ and to a lesser degree (10%) magnesium phosphate (MgHPO_4 [aq]) and calcium phosphate (CaHPO_4 [aq]). Phosphorus is most often measured in one of two forms: total phosphorus (TP) and reactive dissolved phosphorus (RDP). While RDP is largely a measure of orthophosphate, TP includes inorganic and organic forms of phosphorus. The magnitude and phases/species are site, watershed and land-use specific. Depending on pH, hydrology, concentration of phosphate species, concentration of calcium and magnesium, particulate solids, redox and residence time, partitioning of phosphorus in rainfall runoff between the particulate-bound and dissolved fractions can vary from 20% to more than 90% particulate. Solubility of phosphorus species in rainfall runoff ranges from >80% at a pH of 6 to <1% at a pH of 8. Despite the wide range of speciation, partitionings, and solubility, phosphorus species are generally particulate bound, particularly within the settleable and sediment fractions. Approximately half the phosphorus in

New York State Stormwater Management Design Manual

Chapter 10: Enhanced Phosphorus Removal Supplement

Section 10.1 Introduction and Overview

residential and commercial areas is particulate, with larger fractions of particulate bound phosphorus likely to be found in industrial and open space areas. The National Stormwater Quality Database (NSQD) reported total and dissolved phosphorus as follows:

Table 10.1 Phosphorus Concentrations by Land Use				
	Residential	Commercial	Industrial	Open Space
Average Total P, mg/L (# of obs)	0.41 (963)	0.34 (446)	0.45 (434)	0.59 (46)
Average Dissolved P, mg/L (# of obs)	0.20 (738)	0.18 (323)	0.16 (325)	0.16 (44)
Approximate % Dissolved:	49	53	36	27
Approximate % Particulate:	51	47	64	73

Note: parentheses represent number of samples used to derive average.

Sources of Phosphorus

Natural phosphorus-bearing minerals are the chief source of phosphorus for industrial and agricultural purposes. The inorganic phosphate and organophosphate components of total phosphorus are typically derived from soil, plant and animal material. In nature, phosphorus has almost no gaseous forms, and so the major transport mechanism is typically by water flow. Nevertheless, significant amounts can be transported via the atmosphere, associated with dusts.

Significant traditional point sources of phosphorus include food-processing industries, sewage treatment plants, leachate from garbage tips and intensive livestock industries (e.g., animal feedlots, dairy operations, horse pastures and large poultry operations). Diffuse sources of phosphorus, although some (e.g., urban, industrial and construction) are now considered point sources from a regulatory standpoint, are often better described as nonpoint. Inorganic phosphate and organophosphate components of total phosphorus associated with undisturbed and agricultural land uses are primarily due to the use of fertilizers and manures and, to a lesser extent, the use of phosphorus-containing pesticides on agricultural lands.

In urban and suburban rainfall runoff, phosphorus sources include detergents, fertilizers, natural soil, flame retardants in many applications (including lubricants), corrosion inhibitors and plasticizers. In areas with high phosphorus content in soils, deposition of sediment due to construction or other land-

New York State Stormwater Management Design Manual

Chapter 10: Enhanced Phosphorus Removal Supplement

Section 10.1 Introduction and Overview

disturbance activities can also represent a significant source. Automobile lubricant emissions, food products, lawn and garden fertilizers and various household cleaners, paints, fabrics and carpets contain phosphates which will be transported by runoff. The widespread use of products containing phosphorus in areas exposed to precipitation and runoff can contribute significantly to concentrations in receiving waters.

Finally, significant vegetation removal, land clearing, tilling or grading, soil compaction or the addition of impervious surfaces can result in increased phosphorus delivery due to higher runoff volume and intensity increasing the flushing of phosphorus from land surfaces or, potentially, increasing erosion of downstream water courses, which can be of concern in areas with high phosphorus contents in soils.

Environmental Fate and Transport of Phosphorus

The sources, dispersion, transport and fate of phosphorus in the environment is extremely complex, in some ways even more so than for nitrogen, because of the complexity of its forms and conversion pathways in the solid form. The oxidation-reduction status (usually expressed as redox potential) of the environment plays a critical role in the forms, and hence availability, of phosphorus. This status is critically dependant on microbial activity (which, if at a sufficient level, causes anaerobic conditions to develop) but in turn is dependent on the amount of readily assimilable organic matter present. High total phosphorus levels, together with high total nitrogen levels and in conjunction with other necessary nutrients and favorable physical characteristics of aquatic environments, can result in plant and algal blooms. (Burton, 2001)

Most total phosphorus is transported by processes such as runoff and stream flow and, to a lesser degree, in groundwater flow, although wind also transports components of total phosphorus around the landscape.

10.1.2 Enhanced Phosphorus Treatment Processes

Enhanced phosphorus treatment specifically refers to a measurable, significant improvement in phosphorus-treatment performance over the design methodology used for standard practices.

As receiving water quality is the ultimate measure of stormwater management practice performance, enhanced performance is best defined by the following:

1. Prevention of runoff can be a highly effective means for reducing the total loads of phosphorus generated as well as the size and, therefore, cost of downstream controls

New York State Stormwater Management Design Manual

Chapter 10: Enhanced Phosphorus Removal Supplement

Section 10.1 Introduction and Overview

- while increasing the water quality efficiency. Reducing imperviousness and achieving hydraulic disconnection of impervious areas are both critical to reducing runoff volumes. Prevention is best addressed through hydrologic source control by maximizing evapotranspiration and infiltration. This could be achieved through small-scale distributed controls, such as raingardens, stormwater planter boxes, biofiltration areas, draining roof runoff to landscaped areas, draining driveways and walkways to landscaped areas, greenroofs, rainwater cisterns, use of porous pavements or minimization of site soil compaction.
2. Performance of a stormwater management practice is directly related to the quantity of water that is effectively treated by the system (i.e., the amount of flow that is not bypassed or that exceeds the system's effective treatment rates). This element of performance is as important as the effectiveness of the system itself. Stormwater management practices are rarely designed to control 100% of the runoff volume from all events. Therefore, effective bypass (which in this context includes flows diverted from the treatment system as well as discharges routed through the system in excess of the effective treatment flow rate) of some portion of the long-term hydrograph is expected. Analysis of the long-term continuous precipitation/runoff hydrology for a site can help optimize the hydraulic design of a treatment system in order to achieve the desired level of runoff capture. Target "capture rates" (e.g., the percentage of runoff that receives the desired treatment) may depend on several factors, including the sensitivity of receiving waters, desired water quality of discharge from the site (i.e., both treatment-system effluent and any bypass) or the level of downstream hydraulic control needed.
 3. The ability of a treatment system to achieve low concentrations (for receiving waters that are concentration limited, such as rivers and streams) and/or low relative loading (for receiving waters that are mass limited, such as lakes and reservoirs) of target pollutants is an essential element of performance. The best means for evaluating this performance is through statistical quantification of observed effluent concentrations and loads. The expected effluent quality can be seasonally affected, as nutrient export can potentially occur as a result of decay of biological matter during winter months and can have a more significant effect on receiving waters when they are phosphorus limited relative to biological growth (i.e., during the summer).
 4. The expansion of the classic definition of treatment-system performance to include hydrologic source control, hydraulic and hydrologic function and the ability of a system to achieve high-quality effluent are essential for providing sound information and direction on how to design treatment systems to minimize effects of phosphorus in runoff from new development, redevelopment and retrofits on receiving waters.

Furthermore, long-term phosphorus removal performance is particularly sensitive to proper maintenance; particularly important maintenance functions include:

- Sediment removal
- Vegetation control
- Landscaping practices

New York State Stormwater Management Design Manual

Chapter 10: Enhanced Phosphorus Removal Supplement

Section 10.1 Introduction and Overview

- Gross floatable organics, litter and garbage control
- Design consideration for vegetative systems.

These elements are key components in helping to achieve optimal phosphorus uptake and short and long term performance.

Treatability for Phosphorus

Treatability for phosphorus is a function of partitioning (particulate vs. aqueous). For particulate-bound phosphorus, treatability is a function of particle distribution across the gradation of particle sizes and densities. Based on the best available data, it has been observed that particles less than 10 μm tend to have substantially higher associated phosphorus concentrations than larger particle sizes. This suggests that those practices capable of removing smaller particle sizes may provide greater treatment effectiveness overall. (Pitt, 2004)

In aqueous systems, treatability is a function of concentration and speciation. Phosphorus can readily undergo surface complexation reactions, be adsorbed or precipitated. Media or soils containing iron, aluminum or hydrated Portland cement can be very effective in separating phosphorus species through surface complexation or precipitation. However, complexation or partitioning to engineered media or particulate matter can be reversible, and particulate-bound phosphorus can be a chronic threat, especially in a cyclic redox environment.

When bound to organic or inorganic particles, viable unit operations include sedimentation and filtration, which may be augmented by pretreatment coagulation/flocculation where feasible. Management and maintenance of all unit operations, including physical, chemical and biological processes, is critical to ensure removal of phosphorus from stormwater.

Table 10.2 identifies the most appropriate unit operations or processes for treatment of particulate-bound or dissolved phosphorus. (Strecker, 2005)

Table 10.2 Treatment of Particulate Bound or Dissolved Phosphorus	
Form	Unit Operation or Process For Treatment
Particulate bound	Sedimentation, filtration, coagulation-flocculation
Dissolved	Adsorption, surface complexation, precipitation, biological uptake and separation

10.1.3 Treatment Performance Goals

The design criteria provided in this supplement are based on extensive research into the relationship between design factors and performance and represent the state-of-the-practice in science and engineering. The following goals have been established as metrics for determining appropriate criteria for enhanced phosphorus removal:

Goal 1 - Reduce runoff volumes by requiring that each project assess the feasibility of hydrological source controls and, where feasible, implement those source controls. For each proposed plan, provide the reasons for acceptance and rejection of the various controls.

Goal 2 - Achieve less than 15% treatment bypass of the long-term runoff volume. This goal is defined by running a continuous simulation model that ensures that the SMP does not effectively bypass more than 15% of the runoff from the site.

Goal 3 - For flows that are treated by the system (i.e., flows that are not effectively bypassed), median effluent concentration of particulate phosphorus shall be at or below 0.1 mg/L. This effluent concentration of particulate phosphorus is equivalent to a net removal of particulate phosphorus of 80%, given a median influent concentration of 0.5 mg/L.

Goal 4 - For flows that are treated by the system (i.e., flows that are not effectively bypassed) the median effluent concentration of dissolved phosphorus shall be at or below 0.06 mg/L. This effluent concentration of dissolved phosphorus is equivalent to a net removal of dissolved phosphorus of 60%, given a median influent concentration of 0.15 mg/L.

Effluent quality goals for particulate and dissolved phosphorus are based on analysis of available empirical influent and effluent water quality data for a variety of treatment systems and operational conditions (e.g., catchment characteristics, climate). (Pitt, 2004)

The development of the design criteria is discussed in detail in Section 10.2 and is based on continuous simulation modeling of hydrology and hydraulics, as well as process-level analysis of the water quality performance of specific treatment systems when properly designed. The analysis is also based on particle size distributions from available data as well as the best available information on solid-phase phosphorus concentrations.

New York State Stormwater Management Design Manual

Chapter 10: Enhanced Phosphorus Removal Supplement

Section 10.2 Analysis of Methods and Summary of Conclusions for Sizing Standards

The alternative sizing criteria provided in Section 10.3 and design criteria provided in Section 10.4 are intended to serve as an acceptable means for achieving the above stated goals. Section 10.5 presents three design examples to demonstrate how the standards provided in this supplement can be used in engineering practice.

Section 10.2 Analysis of Methods and Summary of Conclusions for Sizing Standards

10.2.1 Introduction

The selection of alternate sizing standards for enhanced phosphorus treatment takes into account the expected impact on effluent quality relative to the defined performance goals, construction feasibility and the applicability of the alternate sizing criteria to a broad range of watershed types (e.g., highly impervious, highly pervious). These non-performance factors are used to help optimize the selection of alternate design standards. These design standards are suitable for enhanced phosphorus treatment and are similar in terms of implementation to those of standard practices. Design examples are provided in Section 10.5 of this supplement, to help clarify how the alternate sizing criteria may be incorporated into the existing design methodology.

10.2.2 Analysis of Existing and Alternate Design Standards

Separate analyses were performed for storage and flow-through systems to help assess the relative difference in treatment performance between systems sized according to the current standards as specified in this Manual and alternate sizing criteria.

Analysis of Storage Systems Treatment Performance

Storage systems are classified as those treatment practices that provide hydrologic and pollutant control via temporary storage of runoff volume and are typified by basins of various designs and configurations. While outlet design, basin geometry and other factors may differ, the overall hydraulic and treatment function of storage systems are generally similar.

It is well established that the primary treatment mechanism employed by storage systems is particulate settling, which is suitable for treatment of sediment and particulate-associated pollutants, including the particulate form of phosphorus. In terms of treatment practice design, particulate settling effectiveness in storage systems is governed in part by the depth of the water column and the duration over which water remains in the basin (under relatively quiescent conditions), among other factors. A number of

New York State Stormwater Management Design Manual

Chapter 10: Enhanced Phosphorus Removal Supplement

Section 10.2 Analysis of Methods and Summary of Conclusions for Sizing Standards

non-design factors also influence particulate treatment performance, including the size and character of the suspended particulates. Select storage systems such as Wet Ponds (P-2) or Shallow Wetlands (W-1) are designed such that the WQ_v of the system remains full (i.e., 100% of the WQ_v is in the permanent pool), while others such as Wet Extended Detention Ponds (P-3) divide the WQ_v between permanent pool and an extended detention volume that drains following each runoff event.

It is important to note that large treatment systems may not always be appropriate for all sites. Sizing and design of large systems must take into account potential site constraints (e.g., height of water table relative to basin), construction and maintenance cost, site hydrology (e.g., need for flow control may require greater extended detention volume) and aesthetic criteria, among other factors. It is noted that the best means for reducing treatment system size is through the prevention of runoff as a part of the site-planning process.

Analysis of Flow-Through Systems Treatment Performance

Flow-through systems are different from storage systems in that these practices are not intended to capture and hold the runoff volume for a significant length of time, but rather they provide treatment through physical, chemical and/or biological mechanisms that act on the runoff as flows are routed through the system. As such, flow-through systems tend to be smaller in scale than storage systems and designed more for water quality treatment than flow attenuation.

The unit-process treatment mechanisms employed by various flow-through systems differ depending on their design and intended function, and the level of knowledge within the stormwater field of these mechanisms is still relatively limited. The factor that may be most relevant to the overall treatment performance of flow-through systems is hydraulic performance (i.e., the proportion of the total runoff volume treated). In the case of filtration and infiltration systems, the rate at which captured runoff is conveyed through the system is essentially constrained to the effective treatment flow rate of the system. A majority of flow-through systems are positioned as offline practices, equipped with a method for bypassing flows in excess of the treatment flow rate.

Analysis of the existing and alternate sizing methods for flow-through systems focused on the hydraulic performance as an approximation of overall treatment performance. As with the analysis of storage systems, continuous simulation models (incorporating long-term regional climatic data) were used to provide a relative comparison of performance.

10.2.3 Results of Analysis of Existing and Alternate Design Standards

The analysis of storage and flow-through systems provided a relative comparison of estimated overall treatment performance of stormwater management practices designed to the existing standards and to alternate standards. The results of this analysis indicate that the current method for sizing treatment systems is expected to yield stormwater management practices with WQ_v 's that are insufficient to meet the enhanced phosphorus treatment performance goals.

Results of the continuous simulation analysis, as well as evaluation of empirical data reported for numerous different storage-type treatment practices nationwide, strongly suggest that sizing of the permanent pool is expected to have a significant influence on particulate treatment performance. Ponds with larger permanent pools relative to runoff volume result in improved settleable solids removal.

Analysis of runoff conditions for catchments with varying degrees of imperviousness reveals that, particularly during more intense storms or periods of frequent rainfall, the contribution of runoff volume from pervious areas can be significant. In addition, the 90% rainfall depth specified in the Design Manual may not provide sufficient storage to acceptably minimize reduced efficiency resulting from decreased detention time (in storage systems) or bypass (in flow-through systems).

The alternate approach to sizing the WQ_v presented in this supplement uses standard hydrologic calculations from the SCS Method ([Technical Release 20](#) and [Technical Release 55](#)) to account for runoff from the entire catchment, as opposed to using the impervious fraction only. Several design storm criteria in addition to the selected sizing were evaluated, taking into account both estimated long-term performance and the variety of additional optimization factors previously noted.

The alternate WQ_v calculation for enhanced phosphorus treatment is considered to be suitable for both storage and flow-through systems and applicable to catchments that range from highly impervious to highly pervious. This alternate approach is as follows:

WQ_v = the estimated runoff volume (acre-feet) resulting from the 1-year, 24-hour design storm over the post-development watershed

Section 10.3 Stormwater Sizing Criteria

10.3.1 Introduction

New York State Stormwater Management Design Manual

Chapter 10: Enhanced Phosphorus Removal Supplement

Section 10.3 Stormwater Sizing Criteria

Table 10.3 summarizes the stormwater sizing criteria to meet pollutant removal goals for enhanced phosphorus removal. The remainder of this section describes the modified sizing criteria in detail and presents instructions on how to properly compute and apply the standard to meet the performance goals.

Table 10.3 New York Stormwater Sizing Criteria for Enhanced Phosphorus Removal	
Water Quality (WQ_v)	WQ _v = estimated runoff volume (acre-feet) resulting from the 1-year, 24-hour design storm over the post development watershed (See Figure 10.1).
Runoff Reduction Volume (RRV)	Refer to existing requirements. (Chapter 4, Table 4.1) Runoff reduction applies to the WQ _v resulting from one-year, 24-hour storm . The minimum RRV is calculated using the one (1) year 24 hour storm and the Specified Reduction Factor (see minimum RRV formula on page 4-6 in Section 4.3).
Channel Protection (Cp_v)	Refer to existing requirements. (Chapter 4, Table 4.1)
Overbank Flood (Q_p)	Refer to existing requirements. (Chapter 4, Table 4.1)
Extreme Storm (Q _f)	Refer to existing requirements. (Chapter 4, Table 4.1)

10.3.2 Water Quality Volume (WQ_v) for Enhanced Phosphorus Removal

The Water Quality Volume (WQ_v) for enhanced phosphorus removal is designed to capture the estimated runoff resulting from the 1-year, 24-hour design storm over the post- development watershed. This alternate approach to sizing the WQ_v uses standard hydrologic calculations from the SCS Method (Technical Release 20 and Technical Release 55) to account for runoff from the entire catchment, both impervious areas and pervious areas. Contour lines for the 1-year, 24-hour design storm rainfall events are presented in Figure 4.2.

By implementing an environmental design approach and incorporating green infrastructure practices, a site's contributing impervious area can be reduced and the hydrology of the pervious areas altered. These practices will result in lower curve number (CN) and lower WQ_v.

10.3.3 Channel Protection Volume (Cp_v) for Enhanced Phosphorus Removal

Stream channel protection volume (Cp_v) requirements are designed to protect stream channels from erosion. In New York State, the channel protection volume (Cp_v) is accomplished by providing 24-hour extended detention of the one-year, 24-hour storm event. One way that this can be accomplished is by ensuring that the time difference between the center of mass of the inflow hydrograph (entering

New York State Stormwater Management Design Manual

Chapter 10: Enhanced Phosphorus Removal Supplement

Section 10.3 Stormwater Sizing Criteria

the SMP) and the center of mass of the outflow hydrograph (leaving the SMP) is a minimum of 24 hours (see Section 4.3 for complete discussion of channel protection volume).

For enhanced phosphorus removal, the WQ_v is sized for the one-year, 24-hour event. Therefore, the only additional requirement necessary to meet for Cp_v is to provide 24-hour extended detention of the WQ_v . In some SMPs (e.g., the Wet Extended Detention Pond), the Cp_v requirements are achieved through WQ_v sizing techniques (i.e., the extended detention orifice is sized to release the ED_v within 24 hours). In other SMPs (e.g., the Wet Pond) the requirements are not inherent in the design and must be achieved using other means (i.e., provided above the WQ_v).

Once a pond has been sized to meet the WQ_v requirement, a TR-55 and TR-20 (or approved equivalent) model may be used to determine center of mass detention time. By modifying the pond volume and the elevation and size of the outlet structure(s), in a trial and error fashion, the Cp_v requirement can be met. Alternatively, the methodologies in Appendix B can be followed to ensure Cp_v requirement is met.

10.3.4 Sizing to Meet Treatment Performance Goals

The method for sizing standard practices is expected to yield stormwater treatment systems with WQ_v insufficient to meet the enhanced phosphorus treatment goals. This section will explain what new design standards were implemented to meet the enhanced phosphorus treatment goals.

Goal 1. Reducing Runoff Volumes

For each project, the designer must assess the feasibility of hydrological source controls and reduce the total water quality volume by source control, implementation of runoff reduction techniques, or standard SMPs with runoff reduction capacity (RR), according to the process defined in Chapters 3 and 4 of this Design Manual. Each proposed plan must include a rationale for acceptance and rejection of the various controls.

Source controls include measures for reducing runoff generation and/or available phosphorus levels, as well as distributed controls located within the watershed that are designed to target specific sources of phosphorus in runoff before it is transported downstream. Effective use of source controls can help reduce or even eliminate the need for larger, more costly downstream structural controls and associated operation and maintenance obligations.

New York State Stormwater Management Design Manual

Chapter 10: Enhanced Phosphorus Removal Supplement

Section 10.3 Stormwater Sizing Criteria

Runoff reduction is an effective means for preventing pollutant loads to receiving waters and has a number of positive effects on a site's water balance. Reducing runoff volume is the primary goal of green infrastructure approaches and structural infiltration practices (e.g., infiltration basins or trenches). In new development, where preservation of green space is possible and site configuration is flexible, runoff reduction techniques must be used to maximize infiltration and evapotranspiration. The process of planning and design according to runoff reduction techniques is defined in Chapter 3 of this Manual. Opportunities for and benefits of incorporating runoff reduction techniques can be gauged in part by assessing the hydrologic properties of native soils, specifically the hydrologic soil group (HSG).

Projects that cannot meet 100% of runoff reduction requirement due to site limitations that prevent the use of an infiltration technique and/or infiltration of the total WQv shall identify the specific site limitations in the SWPPP. Typical site limitations include: seasonal high groundwater, shallow depth to bedrock, and soils with an infiltration rate less than 0.5 inches/hr.

Construction activities that cannot achieve 100% reduction of the total WQv due to site limitations shall direct runoff from all newly constructed impervious areas to a RR technique or standard SMP with RRv capacity unless infeasible. In no case shall the runoff reduction achieved from the newly constructed impervious areas be less than the minimum runoff reduction volume (RRv_{min}) determined by the following equation:

$$RRv_{min} = \frac{P_{1yr} * \bar{R}_v * Aic * S}{12}$$

Where:

RRv_{min}	=	Minimum runoff reduction volume required from impervious area (acre-feet)
P_{1yr}	=	1-year storm event (in)
\bar{R}_v	=	$0.05+0.009(I)$ where I is 100% impervious
Aic	=	Total area of new impervious cover
S	=	Hydrologic Soil Group (HSG) Specific Reduction Factor (S)

The specific reduction factor (S) is based on the HSGs present at a site. The following lists the specific reduction factors for the HSGs:

HSG A = 0.55

HSG B = 0.40

New York State Stormwater Management Design Manual

Chapter 10: Enhanced Phosphorus Removal Supplement

Section 10.3 Stormwater Sizing Criteria

HSG C = 0.30

HSG D = 0.20

The remaining of WQv generated from 1-yr storm that exceeds the capacity of the implemented RR techniques or other SMPs with RRv capacity or both must be directed to a full treatment system, as specified in Chapter 4 of this Design Manual.

Given the design methodology in this chapter, green infrastructure approaches are effective means for reducing the WQv at sites in phosphorus restricted watersheds. Green infrastructure planning and design approaches can successfully mimic the preconstruction water balance by preserving existing water table elevations and maintaining the watershed hydrologic patterns, base flow of streams and wetlands and the evapotranspiration rates. Ultimately, reductions in post-development runoff are critical in order to minimize phosphorus loading to receiving waters. Section 10.3.5 discusses appropriate source-control approaches.

Goal 2. *Effective Bypass Treatment*

Practices should achieve less than 15% effective treatment bypass of the long term runoff volume. This goal is achieved by capture and treatment of runoff from the 1-year 24-hour storm. Based on this sizing, it is expected that the SMP will not effectively bypass more than 15% of the runoff from the site.

Goal 3. *Achieving Effluent Concentration for Particulate Phosphorus*

For flows that are treated by the system (i.e., flows that are not effectively bypassed), median concentration of particulate phosphorus shall be at or below 0.1mg/L. This effluent concentration of particulate phosphorus is equivalent to a net removal of particulate phosphorus of 80%, given a median influent concentration of 0.5mg/L.

This goal is achieved by designing in accordance with Section 10.4. In the case of storage systems, practices are designed to allow particles to settle out. These storage systems are governed by the depth of the water column and the duration during which the water remains in the basin. In this chapter, a minimum depth of 3 feet (above accumulated sediment) in the permanent pool is specified to allow for adequate detention of water in the pond for the particles to settle out. Depths of standing water should not exceed 8 feet. This provides enough water and oxygen under the ice in the winter while deeper water can have significant stratification issues and inadequate water exchange with deeper water in summer. Note that a minimum depth of 4-6 feet is required in pretreatment and 4 feet is required in the

New York State Stormwater Management Design Manual

Chapter 10: Enhanced Phosphorus Removal Supplement

Section 10.3 Stormwater Sizing Criteria

micropool at the outlet. For the enhanced phosphorus removal, the permanent pool is required to hold at least 50% (100% for wet ponds) of the WQ_v . A minimum length-to-width ratio of 2:1 maximizes the flow path for which particles can settle out and minimizes scour of previously settled particulates. Complete performance criteria for all SMPs designed for enhanced phosphorus removal can be found in Section 10.4.

Stormwater wetlands can also be used to achieve these target concentrations. New design standards for the stormwater wetlands require that in deepwater zones (water depths of greater than 4 feet), 25% of the WQ_v must be met. The minimum depth allows sufficient time for particles to settle out.

Goal 4. Achieving Effluent Concentration for Dissolved Phosphorus

For flows that are treated by the system (i.e., flows that are not effectively bypassed), the median concentration of dissolved phosphorus shall be at or below 0.06mg/L. This effluent concentration of dissolved phosphorus is equivalent to a net removal of dissolved phosphorus of 60%, given a median influent concentration of 0.15 mg/L.

This goal is achieved by designing in accordance with Section 10.4. An acceptable concentration of dissolved phosphorus can be achieved by using systems that result in intimate contact between water and soils, engineered substrates or filtration media such that sufficient opportunity is provided for dissolved phosphorus to sorb to the appropriate substrates or media surfaces. Availability of iron, aluminum or hydrated Portland cement in soil or filtering media can accelerate surface complexation or precipitation, which results in separation of phosphorus species. Furthermore, by increasing and/or optimizing, as well as properly maintaining, vegetation in treatment trains, dissolved phosphorus concentration goals can be met. Systems which incorporate these features can effectively provide physical, chemical and/or biological treatment. Regular maintenance on these systems will allow the vegetation to have optimal living conditions and maintain flow rates. Proper maintenance of vegetation is important for preventing decaying matter from potentially contributing to phosphorus export from treatment systems.

10.3.5 Source Control Options

Hydrologic Source Controls

Hydrologic source control is best achieved through the reduction of the effective impervious surface area of the catchment and minimization of disturbed area. This is particularly the case where pre-

New York State Stormwater Management Design Manual

Chapter 10: Enhanced Phosphorus Removal Supplement

Section 10.3 Stormwater Sizing Criteria

development soils demonstrate significant infiltration capacity. In addition, integrating a series of green infrastructure principles and practices uses micro management of runoff, allows groundwater recharge, increases losses through evapotranspiration and emulates the preconstruction hydrology, resulting in reduced water-quality-treatment volume.

This goal can be accomplished by following green infrastructure principles, as identified in Chapters 3 and 5. The green infrastructure principles are categorized in three major groups: Preservation of Natural Resources, Reduction of Impervious Cover, and green infrastructure techniques. From the hydrologic design standpoint, the first two categories result in reduction of curve numbers, increased flow path and time of concentration. This approach results in reduction of flow volume and peak discharge rate. The third category, however, provides an opportunity for distributed runoff control from individual sources, flow routing, infiltration, treatment and reduction of total water quality volume.

Possible approaches and techniques that may result in reduction of curve number and extension of time of concentration include:

- Minimizing disturbance to keep the ground cover in natural condition, preservation of vegetation, and maximizing evapotranspiration
- Disconnecting directly connected imperviousness
- Employing construction and development practices that minimize grading and compaction of soils (e.g., use of low-pressure or light grading equipment in future pervious areas)
- Employing methods to improve the soil hydrologic function, such as decompaction or soil amendments, to help maintain the natural hydrologic function of the site
- Using site-planning techniques that minimize disturbance and minimize siting of impervious cover on soils with high infiltration rates
- Maintaining the predevelopment time of concentration by methods such as increasing flow path, dispersing flow through natural drainage patterns reforestation, and flattening slopes (given does not occur on existing slopes that would not otherwise be disturbed);
- Increasing roughness by establishing vegetative or woody surfaces that result in increased time of concentration, filtration, pollutant uptake and retard velocity
- Using grass swales instead of closed channels (pipes) to increase infiltration, pollutant uptake and time of concentration

New York State Stormwater Management Design Manual

Chapter 10: Enhanced Phosphorus Removal Supplement

Section 10.3 Stormwater Sizing Criteria

- Using vegetative filter and buffer strips to improve water quality, preserve riparian ecosystem, keep structures out of floodplain, increase times of concentration and reduce curve number
- Reducing curb and gutter to direct the flow onto vegetated or infiltration areas and reduce piped discharge

Practices by which a volumetric reduction may be achieved include:

- Using alternate materials such as porous pavements and paver systems in place of impervious surfaces
- Capturing runoff within the catchment using distributed systems such as soil-amended areas, rain gardens or infiltration, while maximizing evapotranspiration
- Maintaining predevelopment runoff volume through distributed on-site stormwater management by selecting appropriate techniques that mimic the hydrologic functions of the predevelopment condition, micro management of hydrology and siting retention on individual lots
- Providing retention and on-site reuse of runoff. For a listing of techniques refer to Chapter 5 of this Manual.

Please note:

- Acceptable green infrastructure techniques are described fully in Chapter 5, along with sample sizing calculations for each technique
- Reduction of water quality volume by routing the runoff through the above volumetric-reduction practices at maximum will result in a reduction equivalent to the storage volume of the practice.
- No infiltration for larger events may be assumed through source-control practices.

Pollutant Source Controls, Maintenance and Land Management

The available surface-runoff-characterization data indicate that high concentrations of phosphorus in urban and suburban areas tend to be associated with landscaped areas (e.g., residential and commercial lawns, golf courses). Prevention of soil losses via effective stabilization of disturbed areas, maintenance of healthy ground cover and design of landscapes to minimize concentrated flow and maximize time of concentration, as well as controls on application of phosphate-based fertilizers, are primary methods for reducing the export of phosphorus.

References/Further Resources

New York State Stormwater Management Design Manual

Chapter 10: Enhanced Phosphorus Removal Supplement

Section 10.3 Stormwater Sizing Criteria

Center for Watershed Protection. 1998. *Better Site Design: A Handbook for Changing Development Rules in Your Community*. Available from www.cwp.org

New York State Better Site Design Handbook, 2005. New York State Department of Environmental Conservation. (<ftp://ftp.dec.state.ny.us/dow/stormdocuments/designguidance/BSD.pdf>)

New York State Stormwater Management Design Manual, 2003. Chapter 9 (Jan. 2007). (<http://www.dec.state.ny.us/chemical/29072.html> (p 9-1, 9-43))

Prince George's County, MD. June 1999. *Low-Impact Development Design Strategies: An Integrated Design Approach*. Prince George's County, Maryland, Department of Environmental Resources, Largo, Maryland Available from www.epa.gov

New York State Stormwater Management Design Manual

Chapter 10: Enhanced Phosphorus Removal Supplement

Section 10.4: Performance Criteria

10.3.6 Redevelopment Projects

Generally all the requirements for redevelopment projects, as presented in Chapter 9 of this Manual, are applied in the phosphorus-limited watersheds. The overriding factors in application of redevelopment criteria to such projects in the phosphorus-limited watersheds are the design-storm and practice selection. As an example, a redevelopment project in a phosphorus-limited watershed may provide treatment by selection of one of the practices listed in Section 10-4 of this Manual-sized to 25% of water quality volume based on the 1-year 24-hour storm event by the use of practices listed in Chapter 10. Use of alternative practice for treatment of 75% of water quality volume is also acceptable.

Section 10.4: Performance Criteria

Introduction

This section outlines the performance, sizing and design criteria for enhanced phosphorus removal for five groups of structural stormwater management practices (SMPs) to meet the treatment performance goals stated in this chapter. These five groups include stormwater ponds, stormwater wetlands, infiltration practices, filters and open channels.

Evidence suggests that storage systems can increase stream temperature. The use of stormwater ponds and wetlands with 24-hour detention time discharging to trout waters is strongly discouraged unless a second practice is used at the outlet of the pond to cool the effluent before it leaves the site. In the case of storage systems additional mechanisms such as rock radiator or cold water-release design can help reduce the outflow temperature. Sand filters are practices that have also proven to be effective for reduction of temperature.

Maintenance provisions must be developed to ensure the longevity and performance of all permanent stormwater management practices and associated conveyances.

How to Use This Section

This section will note the additional requirements for enhanced phosphorus treatment and how the new design criteria can be met. All criteria defined in this section shall be used as a supplement to the required elements and design guidance provided in chapter 6 of this Manual. This section does not repeat all the design criteria from chapter 6. Instead, this section supersedes the less conservative design criteria defined in chapter 6.

New York State Stormwater Management Design Manual

Chapter 10: Enhanced Phosphorus Removal Supplement

Section 10.4: Performance Criteria

All the pond-design details not specified in this section shall, at minimum, meet the required elements and design guidance as stated in Chapter 6 of this manual.

10.4.1 Stormwater Ponds

Pond-design variants include four options:

- P-1 Micropool Extended Detention Pond (Figure 6.1)
- P-2 Wet Pond (Figure 6.2)
- P-3 Wet Extended Detention Pond (Figure 6.3)
- P-4 Multiple Pond System (Figure 6.4)

Treatment Suitability:

Pocket ponds are not acceptable options for effective phosphorus removal. In the presence of a high-water table, ground water intercept may be incorporated based on a flow-balance analysis on a case-by-case basis.

10.4.1.1. Feasibility

Required Elements

- Stormwater ponds will operate as online treatment systems.
- Location of pond designs within the surface waters of New York is not allowed.

10.4.1.2. Inlet Protection

Required Elements

- A forebay shall be provided at each pond inflow point. In the case of multiple inflow points, alternative pretreatment may replace a forebay at secondary inlets with less than 10% of the total design storm flow rate.
- The forebay depth shall be 4-ft. to 6-ft. deep.

10.4.1.3. Treatment

Required Elements

New York State Stormwater Management Design Manual

Chapter 10: Enhanced Phosphorus Removal Supplement

Section 10.4: Performance Criteria

- Provide water quality treatment storage volume equivalent to the WQ_v , estimated to be the post construction 1-year, 24-hour runoff volume from the contributing area of the development.
- Although both CP_v and WQ_v storage can be provided in the same practice, providing Cp_v storage for the one-year storm can only be met in the wet ED design. In the design of wet ponds, additional storage is required to address channel protection criterion.

10.4.1.4. Minimum Pond Geometry

Required Elements

- The minimum length-to-width ratio for the pond is 2:1 (i.e., length relative to width).
- Minimum permanent pool depth shall be at least 3 feet above sediment storage. Sacrificial storage (an additional 1-2 feet depth) must be incorporated, depending on the pond maintenance plan.
- Maximum permanent pool depth is 8 feet due to the risk of anaerobic condition and phosphorus export.
- Minimum surface-area-to-drainage area ratio of 1:100 or 3% for all connected completely paved areas.
- Include 1-foot freeboard.

10.4.1.5. Landscaping

Required Elements

- Optimize the vegetation in pond for phosphorus uptake.
- Use native plants whenever possible. Natives are typically better suited to the local climate and are easier to establish than exotics. Natives also provide the highest benefit to the local ecosystem. Exotic species can also be considered based upon local guidance and desired attributes. Local conservation groups may provide recommendations on plant species suitable for the region, including natives. Vegetation should also be selected so as not to attract nuisance species.
- Avoid woody vegetation within 15 feet of the toe of the embankment, or 25 feet from the principal spillway.
- The safety bench and pond edges shall be heavily planted with vegetation and barrier riparian cover.
- Design landscaping in drainage area to minimize the use of fertilizer application, which is directly related to phosphorus concentrations.

New York State Stormwater Management Design Manual

Chapter 10: Enhanced Phosphorus Removal Supplement

Section 10.4: Performance Criteria

Tables 10.4 and 10.5 provide useful information on the characteristics of vegetation for stormwater treatment and design consideration for vegetative systems. These elements are key components in helping to achieve optimal phosphorus uptake and short-and long- term performance.

Table 10.4 Useful Characteristics of Vegetation used for Stormwater Treatment*
Tolerant of site-specific and climatic conditions (temperature ranges, averages; total precipitation and duration of precipitation events and inundation, flow velocities, and humidity)
Not invasive or noxious
Tolerant of typical stormwater pollutant concentrations. Evaluating plants used in constructed wetlands for wastewater treatment (as well as established stormwater treatment systems) provides information about pollutant tolerance.
Can uptake, store or otherwise remove pollutants.
Easy to establish and resilient to stress.
Low maintenance requirements (e.g., disease resistant, low fertilization and mowing) Note, high growth rates may increase maintenance requirements.
Adequate growth rates, large surface area of roots, stems and leaves and deep rooted.
Salt-tolerant in areas with high concentrations of soluble salts (arid regions) or cold climates where deicing agents are used.
Aesthetically pleasing (e.g., attracts birds, provides visual interest).
Supports symbiotic associations with microbes (e.g., mycorrhizal fungi or rhizobacteria)
Plants are readily available.

* Table 5-23 from WERF Critical Assessment of Stormwater Treatment and Control Selection Issues (2005)

New York State Stormwater Management Design Manual

Chapter 10: Enhanced Phosphorus Removal Supplement

Section 10.4: Performance Criteria

Table 10.5 General Design Consideration for Vegetated Systems*
Preserve existing natural vegetation whenever possible
Diversify plant species to improve wildlife habitat and minimize ecological succession.
Situate plants to allow access for structure maintenance.
Avoid plants with deep taproots where appropriate, as they may compromise the integrity of filter fabric and earth-dam or subsurface drainage facilities. Note, many native plants may have taproot systems.
Avoid plants that may overpopulate or become too dense-such as that vector issues arise (e.g., vegetation too dense for mosquito fish etc.).
Use seed mixes with fast germination rates under local conditions. Plant vegetation and seeds at appropriate times of the year.
Temporarily divert flows from seeded areas until vegetation is established.
Stabilize water outflows with plants that can withstand storm-current flows.
Shade inflow and outflow channels and southern exposures of ponds to reduce thermal warming.
Plant stream and water buffers with trees, shrubs, bunch grasses and herbaceous vegetation when possible to stabilize banks and provide shade.

* Table 5-24 from WERF Critical Assessment of Stormwater Treatment and Control Selection Issues (2005)

10.4.1.6. Maintenance

Required Elements

- Maintenance responsibility for a pond and its buffer shall be vested with a responsible authority by means of a legally binding and enforceable instrument that is executed as a condition of plan approval.
- Sediment removal in the forebay shall occur every 3 years or after 30% of total forebay capacity has been lost.
- Sediment removal from the main basin every 5 years or when the minimum water depth approaches 3 feet. More regular maintenance will help ensure that the system is achieving the highest removal of phosphorus.

10.4.2 Stormwater Wetlands

New York State Stormwater Management Design Manual

Chapter 10: Enhanced Phosphorus Removal Supplement

Section 10.4: Performance Criteria

Stormwater wetlands shall meet all required elements and design guidance of stormwater ponds as required in this chapter, in addition to the following modifications. All the wetland design details not specified in this section shall, at minimum, meet the required elements and design guidance stated in Chapter 6 of this manual.

Design variants acceptable for enhanced phosphorus removal include:

- W-1 Shallow Wetland (Figure 6.7)
- W-2 ED Shallow Wetland (Figure 6.8)
- W-3 Pond/Wetland System (Figure 6.9)
- W-4 Pocket Wetland (Figure 6.10)

10.4.2.1. Landscaping

Pocket wetlands are the only acceptable options for treatment in the presence of a high water table. The groundwater intercept may be incorporated based on identification of the water table with a contribution less than the total volume of the permanent pool in small sites.

Optimize vegetation for phosphorus uptake. Native plants should be used whenever possible. Natives are typically better suited to the local climate and are easier to establish than exotics. Natives also provide the highest benefit to the local ecosystem. Exotic species can also be considered, based upon local guidance and desired attributes. Local conservation groups may provide recommendations on plant species suitable for the region, including natives. See Table 10.4 and Table 10.5.

- Donor plant material must not be from natural wetlands.

10.4.2.2. Maintenance

Required Element

- Maintenance responsibility for a pond and its buffer shall be vested with a responsible authority by means of a legally binding and enforceable instrument that is executed as a condition of plan approval

10.4.3 Stormwater Infiltration

All the infiltration design details not specified in this section shall, at minimum, meet the required elements and design guidance as stated in Chapter 6 of this Manual.

New York State Stormwater Management Design Manual

Chapter 10: Enhanced Phosphorus Removal Supplement

Section 10.4: Performance Criteria

Stormwater infiltration practices capture and temporarily store the WQ_v before allowing it to infiltrate into the naturally permeable soil during a two-day period. Infiltration systems are good candidates for residential and other urban settings where elevated runoff volumes, pollutant loads, runoff temperatures and particulate and soluble phosphorus are a concern. By infiltration through underlying soil, chemical, biological, sorption and physical processes remove pollutants and delay peak stormwater flows. The design variations for stormwater infiltration systems include the following:

- I-1 Infiltration Trench (Figure 6.11)
- I-2 Infiltration Basin (Figure 6.12)
- I-3 Dry Well (Figure 6.13)
- I-4 Underground Infiltration Systems (Figure 10.1)

Treatment Suitability:

Infiltration practices sized for enhanced phosphorus removal automatically meet channel protection (CP_v) requirements. Infiltration practices alone typically cannot meet detention (Q_p), except on sites where the soil infiltration rate is greater than 5.0 in/hr. However, extended detention storage may be provided above an infiltration basin.

New York State Stormwater Management Design Manual

Chapter 10: Enhanced Phosphorus Removal Supplement

Section 10.4: Performance Criteria

Figure 10.2 A generic display of underground infiltration systems (adapted from MN Stormwater Manual)

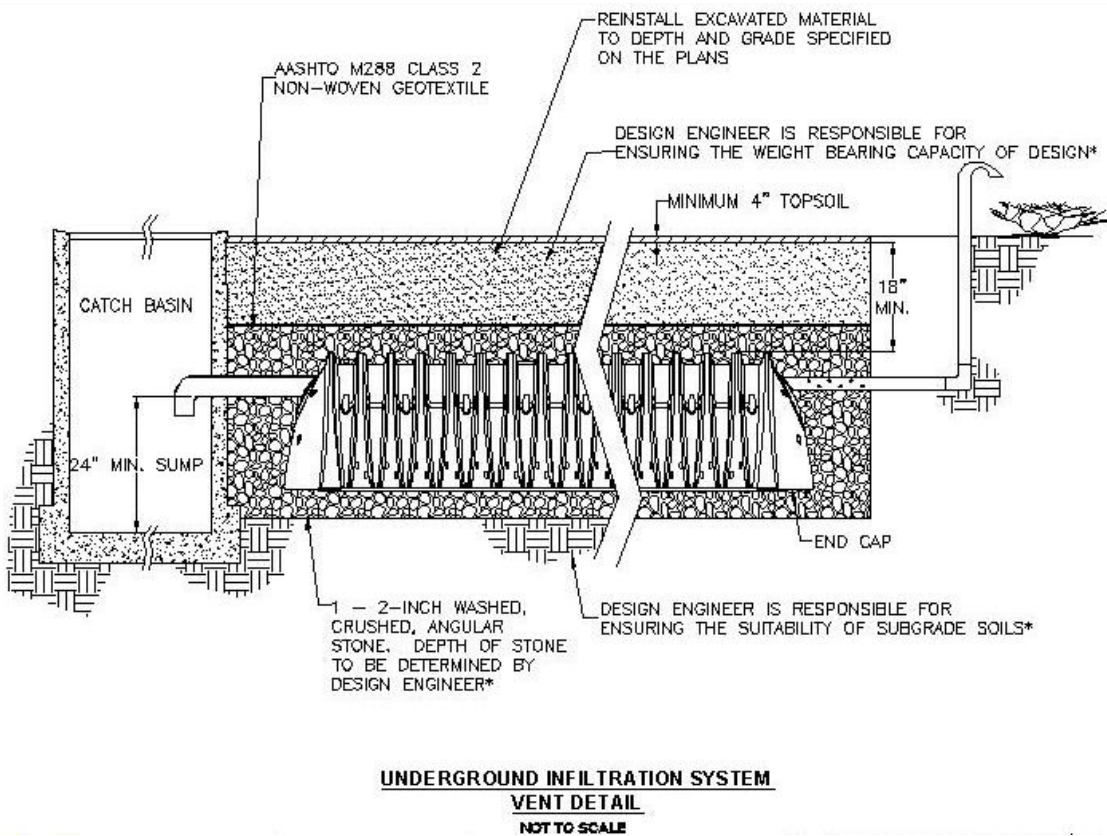
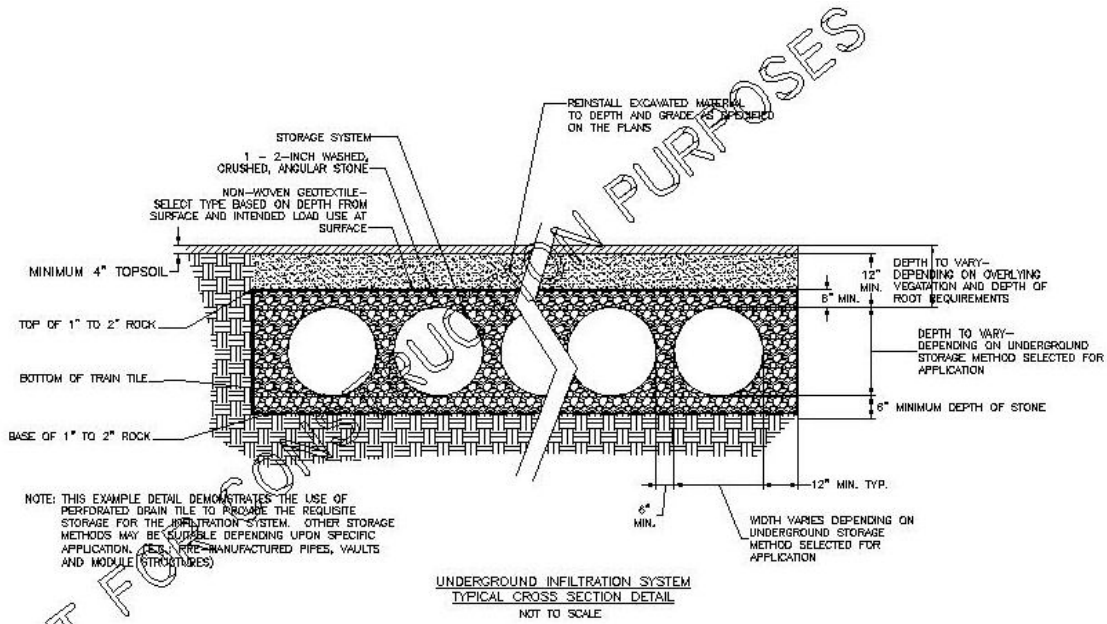

New York State Stormwater Management Design Manual

Chapter 10: Enhanced Phosphorus Removal Supplement

Section 10.4: Performance Criteria

10.4.3.1. Feasibility

- Vertical and horizontal separation distances and setbacks are required from structures such as drinking water supplies, septic systems, foundations and pavements. The intent is for protection of human health, functional and structural integrity, prevention of seepage and frost-heave concerns respectively.

10.4.3.2. Conveyance

- Infiltration systems operate as an offline treatment system with bypass flowing to a stable downstream receptacle unless used as pretreatment to an online system.
- All infiltration systems shall be designed to fully de-water the entire WQ_v within 48 hours after a storm event.
- Exit velocities from pretreatment chambers shall be non erosive (3.5 to 5.0 fps during the two-year design storm) and less than 3 fps during the one-year design storm.

10.4.3.3. Treatment

Required Elements

- Water quality volume (WQ_v) is equivalent to the estimated 1-year, 24-hour post-construction runoff volume.
- Provide diversion for construction runoff and minimize construction traffic over infiltration area.
- Trench depth shall be less than 4 feet (I-2 and I-3). Infiltration basins (I-1) may be 2-to-12- feet deep.

Design Guidance

- Infiltration basin side slopes should be kept to a maximum 1:3 (V:H).
- Infiltration systems are not allowed on fill soil because they lack consistency and structural strength.
- Soil de-compaction is required for recovering infiltration capacity in disturbed areas. Information on de-compaction techniques is provided in a separate guidance document.
- Infiltration is not recommended in active karst formations without adequate geotechnical testing.
- To avoid designs that may conflict with the U.S. Environmental Protection Agency (EPA) Class V injection wells, defined as any bored, drilled or driven shaft or dug hole that is deeper than its widest surface dimension, or an improved sinkhole or a subsurface fluid-distribution system. Consult EPA's fact sheet on this issue for further information:

New York State Stormwater Management Design Manual

Chapter 10: Enhanced Phosphorus Removal Supplement

Section 10.4: Performance Criteria

- http://www.epa.gov/safewater/uic/class5/types_stormwater.html
- <http://yosemite.epa.gov/water/owrccatalog.nsf/1ffc8769fdec48085256ad3006f39fa/87418a822b4ba98985256c9c005cb2bf!OpenDocument>
- Underground Infiltration Systems - Several underground infiltration systems, including pre-manufactured pipes, vaults and modular structures, have been developed as alternatives to infiltration basins and trenches for space-limited sites and stormwater redevelopment applications. These systems are designed similar to infiltration basins or trenches, depending on site specific conditions, to capture, temporarily store and infiltrate the WQv within 48 hours. Underground infiltration systems are generally applicable to small development sites (typically less than 10 acres) and should be installed in areas that are easily accessible to maintenance. These systems should not be located in areas or below structures that cannot be excavated in the event that the system needs to be replaced (MN Design Manual, 2006).

10.4.3.4. Landscaping

Required Elements

- Design landscaping features in drainage area that minimize fertilizer application.
- Limit access of high-impact earth moving equipment, do not over-excavate, and use de-compaction practices to restore the soils original infiltration properties.

Design Guidance

- Infiltration trenches can be covered with permeable topsoil and planted with grass. Use deep-rooted plants such as prairie grass to increase the infiltration capacity of the underlying soils.

10.4.3.5. Maintenance

Required Elements

Maintenance responsibility for an infiltration system shall be vested with a responsible authority by means of a legally binding and enforceable instrument that is executed as a condition of plan approval. Remove sediment/gross solids from the infiltration surface annually, to ensure the maximum surface area for treatment.

- The vegetative cover needs to be regularly maintained. Grass cover may be mowed and bare areas should be reseeded
- Disc, aerate or scrape the basin bottom to restore original cross section and infiltration rate every one to five years.

New York State Stormwater Management Design Manual

Chapter 10: Enhanced Phosphorus Removal Supplement

Section 10.4: Performance Criteria

- To avoid soil compaction concerns, infiltration areas should not be used for recreational purposes unless a soil amendment is used.

10.4.4 Stormwater Filtering Systems

Filtering systems designed with a recharge capacity must also meet the soil testing, separation distance and siting requirements of infiltration systems. Design variants include:

- F-1 Surface Sand Filter (Figure 6.15)
- F-2 Underground Sand Filter (Figure 6.16)
- F-3 Perimeter Sand Filter (Figure 6.17)
- F-4 Organic Filter(peat) (Figure 6.18)
- F-5 Bioretention (Figure 6.19)

Treatment Suitability: Stormwater bioretention areas are shallow stormwater basin or landscaped area which utilizes engineered soils and vegetation to capture and treat runoff. Bioretention practices are often located in parking lot islands, and can also be used to treat runoff in residential areas.

10.4.4.1 Conveyance

Required Elements

- Systems will operate as offline treatment systems with bypass to stable downstream conveyances, unless used as pretreatment to an online system.
- Conveyance to bioretention system is typically overland flow delivered to the surface of the system, usually through curb cuts or over a concrete lip.

10.4.4.2 Pretreatment

Required Elements

- Redundant pretreatment must be provided in areas with clay soils.

10.4.4.3 Treatment

Required Elements

- Water Quality Volume (WQ_v) is equivalent to the estimated 1-year, 24-hour post development runoff volume.

New York State Stormwater Management Design Manual

Chapter 10: Enhanced Phosphorus Removal Supplement

Section 10.4: Performance Criteria

- Filter media vary 1.5-3 feet deep according to the design variation as specified in schematics (Figures 6-15 to 6-19). Filter media shall meet the following requirements:
- Inorganic fraction of filter media shall be ASTM C-33 sand.
- The organic fraction of filter media in F-4 and F-5 shall be a sand/peat mixture.
- Media in F-5 design should contain 5-15% organic matter. Select organic matter that is not a source of phosphorus. Peat is greatly preferred due to low phosphorus and high cation-exchange capacity. Composts are an unacceptable alternative to peat. They are a major source of phosphorus for the first several years of operation (to underdrain water or percolate water to groundwater). When the soils go anaerobic, compost easily loses any phosphorus (and metals) it has accumulated. Peat does not have this risk of leachate.
- The engineered media shall have a low phosphorus index (0-25). (Hunt, 2006)
- Media should contain 0% clay. Any clay greatly hastens failure, especially in the presence of geotextiles.
- A permeable non-woven filter fabric shall be placed between the gravel layer and the filter media.
- In the design of bioretention areas, surface overflows should be used instead of underdrains, where possible. (i.e., where head is available, systems can be designed to drain to surface features instead of sub-surface conveyances as they drain).

10.4.4.4 Landscaping

Required Elements

- Provide a detailed landscaping plan.
- Landscape to minimize the application and frequency of fertilizer in the drainage area.
- Optimize vegetation in the filter for maximum phosphorus uptake.
- Stabilize contributing area before runoff is directed to the facility.
- Provide detailed landscaping plan for bioretention area.
- Optimize vegetation in the bioretention for phosphorus uptake. See Table 10.4 and Table 10.5.

10.4.4.5 Maintenance

Required Elements

New York State Stormwater Management Design Manual

Chapter 10: Enhanced Phosphorus Removal Supplement

Section 10.4: Performance Criteria

Maintenance responsibility for a filtering system shall be vested with a responsible authority by means of a legally binding and enforceable instrument that is executed as a condition of plan approval.

- Remove sediment/gross solids from sedimentation chamber and filter surface annually or when depth exceeds 3 inches.
- Remove sediment/gross solids from bioretention surface annually or when depth exceeds 3 inches.
- Keep the vegetation height limited to 18 inches in bioretention systems to facilitate routine maintenance and allow for observation of system function.
- Rehabilitate/replace mulch and bioretention media (top 6 inches minimum) when flow-through rate is reduced to <60% design treatment flow rate. This is determined by observing ponding in the facility following a storm event.
- Provide stone drop (at least 6 inches) at the inlet.

10.4.4.6 Drainage configuration

Required Elements

- Systems designed for recharge do not require use of underdrain pipe and geotextile fabric on the bottom of the facility. Systems designed for recharge and filtration do not need geotextile fabric on the bottom of facility, but require a gravel underdrain and perforated pipe.
- The areas above the pipe between the made soil and gravel must be covered by a non woven filter fabric.

A liner must be provided between the made soil and the in-situ soils to minimize the risk of groundwater contamination, when treating runoff from hotspot areas. A raised underdrain pipe in the stone reservoir may be incorporated for additional storage for quantity controls.

Section 10.4.5 Stormwater Open Channel Systems

All the open channel system design details, not specified in this section, shall at minimum meet the required elements and design guidance as stated in Chapter 6 of this Manual.

Design variants include:

- O-1 Dry Swale (Figure 6.20)

10.4.5.1. Feasibility

New York State Stormwater Management Design Manual

Chapter 10: Enhanced Phosphorus Removal Supplement

Section 10.4: Performance Criteria

Open channels are not effective stand alone practices for enhanced removal of phosphorus due to their limited ability to provide 24-hour detention and trap smaller particulates under most conditions. They may be effective only during low flows with a shallow water depth.

Open channels have been found to be effective for the purposes of reducing runoff through infiltration and affecting runoff hydrology (i.e., reducing peak discharges), which can be a key component of site hydraulic source control. An open channel design is provided in this supplement only for application in linear projects redevelopment projects, or in combination with other practices.

10.4.5.2. Treatment

Required Elements

- The geometry of the design must be linear with limited ponding depth less than 3 times the height of the grass.
- Temporarily store the WQv within the facility during a minimum 30-minute period. Computation of travel time may be used to document meeting this requirement.
- Soil media for the dry swale shall meet the specifications of bioretention media specified in this section of the Manual.

10.4.5.3. Maintenance

Required Elements

- Maintenance responsibility for an open channel shall be vested with a responsible authority by means of a legally binding and enforceable instrument that is executed as a condition of plan approval

Section 10.5 Design Examples

10.5.1 Introduction

This section presents design examples for two hypothetical development sites in the State of New York. The first site, “Stone Hill Estates,” is a pond design in a residential development and the second example is a filter design in a commercial site. Both sites are located in the New York City watershed (east-of-Hudson). Both examples incorporate several design features of the BSD principles and hydrologic source control.

Example 1 presents a pond design example similar to the hydrology calculated in Section 8.1 of this Manual (note the change in geographic location). This design example demonstrates the hydrologic and hydraulic computations to achieve water quality and, to a limited extent, water quantity control for stormwater management. Other specific dam design criteria such as soil compaction, structural appurtenances, embankment drainage, outlet design, gates, reservoir drawdown requirements, etc. are not included in the example, but are stated in Guidelines for Design of Dams; Appendix A of this Manual.

Example 1 requires an Article 15 Dam Permit from NYS-DEC since the dam is 15 feet high measured from the top of dam to the toe of slope at the downstream outlet, and the storage measured behind the structure to the top of the dam is 2.2 MG.

Design Example 1 is completed for both a Wet Pond (P2) and a Wet Extended Detention (P3) Pond. Both are designed based on the criteria for enhanced phosphorus removal discussed in this chapter.

Example 2 demonstrates water quality design calculations for a sand filter for a commercial site. Only calculations for water quality volume (WQ_v) and channel protection volume (Cp_v) are included because the design of flood controls and ultimate build-out conditions follow the same steps as sections 8.1 and 8.2 of this manual. Both examples present new developments, whose design is based on BSD principles and focuses on hydrologic source control. These scenarios demonstrate how hydrologic source control is best achieved through reduction of the effective impervious surface and minimization of disturbed area.

All other design calculation methodologies remain consistent with the Design Manual and can be found in Chapter 8 of this manual.

New York State Stormwater Management Design Manual

Chapter 10: Enhanced Phosphorus Removal Supplement

Section 10.5 Design Examples

10.5.2 Hydrology Sizing Method – Stone Hill Estates

See Chapter 8, Section 8.1 for the complete site information and figures. The following shows only the elements of the design prepared in accordance with the enhanced phosphorus removal sizing criteria.

As illustrated in Figure 8.1 of Section 8.1, “Stone Hill Estates” is a 45-acre residential development with 20 acres of off-site drainage, which is currently in a meadow condition. The site is on mostly C soils with some D soils.

Base Data

Location: New York City Watershed (East of Hudson)

Site Area = 45.1 acres; Offsite Area = 20.0 ac (meadow)

Total Drainage Area (A) = 65.1 ac

Measured Impervious Area = 12.0 ac

Site Soil Types: 78% “C”, 22% “D”

Offsite Soil Type: 100% “C”

Zoning: Residential (½ acre lots)

1-yr 24-hr storm = 2.8 inches

Hydrologic Data

	Pre	Post	Ult.
CN	72	78	82
t_c (hr)	.44	.33	.33

The computations in Section 8.1 begin by 1) calculating the water Quality volume (WQ_v) for the site, and 2) establishing the hydrologic input parameters and developing the site hydrology. The WQ_v

New York State Stormwater Management Design Manual

Chapter 10: Enhanced Phosphorus Removal Supplement

Section 10.5 Design Examples

required for enhanced phosphorus removal cannot be calculated until the latter of the two steps have been completed because it is dependent on these values.

Step 1. Establish Hydrologic Input Parameters and Develop Site Hydrology (see Tables 10.5.1 and 10.5.2)

Table 10.5.1 Hydrologic Input Parameters

	Area (ac)	CN	Tc (hr)
Pre-developed	65.1	72	0.44
Post-developed	65.1	78	0.33
Ultimate buildout*	65.1	82	0.33

*Zoned land use in the drainage area.

Table 10.5.2 Hydrologic Calculations

Condition	V_{1-yr} in	Q_{1-yr} cfs	Q_{10-yr} cfs	Q_{100-yr} cfs
Pre-developed	0.62	28	99	207
Post-developed	0.99	49	139	266
Ultimate buildout	NA	NA	NA	411

The rainfall for 1-year 24-hour storm is 2.8 inches. The time of concentration is dependent on the 2-year rainfall event, which is 3.5 inches in this location. (Figure 4.7 in Chapter 4 illustrates the 2-year, 24-hour rainfall map for New York). In addition, the site is located in the Type III rainfall map.

Step 2. Compute Water Quality Volume, (WQ_v)

Compute WQ_v for Enhanced Phosphorus Removal

WQ_v = Estimated runoff volume (acre-feet) resulting from the 1-year, 24-hour design storm over the post development watershed (includes contributing on-site and off-site drainage from impervious and pervious areas alike)

New York State Stormwater Management Design Manual

Chapter 10: Enhanced Phosphorus Removal Supplement

Section 10.5 Design Examples

The hydrologic calculations show that the 1-year, 24-hour event results in 0.99 inches of runoff over the total contributing site area. Therefore, the WQ_v can be calculated as follows:

$$\begin{aligned} &= (\text{Total Drainage Area})(V_{1\text{-yr}}) \\ &= (65.1 \text{ ac})(0.99 \text{ in})(1 \text{ ft}/12\text{in}) \\ &= 5.37 \text{ ac-ft} \end{aligned}$$

In final stabilization of the site, soil-decompaction practices are applied to all disturbed area. Because of soil restoration practice, hydrologic soil group curve numbers applied to the grass areas are kept as those of pre-construction condition.

New York State Stormwater Management Design Manual

Chapter 10: Enhanced Phosphorus Removal Supplement

Section 10.5 Design Examples

Table 10.5.3 Stone Hill Pre-Development Conditions

PEAK DISCHARGE SUMMARY				
JOB: STONE HILL		SK		
DRAINAGE AREA NAME: PRE DEVELOPMENT		10/07/07		
COVER DESCRIPTION	SOIL NAME	GROUP A,B,C,D	Curve Number	AREA (In acres)
MEADOW		C	71	20.25 Ac.
MEADOW		D	78	7.95 Ac.
WOOD		C	70	15.09 Ac.
WOOD		D	77	1.81 Ac.
OFF-SITE MEADOW		C	71	20.00 Ac.
			AREA SUBTOTALS:	65.10 Ac.
Time of Concentration	Surface Cover	Manning 'n'	Flow Length	Slope
2-Yr 24 Hr Rainfall = 3.5 In	Cross Section	Wetted Per	Avg Velocity	Tt (Hrs)
Sheet Flow	dense grass	'n'=0.24	150 Ft.	3.80%
				0.26 Hrs
Shallow Flow	UNPAVED		1300 Ft. 2.65 F.P.S.	2.70%
				0.14 Hrs.
Channel Flow		'n'=0.040	1100 Ft.	2.70%
Hydraulic Radius =1.26	22.0 SqFt	17.5 Ft.	7.14 F.P.S.	0.04 Hrs.
Total Area in Acres =	65.10 Ac.	Total Sheet Flow=	Total Shallow Flow=	Total Channel Flow =
Weighted CN =	72	0.26 Hrs.	0.14 Hrs.	0.04 Hrs.
Time Of Concentration =	0.44 Hrs.	RAINFALL TYPE III		
Pond Factor =	1			
	<i>Precipitation (P) inches</i>	<i>Runoff (V)in</i>	<i>Qp, PEAK DISCHARGE</i>	<i>TOTAL STORM Volumes</i>
STORM				
1 Year	2.8 In.	0.69	28 CFS	162,217 Cu. Ft.
2 Year	3.5 In.	1.11	48 CFS	263,102 Cu. Ft.
10 Year	5.0 In.	2.19	99 CFS	516,360 Cu. Ft.
100 Year	7.8 In.	4.5	207 CFS	191,446 Cu. Ft.

New York State Stormwater Management Design Manual

Chapter 10: Enhanced Phosphorus Removal Supplement

Section 10.5 Design Examples

Table 10.5.4 Stone Hill Post-Development Conditions

PEAK DISCHARGE SUMMARY				
JOB: STONE HILL				SK
DRAINAGE AREA NAME: POST DEVELOPMENT				10/07/07
COVER DESCRIPTION	SOIL NAME	GROUP A,B,C,D	Curve Number	AREA (In acres)
MEADOW		C	71	0.16 Ac.
MEADOW		D	78	0.14 Ac.
WOOD		C	70	3.09 Ac.
WOOD		D	77	1.81 Ac.
IMPERVIOUS			98	12.00 Ac.
GRASS		C	74	20.09 Ac.
GRASS		D	80	7.81 Ac.
OFFSITE MEADOW		C	71	20.00 Ac.
			AREA SUBTOTALS:	65.10 Ac.
Time of Concentration	Surface Cover	Manning 'n'	Flow Length	Slope
2-Yr 24 Hr Rainfall = 3.5 In	Cross Section	Wetted Per	Avg Velocity	Tt (Hrs)
Sheet Flow	dense grass	'n'=0.24	100 Ft.	3.80%
				0.19 Hrs
Shallow Flow (a)	UNPAVED		100 Ft.	1.50%
			1.98 F.P.S.	0.01 Hrs.
(b)	PAVED		400 Ft.	1.00%
			2.03 F.P.S.	0.055 Hrs.
Channel Flow (a)		'n'=0.013	1550 Ft.	1.00%
Hydraulic Radius =0.50	1.6 SqFt	3.2 Ft.	7.22 F.P.S.	0.06 Hrs.
(b)		'n'=0.030	350 Ft.	4.30%
Hydraulic Radius =1.42	12.0 SqFt	8.5 Ft.	13.01 F.P.S.	0.01 Hrs.
(c)		'n'=0.040	300 Ft.	3.30%
Hydraulic Radius =1.26	22.0 SqFt	8.5 Ft.	7.89 F.P.S.	0.01 Hrs.
Total Area in Acres =	65.10 Ac.	Total Sheet	Total Shallow	Total Channel
Weighted CN =	78	Flow=	Flow=	Flow =
Time Of Concentration =	0.34 Hrs.	0.19 Hrs.	0.07 Hrs.	0.08 Hrs.
Pond Factor =	1	RAINFALL TYPE III		
STORM	Precipitation (P) inches	Runoff (V)in	Qp, PEAK DISCHARGE	TOTAL STORM Volumes
1 Year	2.8 In.	0.99 In.	49 CFS	233,950 Cu. Ft.
2 Year	3.5 In.	1.49 In.	75 CFS	352,313 Cu. Ft.
10 Year	5.0 In.	2.7 In.	139 CFS	638,328 Cu. Ft.
100 Year	7.8 In.	5.19 In.	266 CFS	1,226,170 Cu.Ft

Step 3. Evaluate Source Control and Compute Flow Reduction

The conventional design (not incorporating BSD) WQ_v of 5.37 ac-ft results from a site design that includes 45 acres of disturbed area. A detention pond would need to be designed to treat the WQ_v on-site. The area required for this practice has a footprint of around 0.7 acres for treatment of runoff from 108 houses and roads.

To reduce the flow by source control, two Better Site Design (BSD) features are selected to be incorporated in the site plan: vegetated buffers and rain gardens.

1. *Vegetated Buffers – Incorporating this feature would preserve about 4 acres of undisturbed natural area that in a conventional design would have been planned to be seeded as lawn areas. Instead, the area is preserved as forested conservation areas. This practice is applied in both soil types C and D and helps reduce the Curve Number from 78 to 77.*

Figure 10.5.1 Conventional versus BSD

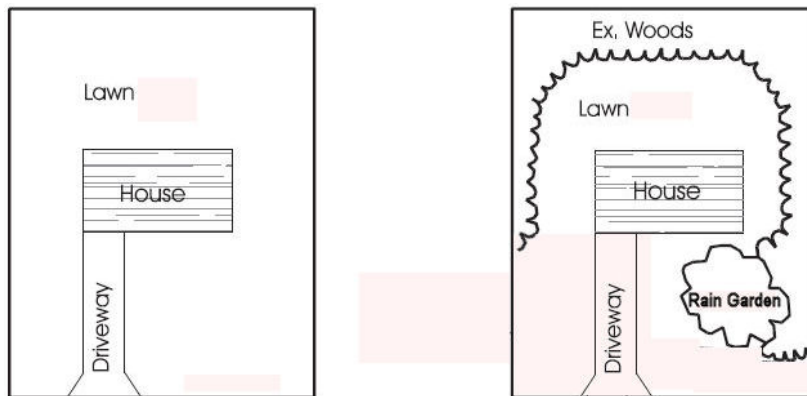

2. *Rain Gardens – In this example, rain gardens are designed to receive runoff from a section of the rooftop on about half of the lots. Rain gardens are not intended to provide treatment for the entire water quality volume of the drainage area. Routing of the flow through rain gardens results in reduction of the WQ_v based upon the storage size of the rain garden. This*

practice is applied on the lots with soil type C. A rain garden's maximum allowable impervious area is 1000 ft² (as specified in the rain garden profile sheet in Chapter 9 of this manual), designed to store and filter storm water within the planting media and to exfiltrate a fraction of the 1-year storm to the ground. A bypass also routes excess flow to the pond. An average size of 270 ft² surface area is used for rain gardens which should be located within 30 ft. of the downspouts. The runoff volume to the rain gardens is primarily from driveways, lawns and disconnected rooftops. Roof leaders drain the rooftop runoff to the rain garden via a splash block and over a grass buffer that extends 20 ft. The rooftop runoff from half of the dwelling units (56 rooftops) is routed through rain gardens. Sites are graded so that the runoff volume reaches the rain garden, allowing infiltration of runoff volume equivalent to the storage capacity of the rain garden, while the outlet conveys excess flows of larger storms to the pond.

Storage capacity of rain gardens is calculated based on the following parameters:

Table 10.5.5. Calculate Storage Capacity of Rain Gardens

New York State Stormwater Management Design Manual

Chapter 10: Enhanced Phosphorus Removal Supplement

Section 10.5 Design Examples

WQv		56 units		
Solve for drainage layer and soil media storage volume:				
$V_{SM} = A_{RG} \times D_{SM} \times P_{SM}$				
$V_{DL} = A_{RG} \times D_{DL} \times P_{DL}$				
where:				Units
A_{RG} = proposed rain garden surface area (ft ²)		270		ft ²
D_{SM} = depth soil media = 12 inches (ft)		1		Ft
D_{DL} = depth drainage layer = 6 inches (ft)		0.5		Ft
P_{SM} = porosity of soil media		0.2		
P_{DL} = porosity of drainage layer = 0.40		0.4		
V_{SM} = storage volume in soil media		50		ft ³
V_{DL} = storage volume in drainage layer		50		ft ³
D_P = ponding depth		0.50		Ft
$WQv = V_{SM} + V_{DL} + (D_P \times A_{RG})$		225		ft ³
Number of Units		56		
Reduction in WQv (ft ³)		13,608		ft ³

In modeling the hydrology of the site with source control, adding 56 rain gardens controls runoff from approximately 1.3 acres of roof top and 1.3 acres landscaped area, which results in control and reduction of 0.31 ac-ft of WQv. The runoff volume to the rain gardens is primarily from driveways, lawns and disconnected rooftops. From the runoff generated, 13,600 ft³ (0.31 ac-ft) infiltrates into the native soil and does not reach the height of the rectangular weir outlet structure (1.5ft) designed to safely drain the

New York State Stormwater Management Design Manual

Chapter 10: Enhanced Phosphorus Removal Supplement

Section 10.5 Design Examples

overflow from the rain garden into the conveyance system. Source control results in around 6% reduction of final WQv. Table 10.5.6 provides a summary of source control reduction.

Table 10.5.6 Summary of Meeting Source Control Criterion	
Rooftop with BSD (ft ²)	1000
Number of Roof tops (1/2 of the dwelling units) tributary to rain gardens	56
Total Area (acre)	1.29
Total Imp. Area (acre)	12
% Imp. Area	0.11
Routing of 11% of impervious area through rain gardens meets the source control requirement (10% for HSG C)	

Step 4. Compute Stream Channel Protection Volume, (Cp_v)

The channel protection volume (Cp_v) requirement is achieved by detaining the 1-year, 24-hour storm to achieve a center of mass detention time (CMDT) of at least 24 hours. This can be achieved by adjusting the outlet structure (see Section 4.3 for complete discussion of Channel Protection Volume). In some cases, this will require reducing the extended detention orifice size and adjusting the overflow weir design.

Wet ponds are not designed for detaining flow; therefore, the difference between the inflow and outflow hydrographs is insignificant when sized purely for water quality control. The Cp_v requirement may be provided above the WQ_v in a wet pond (P2) or a stormwater wetland. Therefore, once a pond has been sized to meet the WQ_v requirement, a TR-55 and TR-20 (or approved equivalent) model may be used to determine center of mass detention Time. By modifying the pond volume and the elevation and size of the outlet structure(s), in a trial and error fashion, the Cp_v requirement can be met. Alternatively, the methodologies in Appendix B can be followed to ensure the Cp_v requirement is met. An example of this methodology is shown in Section 8.1 of Chapter 8.

New York State Stormwater Management Design Manual

Chapter 10: Enhanced Phosphorus Removal Supplement

Section 10.5 Design Examples

It may be necessary to install detention ponds or underground vaults onsite to meet the C_{pv} requirement of 24-hour extended detention if pond sizes become too large. Schematics of typical designs are shown in figures 4.2 and 4.3. Note that although these practices meet water quantity goals, they are unacceptable for water quality control because of poor pollutant removal and need to be installed subsequent to a practice in Section 10.2 of this chapter to ensure enhanced phosphorus removal.

Step 5. Additional Sizing Requirements

See Chapter 8, Section 8.1 for example procedures for computation of the Overbank Flood Protection Volume (Q_{p10}), the Extreme Flood Protection Volume (Q_f), and the Safe Passage of 100-Year Design Storm (Q_f).

10.5.3 Pond Design Example – Stone Hill Estates

See Chapter 8, Section 8.2 Pond Design Example for the complete example, figures and calculations. The following shows only the elements of the example that have changed, in respect to this chapter, for enhanced phosphorus removal. The example provides calculations for both a Wet Pond and an Extended Detention Wet Pond.

Step 1. Compute Preliminary Runoff Control Volumes

The volume requirements were determined in Section 10.5.2. Table 10.5.7 provides a summary of the storage requirements.

Table 10.5.7 Summary of General Storage Requirements for Stone Hill Estates			
Symbol	Category	Volume Required (ac- ft)	Notes
WQ_v	Water Quality Volume	5.06	Final WQ_v $5.37 - 0.31 = 5.06 \text{ ft}^3$
C_{pv}	Channel Protection Volume	TBD	Wet Pond: See Below ED Wet Pond: N/A

New York State Stormwater Management Design Manual

Chapter 10: Enhanced Phosphorus Removal Supplement

Section 10.5 Design Examples

Step 2. Determine whether the development site and conditions are appropriate for the use of a stormwater pond.

There are no additional requirements for this site. Procedures are identical to those presented in Chapter 8.

Step 3. Confirm local design criteria and applicability.

There are no additional requirements for this site. Procedures are identical to those presented in Chapter 8.

Step 4. Determine pretreatment volume.

Size wet forebay to treat 10% of the WQ_v . $(10\%)(5.1 \text{ ac-ft}) = \mathbf{0.51 \text{ ac-ft}}$

(Forebay volume is included in WQ_v as part of the permanent pool volume.)

Step 5. Determine permanent pool volume and ED volume.

Size permanent pool volume to contain 50% of WQ_v :

$0.5 \times (5.10 \text{ ac-ft}) = \mathbf{2.55 \text{ ac-ft}}$. (includes 0.51 ac-ft of forebay volume)

Size ED volume to contain 50% of WQ_v : $0.5 \times (5.10 \text{ ac-ft}) = \mathbf{2.55 \text{ ac-ft}}$

Step 6. Determine pond location and preliminary geometry. Conduct pond grading and determine storage available for WQ_v permanent pool and WQ_v -ED (if applicable).

This step involves initially grading the pond (establishing contours) and determining the elevation-storage relationship for the pond. Storage must be provided for the permanent pool (including sediment forebay), extended detention (WQ_v -ED) and the C_p -ED. Calculations for the 10-year, and 100-year storms, plus sufficient additional storage to pass the ultimate condition 100-year storm with required freeboard can be found in Section 8.2 of Chapter 8. An elevation-storage table and curve is prepared using the average area method for computing volumes. See Figure 8.7 in Chapter 8 for pond location on site and Table and 10.5.8 for elevation-storage data and figure 0.10.5.2. for Stage Discharge Curve.

New York State Stormwater Management Design Manual

Chapter 10: Enhanced Phosphorus Removal Supplement

Section 10.5 Design Examples

Table 10.5.8 Storage-Elevation Table

Elevation	Area	Average Area	Depth	Volume	Cumulative Volume	Cumulative Volume	Volume Above Permanent Pool
MSL	ft ²	ft ²	ft	ft ³	ft ³	ac-ft	ac-ft
621.00	13671						
624.00	36130	24901	3.0	74702	74702	1.71	0.00
625.20	45136	40633	1.2	48760	123461	2.83	0.28
627.50	60109	52623	2.3	121032	244493	5.61	2.96
628.00	94829	77469	0.5	38735	283227	6.50	3.85
629.30	114359	104594	1.3	135972	419200	9.62	6.97
632.00	132262	123311	2.7	332938	752138	17.27	14.62
634.00	154324	143293	2.0	286586	1038724	23.85	21.20
635.00	184321	169323	1.0	169323	1208046	27.73	25.08

Figure 10.5.2. Stage Discharge Curve

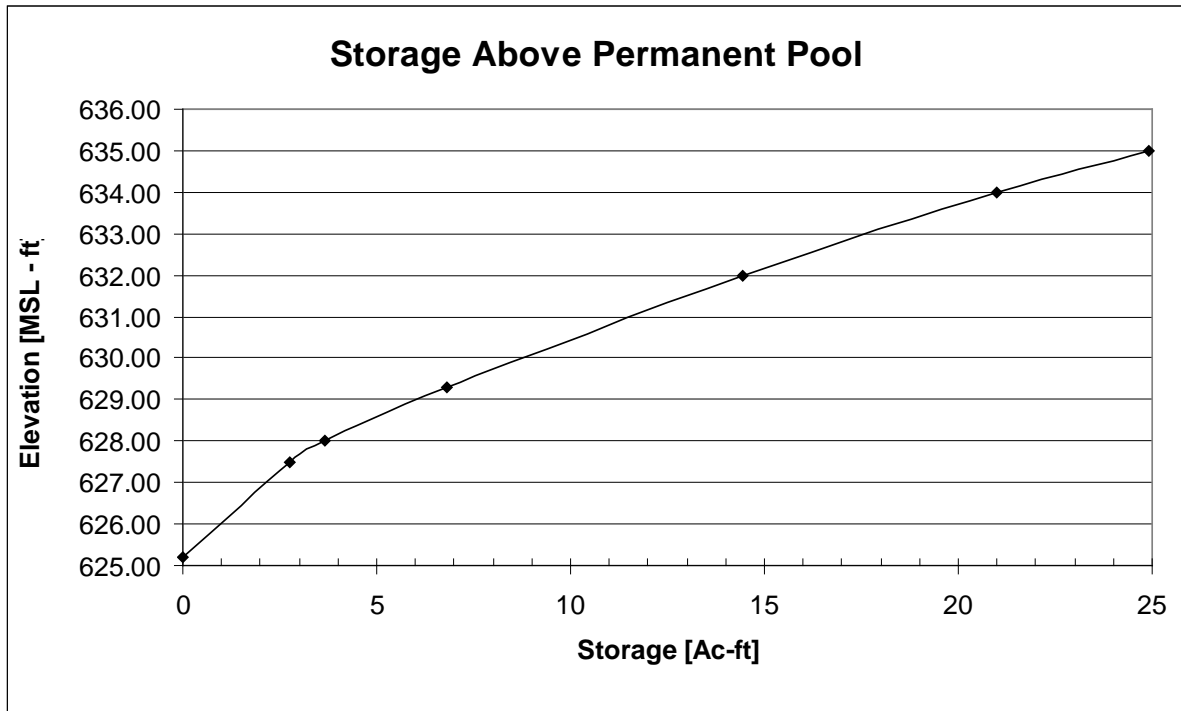

Set basic elevations for pond structures

- Set the pond bottom at elevation 621.0
- Provide gravity flow to allow for pond drain set riser invert at 620.5
- Set barrel outlet elevation at 620.0

Set water surface and other elevations

- Required permanent pool volume = 50% of $WQ_v = 2.55$ ac-ft. From the elevation-storage table, read elevation 625.2 (2.83 ac-ft > 2.55 ac-ft) site can accommodate it and it allows a small safety factor for fine sediment accumulation - OK
- Set permanent pool WSEL = 625.2
- Forebay volume provided in single pool with volume = 0.51 ac-ft – OK
- Add 1 ft to the depth of the forebay to account for sacrificial storage for sediment deposition.
- The pond pretreatment bottom is set at elevation 620.0

New York State Stormwater Management Design Manual

Chapter 10: Enhanced Phosphorus Removal Supplement

Section 10.5 Design Examples

- Required extended detention volume ($WQ_v\text{-ED}$) = 2.55 ac-ft. From the elevation-storage table (volume above permanent pool), read elevation 627.5 (2.78 ac-ft > 2.55 ac-ft) OK. Set ED wsel = 627.5
- Check the pond surface area to drainage area ratio:

Perm. Pool V.	2.55		Surface area at WQ_v (sf)	52622.5
Drainage area (sf)	2835756		Surface area ratio 1:100	0.018557

NOTE: Total storage at elevation 627.5 = 5.61 ac-ft (greater than required WQ_v of 5.1 ac-ft)

Compute the required $WQ_v\text{-ED}$ orifice diameter to release 2.55 ac-ft during 24 hours (for Wet ED Pond Only)

- Avg. ED release rate = $(2.55 \text{ ac-ft})(43,560 \text{ ft}^2/\text{ac}) / (24 \text{ hr})(3600 \text{ sec/hr}) = 1.29 \text{ cfs}$
- Invert of orifice set at wsel = 625.2
- Average head = $(627.5 - 625.2) / 2 = 1.15'$
- Use orifice equation to compute cross-sectional area and diameter
 - $Q = CA(2gh)^{0.5}$, for $Q=1.29 \text{ cfs}$ $h = 1.15 \text{ ft}$; $C = 0.6 =$ discharge coefficient Solve for A
 - $A = 1.29 \text{ cfs} / [(0.6)((2)(32.2 \text{ ft/s}^2)(1.15 \text{ ft}))^{0.5}] A = 0.25 \text{ ft}^2, A = \pi d^2 / 4;$
 - dia. = 0.57 ft = 6.76 inches
 - Use 8" pipe with a gate valve to achieve equivalent diameter.

Compute the stage-discharge equation for the 6.9" dia. $WQ_v\text{-ED}$ orifice.

- $Q_{WQ_v\text{-ED}} = CA(2gh)^{0.5} = (0.6) (0.2 \text{ ft}^2) [((2)(32.2 \text{ ft/s}^2))^{0.5}] (h^{0.5})$
- $Q_{WQ_v\text{-ED}} = (1.25) h^{0.5}$, where: $h = \text{wsel} - 625.65$

(Note: Account for one half of orifice diameter when calculating head.)

NOTE: In Wet Pond design, there is no $WQ_v\text{-ED}$ orifice. All of the 1-year, 24-hour volume is retained.

Figure 10.5.3- Outlet structure profile

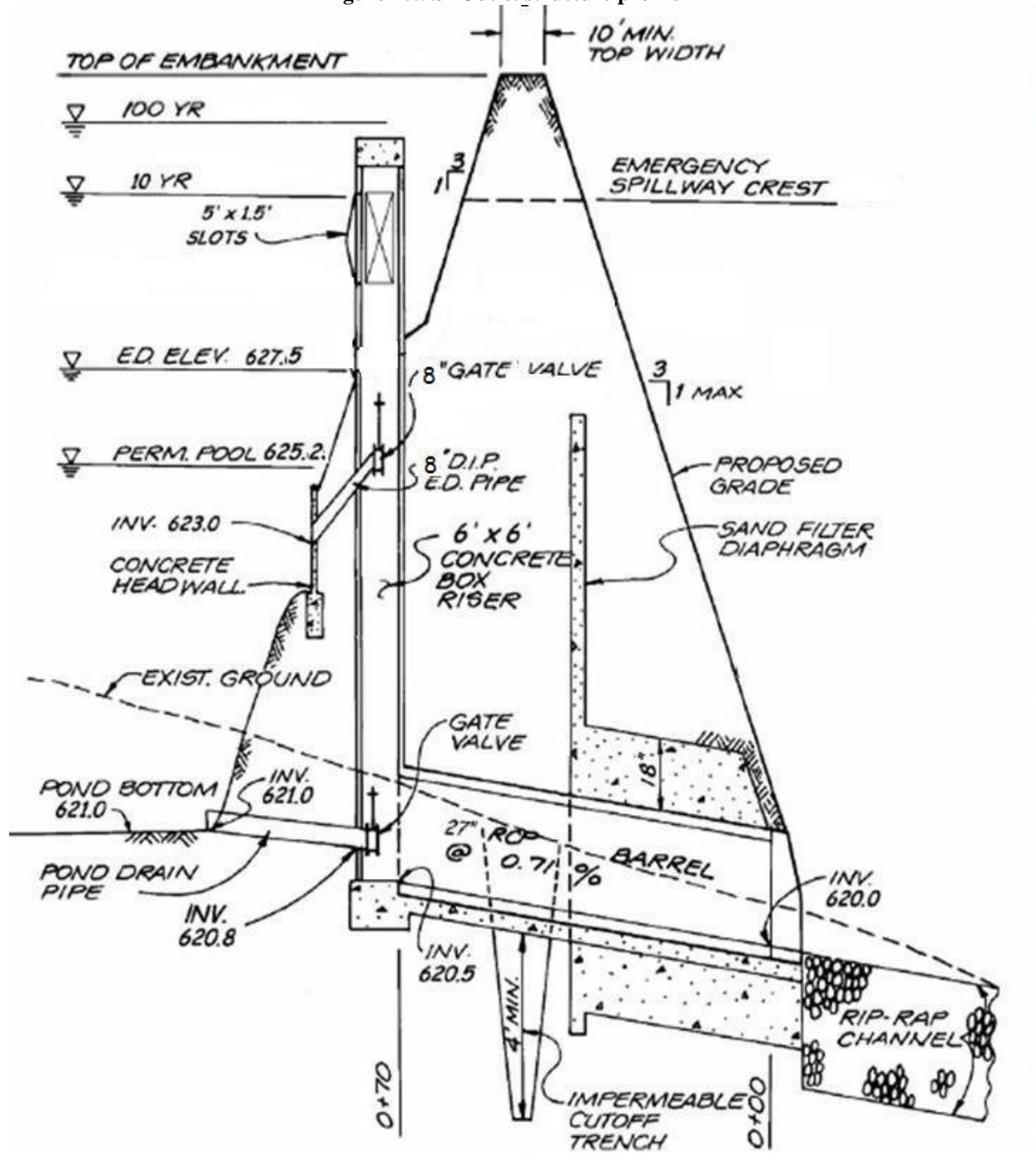

New York State Stormwater Management Design Manual

Chapter 10: Enhanced Phosphorus Removal Supplement

Section 10.5 Design Examples

Step 7. Set the C_{p_v} pool elevation. Compute C_{p_v} -ED orifice size, compute release rate for C_{p_v} control and establish elevation.

CP_v Sizing for Wet Ponds:

To determine the required C_{p_v} , a TR-55 model was developed to demonstrate increasing the elevation of the pond and the sizing of a C_{p_v} outlet to achieve a center of mass detention time (CMDT) of at least 24 hours (24-hour extended detention of the 1-year, 24-hour storm event).

Based on the TR-55 output data:

- Required C_{p_v} storage to meet 24-hour CMDT = 3.09 ac-ft
- Diameter of C_{p_v} -ED orifice = 4.4 inches at an elevation of 627.5 (determined from TR-55 model)
- Overflow Weir = 100' wide earth spillway at 628.75 (not shown on the schematics)
- Required CMDT = 25.2 hrs

CP_v Sizing for Wet Extended Detention Pond:

The WQ_v for enhanced phosphorus removal is sized for the 1-year event and the WQ_v -ED orifice is sized to release the ED_v within 24 hours. According to step 6 the orifice diameter calculated to release the 2.55 ac-ft WQ_v within 24 hours (resulting in a release rate = 1.29 cfs). Therefore, the C_{p_v} requirements are essentially included in the design. No additional volume is recommended. Based on the TR-55 output data, a CMDT of 23 hours was achieved in this design. Additional detention may be achieved by either increasing pond volume or an additional practice or control at the outlet of the pond to meet the C_{p_v} requirement (not included in example).

See Chapter 8, Section 8.2 for example calculations for the remaining steps, which cover calculations for Step 8: calculate Q_{p10} (10-year storm) release rate and water surface elevations; Step 9: calculate Q_{p100} (100-year storm) release rate and water surface elevation, size emergency spillway, calculate 100-year water surface elevation, and Step 10: check for safe passage of Q_{p100} under ultimate build-out conditions and set top of embankment elevation.

10.5.4 Sand Filter Design Example

New York State Stormwater Management Design Manual

Chapter 10: Enhanced Phosphorus Removal Supplement

Section 10.5 Design Examples

See Chapter 8, Section 8.3 Sand Filter Design Example for the complete example, figures, and calculations. The following shows only the elements of the example that have changed for enhanced phosphorus removal and does not address required water quantity controls.

This design example focuses on the design of a sand filter for a 4.5-acre catchment of Lake Center, a hypothetical commercial site located in the New York City watershed (east of Hudson). A five-story office building and associated parking are proposed within the catchment. The layout is shown in Chapter 8, Figure 8.14. The catchment has 3.05 acres of impervious cover (i.e., the site is 68% impervious). The pre-developed site is a mixture of forest and meadow. On-site soils are predominantly HSG “B” soils. Base data and hydrologic data are shown below and are available in Section 8.3.

Base Data

Location: New York City watershed (east-of-Hudson)

Site Area = Total Drainage Area (A) = 4.50 ac

Impervious Area = 3.05 ac; or $I = 3.05/4.50 = 68\%$

Soils Type “B”

Hydrologic Data

	Pre	Post
CN	58	85
t_c (hr)	0.44	0.2

The storm distribution type falls under type III. The rainfall for different storm frequencies for this example also reflects the corresponding amount of rain for this location as described in Example 1 of this section. Calculation of the time of concentration is based on the 2-year rainfall event (3.5 inches).

This step-by-step example will focus on meeting the water quality requirements. Channel protection control, overbank flood control and extreme flood control are not addressed in this example. Therefore, a detailed hydrologic analysis is not presented. For an example of detailed sizing calculations, consult

New York State Stormwater Management Design Manual

Chapter 10: Enhanced Phosphorus Removal Supplement

Section 10.5 Design Examples

Example 8.2 of Chapter 8. In general, the primary function of sand filters is to provide water quality treatment and not large storm attenuation. As such, flows in excess of the water quality volume are typically routed to bypass the facility. Where quantity control is required, bypassed flows can be routed to conventional detention basins (or some other facility such as underground storage vaults see Section 4.3).

The computations for the filter design for enhanced phosphorus removal begin with the site hydrologic input parameters and preliminary hydrologic calculations. These inputs are then used to obtain a WQ_v . Once the source control options are evaluated and incorporated in the site plan, a final WQ_v and flow rate is determined. Based on the discharge rate necessary, flow splitters are designed, and finally the filter design is completed.

Step 1. Develop Site Hydrologic Input Parameters and Calculate Water Quality Volume (see Table 10.5.9)

Water Quality Volume, WQ_v

The design storm is the 1-year, 24-hour, type III rainfall event. Consulting Figure 10.1, use 2.8-inches as the 1-year rainfall event based on the site location.

In final stabilization of the site, soil decompaction practices are applied to all disturbed area. Because of soil restoration practice, hydrologic soil group curve numbers applied to the grass areas are kept at their pre-construction value.

Using TR-55 and the post-development watershed, the resulting peak runoff rate is = 5.4 cfs.

The following provides a summary of TR-55 hydrologic calculation for WQ_v and discharge rate:

New York State Stormwater Management Design Manual

Chapter 10: Enhanced Phosphorus Removal Supplement

Section 10.5 Design Examples

Table. 10.5.9			
Inputs	Parameter	Value	Units
Site Acreage	A	4.5	Acres
Impervious Area	IA	3.05	Acres
Impervious Cover %	I	67.78	%
1-yr Rainfall (type III)	P	2.8	Inches
Curve Number (CN)		85	
Runoff Volume	$WQ_v = \text{Area} * \text{runoff depth}$	22869.00	ft ³
Initial abstraction (Ia)	$(200/CN)-2$	0.35	
	Ia/P	0.13	
qu (from NRCS Exhibit 4-III)		550	csn/in
Qa (runoff depth TR-55)		1.42	Inch
		for tc = 0.2	Hour
Qwq=(qu csm/in) (area ac/640ac/sq mi.) (Qa")		5.41	Cfs
Volume		23,224.37	ft ³

Therefore:

$$WQ_v = 0.54 \text{ ac-ft or } 23,224\text{ft}^3$$

New York State Stormwater Management Design Manual

Chapter 10: Enhanced Phosphorus Removal Supplement

Section 10.5 Design Examples

Table 10.5.10 Site Hydrology					
Condition	CN	Q_{1-yr} cfs	Q_{2-yr} cfs	Q_{10-yr} cfs	Q_{100-yr} Cfs
Pre-Developed	58	0.15	1.0	3.5	10.1
Post-Developed	85	5.4	8.2	13.6	23.8

Step 2. Evaluate the Development Site for Appropriate Source Control Practice and Application of Surface Sand Filter.

Grass swales and rain gardens are found to be suitable for this site. Infiltration capacity of the site (HSG B) allows infiltration and reduction of the runoff volume. The conventional plan identified 8 traffic islands which can be used for siting of a rain garden or bioretention area. A section of the conveyance system is also modified to collect the sheet flow and shallow concentrated flow into a grass swale. Grass swales allow some storage and infiltration. By incorporating these practices, the plan meets the source control requirement for routing 20% of impervious area through BSD practices.

$$3.05 \text{ acres} * 43,560 * 0.2 = 26,572 \text{ ft}^2$$

About 0.6 acre of the site will be connected to a bioretention area with infiltration capacity (without underdrain pipe) and a grass swale. Bioretention area calculations are similar to example 1 of this section. Swale capacity is calculated using standard open-channel hydraulic design calculations to maintain shallow depths and low velocities.

For the design of filters, head limitations are evaluated. Existing ground elevation at the practice location is 222.0 feet, mean sea level. Soil boring observations reveal that the seasonally high water table is at 211.0 feet. Adjacent drainage channel invert is at 213.0 feet. See Figure 10.5.4.

Step 3. Compute Source Control Flow Reduction

The site is designed to route the runoff from 0.6 acre of the impervious area through a bioretention area, overflow to an open channel and eventually flow to the proposed filter system. Bioretention storage is sized similar to the rain gardens in Example 1 provided in this Chapter. An overflow is designed to convey the overflow from the bioretention cell from larger storms into the swale.

New York State Stormwater Management Design Manual

Chapter 10: Enhanced Phosphorus Removal Supplement

Section 10.5 Design Examples

Contributing areas consist of 0.6 acre of rooftop, and 1 acre of grass area. About 300 ft² of bioretention area is considered for each 1000 ft² of rooftop, which results in a total bioretention area of 6,500 ft². The rest of the impervious and landscaped areas discharge to a grass swale, which also conveys the overflow from the bioretention area. Table 10.5.11 shows the calculation for sizing of the bioretention areas.

New York State Stormwater Management Design Manual

Chapter 10: Enhanced Phosphorus Removal Supplement

Section 10.5 Design Examples

Table 10.5.11. Summary of Bioretention Area Sizing		
Calculate storage capacity of bioretention area		
WQV		1 unit
Solve for drainage layer and soil media storage volume:		
$V_{SM} = A_{RG} \times D_{SM} \times P_{SM}$		
$V_{DL} = A_{RG} \times D_{DL} \times P_{DL}$		
where:		units
A_{RG} = proposed rain garden surface area (ft ²)	6500	ft ²
D_{SM} = depth soil media = 24 inches (ft)	2	ft
D_{DL} = depth drainage layer = 6 inches (ft)	0.5	ft
P_{SM} = porosity of soil media	0.2	
P_{DL} = porosity of drainage layer = 0.40	0.4	
V_{SM} = storage volume in soil media	2,600	ft ³
V_{DL} = storage volume in drainage layer	1,300	ft ³
D_P = ponding depth	0.50	ft
$WQV = V_{SM} + V_{DL} + (D_P \times A_{RG})$	7,150	ft ³
Units		1
Reduction in WQV in Filter (ft³)		7,150 ft ³

New York State Stormwater Management Design Manual

Chapter 10: Enhanced Phosphorus Removal Supplement

Section 10.5 Design Examples

A grass swale is designed to convey the runoff from this sub-catchment. The grading of the site is planned to be less than 4% slope so no check dams are required and the swale provides conveyance with some infiltration and filtering of runoff. Routing the flow through the grass swale increases the time of concentration.

The final water quality volume for the filter can be found by subtracting the volume in the BSD components from the water quality volume in the traditional site design or:

$$WQ_v = 23,224 \text{ ft}^3 - 7,150 \text{ ft}^3 = 16,074 \text{ ft}^3$$

Step 4. Compute Available Head and Peak Discharge (Q_{wQ}).
--

Determine available head (See Figure 10.5.4):

The low point at the parking lot is 223.5. Subtract 2' to pass the Q_{10} discharge (221.5) and a half foot for the inflow channel to the facility (221.0). The low point at the channel invert, is 213.0. Set the outfall underdrain pipe 1.0' above the drainage channel invert and add 0.5' to this value for the drain slope (214.5). Add to this value 8" for the gravel blanket on top of the underdrains and 18" for the sand bed (216.67). The total available head is 221.0 - 216.67 or 4.33 feet. Therefore, the available average depth (h_f) = $4.33' / 2 = 2.17$ feet.

Figure 10.5.4 Available Head

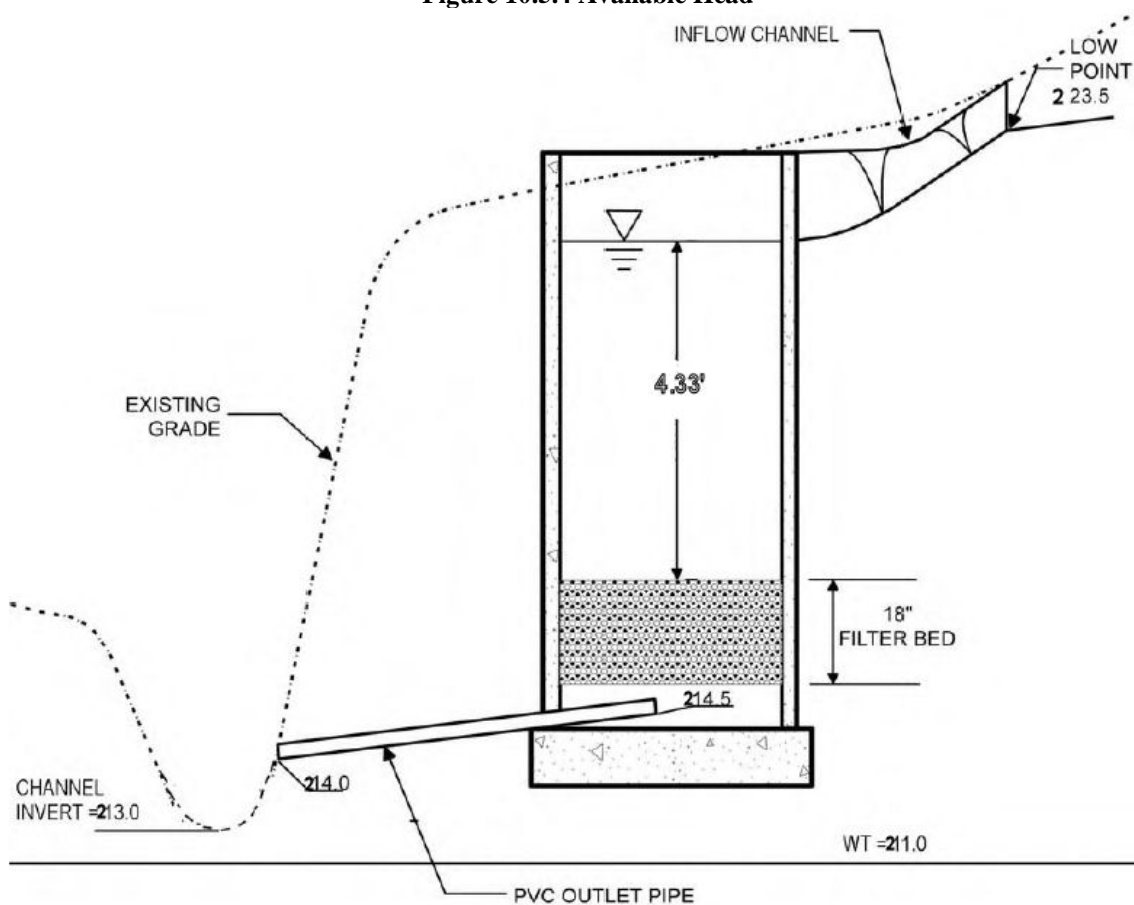

Compute Peak Water Quality Discharge:

The peak rate of discharge for the water quality design storm is needed for the sizing of diversion structures. The discharge rate is derived from the hydrology calculation in Table 10.5.9. A similar calculation is performed to incorporate the flow reduction and increase time of concentration and peak reduction as a result of the BSD approach. The source control practices discussed above result in reduction of peak discharge by 12%. The flow splitter outlet structure is designed to convey the 1-year storm to the sedimentation chamber and filter and safely bypass the 10-year storm to the conveyance system.

Step 5. Sizing of Diversion Structure and Filtering System

At this point, all the steps are similar to steps 4 through 9 of Chapter 8.3 of this manual. The methodology for sizing of flow splitter outlet structure for diversion of the design storm (1-year), filter

New York State Stormwater Management Design Manual

Chapter 10: Enhanced Phosphorus Removal Supplement

Section 10.5 Design Examples

bed chamber volume within practice, filter bed overflow weir size and sedimentation chamber, all remain the same as defined in Chapter 8. The key equations include:

Orifice equation for sizing of diversion structure low flow orifice:

$$Q = CA(2gh)^{1/2} ;$$

Weir equation for sizing of the 10-year storm by pass weir:

$$Q = CLH^{3/2}$$

Darcy's Law for sizing of the filter bed

$$A_f = WQ_v (d_f) / [k (h_f + d_f) (t_f)]$$

The requirement for enhanced phosphorus removal for sand filters is similar to conventional sizing of the filtering systems. As stated in Chapter 6, the entire treatment system (including pretreatment) shall be sized to temporarily hold at least 75% of the WQ_v prior to filtration. The following includes a summary of the design calculations for sand filter:

New York State Stormwater Management Design Manual

Chapter 10: Enhanced Phosphorus Removal Supplement

Section 10.5 Design Examples

Table 10.5.12. Summary of Filter Bed Design			
Required Filter Bed Area filtration chamber $A_f = (WQ_v) (d_f) / [(k) (h_f + d_f) (t_f)]$	Parameter	Value	Units
Design Volume (WQ_v)	WQ_v	16,074.00	ft ³
Filter Bed depth	d_f	1.5	ft
Coef. f Permeability of Filter media	K	3.5	ft/day
Avg. height of water above filter bed	h_f	2.18	ft
Design filter bed drain time	t_f	1.67	days
Surface Area	A_f	1120.94	ft ²
Width (Define L/W)	W	25	ft
Length	L	45	ft
Practice surface area		1125	ft ²
Porosity (n)		0.4 for sand	
Min. total volume $V_{min}=0.75Wq_v$		12055.5	ft ³
Pretreatment volume $P_v=.25Wq_v$		4018.5	ft ³
pretreatment depth		2.5	ft
pretreatment surface area		1608	ft ²
Pretreatment length		65	ft
$P_{vs}=P_v+P_vh_f$		11,031	ft ³
$V_f=A_f(d_f)(n)$		675	ft ³
$V_{f-temp}=2h_fA_f$		4905	ft ³
$V_{min}=P_v+V_f+V_{f-temp}$		16,611	ft ³

New York State Stormwater Management Design Manual

Chapter 10: Enhanced Phosphorus Removal Supplement

Section 10.5 Design Examples

References:

- Burton, G.A. Jr., and R. Pitt, Stormwater Effects Handbook: A Tool Box for Watershed Managers, Scientists, and Engineers. CRC Press, Inc., Boca Raton, FL. 911 pgs.
2002.
- Cerrelli, G. A., "Stormwater Management Impacts Resulting from the Volumetric Abstraction of Runoff from Frequent Storms per PADEP CG-1." Villanova SWM Conference proceedings, 2007. 7pp.
- Hunt, W. "Bioretention Performance, Design, Construction, and Maintenance." NC State Cooperative Extension, North Carolina A&T State University, Urban waterways. 2006. 10pp.
- Minnesota Stormwater Manual, Minnesota Pollution Control Agency, 2005.
<http://www.pca.state.mn.us/water/stormwater/stormwater-manual.html#manual> visited 03/08.
- Pitt, R. Maestre A., Morquecho R. "The National Stormwater Quality Database (NSQD, version 1.1)" 2004.
- Pitt, R. E. Excerpt report, Particulate Phosphorus for Use in New York. 2005. 13pp.
- Strecker, E.W ., W.C Huber, J.P. Heaney, D. Bodine, J.J. Sansalone, M.M. Quigley, D. Pankani, M. Leisenring, and P. Thayumanavan, "Critical Assessment of Stormwater Treatment and Control Selection Issues." Water Environment Research Federation, Report No. 02-SW-1. ISBN 1-84339-741-2. 290pp.
- Wilks, D.S. & Cember, R.P. (1993). Atlas of Precipitation Extremes for the North-eastern United States and South-eastern Canada. Publication No. Cornell University, Ithaca. RR 93-5

References

- Allen, P. and R. Narramore. 1985. Bedrock controls on stream channel enlargement with urbanization, North Central Texas. *Water Resources Bulletin*. 21(6): 1037-1048.
- Bannerman, R.; D. Owens; R. Dodds; and N. Hornewer. 1993. Sources of Pollutants in Wisconsin Stormwater. *Water Science and Technology*. 28(3-5): 241-259.
- Booth, D., D. Montgomery, and J. Bethel. 1996. Large woody debris in the urban streams of the Pacific Northwest. *In Effects of Watershed development and Management on Aquatic Systems*. L. Roesner (ed.) Engineering Foundation Conference. Proceedings. Snowbird, UT. August 4-9, 1996. Pp. 178-197
- Booth, D. 1990. Stream channel incision following drainage basin urbanization. *Water Resources Bulletin*. 26(3): 407-417.
- Caraco, D. and R. Claytor. 1997. Stormwater BMP design supplement for cold climates. Center for Watershed Protection. Ellicott City, MD
- Cappiella, K. and K. Brown. 2001. Impervious Cover and Land Use in the Chesapeake Bay Watershed. Center for Watershed Protection, Ellicott City, Maryland.
- City of Austin, TX. 1988. Water Quality Management. In, Environmental Criteria Manual. Environmental and Conservation Services. Austin, TX.
- Claytor, R. and T. Schueler. 1996. Design of Stormwater Filtering Systems. Center for Watershed Protection. Ellicott City, MD.
- Crawford, J. and D. Lenat. 1989. Effects of land use on water quality and the biota of three streams in the Piedmont Province of North Carolina. USGS. Water Resources Investigations Report 89-4007. Raleigh, NC, 67 pp.
- Crunkilton, R. et al. 1996. Assessment of the response of aquatic organisms to long-term insitu exposures of urban runoff. In: *Effects of Watershed Development and Management on Aquatic Ecosystems: Proceedings of an Engineering Foundation Conference*. Snowbird, UT.
- Demers, C. and R. Sage. 1990. Effects of road deicing salts on chloride levels in four Adirondack streams. *Water, Air and Soil Pollution*. 49: 369-373.
- Dunne T. and L. Leopold. 1978. *Water in Environmental Planning*. W.H. Freeman and Company, New York, NY.
- Galli, J. 1991. Thermal impacts associated with urbanization and stormwater management best management practices. Metropolitan Washington Council of Governments. Maryland Department of Environment. Washington, D.C. 188 pp.

New York State Stormwater Management Design Manual

References

- Galli, J. 1990. Peat-Sand Filters: A Proposed Stormwater Management Practice for Urbanized Areas. MWCOG. Washington, DC.
- Hammer, T. 1972. Stream channel enlargement due to urbanization. *Water Resources Research*. 8(6): 1530-1540.
- Hollis, F. 1975. The effects of urbanization on floods of different recurrence intervals. *Water Resources Research*, 11:431-435.
- Horner, et al. 1996. Watershed Determinates of Ecosystem Functioning. In: *Effects of Watershed Development and Management on Aquatic Ecosystems*. Roesner, L.A. (editor). Snowbird Utah. August 4-9, 1996. Engineering Foundation.
- Kundell, J. and T. Rasmussen. 1995. Recommendations of the Georgia Board of Regent's scientific panel on evaluating the erosion measurement standard defined by the Georgia erosion and sedimentation act. In *Proceedings of the 1995 Georgia Water Resources Conference*. Athens, Georgia.
- Leopold, L. 1994. *A View of the River*. Harvard University Press, Cambridge, MA.
- MacRae, C. 1996. Experience from morphological research on Canadian streams: is control of the two-year frequency runoff event the best basis for stream channel protection? In *Effects of Watershed development and Management on Aquatic Systems*. L. Roesner (ed.) Engineering Foundation Conference. *Proceedings*. Snowbird, UT. August 4-9, 1996. pp. 144-160.
- MacRae, C. and M. DeAndrea, 1999. Assessing the impact of urbanization on channel morphology. 2nd International Conference on Natural Channel Systems. Niagra Falls, OT.
- MacRae C. and A. Rowney. 1992. The role of moderate flow events and bank structure in the determination of channel response to urbanization. 45th Annual Conference. *Resolving Conflicts and Uncertainty in Water Management*. Proceeding of the Canadian Water Resources Association. June 1992. Kingston, Ontario.
- Maryland Department of the Environment (MDE). 2000. *Maryland Stormwater Design Manual*. Baltimore, MD.
- Masterson, J and R. Bannerman. 1994. Impacts of storm water runoff on urban streams in Milwaukee Co., Wisconsin. In *Proceedings of the American Water Resources Association, National Symposium on Water Quality*. pp. 123-133.
- May, C. R. Horner, J. Karr, B. Mar, and E. Welch. 1997. Effects of Urbanization on Small Streams In the Puget Sound Lowland Ecoregion. *Watershed Protection Techniques*, 2(4): 483-494.
- Metropolitan Washington Council of Governments (MWCOG), 1992. *Watershed Restoration Sourcebook*. Department of Environmental Programs, MWCOG, Washington, DC.
- Metropolitan Washington Council of Governments (MWCOG). 1989. *Save the Anacostia Report*. Metropolitan Washington Council of Governments. Washington, D.C.

New York State Stormwater Management Design Manual

References

- McCuen, R. 1979. Downstream effects of stormwater management basins. *Journal of the Hydraulics Division, ASCE*, Vol. 105, No. HY11.
- McCuen R. and G. Moglen. 1988. Multicriterion stormwater management methods. *Journal of Water Resources Planning and Management*. (114) 4.
- Monroe County Environmental Management Council. 1987. The use of road deicing salt on state roads in Monroe County. Monroe County, NY.
- Morisawa, M and E. La Flure. 1979. Hydraulic geometry, stream equilization and urbanization. In the Proceedings of the Tenth Annual Geomorphology Symposia Series entitled "Adjustments of the Fluvial System" held in Binghamton, NY. September 21-22, 1979. Kendall/Hunt Publishing Company, Dubuque, IA.
- Natural Resources Conservation Service. 1986. Urban Hydrology for Small Watersheds. Technical Release No. 55. USDA. Washington D.C.
- Natural Resources Conservation Service. 1984. Engineering Field Manual for Conservation Practices. USDA. Washington D.C.
- Natural Resources Defense Council. 2000. Testing the Waters: A Guide to Water Quality at Vacation Beaches. Available online at. <http://www.nrdc.org>
- New York City Department of Environmental Protection (NYC DEP). 1999. Development of a water quality guidance value for Phase II Total Maximum Daily Loads (TMDLs) in the New York City Reservoirs. Prepared by Dr. Kimberlee Kane, Dr. Michael A. Principe, and Dr. Carol Stepczuk, Division of Drinking Water Quality Control, Bureau of Water Supply, Quality and Protection..
- New York Department of Environmental Conservation (NY DEC). 1989. Guidelines for Design of Dams. Albany, NY.
- Oberts, G. 1994. Influence of snowmelt dynamics on stormwater runoff quality. *Watershed Protection Techniques*. 1(2):55-61.
- Pitt, R. 1995. Effects of Urban Runoff on Aquatic Biota. In *Handbook of Ecotoxicology*. Lewis Publishers/CRC Press, Inc., Boca Raton, Florida.
- Rabanal, F. and T. Grizzard. 1995. Concentrations of selected constituents in runoff from impervious surfaces in four urban land use catchments of different land use. In Proceedings of the 4th Biennial Stormwater Research Conference. Clearwater, FL.
- Richey, J.S. 1982. Effects of urbanization on a lowland stream in urban Washington. PhD Dissertation. University of Washington.
- Sauer V. *et al.* 1983. Flood Characteristics of Urban Watersheds in the United States. US Geological Survey Water Supply Paper 2207.
- Schueler, T. 1999. Microbes and Urban Watersheds. *Watershed Protection Techniques*. 3(1): 551-596.
- Schueler, T. 1994. The Importance of Imperviousness. *Watershed Protection Techniques* 1(3): 100-111.

New York State Stormwater Management Design Manual

References

- Schueler, T. 1995. Site Planning for Urban Stream Protection. Center for Watershed Protection, Ellicott City, Maryland.
- Schueler, T. 1987. Controlling urban runoff: a practical manual for planning and designing urban BMPs. Metropolitan Washington Council of Governments. Washington, DC
- Scott, J., C. Steward and Q. Stober. 1986. Effects of urban development on fish population dynamics in Kelsey Creek, Washington. Transactions of the American Fisheries Society. 115:555-567.
- Smullen, J. and K. Cave. 1998. Updating the U.S. Nationwide Urban Runoff Quality Database. 3rd International Conference on Diffuse Pollution. August 31 - September 4, 1998. Scottish Environment Protection Agency, Edinburg Scotland.
- Spence, B., G. Lomnický, R. Hughes, and R. Novitzki. 1996. An Ecosystem Approach to Salmonid Conservation. TR-401-96-6057. ManTech Environmental Research Services Corporation, Corvallis, OR. (Available on the NMFS-NWR website: <http://www.nwr.noaa.gov>)
- Spinello, A.G., D.L. Simmons. 1992. Base Flow of 10 South-Shore Streams, Long Island, New York, 1976-1985, and the Effects of Urbanization on Base Flow and Flow Duration. United States Geological Survey. *Water Resources Investigative Report* 90-4205.
- Steuer, Jeffrey, William Selbig, Nancy Hornewer, and Jeffrey Prey. 1997. Sources of Contamination in an Urban Basin in Marquette, Michigan and an Analysis of Concentrations, Loads, and Data Quality. U.S. Geological Survey, Water-Resources Investigations Report 97-4242.
- Taylor, B.L. 1993. The influences of wetland and watershed morphological characteristics and relationships to wetland vegetation communities. Master's thesis. Dept. of Civil Engineering. University of Washington, Seattle, WA.
- Trimble, S. 1997. Contribution of stream channel erosion to sediment yield from an urbanizing watershed. *Science*. 278: 1442-1444.
- US Environmental Protection Agency. 1993. Guidance Specifying Management Measures for Sources of Nonpoint Pollution in Coastal Waters. EPA-840-B-92-002. U.S. EPA, Office of Water, Washington, DC
- Waschbusch *et al.* 2000. Sources of phosphorus in stormwater and street dirt from two urban residential basins in Madison, Wisconsin, 1994-1995. In: National Conference on Tools for Urban Water Resource Management and Protection. US EPA February 2000: pp. 15-55.
- Washington State Department of Ecology. 1992. Stormwater Management Manual for the Puget Sound Basin (Technical Manual).
- Winer, R. 2000. National Pollutant Removal Database for Stormwater Treatment Practices: 2nd Edition. Center for Watershed Protection. Ellicott City
- Woodward - Clyde Consultants 1992. Source Identification and Control Report. Prepared for the Santa Clara Valley Nonpoint Source Control Program. Oakland, California.

New York State Stormwater Management Design Manual

References

- Yoder, C., R. Miltner, and D. White. 1999. Assessing the Status of Aquatic Life Designated Uses in Urban and Suburban Watersheds. pp 16-28. In R. Kirschener (ed.) Proceedings of the *National Conference on Retrofit Opportunities for Water Resource Protection in Urban Environments*. EPA/625/R-99/002
- Yoder C., 1991. The integrated biosurvey as a tool for evaluation of aquatic life use attainment and impairment in Ohio surface waters. in *Biological Criteria: Research and Regulation*; 1991.

Glossary

ANTI-SEEP COLLAR - An impermeable diaphragm usually of sheet metal or concrete constructed at intervals within the zone of saturation along the conduit of a principal spillway to increase the seepage length along the conduit and thereby prevent piping or seepage along the conduit.

ANTI-VORTEX DEVICE - A device designed and placed on the top of a riser or at the entrance of a pipe to prevent the formation of a vortex in the water at the entrance.

AQUATIC BENCH - A ten to fifteen foot wide bench which is located around the inside perimeter of a permanent pool and is normally vegetated with aquatic plants; the goal is to provide pollutant removal and enhance safety in areas using stormwater pond SMPs.

AQUIFER - A geological formation which contains and transports groundwater.

“AS-BUILT” - Drawing or certification of conditions as they were actually constructed.

BAFFLES - Guides, grids, grating or similar devices placed in a pond to deflect or regulate flow and create a longer flow path.

BANKFULL FLOW - The condition where streamflow just fills a stream channel up to the top of the bank and at a point where the water begins to overflow onto a floodplain.

BARREL - The closed conduit used to convey water under or through an embankment: part of the principal spillway.

BASE FLOW - The stream discharge from ground water.

BERM - A shelf that breaks the continuity of a slope; a linear embankment or dike.

Better site design - Incorporates non-structural and natural approaches to new and redevelopment projects to reduce effects on watersheds by conserving natural areas, reducing impervious cover and better integrating stormwater treatment.

BIORETENTION - A water quality practice that utilizes landscaping and soils to treat urban stormwater runoff by collecting it in shallow depressions, before filtering through a fabricated planting soil media.

CHANNEL - A natural stream that conveys water; a ditch or channel excavated for the flow of water.

CHANNEL STABILIZATION - Erosion prevention and stabilization of velocity distribution in a channel using jetties, drops, revetments, structural linings, vegetation and other measures.

CHECK DAM - A small dam constructed in a gully or other small watercourse to decrease the stream flow velocity (by reducing the channel gradient), minimize channel scour, and promote deposition of sediment.

CHUTE - A high velocity, open channel for conveying water to a lower level without erosion.

CLAY (SOILS) - 1. A mineral soil separate consisting of particles less than 0.002 millimeter in equivalent diameter. 2. A soil texture class. 3. (Engineering) A fine grained soil (more than 50 percent passing the No. 200 sieve) that has a high plasticity index in relation to the liquid limit. (Unified Soil Classification System)

New York State Stormwater Management Design Manual

Glossary

COCONUT ROLLS - Also known as coir rolls, these are rolls of natural coconut fiber designed to be used for streambank stabilization.

COMPACTION (SOILS) - Any process by which the soil grains are rearranged to decrease void space and bring them in closer contact with one another, thereby increasing the weight of solid material per unit of volume, increasing the shear and bearing strength and reducing permeability.

CONDUIT - Any channel intended for the conveyance of water, whether open or closed.

Conservation design - Includes laying out the elements of a development project in such a way that the site design takes advantage of a site's natural features, preserves the more sensitive areas and identifies any site constraints and opportunities to prevent effects.

CONTOUR - 1. An imaginary line on the surface of the earth connecting points of the same elevation. 2. A line drawn on a map connecting points of the same elevation.

Conventional site design - For the purposes of this document, conventional design can be viewed as the style of suburban development that has evolved during the past 50 years and generally involves larger lot development, clearing and grading of significant portions of a site, wider streets and larger cul-de-sacs, enclosed drainage systems for stormwater conveyance and large "hole-in-the-ground" detention basins.

CORE TRENCH - A trench, filled with relatively impervious material intended to reduce seepage of water through porous strata.

CRADLE - A structure usually of concrete shaped to fit around the bottom and sides of a conduit to support the conduit, increase its strength and in dams, to fill all voids between the underside of the conduit and the soil.

CREST - 1. The top of a dam, dike, spillway or weir, frequently restricted to the overflow portion. 2. The summit of a wave or peak of a flood.

CRUSHED STONE - Aggregate consisting of angular particles produced by mechanically crushing rock.

CURVE NUMBER (CN) - A numerical representation of a given area's hydrologic soil group, plant cover, impervious cover, interception and surface storage derived in accordance with Natural Resources Conservation Service methods. This number is used to convert rainfall volume into runoff volume.

CUT - Portion of land surface or area from which earth has been removed or will be removed by excavation; the depth below original ground surface to excavated surface.

CUT-AND-FILL - Process of earth moving by excavating part of an area and using the excavated material for adjacent embankments or fill areas.

CUTOFF - A wall or other structure, such as a trench, filled with relatively impervious material intended to reduce seepage of water through porous strata.

CZARA - Acronym used for the Coastal Zone Act Reauthorization Amendments of 1990. These amendments sought to address the issue of nonpoint source pollution issue by requiring states to develop Coastal Nonpoint Pollution Control Programs in order to receive federal funds.

DAM - A barrier to confine or raise water for storage or diversion, to create a hydraulic head, to prevent gully erosion, or for retention of soil, sediment or other debris.

DESIGN GUIDANCE - Features that enhance the performance but may not be necessary for all applications and may be modified if it does not improve the performance of the practices in a specific site.

DETENTION - The temporary storage of storm runoff in a SMP with the goals of controlling peak discharge rates and providing gravity settling of pollutants.

DETENTION STRUCTURE - A structure constructed for the purpose of temporary storage of stream flow or surface runoff and gradual release of stored water at controlled rates.

New York State Stormwater Management Design Manual

Glossary

DEVIATION FROM STANDARDS - Non-compliance with the technical standards set by this technical standard. To be in compliance with this technical standards (Design Manual), projects must meet both performance and sizing criteria. The Department will only accept deviations from the technical standards that involve the use of an alternative post-construction stormwater management practice or a modification to one of the practices from this technical standard that has been demonstrated to be equivalent to this technical standard.

DIKE - An embankment to confine or control water, for example, one built along the banks of a river to prevent overflow or lowlands; a levee.

DISTRIBUTED RUNOFF CONTROL (DRC) - A stream channel protection criteria which utilizes a non-uniform distribution of the storage stage-discharge relationship within a SMP to minimize the change in channel erosion potential from predeveloped to developed conditions.

DISTURBED AREA - An area in which the natural vegetative soil cover has been removed or altered and, therefore, is susceptible to erosion.

DIVERSION - A channel with a supporting ridge on the lower side constructed across the slope to divert water from areas where it is in excess to sites where it can be used or disposed of safely. Diversions differ from terraces in that they are individually designed.

DRAINAGE - 1. The removal of excess surface water or ground water from land by means of surface or subsurface drains. 2. Soils characteristics that affect natural drainage.

DRAINAGE AREA (WATERSHED) - All land and water area from which runoff may run to a common (design) point.

DROP STRUCTURE - A structure for dropping water to a lower level and dissipating surplus energy; a fall. The drop may be vertical or inclined.

DRY SWALE - An open drainage channel explicitly designed to detain and promote the filtration of stormwater runoff through an underlying fabricated soil media.

Effective Bypass - The runoff that leaves the site untreated. Example: flow that pass over the weir in a filter system not treated (i.e. not effected by the primary removal mechanism).

EMERGENCY SPILLWAY - A dam spillway designed and constructed to discharge flow in excess of the principal spillway design discharge.

ENERGY DISSIPATOR - A designed device such as an apron of rip-rap or a concrete structure placed at the end of a water transmitting apparatus such as pipe, paved ditch or paved chute for the purpose of reducing the velocity, energy and turbulence of the discharged water.

EROSION - 1. The wearing away of the land surface by running water, wind, ice, or other geological agents, including such processes as gravitational creep. 2. Detachment and movement of soil or rock fragments by water, wind, ice or gravity. The following terms are used to describe different types of water erosion:

Accelerated erosion - Erosion much more rapid than normal, natural or geologic erosion, primarily as a result of the influence of the activities of man or, in some cases, of other animals or natural catastrophes that expose base surfaces, for example, fires.

Gully erosion - The erosion process whereby water accumulates in narrow channels and, over short periods, removes the soil from this narrow area to considerable depths, ranging from 1 or 2 feet to as much as 75 to 100 feet.

Rill erosion - An erosion process in which numerous small channels only several inches deep are formed. See rill.

Sheet erosion - The spattering of small soil particles caused by the impact of raindrops on wet soils. The loosened and spattered particles may or may not subsequently be removed by surface runoff.

New York State Stormwater Management Design Manual

Glossary

EROSIVE VELOCITIES - Velocities of water that are high enough to wear away the land surface. Exposed soil will generally erode faster than stabilized soils. Erosive velocities will vary according to the soil type, slope, structural, or vegetative stabilization used to protect the soil.

EXFILTRATION - The downward movement of water through the soil; the downward flow of runoff from the bottom of an infiltration SMP into the soil.

EXTENDED DETENTION (ED) - A stormwater design feature that provides for the gradual release of a volume of water over a 12 to 48 hour interval in order to increase settling of urban pollutants and protect downstream channels from frequent storm events.

EXTREME FLOOD (Q_F) - The storage volume required to control those infrequent but large storm events in which overbank flows approach the floodplain boundaries of the 100-year flood.

FILTER BED - The section of a constructed filtration device that houses the filter media and the outflow piping.

FILTER FENCE - A geotextile fabric designed to trap sediment and filter runoff.

FILTER MEDIA - The sand, soil, or other organic material in a filtration device used to provide a permeable surface for pollutant and sediment removal.

FILTER STRIP - A strip of permanent vegetation above ponds, diversions and other structures to retard flow of runoff water, causing deposition of transported material, thereby reducing sediment flow.

FINES (SOIL) - Generally refers to the silt and clay size particles in soil.

FLOODPLAIN - The land area that is subject to inundation from a flood that has a one percent chance of being equaled or exceeded in any given year. This is typically thought of as the 100-year flood.

FLOW SPLITTER - An engineered, hydraulic structure designed to divert a percentage of storm flow to a SMP located out of the primary channel, or to direct stormwater to a parallel pipe system, or to bypass a portion of baseflow around a SMP.

FOREBAY - Storage space located near a stormwater SMP inlet that serves to trap incoming coarse sediments before they accumulate in the main treatment area.

FREEBOARD (HYDRAULICS) - The distance between the maximum water surface elevation anticipated in design and the top of retaining banks or structures. Freeboard is provided to prevent overtopping due to unforeseen conditions.

FOURTH ORDER STREAM - Designation of stream size where many water quantity requirements may not be needed. A first order stream is identified by "blue lines" on USGS quad sheets. A second order stream is the confluence of two first order streams, and so on.

FRENCH DRAIN - A type of drain consisting of an excavated trench refilled with pervious material, such as coarse sand, gravel or crushed stone, through whose voids water percolates and flows to an outlet.

GABION - A flexible woven-wire basket composed of two to six rectangular cells filled with small stones. Gabions may be assembled into many types of structures such as revetments, retaining walls, channel liners, drop structures and groins.

GABION MATTRESS - A thin gabion, usually six or nine inches thick, used to line channels for erosion control.

GRADE - 1. The slope of a road, channel or natural ground. 2. The finished surface of a canal bed, roadbed, top of embankment, or bottom of excavation; any surface prepared for the support of construction, like paving or laying a conduit. 3. To finish the surface of a canal bed, roadbed, top of embankment or bottom of excavation.

GRASS CHANNEL - A open vegetated channel used to convey runoff and to provide treatment by filtering out pollutants and sediments.

New York State Stormwater Management Design Manual

Glossary

GRAVEL - 1. Aggregate consisting of mixed sizes of 1/4 inch to 3 inch particles which normally occur in or near old streambeds and have been worn smooth by the action of water. 2. A soil having particle sizes, according to the Unified Soil Classification System, ranging from the No. 4 sieve size angular in shape as produced by mechanical crushing.

GRAVEL DIAPHRAGM - A stone trench filled with small, river-run gravel used as pretreatment and inflow regulation in stormwater filtering systems.

GRAVEL FILTER - Washed and graded sand and gravel aggregate placed around a drain or well screen to prevent the movement of fine materials from the aquifer into the drain or well.

GRAVEL TRENCH - A shallow excavated channel backfilled with gravel and designed to provide temporary storage and permit percolation of runoff into the soil substrate.

Green Infrastructure – In the context of stormwater management, the term green infrastructure includes a wide array of practices at multiple scales to manage and treat stormwater, maintain and restore natural hydrology and ecological function by infiltration, evapotranspiration, capture and reuse of stormwater, and establishment of natural vegetative features. On a regional scale, green infrastructure is the preservation and restoration of natural landscape features, such as forests, floodplains and wetlands, coupled with policies such as infill and redevelopment that reduce overall imperviousness in a watershed or ecoregion. On the local scale green infrastructure consists of site- and neighborhood-specific practices and runoff reduction techniques. Such practices essentially result in runoff reduction and or establishment of habitat areas with significant utilization of soils, vegetation, and engineered media rather than traditional hardscape collection, conveyance and storage structures. Some examples include green roofs, trees and tree boxes, pervious pavement, rain gardens, vegetated swales, planters, reforestation, and protection and enhancement of riparian buffers and floodplains.

GROUND COVER - Plants which are low-growing and provide a thick growth which protects the soil as well as providing some beautification of the area occupied.

GULLY - A channel or miniature valley cut by concentrated runoff through which water commonly flows only during and immediately after heavy rains or during the melting of snow. The distinction between gully and rill is one of depth. A gully is sufficiently deep that it would not be obliterated by normal tillage operations, whereas a rill is of lesser depth and would be smoothed by ordinary farm tillage.

HEAD (HYDRAULICS) - 1. The height of water above any plane of reference. 2. The energy, either kinetic or potential, possessed by each unit weight of a liquid expressed as the vertical height through which a unit weight would have to fall to release the average energy possessed. Used in various terms such as pressure head, velocity head, and head loss.

HERBACEOUS PERENNIAL (PLANTS) - A plant whose stems die back to the ground each year.

HI MARSH - A pondscaping zone within a stormwater wetland which exists from the surface of the normal pool to a six inch depth and typically contains the greatest density and diversity of emergent wetland plants.

HI MARSH WEDGES - Slices of shallow wetland (less than or equal to 6 inches) dividing a stormwater wetland.

HOT SPOT - Area where land use or activities generate highly contaminated runoff, with concentrations of pollutants in excess of those typically found in stormwater.

HYDRAULIC GRADIENT - The slope of the hydraulic grade line. The slope of the free surface of water flowing in an open channel.

HYDROGRAPH - A graph showing variation in stage (depth) or discharge of a stream of water over a period of time.

HYDROLOGIC SOIL GROUP (HSG) - A Natural Resource Conservation Service classification system in which soils are categorized into four runoff potential groups. The groups range from A soils, with high permeability and little runoff production, to D soils, which have low permeability rates and produce much more runoff.

New York State Stormwater Management Design Manual

Glossary

HYDROSEED - Seed or other material applied to areas in order to re-vegetate after a disturbance.

HYPOXIA - Lack of oxygen in a waterbody resulting from eutrophication.

IMPERVIOUS COVER (I) - Impermeable surfaces that can not effectively infiltrate rainfall. This includes paved, concrete and gravel surfaces (i.e. parking lots, driveways, roads, runways and sidewalks); building rooftops and miscellaneous impermeable structures such as patios, pools, and sheds.

INDUSTRIAL STORMWATER PERMIT - An NPDES permit issued to a commercial industry or group of industries which regulates the pollutant levels associated with industrial storm water discharges or specifies on-site pollution control strategies.

INFEASIBLE - A practice that is not technologically possible, or not economically practicable and achievable in light of best industry practices.

INFILTRATION RATE (F_C) - The rate at which stormwater percolates into the subsoil measured in inches per hour.

INFLOW PROTECTION - A water handling device used to protect the transition area between any water conveyance (dike, swale, or swale dike) and a sediment trapping device.

LEVEL SPREADER - A device for distributing stormwater uniformly over the ground surface as sheet flow to prevent concentrated, erosive flows and promote infiltration.

Long term runoff volume - Total runoff over a long period of time (>25 years).

MANNING'S FORMULA (HYDRAULICS) - A formula used to predict the velocity of water flow in an open channel or pipeline:

$$V = \frac{1.486}{n} R^{2/3} S^{1/2}$$

Where V is the mean velocity of flow in feet per second; R is the hydraulic radius; S is the slope of the energy gradient or for assumed uniform flow the slope of the channel, in feet per foot; and n is the roughness coefficient or retardance factor of the channel lining.

MICROPOOL - A smaller permanent pool which is incorporated into the design of larger stormwater ponds to avoid resuspension or settling of particles and minimize impacts to adjacent natural features.

MICROTOPOGRAPHY - The complex contours along the bottom of a shallow marsh system, providing greater depth variation which increases the wetland plant diversity and increases the surface area to volume ratio of a stormwater wetland.

MULCH - Covering on surface of soil to protect and enhance certain characteristics, such as water retention qualities.

MUNICIPAL STORMWATER PERMIT - A SPDES permit issued to municipalities to regulate discharges from municipal separate storm sewers for compliance with EPA established water quality standards and/or to specify stormwater control strategies.

Natural areas - This is undisturbed land or previously disturbed land that has been restored and that retains pre-development hydrologic and water quality characteristics.

New development - Any land disturbance that does meet the definition of Redevelopment Activity included in this glossary.

New York State Stormwater Management Design Manual

Glossary

NITROGEN-FIXING (BACTERIA) - Bacteria having the ability to fix atmospheric nitrogen, making it available for use by plants. Inoculation of legume seeds is one way to insure a source of these bacteria for specified legumes.

Non-structural stormwater control – Natural measures that reduce pollution level, do not require extensive construction or engineering efforts and/or promote pollutant reduction by eliminating the pollutant source.

NORMAL DEPTH - Depth of flow in an open conduit during uniform flow for the given conditions.

NPDES - Acronym for the National Pollutant Discharge Elimination System, which regulates point source and non-point source discharge.

Off-site - Areas outside of the “project area” that may contribute to the same design point as the “project area.”

OFF-LINE - A stormwater management system designed to manage a storm event by diverting a percentage of stormwater events from a stream or storm drainage system.

ON-LINE - A stormwater management system designed to manage stormwater in its original stream or drainage channel.

ONE YEAR STORM (Q_{P1}) - A stormwater event which statistically has a 100% chance of being equaled or exceeded on average in a given year.

ONE HUNDRED YEAR STORM (Q_{P100}) A extreme flood event which statistically has a one percent chance of being equaled or exceeded in any given year..

OPEN CHANNELS - Also known as swales, grass channels, and biofilters. These systems are used for the conveyance, retention, infiltration and filtration of stormwater runoff.

OUTFALL - The point where water flows from a conduit, stream, or drain.

OUTLET - The point at which water discharges from such things as a stream, river, lake, tidal basin, pipe, channel or drainage area.

OUTLET CHANNEL - A waterway constructed or altered primarily to carry water from man-made structures such as terraces, subsurface drains, diversions and impoundments.

PEAK DISCHARGE RATE - The maximum instantaneous rate of flow during a storm, usually in reference to a specific design storm event.

Performance criteria - The design criteria listed under the “Required Elements” sections in Chapters 5, 6 and 10 of this technical standard. It does not include the Sizing Criteria (i.e. WQv, RRv, Cpv, Qp and Qf) in Chapters 4, 9 and 10.

PERMANENT SEEDING - Results in establishing perennial vegetation which may remain on the area for many years.

PERMEABILITY - The rate of water movement through the soil column under saturated conditions

PERMISSIBLE VELOCITY (HYDRAULICS) - The highest average velocity at which water may be carried safely in a channel or other conduit. The highest velocity that can exist through a substantial length of a conduit and not cause scour of the channel. A safe, non-eroding or allowable velocity

PH - A number denoting the common logarithm of the reciprocal of the hydrogen ion concentration. A pH of 7.0 denotes neutrality, higher values indicate alkalinity, and lower values indicate acidity.

Phosphorus Index - (Phosphorus Index) is the measure of phosphorus already present in soil. The value is determined by testing at the North Carolina Department of Agriculture and Consumer Services soil analysis laboratory in Raleigh. Values greater than 100 are considered very high. Values ranging between 50 and 100 are considered high. Values between 25 and 50 are medium; values less than 25 are low. A soil with a very high or high P-Index is less able to retain phosphorus because it is already “full.”

New York State Stormwater Management Design Manual

Glossary

PIPING - Removal of soil material through subsurface flow channels or “pipes” developed by seepage water.

PLUGS - Pieces of turf or sod, usually cut with a round tube, which can be used to propagate the turf or sod by vegetative means.

POCKET POND - A stormwater pond designed for treatment of small drainage area (< 5 acres) runoff and which has little or no baseflow available to maintain water elevations and relies on ground water to maintain a permanent pool.

POCKET WETLAND - A stormwater wetland design adapted for the treatment of runoff from small drainage areas (< 5 acres) and which has little or no baseflow available to maintain water elevations and relies on ground water to maintain a permanent pool.

POND BUFFER - The area immediately surrounding a pond which acts as filter to remove pollutants and provide infiltration of stormwater prior to reaching the pond. Provides a separation barrier to adjacent development.

POND DRAIN - A pipe or other structure used to drain a permanent pool within a specified time period.

PONDSCAPING - Landscaping around stormwater ponds which emphasizes native vegetative species to meet specific design intentions. Species are selected for up to six zones in the pond and its surrounding buffer, based on their ability to tolerate inundation and/ or soil saturation.

POROSITY - Ratio of pore volume to total solids volume.

PRETREATMENT - Techniques employed in stormwater SMPs to provide storage or filtering to help trap coarse materials before they enter the system.

PRINCIPAL SPILLWAY - The primary pipe or weir which carries baseflow and storm flow through the embankment.

REDEVELOPMENT ACTIVITY - The disturbance and reconstruction of existing impervious area, including impervious areas that were removed from a project site within five (5) years of preliminary project plan submission to the local government (i.e. site plan, subdivision, etc.).

Required Element - Features of the design that are integral to the performance of the practice and must be used in all applications.

RETENTION - The amount of precipitation on a drainage area that does not escape as runoff. It is the difference between total precipitation and total runoff.

REVERSE-SLOPE PIPE - A pipe which draws from below a permanent pool extending in a reverse angle up to the riser and which determines the water elevation of the permanent pool.

RIGHT-OF-WAY - Right of passage, as over another’s property. A route that is lawful to use. A strip of land acquired for transport or utility construction.

RIP-RAP - Broken rock, cobbles, or boulders placed on earth surfaces, such as the face of a dam or the bank of a stream, for protection against the action of water (waves); also applies to brush or pole mattresses, or brush and stone, or similar materials used for soil erosion control.

RISER - A vertical pipe or structure extending from the bottom of a pond SMP and houses the control devices (weirs/orifices) to achieve the discharge rates for specified designs.

ROUGHNESS COEFFICIENT (HYDRAULICS) - A factor in velocity and discharge formulas representing the effect of channel roughness on energy losses in flowing water. Manning’s “n” is a commonly used roughness coefficient.

RUNOFF (HYDRAULICS) - That portion of the precipitation on a drainage area that is discharged from the area in the stream channels. Types include surface runoff, ground water runoff or seepage.

New York State Stormwater Management Design Manual

Glossary

RUNOFF COEFFICIENT (RV) - A value derived from a site impervious cover value that is applied to a given rainfall volume to yield a corresponding runoff volume.

SAFE PASSAGE – Safely passing the Spillway Design Flood (SDF) and Service Spillway Design flood (SSDF) as defined in the NYSDEC “Guidelines for Design of Dams.”

SAFETY BENCH - A flat area above the permanent pool and surrounding a stormwater pond designed to provide a separation from the pond pool and adjacent slopes.

SAND - 1. (Agronomy) A soil particle between 0.05 and 2.0 millimeters in diameter. 2. A soil textural class. 3. (Engineering) According to the Unified Soil Classification System, a soil particle larger than the No. 200 sieve (0.074mm) and passing the No. 4 sieve (approximately 1/4 inch).

SEDIMENT - Solid material, both mineral and organic, that is in suspension, being transported, or has been moved from its site of origin by air, water, gravity, or ice and has come to rest on the earth’s surface either above or below sea level.

SEEPAGE - 1. Water escaping through or emerging from the ground. 2. The process by which water percolates through the soil.

SEEPAGE LENGTH - In sediment basins or ponds, the length along the pipe and around the anti-seep collars that is within the seepage zone through an embankment.

SETBACKS - The minimum distance requirements for location of a structural SMP in relation to roads, wells, septic fields, other structures.

SHEET FLOW - Water, usually storm runoff, flowing in a thin layer over the ground surface.

SIDE SLOPES (ENGINEERING) - The slope of the sides of a channel, dam or embankment. It is customary to name the horizontal distance first, as 1.5 to 1, or frequently, 1 ½: 1, meaning a horizontal distance of 1.5 feet to 1 foot vertical.

SILT - 1. (Agronomy) A soil separate consisting of particles between 0.05 and 0.002 millimeter in equivalent diameter. 2. A soil textural class. 3. (Engineering) According to the Unified Soil Classification System a fine grained soil (more than 50 percent passing the No. 200 sieve) that has a low plasticity index in relation to the liquid limit.

Site - At minimum applies to areas of disturbance. This technical standard refers to contributing areas to one design point as “site” or “project area”.

Site limitations –Site conditions that prevent the use of an infiltration technique and or infiltration of the total WQv. Typical site limitations include: seasonal high groundwater, shallow depth to bedrock, and soils with an infiltration rate less than 0.5 inches/hour. The existence of site limitations shall be confirmed and documented using actual field testing (i.e. test pits, soil borings, and infiltration test) or using information from the most current United States Department of Agriculture (USDA) Soil Survey for the County where the project is located.

SOIL TEST - Chemical analysis of soil to determine needs for fertilizers or amendments for species of plant being grown.

SPILLWAY - An open or closed channel, or both, used to convey excess water from a reservoir. It may contain gates, either manually or automatically controlled to regulate the discharge of excess water.

STABILIZATION - Providing adequate measures, vegetative and/or structural that will prevent erosion from occurring.

STAGE (HYDRAULICS) - The variable water surface or the water surface elevation above any chosen datum.

STILLING BASIN - An open structure or excavation at the foot of an outfall, conduit, chute, drop, or spillway to reduce the energy of the descending stream of water.

New York State Stormwater Management Design Manual

Glossary

STORMWATER FILTERING - Stormwater treatment methods which utilize an artificial media to filter out pollutants entrained in urban runoff.

STORMWATER PONDS - A land depression or impoundment created for the detention or retention of stormwater runoff.

STORMWATER WETLANDS - Shallow, constructed pools that capture stormwater and allow for the growth of characteristic wetland vegetation.

STREAM BUFFERS - Zones of variable width which are located along both sides of a stream and are designed to provide a protective natural area along a stream corridor.

STREAM CHANNEL PROTECTION (CP_v) - A design criteria which requires 24 hour detention of the one year postdeveloped, 24 hour storm event for the control of stream channel erosion.

STRUCTURAL SMPS - Devices which are engineered and constructed to provide temporary storage and treatment of stormwater runoff.

SUBGRADE - The soil prepared and compacted to support a structure or a pavement system.

TAILWATER - Water, in a river or channel, immediately downstream from a structure.

TECHNICAL RELEASE NO. 20 (TR-20) - A Soil Conservation Service (now NRCS) watershed hydrology computer model that is used to compute runoff volumes and route storm events through a stream valley and/or ponds.

TECHNICAL RELEASE No. 55 (TR-55) - A watershed hydrology model developed by the Soil Conservation Service (now NRCS) used to calculate runoff volumes and provide a simplified routing for storm events through ponds.

TEMPORARY SEEDING - A seeding which is made to provide temporary cover for the soil while waiting for further construction or other activity to take place.

TEN YEAR STORM (Q_{P10}) - The peak discharge rate associated with a 24 hour storm event that has a 100% chance of being equaled or exceeded in a given ten year.

TIME OF CONCENTRATION - Time required for water to flow from the most remote point of a watershed, in a hydraulic sense, to the outlet.

TOE (OF SLOPE) - Where the slope stops or levels out. Bottom of the slope.

TOE WALL - Downstream wall of a structure, usually to prevent flowing water from eroding under the structure.

TOPSOIL - Fertile or desirable soil material used to top dress roadbanks, subsoils, parent material, etc.

TOTAL IMPERVIOUS AREA - This is the total area within a watershed of all materials or structures on or above the ground surface that prevents water from infiltrating into the underlying soils. Impervious surfaces include, without limitation: paved parking lots, sidewalks, rooftops, patios, and paved, gravel and compacted-dirt surfaced roads. Gravel parking lots and/or compacted urban soils are often not included in total impervious area but may have hydrologic characteristics that closely resemble paved areas.

TOTAL SUSPENDED SOLIDS - The total amount of soil particulate matter, including both organic and inorganic material, suspended in the water column.

TRASH RACK - Grill, grate or other device at the intake of a channel, pipe, drain or spillway for the purpose of preventing oversized debris from entering the structure.

TROUT WATERS - Waters classified as (T) or (TS) by the New York State DEC.

TWO YEAR STORM (Q_{P2}) - The peak discharge rate associated with a 24 hour storm event that has a 100% chance of being equaled or exceeded in a given two year.

New York State Stormwater Management Design Manual

Glossary

ULTIMATE CONDITION - Full watershed build-out based on existing zoning.

ULTRA-URBAN - Densely developed urban areas in which little pervious surface exists.

VELOCITY HEAD - Head due to the velocity of a moving fluid, equal to the square of the mean velocity divided by twice the acceleration due to gravity (32.16 feet per second per second).

VOLUMETRIC RUNOFF COEFFICIENT (R_v) - The value that is applied to a given rainfall volume to yield a corresponding runoff volume based on the percent impervious cover in a drainage basin.

WATER QUALITY EFFICIENCY - A term that is intended to indicate the performance of the SMP by itself (not the full system including bypass). With less flow (hydrologic source control) the efficiency is likely improved.

WATER QUALITY VOLUME (WQ_v) - The storage needed to capture and treat 90% of the average annual stormwater runoff volume.

WATER SURFACE PROFILE - The longitudinal profile assumed by the surface of a stream flowing in an open channel; the hydraulic grade line.

WEDGES - Design feature in stormwater wetlands which increases flow path length to provide for extended detention and treatment of runoff.

WET SWALE - An open drainage channel or depression, explicitly designed to retain water or intercept groundwater for water quality treatment.

WETTED PERIMETER - The length of the line of intersection of the plane or the hydraulic cross-section with the wetted surface of the channel.

WING WALL - Side wall extensions of a structure used to prevent sloughing of banks or channels and to direct and confine overfall.

DEC

Division of Water

**Guidelines
for
Design of Dams**

**January 1985
Revised January 1989**

New York State Department of Environmental Conservation

George E. Pataki, *Governor*

John P. Cahill, *Commissioner*

GUIDELINES FOR
DESIGN OF DAMS

NEW YORK STATE
DEPARTMENT OF ENVIRONMENTAL CONSERVATION
DIVISION OF WATER
BUREAU OF FLOOD PROTECTION
DAM SAFETY SECTION
50 WOLF ROAD
ALBANY, NEW YORK 12233-3507

GUIDELINES FOR DESIGN OF DAMS

TABLE OF CONTENTS

SECTION	TITLE	PAGE
	Preface to the January 1989 Edition	1
1	Introduction	2
2	Definitions	3
3	Hazard Classification	5
4	Design and Construction Documents	5
5	Hydrologic Criteria	7
6	Hydraulics of Spillways	10
6A	Flashboard Policy	12
7	Outlet Works and Conduits	15
8	Geotechnical Investigations	16
9	Earth Dams	18
10	Structural Stability Criteria for Gravity Dams	21
11	Existing Dams: Rehabilitation and Modification	25
12	Cofferdams	26
13	Miscellaneous	27
14	Emergency Action Plan	27
15	Approval to Fill Reservoir	28
16	References	29
17	DEC - Regional Directory	31

PREFACE TO THE JANUARY 1988 EDITION

The January 1988 revision involves:

<u>Page</u>	<u>Item</u>
2	Introduction
4	Corrected definition for the Service Spillway Design Flood (SSDF)
6	Construction Inspection
11	Insertion of Section 6A, Flashboard Policy
14	Filter and drainage diaphragm replacing antiseep collars for pipe conduits
19	Vegetation Control
22	Insertion of Loading Condition 3A
25	Cofferdams
28	The addition of references 3, 4, 5 and 6

PREFACE TO THE JANUARY 1989 EDITION

The January 1989 revision involves:

<u>Page</u>	<u>Item</u>
7	Hydrology Investigations
7	Existing Dams - Service Spillway Design Flood Criteria

1.0 INTRODUCTION

1.1 General

The Department of Environmental Conservation receives many requests for detailed information about designs for dams requiring a permit under Article 15, Section 0503 of the Environmental Conservation law. This brochure has been developed by the department for the general guidance of design engineers.

These guidelines represent professional judgment of the Dam Safety Section's staff engineers. The guidelines convey sound engineering practices in an average situation. Where unusual conditions exist and the guidelines are not applicable, it is the duty of the design engineer to notify the department which will then consider deviation from the guidelines.

Since these are only general guidelines for small dam construction in an average situation, compliance will not necessarily result in approval of the application. The determination by the department of the acceptability of the design and adequacy of the plans and specifications will be made on a case-by-case basis. The primary responsibility of proper dam design shall continue to be that of the applicant.

In the administration of this law, the department is concerned with the protection of both the health, safety and welfare of the people and the conservation and protection of the natural resources of the State. (See Reference 1 and 2).

Water stored behind a dam represents potential energy which can create a hazard to life and property located downstream of the dam. At all times the risks associated with the storage of water must be minimized. This document deals with the engineering guidelines for the proper design of a dam. In order for a dam to safely fulfill its intended function, the dam must also be constructed, operated and maintained properly.

Supervision of construction or reconstruction of the dam by a licensed professional engineer is required to insure that the dam will be built according to the approved plans. See Article 15-0503, Item 5 of the New York State, Environmental Conservation Law (Reference 1).

For the proper operation and maintenance of a dam, see "An Owners Guidance Manual for the Inspection and Maintenance of Dams in New York State" (Reference 6).

1.2 Application

A permit is required if the dam:

- is at least 10 feet high or
- stores 1 million gallons (3.07 acre feet) or
- has a drainage area of 1 square mile.

Waste surface impoundments which are large enough to meet the above mentioned criteria shall not require an Article 15 dam permit. Hazardous waste surface impoundments will continue to be regulated by the Bureau of Hazardous Waste Technology, Division of Hazardous Substances

Regulation of the Department of Environmental Conservation, under 6NYCRR-Part 373, Hazardous Waste Management Regulation. Surface impoundments which are part of an approved waste water treatment process will be regulated within a SPDES permit issued by the Division of Water.

1.3 Application Forms

Applications, including the Supplement D-1 (hydrological, hydraulic and soils information), can be obtained from and should be submitted to the Regional Permit Administrator. The addresses of the Regional Permit Administrators are shown on page 31. Detailed information on application procedures is contained in the Uniform Procedures Regulations, Part 621.

Information on all pertinent items should be given. Construction plans and specifications should be prepared in sufficient detail to enable review engineers to determine if the proposed design and construction is in compliance with department guidelines. Thorough engineering review will be given each application. The time for this review and any additional time if revisions are necessary should be a consideration in each application.

2.0 DEFINITIONS

Appurtenant works are structures or materials built and maintained in connection with dams. These can be spillways, low-level outlet works and conduits.

Auxiliary spillway is a secondary spillway designed to operate only during large floods.

Cofferdam is a temporary structure enclosing all or part of the construction area so that construction can proceed in the dry.

Conduit is an enclosed channel used to convey flows through or under a dam.

Dam is any artificial barrier and its appurtenant works constructed for the purpose of holding water or any other fluid.

Department is the Department of Environmental Conservation (DEC).

Detention/Retention Basin is any structure that functions as a dam.

Earth Dam is made by compacting excavated earth obtained from a borrow area.

Energy Dissipator is a structure constructed in a waterway which reduces the energy of fast-flowing water.

Flood Routing is the computation which is used to evaluate the interrelated effects of the inflow hydrograph, reservoir storage and spillway discharge from the reservoir.

Freeboard is the vertical distance between the design high water level and the top of the dam.

Gravity Dam is constructed of concrete and/or masonry and/or laid-up stone that relies upon its weight for stability.

Height is the vertical dimension from the downstream toe of the dam at its lowest point to the top of the dam.

Low-Level Outlet is an opening at a low level used to drain or lower the water.

Major Size Dam is at least 25 feet high and holds at least 15 acre feet of water or is at least 6 feet high and holds at least 50 acre feet of water.

Maximum Impoundment Capacity is the volume of water held when the water surface is at the top of the dam.

Probable Maximum Flood (PMF) is the flood that can be expected from the severest combination of critical meteorologic and hydrologic conditions possible for the particular region. It is the flow resulting from the PMP.

Probable Maximum Precipitation (PMP) is the maximum amount of precipitation that can be expected over a drainage basin.

Seepage Collar is built around the outside of a pipe or conduit under an embankment dam to lengthen the seepage path along the outer surface of the conduit.

Service Spillway is the principal or first-used spillway during flood flows.

Service Spillway Design Flood(SSDF) is the flow discharged through the service spillway.

Spillway is a structure which discharges flows.

Spillway Design Flood(SDF) is the largest flow that a given project is designed to pass safely.

Toe of Dam is the junction of the downstream face of a dam and the natural ground surface, also referred to as downstream toe. For an earth dam the junction of the upstream face with the ground surface is called the upstream toe.

3.0 HAZARD CLASSIFICATION

3.1 General

The height of the dam, its maximum impoundment capacity, the physical characteristics of the dam site and the location of downstream facilities should be assessed to determine the appropriate hazard classification. Applications should include the design engineer's description of downstream conditions and his judgment of potential downstream hazards presented in the form of a letter designation and a written description.

3.2 Letter Designation

Class "A": dam failure will damage nothing more than isolated farm buildings, undeveloped lands or township or country roads.

Class "B": dam failure can damage homes, main highways, minor railroads, or interrupt use or service of relatively important public utilities.

Class "C": dam failure can cause loss of life, serious damage to homes, industrial or commercial buildings, important public utilities, main highways, and railroads.

3.3 Written Description

The written description is an elaboration of the letter designation. It includes descriptions of the effect upon human life, residences, buildings, roads and highways, utilities and other facilities if the dam should fail.

4.0 DESIGN AND CONSTRUCTION DOCUMENTS

4.1 Engineer Qualifications

The design, preparation of construction plans, estimates and specifications and supervision of the construction, reconstruction or repair of all structures must be done under the direction of a professional engineer licensed to practice in New York State. (See References 1 and 7).

4.2 Design Report

A design report, submitted with the application, should include an evaluation of the foundation conditions, the hydrologic and hydraulic design and a structural stability analysis of the dam. The report should include calculations and be sufficiently detailed to accurately define the final design and proposed work as represented on the construction plans. Any deviations from the guidelines should be fully explained.

4.3 Construction Plans

Construction plans should be sufficiently detailed for department evaluation of the safety aspects of the dam. The cover sheet should include a vicinity map showing the location of the dam. The size of the plans should be not less than 18 x 24 inches and no more than 30 x 48 inches. As-built plans of the project are required upon completion of construction.

4.4 Construction Inspection

The dam's performance will largely be controlled by the care and thoroughness exercised during its construction. Undisclosed subsurface conditions may be encountered which may materially affect the design of the dam. To ensure a safe design, the designer must be able to confirm design assumptions and revise the dam design if unanticipated conditions are encountered. Construction inspection is required in order to ensure that the construction work complies with the plans and specifications and meets standards of good workmanship. Therefore, construction inspection of a dam is required by a licensed professional engineer to monitor and evaluate conditions as they are disclosed and to observe material placement and workmanship as construction progresses.

The engineer involved in the construction of the dam work will be required to submit a periodic construction report to the Department covering the critical inspection activities for the dam's construction/reconstruction. Prior to permit issuance the applicant shall submit, for review and approval, a proposed schedule of construction inspection activities to be performed by the applicant's engineer. Upon permit issuance, the approved schedule shall be part of the required work.

4.5 Specifications

Materials specifications will be required for items incorporated in the dam project. Materials specifications including format found acceptable are those issued by the following agencies and organizations.

State: New York State Department of Transportation

Federal: COE - Corps of Engineers
SCS - Soil Conservation Service

Industry: ASTM - American Society for Testing and Materials
ACI - American Concrete Institute
AWWA - American Water Works Association
CSI - Construction Specifications Institute

5.0 HYDROLOGIC CRITERIA

5.1 Hydrologic Design Criteria

A table of hydrologic design criteria giving the spillway design flood, the service spillway design flood and minimum freeboards for various hazard classifications can be found in Table 1.

5.2 Design Flood

The National Weather Service has published data for estimating hypothetical storms ranging from the frequency-based storm to the Probable Maximum Precipitation event. For the frequency-based storms Technical Paper TP-40 (Ref 17) and TP-49 (Ref 18) will be used to determine rainfall. For the Probable Maximum Precipitation event, Hydrometeorological Report HMR-51 (Ref 16) will be used.

When using the above mentioned TP's and HMR's, the minimum storm duration will be six hours. For large drainage areas in which the time of concentration exceeds six hours, the precipitation amounts must be increased by the applicable duration adjustment.

The Soil Conservation Service (SCS) has developed Technical Release 55 (TR-55) "Urban Hydrology for Small Watersheds". TR-55 presents simplified procedures for estimating runoff and peak discharge and is an acceptable procedure for designing spillways for small watersheds. In developing TR-55 the SCS uses a storm period of 24 hours for the synthetic rainfall distribution.

Although the "rational method" ($Q=CIA$) is used for estimating design flows for storm drains and road culverts, it normally is not an acceptable method for determining peak discharge for the design of a dam spillway. The rational method should not be used for watershed areas larger than 200 acres because of its inaccuracy above that range. The greatest weakness of the "rational method" for predicting peak discharges lies in the difficulty of estimating the duration of storms that will produce peak flow. The greatest probability for error, both as to magnitude and understanding relates to the term "intensity" or "rate of rainfall". Although the units are inches per hour, the term does not mean the total inches of rain falling in a period of one hour. "Intensity" should be related to the time of concentration. "Intensities" would be higher for storms of short duration and would be lower for storms of longer duration.

Table I indicates that the appropriate Spillway Design Flood will be a percentage of the 100 year flood or the PMF. Therefore, in order to correctly determine the peak flow, the rainfall values used will be for the 100 year flood or the PMF and the appropriate peak discharge will be computed. After the peak discharge has been found, this value will then be multiplied by the appropriate percentages. For example a small dam in the Class "B" hazard category will have the discharge based on the

rainfall from a 100 year flood and this discharge will then be multiplied by 2.25 to obtain the peak discharge. The percentages should be applied to the discharge values in the final step of the calculations. It is incorrect to apply the percentages to the rainfall values.

5.3 Existing Dams - Design Flood

Existing dams that are being rehabilitated should have adequate spillway capacity to pass the following floods without overtopping:

<u>Hazard Classification</u>	<u>Spillway Design Flood (SDF)</u>
A	100 year
B	150% of 100 year
C	50% of PMF

The Service Spillway Design Flood (SSDF) for existing dams is the same as shown for the new dams on Table 1.

TABLE 1 - NEW DAMS

HYDROLOGIC DESIGN CRITERIA TABLE

HAZARD CLASSIFICATION	SIZE DAM	SPILLWAY DESIGN FLOOD (SDF)	SERVICE SPILLWAY DESIGN FLOOD (SSDF)	MINIMUM FREEBOARD (FT.)
"A"	*SMALL	100 year	5 year	1
"A"	*LARGE	150% of 100 yr.	10 year	2
"B"	SMALL	225% of 100 yr.	25 year	1
"B"	LARGE	40% of PMF	50 year	2
"C"	SMALL	50% of PMF	25 year	1
"C"	LARGE	PMF	100 year	2

*SMALL

Height of dam less than 40 feet. Storage at normal water surface less than 1000 acre feet.

*LARGE

Height at dam equal to or greater than 40 feet. Storage at normal water surface equal to or greater than 1000 acre feet.

NOTE:

Size classification will be determined by either storage or height, whichever gives the larger size category.

6.0 HYDRAULICS OF SPILLWAYS

6.1 Spillways

Spillways protect the dam from overtopping. Consideration must be given to dams and reservoirs upstream of the dam in question when designing the spillway. A dam should be provided with either a single spillway or a service spillway-auxiliary spillway combination.

6.2 Single Spillway

For a single spillway, the structure should have the capacity and the durability to handle sustained flows as well as extreme floods and be non-erodible and of a permanent-type construction. Free overall spillways, ogee spillways, drop inlet or morning glory spillways, and chute spillways are common types. An earth or grass-lined spillway is not durable under sustained flow and should not be used as a single spillway.

6.3 Criteria for a single spillway are as follows:

- 6.3.1 Sufficient spillway capacity should be provided to safely pass the spillway design flood with flood routing through the reservoir. (See Table 1 for spillway design flood).
 - 6.3.2 Assuming no inflow, the spillway should have sufficient discharge capacity to evacuate 75% of the storage between the maximum design high water and the spillway crest within 48 hours.
 - 6.3.3 The spillway will have an energy dissipater at its terminus.
 - 6.3.4 A drop inlet or morning glory spillway, as a single spillway, is only acceptable on a Hazard Class "A" structure with a drainage area of less than 50 acres. In this case, sufficient storage capacity should be provided between the spillway crest and top of dam to contain 150% of the entire spillway design flood runoff volume.
- 6.4 Service Spillway - Auxiliary Spillway Combination:
In the case of the service spillway - auxiliary spillway combination, the service spillway discharges normal flows and the more frequent floods, while the auxiliary spillway functions only during extreme floods.

Service spillways must be durable under conditions of sustained flows; whereas auxiliary spillways do not. Service spillways should have sufficient capacity to pass frequent floods and thus reduce the frequency of use of the auxiliary spillway. The service spillway usually does not have sufficient capacity to pass the entire spillway design flood. Drop inlet or morning glory spillways are common types of service spillways. This type of structure will consist of a vertical inlet riser connected to a service spillway conduit with an energy

dissipator at the outlet. An auxiliary spillway is capable of handling high but short duration flows. It may be an excavated grass-lined channel if the designer is able to limit velocities to the non-erodible range for grass. It cannot carry prolonged flows because of eventual deterioration of the grass linings. For spillways which will be required to discharge flows at a high velocity, a more permanent type of material such as concrete will be required. An auxiliary spillway may be located adjacent to a dam abutment or anywhere around the rim of the reservoir. It should be located sufficiently apart from the dam to prevent erosion of any embankment materials. A spillway over the dam is not acceptable. It may either discharge back into the natural watercourse below the dam, or so long as a flood hazard is not created, into a watercourse within an adjacent drainage basin.

- 6.5 Criteria for an auxiliary spillway-service spillway combination are as follows:
 - 6.5.1 Sufficient service spillway capacity should be provided to safely pass the service spillway design flood with flood routing through the reservoir. (See Table 1 for service spillway design flood).
 - 6.5.2 The service spillway normally should be provided with an energy dissipater at its outlet end.
 - 6.5.3 The auxiliary spillway crest must be placed at or above the service spillway design high water, and not less than 1 foot above the service spillway crest.
 - 6.5.4 The auxiliary spillway-service spillway combination must provide sufficient discharge capacity to safely pass the spillway design flood with flood routing through the reservoir (See Table 1 for spillway design flood).
 - 6.5.5 Assuming no inflow, the auxiliary spillway-service spillway combination should have sufficient capacity to evacuate the storage between the maximum design high water and the auxiliary spillway crest within 12 hours.
 - 6.5.6 Assuming no inflow, the service spillway should have sufficient capacity to evacuate 75% of the storage between the auxiliary spillway crest and the service spillway crest within 7 days.
 - 6.5.7 Auxiliary spillways shall not be placed on fill.
 - 6.5.8 Velocities in auxiliary spillways should not exceed the maximum permissible velocities (non-erodible velocities) of the spillway materials.

6.5.9 If an auxiliary spillway is located near an embankment, it should be located so as not to endanger the stability of the embankment. The following criteria will help guard against damage to the embankment:

a. Discharge leaving the exit channel should be directed away from the embankment and should be returned to a natural watercourse far enough downstream as to have no erosive effect on the embankment toe.

b. The spillway exit channel, from the spillway crest to a section beyond the downstream toe of dam, should be uniform in cross-section, contain no bends, and be longitudinally perpendicular to the spillway crest. Curvature may be introduced below the toe of dam if it is certain that the flowing water will not impinge on the toe of dam.

6.0 A FLASHBOARD POLICY

Background

Flashboards are used to raise the water surface of an impoundment. However, the installation of flashboards along the crest of a spillway may permanently reduce the size of the spillway opening. Our records indicate that in some instances the reduction of spillway capacity with the installation of flashboards has resulted in overtopping and subsequent dam failure. Two examples are the Tillson Lake Dam (#1942420) in Ulster County and the Lake Algonquin Dam (#171-2700) in Hamilton County.

In 1939 flashboards were placed across the spillway of the 40 foot high Tillson Lake Dam in such a manner as to greatly reduce the spillway opening. Storm flow caused dam overtopping which eroded the earth slope in front of the 100 foot wide, 30 foot high concrete core wall. Failure of the core wall resulted in a tremendous amount of erosion to farm land, loss of farm machinery, chickens, several local bridges and basement flooding. The dam was rebuilt and failed in 1955 because flashboards were again in place and did not fail during storm flow.

In 1949 the Lake Algonquin Dam failed because flashboards were not removed for the winter. A January storm caused overtopping and subsequent dam failure at the right abutment. The dam failure resulted in the loss of a home, several farm buildings and a road.

When wood flashboards are installed properly they will be

supported by steel pins. These steel pins will be designed to fail when the depth of flow over the top of the flashboards reaches a certain level. Critical to the design of the flashboard system are the diameter of the steel pin, the ultimate strength of the steel and the spacing of the pins. In very few cases is the Consulting Engineer or Contractor who designed the flashboards able to provide sufficient quality control to ascertain that the as-built condition is similar to the design proposal.

Many field maintenance personnel do not understand the need for flashboards to fail when the depth of flow over the flashboards reaches a certain level. Therefore, there is a tendency to insert the flashboards in such a manner so that they will never fail, thus permanently reducing spillway capacity and increasing the possibility of dam failure by overtopping. This is what nearly happened at the Gore Mountain Dam at North Creek. During the period of 1977-1980 DEC operations personnel installed wide flange beams to support the wood flashboards. The approved design for the flashboard supports were one inch diameter steel pins. However, operations personnel decided they would have less maintenance problems if they permanently secured the wood flashboards between the six inch wide flange beams. Under this support the flashboards would never fail.

Around February 15, 1981 a sudden thaw and rain caused the water level at Gore Mountain Dam to rise within eight inches of the top of dam. This level was about two feet, four inches over the top of the flashboards. The extra sturdy wide flange beam support system precluded any chance of flashboard failure. Fortunately this abnormally high level was reported to the DEC by a local resident while he was snowmobiling. During the fall of 1981, DEC revised the flashboard support system so that the flashboards were properly supported by one inch diameter steel pins and the steel pins would fail in bending when the depth of flow over the top of the flashboards reached one foot.

For the foregoing reasons the Dam Safety Section has developed the following policy regarding the installation of flashboards on dams.

New Dams

Flashboards shall not be installed on any new dams. The dam owner or hydroelectric developer shall determine the normal pool elevation for the proposed impoundment and provide a permanently fixed spillway crest at the selected elevation. If pool elevation fluctuations are desired, they should be achieved by means of adequately sized gates, drains, siphons or other acceptable methods.

Existing Dams

A permanently fixed spillway crest is the preferred method of establishing normal pool elevation.

The installation or continued use of flashboards on existing dams will be considered on a case by case basis. Flashboards on existing dams will only be acceptable if the dam is able to satisfy the hydraulic and structural stability criteria contained in the Guidelines for Design of Dams. If the flashboards are designed to fail in order to satisfy either criterion, detailed failure calculations must be submitted for Department review and approval. The maximum pool elevation the flashboards are designed to fail at shall be the lower of:

1. Two times the height of the flashboards measured from the bottom of the flashboards, or
2. Two times the freeboard specified in Table 1 of these Guidelines, for a dam of the pertinent size and hazard classification, measured downward from the top of dam.

The maximum pool elevation that would be reached under Spillway Design Flood conditions, without the flashboards failing, shall also be determined.

Flashboards shall be installed, operated and maintained as intended in their design and in accordance with the terms and/or conditions of any permits or approvals. The approved flashboard configuration (pin spacing, pin size, board height, board size, etc.) shall not be modified without prior Department approval.

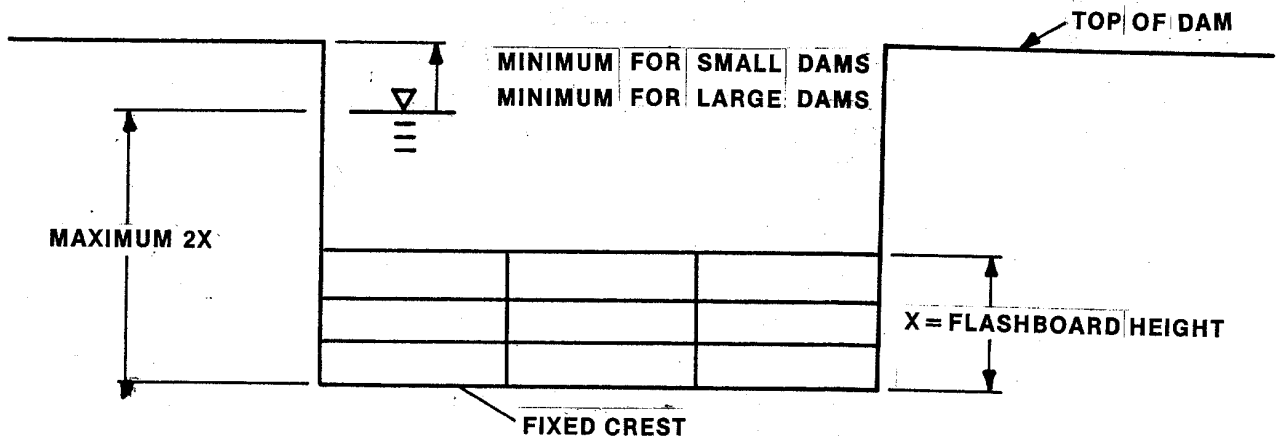

7.0 OUTLET WORKS AND CONDUITS

7.1 Outlet Works

A low-level outlet conduit or drain is required for emptying or lowering the water in case of emergency; for inspection and maintenance of the dam, reservoir, and appurtenances; and for releasing waters to meet downstream water requirements. The outlet conduit may be an independent pipe or it may be connected to the service spillway conduit. The low level drain is required to have sufficient capacity to discharge 90% of the storage below the lowest spillway crest within 14 days, assuming no inflow into the reservoir.

7.2 Control

Outlet conduits shall have an upstream control device (gate or valve) capable of controlling the discharge for all ranges of flow.

7.3 Conduits

Only two types of conduits are permitted on Hazard Class "B" and "C" structures; precast reinforced concrete pipe and cast-in-place reinforced concrete.

On Hazard Class "A" structures, welded steel pipe or corrugated metal pipe may be used providing the depth of fill over the pipe does not exceed 15 feet and the pipe diameter does not exceed 24 inches.

All outlet conduits shall be designed for internal pressure equal to the full reservoir head and for the superimposed embankment loads, acting separately.

The minimum size diameter conduit used as the barrel of a drop inlet service spillway shall be 12 inches.

The joints of all pipe conduits shall be made watertight.

Any pipe or conduit passing through an embankment shall have features constructed into the embankment whereby seepage occurring along the pipe or conduit is collected and safely conveyed to the downstream toe of the embankment. This can be accomplished by using a properly designed and constructed filter and drainage diaphragm. The filter and drainage diaphragm will be required unless it can be shown that antiseep collars will adequately serve the purpose.

Antiseep collars will not be permitted for dams with a height in excess of 20 feet. If antiseep collars are used in lieu of a

drainage diaphragm, they shall have a watertight connection to the pipe. Collar material shall be compatible with pipe materials. The antiseep collars shall increase the seepage path along the pipe by at least 15%.

A means of dissipating energy shall be provided at the outlet end of all conduits 12 inches or more in diameter. If a plunge pool is used, the conduit should be cantilevered 8 feet over a concrete, steel or treated timber support located near or at the downstream toe of the embankment. The plunge pool should be riprap-lined if a conduit 18 inches or more in diameter is used. The foregoing may apply to smaller pipes if the embankment's downstream slope is steep and the soil erodible.

8.0 GEOTECHNICAL INVESTIGATION

8.1 Foundations

8.1.1 Subsurface explorations (drill holes, test pits and/or auger holes) should be located along the centerline of the dam, at the proposed service and auxiliary spillway locations, and in other critical areas. The depth of the subsurface explorations should be sufficient to locate and determine the extent and properties of all soil and rock strata that could affect the performance of the dam, the reservoir and appurtenant structures. Referring to information such as geologic bulletins, soil survey maps, groundwater resources bulletins, etc., may aid the designer in determining the scope of the exploration program needed and interpreting the results of the program. For even the smallest low hazard dams, at least three explorations should be made along the centerline of the dam, one in the deepest part of the depression across which the dam will be built and one on each side. At least one exploration should be made at the proposed auxiliary spillway location. For small low-hazard dams, to be built on a foundation known from the geology of the area to be essentially incompressible and impervious to a great depth, the minimum depth of explorations should be 5 feet unless bedrock is encountered above this depth. In other cases the minimum depth of explorations should be 10 feet, with one or more borings extending to a depth equal to the proposed height of the dam. If it is proposed to excavate in the reservoir area, the possibility of exposing pervious foundation layers should be investigated by explorations or a review of the geology of the area. If rock is encountered in explorations, acceptable procedures, such as coring, test pits, or geologic information, should be used to verify whether or not it is bedrock.

8.1.2 Sufficient subsurface explorations should be made to verify the suitability of encountered rock for use as a foundation

and/or construction material. Testing of the rock materials shall ascertain its strength, compressibility, and resistance to degradation, and its ability to safely withstand the loads expected to be imposed upon it by the proposed project.

- 8.1.3 Soils encountered in explorations should be described accurately and preferably classified in accordance with the Unified Soil Classification System.
- 8.1.4 For Hazard Class "C" dams, appropriate field and/or laboratory tests should be performed in order to aid in evaluating the strength, compressibility, permeability, and erosion resistance of the foundation soils. Also, appropriate laboratory tests should be performed on samples of the proposed embankment materials in order to ascertain their suitability for use in the dam. Field and/or laboratory tests may be required also for dams of lower hazard classification in the case of critical foundation strength or permeability conditions.
- 8.1.5 Stability of the foundation under all operating conditions should be evaluated.
- 8.1.6 Settlement of the dam and appurtenant works should be evaluated and provisions made in the design to counteract the effects of any anticipated settlements.
- 8.1.7 Whenever feasible, seepage under the dam should be controlled by means of a complete cutoff trench extending through all pervious foundation soils into a relatively impervious soil layer. If the dam is to be built on an impervious foundation, the cutoff or key trench should be excavated to a depth of at least 3 feet into the foundation soils and backfilled with compacted embankment material. Where the final depth of cutoff cannot be established with certainty during design, a note should appear on the plans stating that the final depth of the cutoff trench will be determined by the engineer during the time of construction. Backfilling of the cutoff or key trench should be performed in the dry, unless special construction procedures are used. The bottom width of the trench should be at least 8 feet and should be increased in the case of dams more than 20 feet high. The widths of complete cutoffs may be made considerably less if the cutoff is extended vertically a minimum distance of 4 feet into impervious material. In the case of a cutoff or key trench extending to bedrock, the trench does not have to extend into rock. However, all shattered and disintegrated rock should be removed and surface fissures filled with cement grout. The need for pressure grouting rock foundations should be evaluated and, if necessary, adequately provided for.

8.2 Borrow Sources for Embankment Materials

Sufficient subsurface explorations should be made in borrow areas to verify the suitability and availability of an adequate supply of borrow materials. Logs of explorations should be included for review with the plans and specifications. Exposure of pervious soils and fissured rock below normal water surface of the proposed pond, at borrow areas located in or connected to the reservoir area, should be avoided.

If pervious soils or fissured rock conditions are encountered during borrow operations these exposed areas should be sealed with a sufficient thickness of compacted impervious material. In no case should this seal be less than two feet thick and consideration should be given to utilizing a greater thickness where site conditions and hazard classifications dictate.

Borrow areas should be located with due consideration to the future safety of the dam and should be shown on the plans. In general, no borrow should be taken within a distance measured from the upstream toe of the dam equal to twice the height of the dam or 25 feet, whichever is greater.

9.0 EARTH DAMS

9.1 Geometry

9.1.1 The downstream slope of earth dams without seepage control measures should be no steeper than 1 vertical on 3 horizontal. If seepage control measures are provided, the downstream slope should be no steeper than 1 vertical on 2 horizontal.

9.1.2 The upstream slope of earth dams should be no steeper than 1 vertical on 3 horizontal.

9.1.3 The side slopes of homogenous earth dams may have to be made flatter based on the results of design analyses or if the embankment material consists of fine grained plastic soils such as CL, MH or CH soils as described by the Unified Soil Classification System.

9.1.4 The minimum allowable top width (W) of the embankment shall be the greater dimension of 10 feet or W, as calculated by the following formula:

$W = 0.2H + 7$; where H is the height of the embankment (in feet)

9.1.5 The top of the dam should be sloped to promote drainage and minimize surface infiltrations and should be cambered so that the design freeboard is maintained after post-construction settlement takes place.

9.2 Slope Stability

Where warranted and especially for new Hazard Class "C" dams, the department may require that slope stability analyses be provided for review. The method of analyses and appropriate factors of safety for the applicable loading conditions shall be as indicated by U. S. Army Corps of Engineers publications (latest edition) (Ref. 11).

Earth dams, in general, should have seepage control measures, such as interior drainage trenches, downstream pervious zones, or drainage blankets in order to keep the line of seepage from emerging on the downstream slope, and to control foundation seepage. Hazard Class "A" dams less than 20 feet in height and Hazard Class "B" dams less than 10 feet in height, if constructed on and of erosion-resistant materials, do not require special measures to control seepage.

In zoned embankments, consideration should be given to the relative permeability and gradation of embankment materials. No particle greater in size than six inches in maximum dimension should be allowed to be placed in the impervious zone of the dam.

9.3 Compaction Control and Specifications

Before compaction begins, the embankment material should be spread in lifts or layers having a thickness appropriate to the type of compaction equipment used. The maximum permissible layer thickness should be specified in the plans or specifications.

Specifications should require that the ground surface under the proposed dam be stripped of all vegetation, organic and otherwise objectionable materials. After stripping, the earth foundation should be moistened, if dry, and be compacted before placement of the first layer of embankment material. Inclusion of vegetation, organic material, or frozen soil in the embankment, as well as placing of embankment material on a frozen surface is prohibited and should be so stated in the specifications.

For all dams, compaction shall be accomplished by appropriate equipment designed specifically for compaction. The type of compaction equipment should be specified in the plans or specifications.

The degree of compaction should be specified either as a minimum number of complete coverages of each layer by the compaction equipment or, in the case of higher or more critical dams, based on standard ASTM test methods.

When the degree of compaction is specified as a number of complete coverages or passes, the final number of passes required shall be determined by the engineer during construction.

In order to insure that the embankment material is compacted at an appropriate moisture content, a method of moisture content control should be specified. For Hazard Class "A" dams less than 20 feet high, the moisture content may be controlled visually by a qualified inspector. Hand tamping should be permitted only in bedding pipes passing through the dam. All other compaction adjacent to structures should be accomplished by means of manually directed power tampers.

Backfill around conduits should be placed in layers not thicker than 4 inches before compaction with particle size limited to 3 inches in greatest dimension and compacted to a density equal to that of the adjacent portion of the dam embankment regardless of compaction equipment used.

Care should be exercised in placing and compacting fill adjacent to structures to allow the structures to assume the loads from the fill gradually and uniformly. Fill adjacent to structures shall be increased at approximately the same rate on all sides of the structures.

The engineer in charge of construction is required to provide thorough and continuous testing to insure that the specified density is achieved.

9.4 VEGETATION CONTROL - TREES AND BRUSH

9.4.1 Trees and Brush

Trees and brush are not permitted on earth dams because:

- a. Extensive root systems can provide seepage paths for water.
- b. Trees that blow down or fall over can leave large holes in the embankment surface that will weaken the embankment and can lead to increased erosion.

- c. Brush obscures the surface limiting visual inspection, provides a haven for burrowing animals and retards growth for grass vegetation.

Stumps of cut trees should be removed so grass vegetation can be established and the surface mowed. Stumps should be removed either by pulling or with machines that grind them down. All woody material should be removed to about 6 inches below the ground surface. The cavity should be filled with well compacted soil and grass vegetation established.

9.4.2 Grass Vegetation

Grass vegetation is an effective and inexpensive way to prevent erosion of embankment surfaces. It also enhances the appearance of the dam and provides a surface that can be easily inspected.

10.0 STRUCTURAL STABILITY CRITERIA FOR GRAVITY DAMS

10.1 Application

These guidelines are to be used for the structural stability analysis of concrete and/or masonry sections which form the spillway or non-overflow section of gravity dams.

These guidelines are based on the "Gravity Method of Stress and Stability Analysis" as indicated in Reference 13.

If the gravity dam has keyed or grouted transverse contraction joints, then the "Trial-Load Twist Method of Analysis" (Reference 13) may be used for the stability analysis.

Elastic techniques, such as the finite element method, may be used to investigate areas of maximum stress in the gravity dam or the foundation. However, the finite element method will only be permitted as a supplement to the Gravity Method. The Gravity Method will be required for the investigation of sliding and overturning of the structure.

10.2 Non-Gravity Dams

For non-gravity structures such as arch dams, the designer is required to present calculations based on appropriate elastic techniques as approved by the Dam Safety Section.

10.3 Loads

Loads to be considered in stability analyses are those due to: external water pressure, internal water pressure (pore pressure or uplift) in the dam and foundation, silt pressure, ice pressure, earthquake, weight of the structure.

10.4 Uplift

Hydrostatic uplift pressure from reservoir water and tailwater act on the dam. The distribution of pressure through a section of the dam is assumed to vary linearly from full hydrostatic head at the upstream face of the dam to tailwater pressure at the downstream face or zero if there is no tailwater. Reduction in the uplift pressures might be allowed in the following instances:

10.4.1 When foundation drains are in place. The efficiency of the drains will have to be verified through piezometer readings.

10.4.2 When a detailed flow net analysis has been performed and indicates that a reduction in uplift pressures is appropriate. Any reduction of pressure of more than 20% must be verified by borings and piezometer readings.

10.4.3 When a sufficient number of borings have been progressed and piezometer readings support the fact that actual uplift pressures are less than the theoretical uplift pressures.

10.5 Loading Conditions

Loading Conditions to be analyzed.

Case 1 - Normal loading condition; water surface at normal reservoir level.

Case 2 - Normal loading condition; water surface at normal reservoir level plus an ice load of 5,000 pounds per linear foot, where ice load is applicable. Dams located in more northerly climates, may require a greater ice load.

Case 3 - Design loading condition; water surface at spillway design flood level.

Case 3A- Maximum hydrostatic loading condition; maximum differential head between headwater and tailwater levels as determined by storms smaller in magnitude than the spillway design flood. This loading condition will only be considered when the is submerged under Case 3 loading condition.

Case 4 - Seismic loading condition; water surface at normal reservoir level plus a seismic coefficient applicable to the location.

10.6 Stability Analysis for New Dams

10.6.1 Field Investigation

Subsurface investigations should be conducted for new dams. Borings should be made along the axis of the dam to determine the depth to bedrock as well as the character of the rock and soils under the dam. The number and depth of holes required should be determined by the design engineer based on the complexity of geological conditions. The depth of holes should be at least equal to the height of the dam. Soil samples and rock cores should be collected to permit laboratory testing. The values of cohesion and internal friction of the foundation material should be determined by laboratory testing.

On proposed sites where the foundation bedrock is exposed, the requirements for borings may be waived in some cases. An engineering geologist's professional opinion of the rock quality and the acceptability of the design assumptions will be required in those cases.

10.6.2 Overturning

The resultant force from an overturning analysis should be in the middle third of the base for all loading conditions, except for the seismic analysis (Case 4), where the resultant shall fall within the limits of the base.

10.6.3 Cracking

The resultant force falling outside the middle third of the base and its resulting tension cracks will not be accepted in the design of new dams, except for the seismic loading condition (Case 4).

10.6.4 Sliding

Sliding safety factors may be computed using the Shear-Friction method of analysis when shear values are based on either the results of laboratory testing or an engineering geologist's professional opinion. When the Shear-Friction method is used, the structure should have a minimum safety factor of 2.0 for all loading conditions except for Case 4 (seismic loading) where the minimum acceptable sliding safety factor shall be 1.5.

Designs which are not based on laboratory testing or an engineering geologist's professional opinion must be analyzed using the Friction Factor of Safety. This analysis assumes that the value of shear or cohesion is zero. The minimum safety factor using this method should be 1.5 for all loading conditions except Case 4 where the minimum safety factor shall be 1.25.

10.7 Stability Analysis for Existing Dams

10.7.1 Field Investigations

Subsurface investigations should normally be conducted as part of a detailed structural stability investigation for an existing dam and should provide information regarding the materials of the dam and its foundation. The number and depth of holes required should be determined by the engineer based on the complexity of the composition of the dam and foundation. Samples should be collected and tested to determine the material properties. The program should also measure the uplift pressures at several locations along the base of the dam.

In cases where no subsurface investigations are conducted conservative assumptions regarding material properties and uplift pressures will be required.

10.7.2 Overturning

The resultant force from an overturning analysis should be in the middle third of the base for normal loading conditions (Case 1) and within the middle half of the base for the ice loading condition (Case 2) and the spillway design flood loading condition (Case 3). For the seismic loading condition (Case 4), the resultant force should fall within the limits of the base.

10.7.3 Cracking

If the overturning analysis indicates that the resultant force is outside the middle third, then tension exists at the heel of the dam which may result in the cracking of the concrete. For existing dams cracking will be permitted for all loading conditions except the normal loading condition (Case 1). If the criteria specified above in Overturning for the location of the resultant force are not satisfied, further study and/or remedial work will be required. The Bureau of Reclamation's Cracked Section Method of analysis is acceptable for investigating the stability of the dam for the above mentioned loading conditions. When the Cracked Section Method of analysis is used, the criteria for the minimum sliding factor of safety will have to be satisfied.

10.7.4 Sliding

Sliding safety factors may be computed using the Shear-Friction method of analysis when shear values are based on the results of laboratory testing of samples from subsurface investigations. When the Shear-Friction method is used, the structure should have a minimum safety factor of 2.0 for Case 1 and Case 2; a value of 1.5 for Case 3 and a value of 1.25 for Case 4.

If no subsurface explorations are performed, the sliding safety factors must be computed using the Friction Factor of Safety. The minimum safety factor using this method should be 1.5 for Case 1; a value of 1.25 for Case 2 and Case 3; and a value of 1.0 for Case 4.

11.0 EXISTING DAMS: REHABILITATION AND MODIFICATION

Additional data should be submitted for dam rehabilitations or dam modifications, including a report by a professional engineer describing the performance and maintenance history of the existing dam. In addition, all data regarding construction, such as existing subsurface explorations, construction materials used for the dam, and plans and specifications should be submitted. If this information is not available, the engineer should inspect and evaluate the structure as to its condition, performance, maintenance history and other information regarding foundation soils and existing conditions.

The engineer should also assess the safety and adequacy of the existing structure against those criteria for spillway capacity and structural stability, indicated in the appropriate sections of these guidelines.

Where a new embankment is to be constructed against an existing dam embankment, the existing slope shall be benched as the new fill is spread and compacted in layers as described in the plans and specifications. This benching is done to provide an interlock between the existing and new embankments. Benching shall not be done in the upstream-downstream direction.

All topsoil and sod shall be stripped from the surface of the existing embankment before placing new material within the area of reconstruction.

Remove or seal all existing drainage structures which are not to be operative in the proposed design, in order to prevent a plane of seepage from developing through the dam.

12.0 COFFERDAMS

A cofferdam in most cases is a temporary structure enclosing all or part of the construction area. The purpose of the cofferdam is to provide protection so that construction can proceed in the dry.

12.1 When using a cofferdam the following criteria must be met:

12.1.1 Flood Plain Management

A hydraulic analysis must be performed to determine the backwater effect of the cofferdam. A range of flood discharges up to and including the 100 year return frequency flood shall be evaluated to determine the potential flood damages to lands and improvements upstream of the cofferdam not owned or otherwise controlled by the applicant. The analysis shall focus on determining if the project meets the flood plain management criteria of 6NYCRR-Part 500, if applicable, or regulations adopted by the local jurisdiction for participation in the National Flood Insurance Program.

12.1.2 Dam Safety

The applicant will have to demonstrate that cofferdam failure will not adversely impact lives and property. The evaluation will focus on the potential for flooding, loss of life and damage to properties downstream of the cofferdam not owned or otherwise controlled by the applicant.

If cofferdam failure could adversely impact properties downstream of the cofferdam, not controlled by the applicant, or if the cofferdam failure could adversely impact lives, then more specific information regarding the geotechnical, structural and hydraulic aspects of the cofferdam design will be required. The determination by the department of the acceptability of the cofferdam design will be made on a case-by-case basis.

13.0 MISCELLANEOUS

The earth embankment, earth spillways, and all disturbed earth adjacent to the embankment or other appurtenances should be seeded, except where riprap or other slope protective materials are specified.

Where destructive wave action is expected, the upstream slope of the embankment should be protected with rock riprap or other suitable material for effective erosion control.

A trash rack designed to prevent debris from entering and obstructing flow in the conduit should be provided on the vertical riser for any drop inlet spillway.

An anti-vortex device is required on the vertical riser for any drop inlet spillway with riser diameter greater than 12 inches.

Instrumentation

1. Piezometers - All earth dams 40 feet high or higher shall have at least two piezometers on the downstream slope of the embankment to measure saturation levels and hydrostatic pressures. All concrete dams 40 feet or higher should have at least two piezometers along the crest of the dam.

2. Weirs - on all dams with toe drains, weirs are required at the downstream end of the drain. The weirs measure the amount of seepage water through the embankment. Measurements of the seepage should be documented and correlated with the reservoir surface elevation. See Reference 6, pages 55-56.

14.0 EMERGENCY ACTION PLAN

An emergency action plan (EAP) should be developed by the owner of a high hazard dam (Class "C").

A copy of this EAP is to be provided to the Dam Safety Section of the department during the initial permit review period for new dams and for existing dams, if a copy of the EAP has not been previously submitted. See Reference 6, pages 69-73.

15.0 APPROVAL TO FILL RESERVOIR OF A NEW DAM

Before any water can be impounded by the dam, the dam owner shall adhere to the following:

15.1 For all Hazard Class "C" and [major size] Hazard Class "B" dams.

Within two weeks after completion of dam construction the permittee shall notify the Regional Permit Administrator in writing by certified mail of its completion and shall include a notarized statement from the owner's engineer that the project has been completely constructed under his care and supervision in accordance with plans and specifications as approved by the department. Any changes in the construction of the dam from the approved plans will be reflected in the "As-Built" plans.

The department will inspect the completed dam with the owner's engineer. During the inspection, the owner's engineer will submit "As Built" drawings and other construction records for review, such as foundation data and geological features, properties of embankment and foundation materials, concrete properties and construction history. Upon review of the data and the determination of the adequacy of the structure the "Approval to Fill" letter will be issued, permitting the owner to store water.

15.2 For all Hazard Class "A" and [Below Major Size] Hazard Class "B" dams.

Within two weeks after completion of dam construction the permittee shall notify the Regional Permit Administrator in writing by certified mail of its completion and shall include a notarized statement from the owner's engineer stating that the project has been completely constructed under his care and supervision in accordance with plans and specifications as approved by the department. Any changes in the construction of the dam from the approved plans will be reflected in the "As-Built" plans that will be submitted to the Department.

No water shall be impounded for at least 15 days subsequent to the notification to the Regional Permit Administrator.

REFERENCES

1. New York State Environmental Conservation Law "Article 15-0503".
2. New York Code of Rules and Regulations (6NYCRR) "Part 621 - Uniform Procedures".
3. New York Code of Rules and Regulations (6NYCRR) "Part 673 - Dam Safety Regulations"
4. New York Code of Rules and Regulations (6NYCRR) "Part 500 - Flood Plain Development Permits"
5. New York Code of Rules and Regulations (6NYCRR) "Part 373 - Hazardous Waste Management"
6. An Owners Guidance Manual For the Inspection and Maintenance of Dams in New York State.
7. New York State Education Law "Article 55".
8. Soil Conservation Service; U. S. Department of Agriculture SCS National Engineering Handbook; August, 1972 "Section 4 -Hydrology
Corps of Engineers; U. S. Army
9. Hydrologic Engineering Center
"HEC-1 Flood Hydrograph Package"; 1981
10. ETL 1110-2-256; June 1981
"Sliding Stability for Concrete Structures".
11. EM 1110-2-1902; April 1970
"Stability of Earth and Rock-Fill Dams"
Bureau of Reclamation; U. S. Department of the Interior
12. "Design of Small Dams", 1977 Revised Reprint
13. "Design of Gravity Dams", 1976
14. "Earth Manual"

National Oceanic and Atmospheric Administration National Weather
Service; U.S. Department of Commerce

15. Hydrometeorological Report 33; April 1956 "Seasonal Variation of the Probable Maximum Precipitation East of the 105th Meridian for Areas from 10 to 1000 Square Miles and Durations of 6, 12, 24 and 48 Hours"
16. Hydrometeorological Report 51; June 1978 "Probable Maximum Precipitation Estimates, United States East of the 105th Meridian"
17. Technical Paper 40; May 1961 "Rainfall Frequency Atlas of the United States for Durations from 30 Minutes to 24 Hours and Return Periods from 1 to 100 Years"
18. Technical Paper 49; 1964 "Two-to-Ten-Day Precipitation for Return Periods of 2 to 100 Years in the Contiguous United States"

New York State
 Department of
 Environmental Conservation
 Division of Environmental Permits

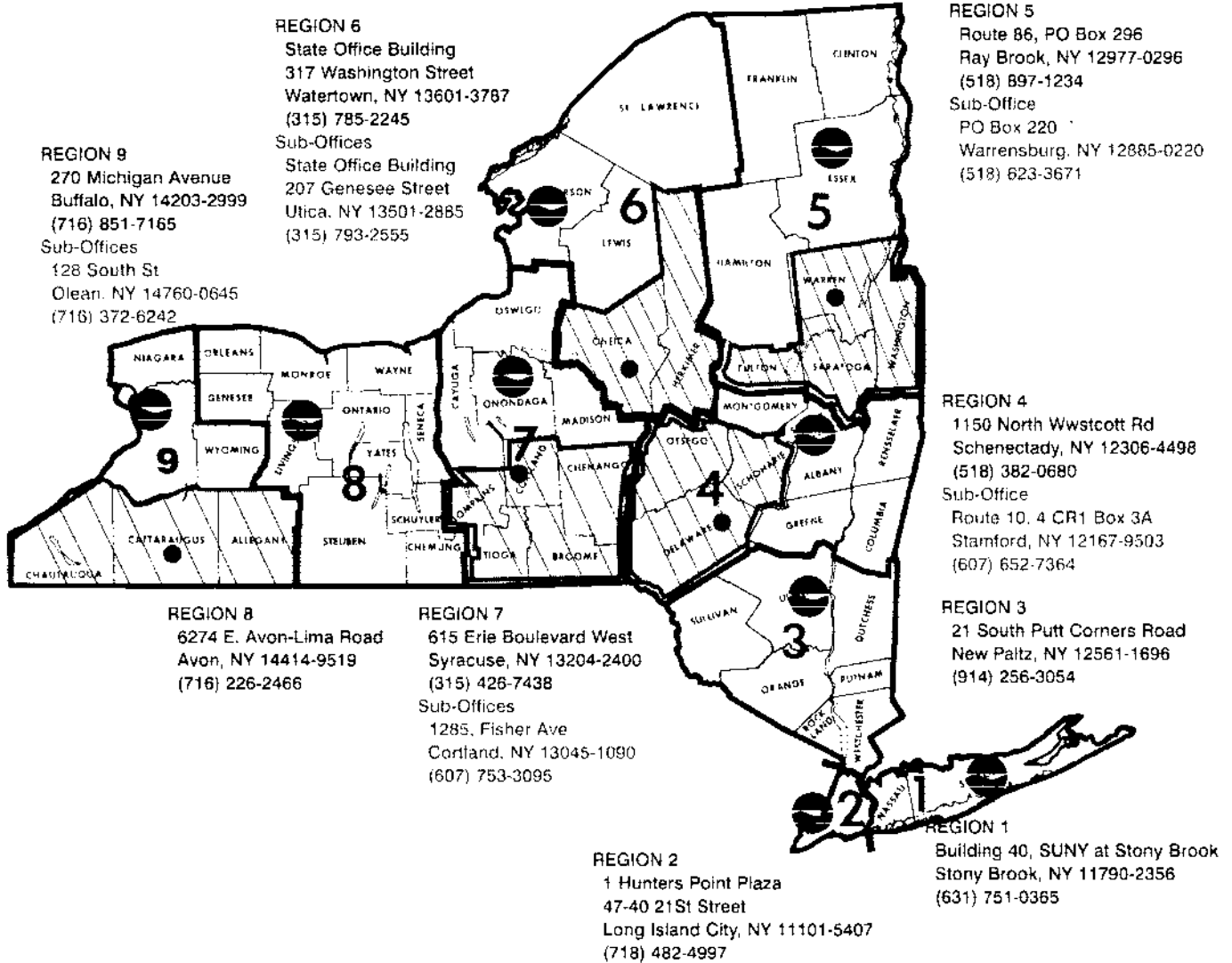

LEGEND

 Regional Headquarters

 Regional Sub-office
 (Sub-office responsible for areas printed in blue cross-hatch.)

This page is left intentionally blank

Appendix B

This page is left intentionally blank

This Appendix presents two hydrologic and hydraulic analysis tools that can be used to size stormwater management practices (SMPs). The first is the TR-55 (NRCS, 1986) “short-cut” sizing technique, used to size practices designed for extended detention, slightly modified to incorporate the small flows necessary to provide channel protection. The second is a method used to determine the peak flow from water quality storm events. (This is often important when the water quality storm is diverted to a water quality practice, with other larger events bypassed).

B.1 Storage Volume Estimation

This section presents a modified version of the TR-55 short cut sizing approach. The method was modified by Harrington (1987), for applications where the peak discharge is very small compared with the uncontrolled discharge. This often occurs in the 1-year, 24-hour detention sizing.

Using TR-55 guidance (NRCS, 1986), the unit peak discharge (q_u) can be determined based on the the Curve Number and Time of Concentration. Knowing q_u and T (extended detention time), q_o/q_i (peak outflow discharge/peak inflow discharge) can be estimated from Figure B.1.

Figure B.2 can also be used to estimate V_s/V_r . For a Type II or Type III rainfall distribution, V_s/V_r can also be calculated using the following equation:

$$V_s/V_r = 0.682 - 1.43 (q_o/q_i) + 1.64 (q_o/q_i)^2 - 0.804 (q_o/q_i)^3 \quad (2.1.16)$$

Where:

- V_s = required storage volume (acre-feet)
- V_r = runoff volume (acre-feet)
- q_o = peak outflow discharge (cfs)
- q_i = peak inflow discharge (cfs)

The required storage volume can then be calculated by:

$$V_s = \frac{(V_s/V_r)(Q_d)(A)}{12} \quad (2.1.17)$$

Where: V_s and V_r are defined above

Q_d = the post-developed runoff for the design storm (inches)

A = total drainage area (acres)

While the TR-55 short-cut method reports to incorporate multiple stage structures, experience has shown that an additional 10-15% storage is required when multiple levels of extended detention are provided.

Figure B.1 Detention Time vs. Discharge Ratios (Source: MDE, 2000)

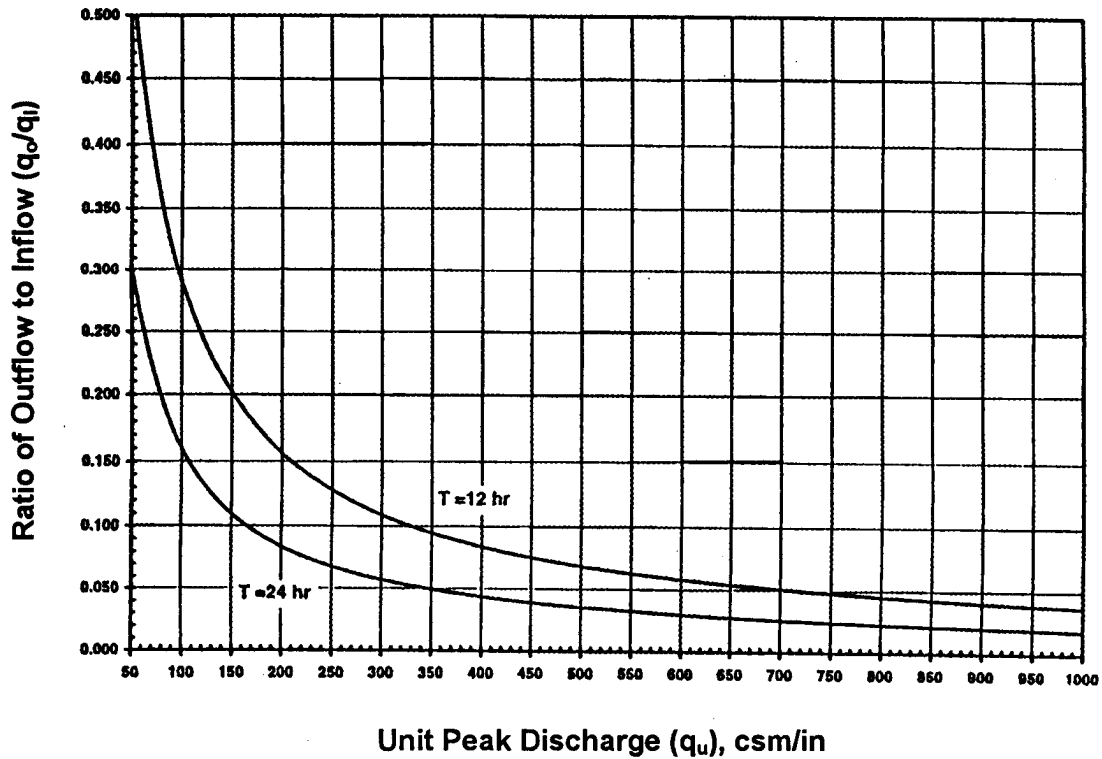
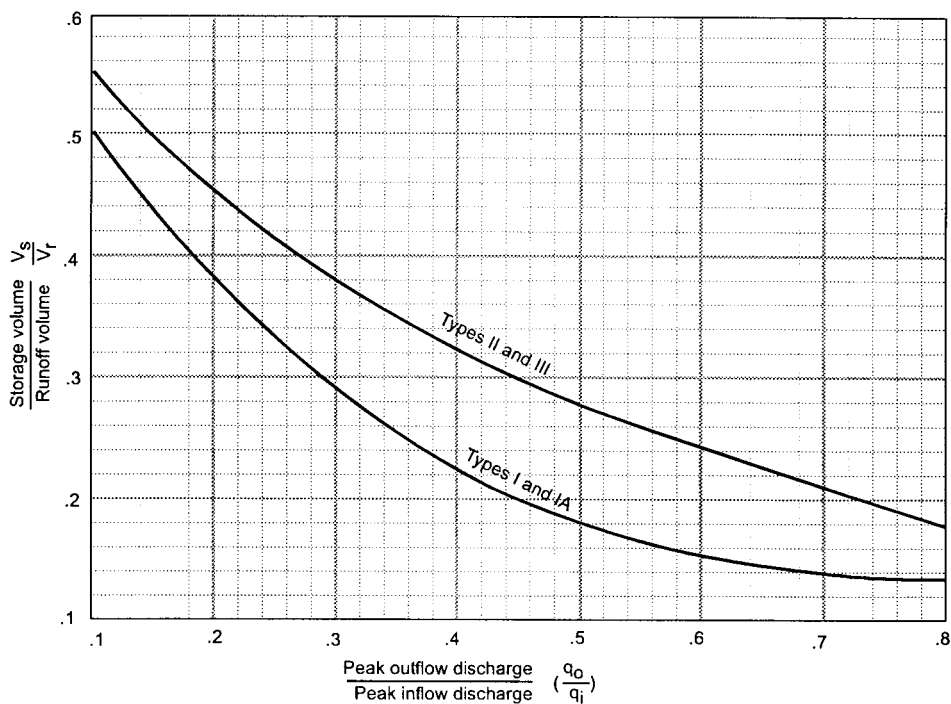

Figure B.2 Approximate Detention Basin Routing For Rainfall Types I, IA, II, and III (Source: NRCS, 1986)



B.2 Water Quality Peak Flow Calculation

The peak rate of discharge for the water quality design storm is needed for the sizing of diversion structures for off-line practices such as sand filters. An arbitrary storm would need to be chosen using the Rational method, and conventional SCS methods have been found to underestimate the volume and rate of runoff for rainfall events less than 2". This discrepancy in estimating runoff and discharge rates can lead to situations where a significant amount of runoff by-passes the filtering treatment practice due to an inadequately sized diversion structure and leads to the design of undersized bypass channels.

The following procedure can be used to estimate peak discharges for small storm events. It relies on the Water Quality Volume and the simplified peak flow estimating method above. A brief description of the calculation procedure is presented below.

Using the water quality volume (WQ_V), a corresponding Curve Number (CN) is computed utilizing the following equation:

$$CN = 1000/[10 + 5P + 10Q - 10(Q^2 + 1.25QP)^{1/2}]$$

Where

P = rainfall, in inches (use the 90% rainfall event from Figure 4.1 for the Water Quality Storm)

Q = runoff volume, in inches

Once a CN is computed, the time of concentration (t_c) is computed using guidance provided in TR-55.

Using the computed CN, t_c and drainage area (A), in acres; the peak discharge (Q_p) for the water quality storm event is computed (either Type II or Type III in the State of New York).

Read initial abstraction (I_a), compute I_a/P

Read the unit peak discharge (q_u) for appropriate t_c

Using the water quality volume (WQ_V), compute the peak discharge (Q_p)

$$Q_p = q_u * A * WQ_V$$

where Q_p = the peak discharge, in cfs

q_u = the unit peak discharge, in cfs/mi²/inch

A = drainage area, in square miles

WQ_V = Water Quality Volume, in watershed inches

References

- Harrington, B.W. 1987. Design Procedures for Stormwater Management Extended Detention Structures. Report to Water Resources Administration. Maryland Department of Natural Resources. Annapolis, MD.
- Maryland Department of the Environment (MDE). 2000. Maryland Stormwater Design Manual. Baltimore, MD.
- Natural Resources Conservation Service (NRCS). 1986. Urban Hydrology for Small Watersheds. Technical Release No. 55. USDA. Washington D.C.

This page is left intentionally blank

Appendix C

This page is left intentionally blank

Appendix C: Construction Standards and Specifications**C.1 Pond Construction Standards/Specifications**

These specifications are generally appropriate to all earthen ponds, and are adapted from NRCS Pond Code 378. This document is available at <http://www.dec.state.ny.us/website/dow/toolbox/tools.html>. Practitioners should always consult the New York State Department of Environmental Conservation – Dam Safety Division for the most recent guidance. All references to ASTM and AASHTO specifications apply to the most recent version.

C.2 Construction Specifications for Infiltration Practices

Infiltration Trench General Notes and Specifications

The infiltration trench systems may not receive run-off until the entire contributing drainage area to the infiltration system has received final stabilization.

1. Heavy equipment and traffic shall be restricted from traveling over the infiltration trench to minimize compaction of the soil.
2. Excavate the infiltration trench to the design dimensions. Excavated materials shall be placed away from the trench sides to enhance trench wall stability. Large tree roots must be trimmed flush with the trench sides in order to prevent fabric puncturing or tearing of the filter fabric during subsequent installation procedures. The side walls of the trench shall be roughened where sheared and sealed by heavy equipment.
3. A Class "C" geotextile or better shall interface between the trench side walls and between the stone reservoir and gravel filter layers. A partial list of non-woven filter fabrics that meet the Class "C" criteria is contained below. Any alternative filter fabric must be approved by the local municipality prior to installation.

Mirafi 180-N
Amoco 4552
WEBTEC N70
GEOLON N70
Carthage FX-80S

The width of the geotextile must include sufficient material to conform to trench perimeter irregularities and for a 6-inch minimum top overlap. The filter fabric shall be tucked under the sand layer on the bottom of the infiltration trench for a distance of 6 to 12 inches. Stones or other anchoring objects should be placed on the fabric at the edge of the trench to keep the trench open during windy periods. When overlaps are required between rolls, the uphill roll should lap a minimum of 2 feet over the downhill roll in order to provide a shingled effect.

4. A 6 inch sand layer may be placed on the bottom of the infiltration trench in lieu of filter fabric, and shall be compacted using plate compactors. The sand for the infiltration trench shall be washed and meet AASHTO Std. M-43, Size No. 9 or No. 10. Any alternative sand gradation must be approved by the Engineer or the local municipality.
5. The stone aggregate should be placed in lifts and compacted using plate compactors. A maximum loose lift thickness of 12 inches is recommended. Gravel filling (rounded bank run gravel is preferred) for the infiltration trench shall be washed and meet one of the following: AASHTO Std. M-43; Size No. 2 or No. 3.
6. Following the stone aggregate placement, the filter fabric shall be folded over the stone aggregate to form a 6-inch minimum longitudinal lap. The desired fill soil or stone aggregate shall be placed over the lap at sufficient intervals to maintain the lap during subsequent backfilling.
7. Care shall be exercised to prevent natural or fill soils from intermixing with the stone aggregate. All contaminated stone aggregate shall be removed and replaced with uncontaminated stone aggregate.

8. Voids can be created between the fabric and the excavation sides and shall be avoided. Removing boulders or other obstacles from the trench walls is one source of such voids, therefore, natural soils should be placed in these voids at the most convenient time during construction to ensure fabric conformity to the excavation sides.
9. Vertically excavated walls may be difficult to maintain in areas where soil moisture is high or where soft cohesive or cohesionless soils are predominate. These conditions may require laying back of the side slopes to maintain stability.
10. PVC distribution pipes shall be Schedule 40 and meet ASTM Std. D 1784. All fittings and perforations (1/2 inch in diameter) shall meet ASTM Std. D 2729. A perforated pipe shall be provided only within the infiltration trench and shall terminate 1 foot short of the infiltration trench wall. The end of the PVC pipe shall be capped.
11. Corrugated metal distribution pipes shall conform to AASHTO Std. M-36, and shall be aluminized in accordance with AASHTO Std. M-274. Coat aluminized pipe in contact with concrete with an inert compound capable of effecting isolation of the deleterious effect of the aluminum on the concrete. Perforated distribution pipe shall be provided only within the infiltration trench and shall terminate 1 foot short of the infiltration trench wall. An aluminized metal plate shall be welded to the end of the pipe.
12. The observation well is to consist of 6-inch diameter PVC Schedule 40 pipe (ASTM Std. D 1784) with a cap set 6 inches above ground level and is to be located near the longitudinal center of the infiltration trench. Preferably the observation well will not be located in vehicular traffic areas. The pipe shall have a plastic collar with ribs to prevent rotation when removing cap. The screw top lid shall be a "Panella" type cleanout with a locking mechanism or special bolt to discourage vandalism. A perforated (1/2 inch in diameter) PVC Schedule 40 pipe shall be provided and placed vertically within the gravel portion of the infiltration trench and a cap provided at the bottom of the pipe. The bottom of the cap shall rest on the infiltration trench bottom.
13. If a distribution structure with a wet well is used, a 4-inch PVC drain pipe shall be provided at opposite ends of the infiltration trench distribution structure. Two (2) cubic feet of porous backfill meeting AASHTO Std. M-43 Size No. 57 shall be provided at each drain.
14. If a distribution structure is used, the manhole cover shall be bolted to the frame.

NOTE: PVC pipe with a wall thickness classification of SDR-35 meeting ASTM standard D3034 is an acceptable substitution for PVC Schedule 40 pipe.

Infiltration Basins Notes and Specifications

1. The sequence of various phases of basin construction shall be coordinated with the overall project construction schedule. A program should schedule rough excavation of the basin (to not less than 2' from final grade) with the rough grading phase of the project to permit use of the material as fill in earthwork areas. The partially excavated basin, however, **cannot** serve as a sedimentation basin.

Specifications for basin construction should state: (1) the earliest point in progress when storm drainage may be directed to the basin, and (2) the means by which this delay in use is to be

accomplished. Due to the wide variety of conditions encountered among projects, each should be separately evaluated in order to postpone use as long as is reasonably possible.

2. Initial basin excavation should be carried to within 2 feet of the final elevation of the basin floor. Final excavation to the finished grade should be deferred until all disturbed areas on the watershed have been stabilized or protected. The final phase excavation should remove all accumulated sediment. Relatively light tracked equipment is recommended for this operation to avoid compaction of the basin floor. After the final grading is completed, the basin should retain a highly porous surface texture.
3. Infiltration basins may be lined with a 6- to 12-inch layer of filter material such as coarse sand (AASHTO Std. M-43, Sizes 9 or 10) to help prevent the buildup of impervious deposits on the soil surface. The filter layer can be replaced or cleaned when it becomes clogged. When a 6-inch layer of coarse organic material is specified for discing (such as hulls, leaves, stems, etc.) or spading into the basin floor to increase the permeability of the soils, the basin floor should be soaked or inundated for a brief period, then allowed to dry subsequent to this operation. This induces the organic material to decay rapidly, loosening the upper soil layer.
4. Establishing dense vegetation on the basin side slopes and floor is recommended. A dense vegetative stand will not only prevent erosion and sloughing, but will also provide a natural means of maintaining relatively high infiltration rates. Erosion protection of inflow points to the basin shall also be provided.
5. Selection of suitable vegetative materials for the side slope and all other areas to be stabilized with vegetation and application of required lime, fertilizer, etc. shall be done in accordance with the NRCS Standards and Specifications or your local Standards and Specifications for Soil Erosion and Sediment Control.
6. Grasses of the fescue family are recommended for seeding primarily due to their adaptability to dry sandy soils, drought resistance, hardiness, and ability to withstand brief inundations. The use of fescues will also permit long intervals between mowings. This is important due to the relatively steep slopes which make mowing difficult. Mowing twice a year, once in June and again in September, is generally satisfactory.

C.3 Construction Specifications for Bioretention, Sand Filters and Open Channels

Sand Filter Specifications

Material Specifications for Sand Filters

The allowable materials for sand filter construction are detailed in Table 1.

Sand Filter Testing Specifications

Underground sand filters, facilities within sensitive groundwater aquifers, and filters designed to serve urban hot spots are to be tested for water tightness prior to placement of filter layers. Entrances and exits should be plugged and the system completely filled with water to demonstrate water tightness.

All overflow weirs, multiple orifices and flow distribution slots to be field-tested as to verify adequate distribution of flows.

Sand Filter Construction Specifications

Provide sufficient maintenance access; 12-foot-wide road with legally recorded easement. Vegetated access slopes to be a maximum of 10%; gravel slopes to 15%; paved slopes to 25%.

Absolutely no runoff is to enter the filter until all contributing drainage areas have been stabilized.

Surface of filter bed to be *completely level*.

All sand filters should be clearly delineated with signs so that they may be located when maintenance is due.

Surface sand filters shall be planted with appropriate grasses as specified in your local NRCS Standards and Specifications guidance.

Pocket sand filters (and residential bioretention facilities treating areas larger than an acre) shall be sized with an ornamental stone window covering approximately 10% of the filter area. This surface shall be 2" to 5" size stone on top of a pea gravel layer (3/4 inch stone) approximately 4 to 6" of pea gravel.

Specifications Pertaining to Underground Sand Filters

Provide manhole and/or grates to all underground and below grade structures. Manholes shall be in compliance with standard specifications for each jurisdiction but diameters should be 30" minimum (to comply with OSHA confined space requirements) but not too heavy to lift. Aluminum and steel louvered doors are also acceptable. Ten-inch long (minimum) manhole steps (12" o.c.) shall be cast in place or drilled and mortared into the wall below each manhole. A 5" minimum height clearance (from the top of the sand layer to the bottom of the slab) is required for all permanent underground structures. Lift rings are to be supplied to remove/replace top slabs. Manholes may need to be grated to allow for proper ventilation; if required, place manholes *away* from areas of heavy pedestrian traffic.

Underground sand filters shall be constructed with a dewatering gate valve located just above the top of the filter bed should the bed clog.

Underground sand beds shall be protected from trash accumulation by a wide mesh geotextile screen to be placed on the surface of the sand bed; screen is to be rolled up, removed, cleaned and re-installed during maintenance operations.

Table C-1 Sand Filter Material Specifications

Parameter	Specification	Size	Notes
Sand	Clean AASHTO M-6 or ASTM C-33 concrete sand	0.02” to 0.04”	Sand substitutions such as Diabase and Graystone #10 are not acceptable. No calcium carbonated or dolomitic sand substitutions are acceptable. “Rock dust” cannot be substituted for sand.
Peat	Ash content: < 15% PH range: 5.2 to 4.9 Loose bulk density 0.12 to 0.15 g/cc	n/a	The material must be Reed-Sedge Hemic Peat, shredded, uncompacted, uniform, and clean.
Underdrain Gravel	AASHTO M-43 No. 67	0.25” to 0.75”	
Geotextile Fabric (if required)	ASTM D-751 (puncture strength - 125 lb.) ASTM D-1117 (Mullen Burst Strength - 400 psi) ASTM D-1682 (Tensile Strength - 300 lb.)	0.08” thick equivalent opening size of #80 sieve	Must maintain 125 gpm per sq. ft. flow rate. Note: a 4” pea gravel layer may be substituted for geotextiles meant to separate sand filter layers.
Impermeable Liner (if required)	ASTM D 751 (thickness) ASTM D 412 (tensile strength 1,100 lb., elongation 200%) ASTM D 624 (Tear resistance - 150 lb./in) ASTM D 471 (water adsorption: +8 to -2% mass)	30mil thickness	Liner to be ultraviolet resistant. A geotextile fabric should be used to protect the liner from puncture.
Underdrain Piping	ASTM D-1785 or AASHTO M-278	6” rigid schedule 40 PVC	3/8” perf. 6” on center, 4 holes per row; minimum of 3” of gravel over pipes; not necessary underneath pipes
Concrete (Cast-in-place)	See local DOT Standards and Specs. f=c = 3500 psi, normal weight, air-entrained; re-inforcing to meet ASTM 615-60	n/a	on-site testing of poured-in-place concrete required: 28 day strength and slump test; all concrete design (cast-in-place or pre-cast) <i>not using previously approved State or local standards</i> requires design drawings sealed and approved by a licensed professional structural engineer.
Concrete (pre-cast)	per pre-cast manufacturer	n/a	SEE ABOVE NOTE
Non-rebar steel	ASTM A-36	n/a	structural steel to be hot-dipped galvanized ASTM A123

Specifications for Bioretention

Material Specifications

The allowable materials to be used in bioretention area are detailed in Table G.2.

Planting Soil

The soil shall be a uniform mix, free of stones, stumps, roots or other similar objects larger than two inches. No other materials or substances shall be mixed or dumped within the bioretention area that may be harmful to plant growth, or prove a hindrance to the planting or maintenance operations. The planting soil shall be free of noxious weeds.

The planting soil shall be tested and shall meet the following criteria:

pH range	5.2 - 7.0
organic matter	1.5 - 4%
magnesium	35 lb./ac
phosphorus P ₂ O ₅	75 lb./ac
potassium K ₂ O	85 lb./ac
soluble salts	not to exceed 500 ppm

All bioretention areas shall have a minimum of one test. Each test shall consist of both the standard soil test for pH, phosphorus, and potassium and additional tests of organic matter, and soluble salts. A textural analysis is required from the site stockpiled topsoil. If topsoil is imported, then a texture analysis shall be performed for each location where the top soil was excavated.

Since different labs calibrate their testing equipment differently, all testing results shall come from the same testing facility.

Should the pH fall out of the acceptable range, it may be modified (higher) with lime or (lower) with iron sulfate plus sulfur.

Compaction

It is very important to minimize compaction of both the base of the bioretention area and the required backfill. When possible, use excavation hoes to remove original soil. If bioretention areas are excavated using a loader, the contractor should use wide track or marsh track equipment, or light equipment with turf type tires. Use of equipment with narrow tracks or narrow tires, rubber tires with large lugs, or high pressure tires will cause excessive compaction resulting in reduced infiltration rates and storage volumes and is not acceptable. Compaction will significantly contribute to design failure.

Compaction can be alleviated at the base of the bioretention facility by using a primary tilling operation such as a chisel plow, ripper, or subsoiler. These tilling operations are to refracture the soil profile through the 12 inch compaction zone. Substitute methods must be approved by the engineer. Rototillers typically do not till deep enough to reduce the effects of compaction from heavy equipment.

Rototill 2 to 3 inches of sand into the base of the bioretention facility before back filling the required sand layer. Pump any ponded water before preparing (rototilling) base.

When back filling the topsoil over the sand layer, first place 3 to 4 inches of topsoil over the sand, then rototill the sand/topsoil to create a gradation zone. Backfill the remainder of the topsoil to final grade.

When back filling the bioretention facility, place soil in lifts 12" or greater. Do not use heavy equipment within the bioretention basin. Heavy equipment can be used around the perimeter of the basin to supply soils and sand. Grade bioretention materials by hand or with light equipment such as a compact loader or a dozer/loader with marsh tracks.

Plant Installation

Mulch around individual plants only. Shredded hardwood mulch is the only accepted mulch. Pine mulch and wood chips will float and move to the perimeter of the bioretention area during a storm event and are not acceptable. Shredded mulch must be well aged (6 to 12 months) for acceptance.

The plant root ball should be planted so 1/8th of the ball is above final grade surface.

Root stock of the plant material shall be kept moist during transport and on-site storage. The diameter of the planting pit shall be at least six inches larger than the diameter of the planting ball. Set and maintain the plant straight during the entire planting process. Thoroughly water ground bed cover after installation.

Trees shall be braced using 2" X 2" stakes only as necessary and for the first growing season only. Stakes are to be equally spaced on the outside of the tree ball.

Grasses and legume seed shall be tilled into the soil to a depth of at least one inch. Grass and legume plugs shall be planted following the non-grass ground cover planting specifications.

The topsoil specifications provide enough organic material to adequately supply nutrients from natural cycling. The primary function of the bioretention structure is to improve water quality. Adding fertilizers defeats, or at a minimum, impedes this goal. Only add fertilizer if wood chips or mulch is used to amend the soil. Rototill urea fertilizer at a rate of 2 pounds per 1000 square feet.

Underdrains

Under drains to be placed on a 3'-0" wide section of filter cloth. Pipe is placed next, followed by the gravel bedding. The ends of under drain pipes not terminating in an observation well shall be capped.

The main collector pipe for underdrain systems shall be constructed at a minimum slope of 0.5%. Observation wells and/or clean-out pipes must be provided (one minimum per every 1000 square feet of surface area).

Miscellaneous

The bioretention facility may not be constructed until all contributing drainage area has been stabilized.

Table C.2 Materials Specifications for Bioretention

Parameter	Specification	Size	Notes
Plantings	see your local NRCS Standards and Specifications guidance.	n/a	plantings are site-specific
Planting Soil [4= deep]	sand 35 - 60% silt 30 - 55% clay 10 - 25%	n/a	USDA soil types loamy sand, sandy loam or loam
Mulch	shredded hardwood		aged 6 months, minimum
pea gravel diaphragm and curtain drain	pea gravel: ASTM D 448 ornamental stone: washed cobbles	pea gravel: No. 6 stone: 2" to 5"	
Geotextile	Class "C" apparent opening size (ASTM-D-4751) grab tensile strength (ASTM-D-4632) burst strength (ASTM-D-4833)	n/a	for use as necessary beneath underdrains only
underdrain gravel	AASHTO M-43. No. 67.	0.25" to 0.75"	
underdrain piping	ASTM D 1785 or AASHTO M-278	6" rigid schedule 40 PVC	3/8" perf. @ 6" on center, 4 holes per row; minimum of 3" of gravel over pipes; not necessary underneath pipes
poured in place concrete (if required)	See local DOT Standards and Specs.; f=c = 3500 psi. @ 28 days, normal weight, air-entrained; re-inforcing to meet ASTM 615-60	n/a	on-site testing of poured-in-place concrete required: 28 day strength and slump test; all concrete design (cast-in-place or pre-cast) <i>not using previously approved State or local standards</i> requires design drawings sealed and approved by a licensed professional structural engineer.
sand [1= deep]	AASHTO M-6 or ASTM C-33	0.02" to 0.04"	Sand substitutions such as Diabase and Graystone #10 are not acceptable. No calcium carbonated or dolomitic sand substitutions are acceptable. No "rock dust" can be used for sand.

Specifications for Open Channels and Filter Strips

Material Specifications

The recommended construction materials for open channels and filter strips are detailed in Table G.3.

Dry Swales

Roto-till soil/gravel interface approximately 6" to avoid a sharp soil/gravel interface.

Permeable soil mixture (20" to 30" deep) should meet the bioretention planting soil specifications.

Check dams, if required, shall be placed as specified.

System to have 6" of freeboard, minimum.

Side slopes to be 3:1 minimum; (4:1 or greater preferred).

No gravel or perforated pipe is to be placed under driveways.

Bottom of facility to be above the seasonably high water table.

Seed with flood/drought resistant grasses; see your local NRCS Standards and Specifications guidance.

Longitudinal slope to be 1 to 2%, maximum [up to 5% with check dams].

Bottom width to be 8' = maximum to avoid braiding; larger widths may be used if proper berming is supplied.
Width to be 2' = minimum.

Wet Swales

Follow above information for dry swales, with the following exceptions: the seasonally high water table may inundate the swale; but not above the design bottom of the channel [NOTE: if the water table is stable within the channel; the WQv storage may start at this point]

Excavate into undisturbed soils; do not use an underdrain system.

Filter Strips

Construct pea gravel diaphragms 12" wide, minimum, and 24" deep minimum.

Pervious berms to be a sand/gravel mix (35-60% sand, 30-55% silt, and 10-25% gravel). Berms to have overflow weirs with 6 inch minimum available head.

Slope range to be 2% minimum to 6% maximum.

Table C.3 Open Vegetated Swale and Filter Strip Materials Specifications

Parameter	Specification	Size	Notes
Dry swale soil	USCS; ML, SM, SC	n/a	soil with a higher percent organic content is preferred
Dry Swale sand	ASTM C-33 fine aggregate concrete sand	0.02” to 0.04”	
Check Dam (pressure treated)	AWPA Standard C6	6” by 6” or 8” by 8”	<i>do not</i> coat with creosote; embed at least 3= into side slopes
Check Dam (natural wood)	Black Locust, Red Mulberry, Cedars, Catalpa, White Oak, Chestnut Oak, Black Walnut	6” to 12” diameter; notch as necessary	<i>do not</i> use the following, as these species have a predisposition towards rot: Ash, Beech, Birch, Elm, Hackberry, hemlock, Hickories, Maples, Red and Black Oak, Pines, Poplar, Spruce, Sweetgum, Willow
Filter Strip sand/gravel pervious berm	sand: per dry swale sand gravel; AASHTO M-43 No. 57	sand: 0.02” to 0.04” gravel: 2” to 1”	mix with approximately 25% loan soil to support grass cover crop; see Bioretention planting soil notes for more detail.
pea gravel diaphragm and curtain drain	ASTM D 448	varies (No. 6) or (1/8” to 3/8”)	use clean bank-run gravel
under drain gravel	AASHTO M-43 No. 67	0.25” to 0.75”	
under drain	ASTM D -1785 or AASHTO M-278	6” rigid Schedule 40 PVC	3/8” perf. @ 6” o.c.; 4 holes per row
Geotextile	See local DOT Standards and Specs	n/a	
rip rap	per local DOT criteria	size per New York State DOT requirements based on 10-year design flows	

This page is left intentionally blank

Appendix D

This page is left intentionally blank

General Notes Pertinent to All Testing

1. For infiltration practices, a minimum field infiltration rate (f_c) of 0.5 inches per hour is required; areas yielding a lower rate preclude these practices. If the minimum f_c exceeds two inches per hour, half of the WQ_v must be treated by an upstream SMP that does allow infiltration. For F-1 and F-6 practices, no minimum infiltration rate is required if these facilities are designed with a “day-lighting” underdrain system; otherwise these facilities require a 0.5 inch per hour rate.
2. Number of required borings is based on the size of the proposed facility. Testing is done in two phases, (1) Initial Feasibility, and (2) Concept Design Testing.
3. Testing is to be conducted by a qualified professional. This professional shall either be a registered professional engineer in the State of New York, a soils scientist or geologist also licensed in the State of New York.

Initial Feasibility Testing

Feasibility testing is conducted to determine whether full-scale testing is necessary, and is meant to screen unsuitable sites, and reduce testing costs. A soil boring is not required at this stage. However, a designer or landowner may opt to engage Concept Design Borings per Table H-1 at his or her discretion, without feasibility testing.

Initial testing involves either one field test per facility, regardless of type or size, or previous testing data, such as the following:

- * septic percolation testing on-site, within 200 feet of the proposed SMP location, and on the same contour [can establish initial rate, water table and/or depth to bedrock]
- * previous written geotechnical reporting on the site location as prepared by a qualified geotechnical consultant
- * NRCS County Soil Mapping *showing an unsuitable soil group* such as a hydrologic group “D” soil in a low-lying area, or a Marlboro Clay

If the results of initial feasibility testing as determined by a qualified professional show that an infiltration rate of greater than 0.5 inches per hour is probable, then the number of *concept design test* pits shall be per the following table. An encased soil boring may be substituted for a test pit, if desired.

Table D-1 Infiltration Testing Summary Table

Type of Facility	Initial Feasibility Testing	Concept Design Testing (initial testing yields a rate greater than 0.5"/hr)	Concept Design Testing (initial testing yields a rate lower than 0.5"/hr)
I-1 (trench)	1 field percolation test, test pit not required	1 infiltration test and 1 test pit per 50' of trench	not acceptable practice
I-2 (basin)	1 field percolation test, test pit not required	1 infiltration test* and 1 test pit per 200 sf of basin area	not acceptable practice
F-1 (sand filter)	1 field percolation test, test pit not required	1 infiltration test and 1 test pit per 200 sf of filter area (no underdrains required**)	underdrains required
F-6 (bioretention)	1 field percolation test, test pit not required	1 infiltration test and 1 test pit per 200 sf of filter area (no underdrains required**)	underdrains required

*feasibility test information already counts for one test location

** underdrain installation still strongly suggested

Documentation

Infiltration testing data shall be documented, which shall also include a description of the infiltration testing method, if completed. This is to ensure that the tester understands the procedure.

Test Pit/Boring Requirements

- a. excavate a test pit or dig a standard soil boring to a minimum depth of 4 feet below the proposed facility bottom elevation
- b. determine depth to groundwater table (if within 4 feet of proposed bottom) upon initial digging or drilling, and again 24 hours later
- c. conduct Standard Penetration Testing (SPT) every 2' to a depth of 4 feet below the facility bottom
- d. determine USDA or Unified Soil Classification System textures at the proposed bottom and 4 feet below the bottom of the SMP
- e. determine depth to bedrock (if within 4 feet of proposed bottom)
- f. The soil description should include all soil horizons.
- g. The location of the test pit or boring shall correspond to the SMP location; test pit/soil boring stakes are to be left in the field for inspection purposes and shall be clearly labeled as such.

Infiltration Testing Requirements

- a. Install casing (solid 4-6 inch diameter, 30" length) to 24" below proposed SMP bottom (see Figure D-1).

- b. Remove any smeared soiled surfaces and provide a natural soil interface into which water may percolate. Remove all loose material from the casing. Upon the tester's discretion, a two (2) inch layer of coarse sand or fine gravel may be placed to protect the bottom from scouring and sediment. Fill casing with *clean* water to a depth of 24" and allow to pre-soak for twenty-four hours
- c. Twenty-four hours later, refill casing with another 24" of clean water and monitor water level (measured drop from the top of the casing) for 1 hour. Repeat this procedure (filling the casing each time) three additional times, for a total of four observations. Upon the tester's discretion, the final field rate may either be the average of the four observations, or the value of the last observation. The final rate shall be reported in *inches per hour*.
- d. May be done through a boring or open excavation.
- e. The location of the test shall correspond to the SMP location.
- f. Upon completion of the testing, the casings shall be immediately pulled, and the test pit shall be back-filled.

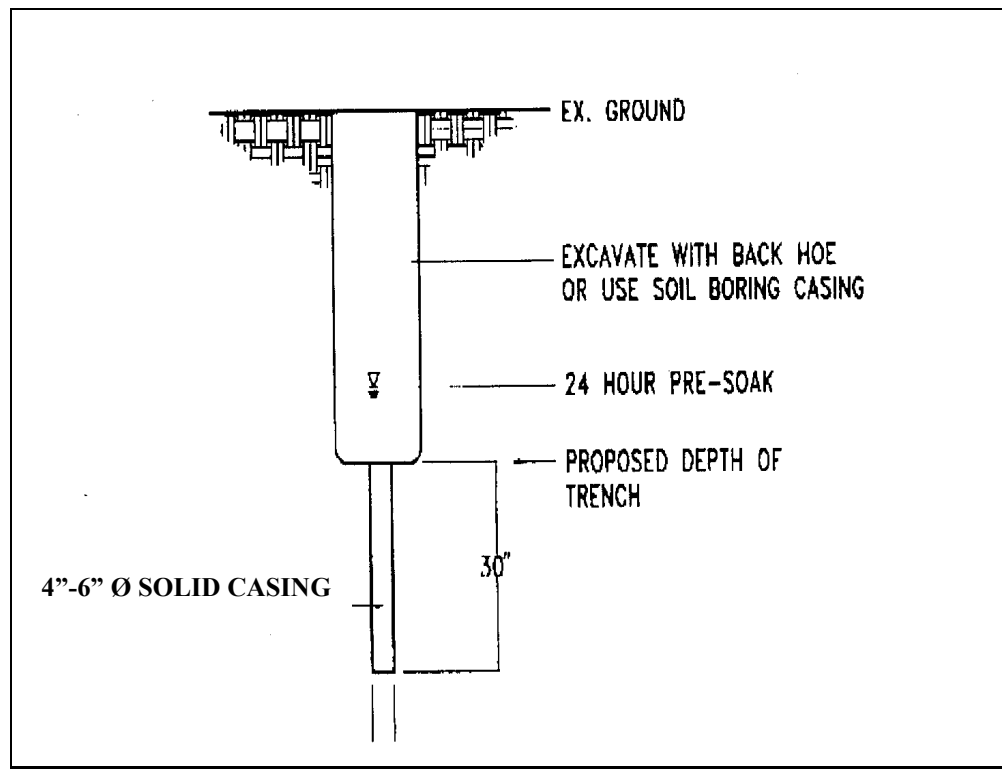
Figure D.1 Infiltration Testing Requirements**Laboratory Testing**

- a. Grain-size sieve analysis and hydrometer tests where appropriate may be used to determine USDA soils classification and textural analysis. Visual field inspection by a qualified professional may also be used, provided it is documented. *The use of lab testing to establish infiltration rates is prohibited.*

Bioretention Testing

All areas to be used as bioretention facilities shall be back-filled with a suitable sandy loam planting media. The borrow source of this media, which may be the same or different location from the bioretention area itself, must be tested as follows:

If the borrow area is virgin, undisturbed soil, one test is required per 200 sf of borrow area; the test consists of “grab” samples at one foot depth intervals to the bottom of the borrow area. All samples at the testing location are then mixed, and the resulting sample is then lab-tested to meet the following criteria:

- a) USDA minimum textural analysis requirements: A textural analysis is required from the site stockpiled topsoil. If topsoil is imported, then a texture analysis shall be performed for each location where the top soil was excavated.

Minimum requirements:

sand	35 - 60%
silt	30 - 55%
clay	10 - 25%

- b) The soil shall be a uniform mix, free of stones, stumps, roots or other similar objects larger than two inches.
- c) Consult the bioretention construction specifications (Appendix J) for further guidance on preparing the soil for a bioretention area.

This page is left intentionally blank

Appendix E

This page is left intentionally blank

Example Checklist for Preliminary/Concept Stormwater Management Plan Preparation and Review

- Applicant information
- Name, legal address, and telephone number
- Common address and legal description of site
- Vicinity map
- Existing and proposed mapping and plans (recommended scale of 1" = 50'.) which illustrate at a minimum:
 - < Existing and proposed topography (minimum of 2-foot contours recommended)
 - < Perennial and intermittent streams
 - < Mapping of predominant soils from USDA soil surveys
 - < Boundaries of existing predominant vegetation and proposed limits of clearing
 - < Location and boundaries of resource protection areas such as wetlands, lakes, ponds, and other setbacks (e.g., stream buffers, drinking water well setbacks, septic setbacks)
 - < Location of existing and proposed roads, buildings, and other structures
 - < Existing and proposed utilities (e.g., water, sewer, gas, electric) and easements
 - < Location of existing and proposed conveyance systems such as grass channels, swales, and storm drains
 - < Flow paths
 - < Location of floodplain/floodway limits and relationship of site to upstream and downstream properties and drainages
 - < Preliminary location and dimensions of proposed channel modifications, such as bridge or culvert crossings
 - < Preliminary location, size, and limits of disturbance of proposed stormwater treatment practices
- Hydrologic and hydraulic analysis including:
 - < Existing condition analysis for runoff rates, volumes, and velocities presented showing methodologies used and supporting calculations
 - < Proposed condition analysis for runoff rates, volumes, and velocities showing the methodologies used and supporting calculations
 - < Preliminary analysis of potential downstream impact/effects of project, where necessary
 - < Preliminary selection and rationale for structural stormwater management practices
 - < Preliminary sizing calculations for stormwater treatment practices including contributing drainage area, storage, and outlet configuration
- Preliminary landscaping plans for stormwater treatment practices and any site reforestation or revegetation
- Preliminary erosion and sediment control plan that at a minimum meets the requirements outlined in local Erosion and Sediment Control guidelines
- Identification of preliminary waiver requests

Example Checklist for Final Stormwater Management Plan Preparation and Review

- Applicant information
 - Name, legal address, and telephone number
- Common address and legal description of site
- Signature and stamp of registered engineer/surveyor and design/owner certification
- Vicinity map
- Existing and proposed mapping and plans (recommended scale of 1" = 50' or greater detail) which illustrate at a minimum:
 - < Existing and proposed topography (minimum of 2-foot contours recommended)
 - < Perennial and intermittent streams
 - < Mapping of predominant soils from USDA soil surveys as well as location of any site-specific borehole investigations that may have been performed.
 - < Boundaries of existing predominant vegetation and proposed limits of clearing
 - < Location and boundaries of resource protection areas such as wetlands, lakes, ponds, and other setbacks (e.g., stream buffers, drinking water well setbacks, septic setbacks)
 - < Location of existing and proposed roads, buildings, and other structures
 - < Location of existing and proposed utilities (e.g., water, sewer, gas, electric) and easements
 - < Location of existing and proposed conveyance systems such as grass channels, swales, and storm drains
 - < Flow paths
 - < Location of floodplain/floodway limits and relationship of site to upstream and downstream properties and drainages
 - < Location and dimensions of proposed channel modifications, such as bridge or culvert crossings
 - < Location, size, maintenance access, and limits of disturbance of proposed structural stormwater Management practices
- Representative cross-section and profile drawings and details of structural stormwater Management practices and conveyances (i.e., storm drains, open channels, swales, etc.) which include:
 - < Existing and proposed structural elevations (e.g., invert of pipes, manholes, etc.)
 - < Design water surface elevations
 - < Structural details of outlet structures, embankments, spillways, stilling basins, grade control structures, conveyance channels, etc.
 - < Logs of borehole investigations that may have been performed along with supporting geotechnical report.

- Hydrologic and hydraulic analysis for all structural components of stormwater system (e.g., storm drains, open channels, swales, Management practices, etc.) for applicable design storms including:
 - Existing condition analysis for time of concentrations, runoff rates, volumes, velocities, and water surface elevations showing methodologies used and supporting calculations
 - < Proposed condition analysis for time of concentrations, runoff rates, volumes, velocities, water surface elevations, and routing showing the methodologies used and supporting calculations
 - < Final sizing calculations for structural stormwater Management practices including, contributing drainage area, storage, and outlet configuration
 - < Stage-discharge or outlet rating curves and inflow and outflow hydrographs for storage facilities (e.g., stormwater ponds and wetlands)
 - < Final analysis of potential downstream impact/effects of project, where necessary
 - < Dam breach analysis, where necessary
- Final landscaping plans for structural stormwater Management practices and any site reforestation or revegetation
- Structural calculations, where necessary
- Applicable construction specifications
- Erosion and sediment control plan that at a minimum meets the requirements of the local Erosion and Sediment Control Guidelines
- Sequence of construction
- Maintenance plan which will include:
 - < Name, address, and phone number of responsible parties for maintenance.
 - < Description of annual maintenance tasks
 - < Description of applicable easements
 - < Description of funding source
 - < Minimum vegetative cover requirements
 - < Access and safety issues
 - < Testing and disposal of sediments that will likely be necessary
- Evidence of acquisition of all applicable local and non-local permits
- Evidence of acquisition of all necessary legal agreements (e.g., easements, covenants, land trusts)
- Waiver requests
- Review agency should have inspector's checklist identifying potential features to be inspected on site visits

This page is left intentionally blank

Appendix F

This page is left intentionally blank

Stormwater/Wetland Pond Construction Inspection Checklist

Project:
 Location:
 Site Status:

Date:

Time:

Inspector:

CONSTRUCTION SEQUENCE	SATISFACTORY/ UNSATISFACTORY	COMMENTS
Pre-Construction/Materials and Equipment		
Pre-construction meeting		
Pipe and appurtenances on-site prior to construction and dimensions checked		
1. Material (including protective coating, if specified)		
2. Diameter		
3. Dimensions of metal riser or pre-cast concrete outlet structure		
4. Required dimensions between water control structures (orifices, weirs, etc.) are in accordance with approved plans		
5. Barrel stub for prefabricated pipe structures at proper angle for design barrel slope		
6. Number and dimensions of prefabricated anti-seep collars		
7. Watertight connectors and gaskets		
8. Outlet drain valve		
Project benchmark near pond site		
Equipment for temporary de-watering		

CONSTRUCTION SEQUENCE	SATISFACTORY/ UNSATISFACTORY	COMMENTS
2. Subgrade Preparation		
Area beneath embankment stripped of all vegetation, topsoil, and organic matter		
3. Pipe Spillway Installation		
Method of installation detailed on plans		
A. Bed preparation		
Installation trench excavated with specified side slopes		
Stable, uniform, dry subgrade of relatively impervious material (If subgrade is wet, contractor shall have defined steps before proceeding with installation)		
Invert at proper elevation and grade		
B. Pipe placement		
Metal / plastic pipe		
1. Watertight connectors and gaskets properly installed		
2. Anti-seep collars properly spaced and having watertight connections to pipe		
3. Backfill placed and tamped by hand under “haunches” of pipe		
4. Remaining backfill placed in max. 8 inch lifts using small power tamping equipment until 2 feet cover over pipe is reached		

CONSTRUCTION SEQUENCE	SATISFACTORY/ UNSATISFACTORY	COMMENTS
3. Pipe Spillway Installation		
Concrete pipe		
1. Pipe set on blocks or concrete slab for pouring of low cradle		
2. Pipe installed with rubber gasket joints with no spalling in gasket interface area		
3. Excavation for lower half of anti-seep collar(s) with reinforcing steel set		
4. Entire area where anti-seep collar(s) will come in contact with pipe coated with mastic or other approved waterproof sealant		
5. Low cradle and bottom half of anti-seep collar installed as monolithic pour and of an approved mix		
6. Upper half of anti-seep collar(s) formed with reinforcing steel set		
7. Concrete for collar of an approved mix and vibrated into place (protected from freezing while curing, if necessary)		
8. Forms stripped and collar inspected for honeycomb prior to backfilling. Parge if necessary.		
C. Backfilling		
Fill placed in maximum 8 inch lifts		
Backfill taken minimum 2 feet above top of anti-seep collar elevation before traversing with heavy equipment		

CONSTRUCTION SEQUENCE	SATISFACTORY/ UNSATISFACTORY	COMMENTS
4. Riser / Outlet Structure Installation		
Riser located within embankment		
A. Metal riser		
Riser base excavated or formed on stable subgrade to design dimensions		
Set on blocks to design elevations and plumbed		
Reinforcing bars placed at right angles and projecting into sides of riser		
Concrete poured so as to fill inside of riser to invert of barrel		
B. Pre-cast concrete structure		
Dry and stable subgrade		
Riser base set to design elevation		
If more than one section, no spalling in gasket interface area; gasket or approved caulking material placed securely		
Watertight and structurally sound collar or gasket joint where structure connects to pipe spillway		
C. Poured concrete structure		
Footing excavated or formed on stable subgrade, to design dimensions with reinforcing steel set		
Structure formed to design dimensions, with reinforcing steel set as per plan		
Concrete of an approved mix and vibrated into place (protected from freezing while curing, if necessary)		
Forms stripped & inspected for “honeycomb” prior to backfilling; parge if necessary		

CONSTRUCTION SEQUENCE	SATISFACTORY/ UNSATISFACTORY	COMMENTS
5. Embankment Construction		
Fill material		
Compaction		
Embankment		
1. Fill placed in specified lifts and compacted with appropriate equipment		
2. Constructed to design cross-section, side slopes and top width		
3. Constructed to design elevation plus allowance for settlement		
6. Impounded Area Construction		
Excavated / graded to design contours and side slopes		
Inlet pipes have adequate outfall protection		
Forebay(s)		
Pond benches		
7. Earth Emergency Spillway Construction		
Spillway located in cut or structurally stabilized with riprap, gabions, concrete, etc.		
Excavated to proper cross-section, side slopes and bottom width		
Entrance channel, crest, and exit channel constructed to design grades and elevations		

CONSTRUCTION SEQUENCE	SATISFACTORY / UNSATISFACTORY	COMMENTS
8. Outlet Protection		
A. End section		
Securely in place and properly backfilled		
B. Endwall		
Footing excavated or formed on stable subgrade, to design dimensions and reinforcing steel set, if specified		
Endwall formed to design dimensions with reinforcing steel set as per plan		
Concrete of an approved mix and vibrated into place (protected from freezing, if necessary)		
Forms stripped and structure inspected for “honeycomb” prior to backfilling; parge if necessary		
C. Riprap apron / channel		
Apron / channel excavated to design cross-section with proper transition to existing ground		
Filter fabric in place		
Stone sized as per plan and uniformly place at the thickness specified		
9. Vegetative Stabilization		
Approved seed mixture or sod		
Proper surface preparation and required soil amendments		
Excelsior mat or other stabilization, as per plan		

CONSTRUCTION SEQUENCE	SATISFACTORY/ UNSATISFACTORY	COMMENTS
10. Miscellaneous		
Drain for ponds having a permanent pool		
Trash rack / anti-vortex device secured to outlet structure		
Trash protection for low flow pipes, orifices, etc.		
Fencing (when required)		
Access road		
Set aside for clean-out maintenance		
11. Stormwater Wetlands		
Adequate water balance		
Variety of depth zones present		
Approved pondscaping plan in place Reinforcement budget for additional plantings		
Plants and materials ordered 6 months prior to construction		
Construction planned to allow for adequate planting and establishment of plant community (April-June planting window)		
Wetland buffer area preserved to maximum extent possible		

Comments:

Actions to be Taken:

Infiltration Trench Construction Inspection Checklist

Project:
 Location:
 Site Status:

Date:

Time:

Inspector:

CONSTRUCTION SEQUENCE	SATISFACTORY/ UNSATISFACTORY	COMMENTS
1. Pre-Construction		
Pre-construction meeting		
Runoff diverted		
Soil permeability tested		
Groundwater / bedrock sufficient at depth		
2. Excavation		
Size and location		
Side slopes stable		
Excavation does not compact subsoils		
3. Filter Fabric Placement		
Fabric specifications		
Placed on bottom, sides, and top		

CONSTRUCTION SEQUENCE	SATISFACTORY / UNSATISFACTORY	COMMENTS
4. Aggregate Material		
Size as specified		
Clean / washed material		
Placed properly		
5. Observation Well		
Pipe size		
Removable cap / footplate		
Initial depth = _____ feet		
6. Final Inspection		
Pretreatment facility in place		
Contributing watershed stabilized prior to flow diversion		
Outlet		

Comments:

Actions to be Taken:

Infiltration Basin Construction Inspection Checklist

Project:
 Location:
 Site Status:

Date:

Time:

Inspector:

CONSTRUCTION SEQUENCE	SATISFACTORY/ UNSATISFACTORY	COMMENTS
1. Pre-Construction		
Runoff diverted		
Soil permeability tested		
Groundwater / bedrock depth		
2. Excavation		
Size and location		
Side slopes stable		
Excavation does not compact subsoils		
3. Embankment		
Barrel		
Anti-seep collar or Filter diaphragm		
Fill material		

CONSTRUCTION SEQUENCE	SATISFACTORY/ UNSATISFACTORY	COMMENTS
4. Final Excavation		
Drainage area stabilized		
Sediment removed from facility		
Basin floor tilled		
Facility stabilized		
5. Final Inspection		
Pretreatment facility in place		
Inlets / outlets		
Contributing watershed stabilized before flow is routed to the facility		

Comments:

Actions to be Taken:

Sand/Organic Filter System Construction Inspection Checklist

Project:
 Location:
 Site Status:

Date:

Time:

Inspector:

CONSTRUCTION SEQUENCE	SATISFACTORY / UNSATISFACTORY	COMMENTS
1. Pre-construction		
Pre-construction meeting		
Runoff diverted		
Facility area cleared		
Facility location staked out		
2. Excavation		
Size and location		
Side slopes stable		
Foundation cleared of debris		
If designed as exfilter, excavation does not compact subsoils		
Foundation area compacted		
3. Structural Components		
Dimensions and materials		
Forms adequately sized		
Concrete meets standards		
Prefabricated joints sealed		
Underdrains (size, materials)		

CONSTRUCTION SEQUENCE	SATISFACTORY / UNSATISFACTORY	COMMENTS
4. Completed Facility Components		
24 hour water filled test		
Contributing area stabilized		
Filter material per specification		
Underdrains installed to grade		
Flow diversion structure properly installed		
Pretreatment devices properly installed		
Level overflow weirs, multiple orifices, distribution slots		
5. Final Inspection		
Dimensions		
Surface completely level		
Structural components		
Proper outlet		
Ensure that site is properly stabilized before flow is directed to the structure.		

Comments:

Actions to be Taken:

Bioretention Construction Inspection Checklist

Project:
 Location:
 Site Status:

Date:

Time:

Inspector:

CONSTRUCTION SEQUENCE	SATISFACTORY/ UNSATISFACTORY	COMMENTS
1. Pre-Construction		
Pre-construction meeting		
Runoff diverted		
Facility area cleared		
If designed as exfilter, soil testing for permeability		
Facility location staked out		
2. Excavation		
Size and location		
Lateral slopes completely level		
If designed as exfilter, ensure that excavation does not compact susoils.		
Longitudinal slopes within design range		

CONSTRUCTION SEQUENCE	SATISFACTORY / UNSATISFACTORY	COMMENTS
3. Structural Components		
Stone diaphragm installed correctly		
Outlets installed correctly		
Underdrain		
Pretreatment devices installed		
Soil bed composition and texture		
4. Vegetation		
Complies with planting specs		
Topsoil adequate in composition and placement		
Adequate erosion control measures in place		
5. Final Inspection		
Dimensions		
Proper stone diaphragm		
Proper outlet		
Soil/ filter bed permeability testing		
Effective stand of vegetation and stabilization		
Construction generated sediments removed		
Contributing watershed stabilized before flow is diverted to the practice		

Open Channel System Construction Inspection Checklist

Project:
 Location:
 Site Status:

Date:

Time:

Inspector:

CONSTRUCTION SEQUENCE	SATISFACTORY / UNSATISFACTORY	COMMENTS
1. Pre-Construction		
Pre-construction meeting		
Runoff diverted		
Facility location staked out		
2. Excavation		
Size and location		
Side slope stable		
Soil permeability		
Groundwater / bedrock		
Lateral slopes completely level		
Longitudinal slopes within design range		
Excavation does not compact subsoils		
3. Check dams		
Dimensions		
Spacing		
Materials		

CONSTRUCTION SEQUENCE	SATISFACTORY / UNSATISFACTORY	COMMENTS
4. Structural Components		
Underdrain installed correctly		
Inflow installed correctly		
Pretreatment devices installed		
5. Vegetation		
Complies with planting specifications		
Topsoil adequate in composition and placement		
Adequate erosion control measures in place		
6. Final inspection		
Dimensions		
Check dams		
Proper outlet		
Effective stand of vegetation and stabilization		
Contributing watershed stabilized before flow is routed to the facility		

Comments:

This page is left intentionally blank

Appendix G

This page is left intentionally blank

Stormwater Pond/Wetland Operation, Maintenance and Management Inspection Checklist

Project _____
 Location: _____
 Site Status: _____

 Date: _____
 Time: _____

 Inspector: _____

Maintenance Item	Satisfactory/ Unsatisfactory	Comments
1. Embankment and emergency spillway (Annual, After Major Storms)		
1. Vegetation and ground cover adequate		
2. Embankment erosion		
3. Animal burrows		
4. Unauthorized planting		
5. Cracking, bulging, or sliding of dam		
a. Upstream face		
b. Downstream face		
c. At or beyond toe		
downstream		
upstream		
d. Emergency spillway		
6. Pond, toe & chimney drains clear and functioning		
7. Seeps/leaks on downstream face		
8. Slope protection or riprap failure		
9. Vertical/horizontal alignment of top of dam "As-Built"		

Maintenance Item	Satisfactory/ Unsatisfactory	Comments
10. Emergency spillway clear of obstructions and debris		
11. Other (specify)		
2. Riser and principal spillway (Annual)		
Type: Reinforced concrete _____ Corrugated pipe _____ Masonry _____		
1. Low flow orifice obstructed		
2. Low flow trash rack. a. Debris removal necessary		
b. Corrosion control		
3. Weir trash rack maintenance a. Debris removal necessary		
b. corrosion control		
4. Excessive sediment accumulation insider riser		
5. Concrete/masonry condition riser and barrels a. cracks or displacement		
b. Minor spalling (<1")		
c. Major spalling (rebars exposed)		
d. Joint failures		
e. Water tightness		
6. Metal pipe condition		
7. Control valve a. Operational/exercised		
b. Chained and locked		
8. Pond drain valve a. Operational/exercised		
b. Chained and locked		
9. Outfall channels functioning		
10. Other (specify)		

Maintenance Item	Satisfactory/ Unsatisfactory	Comments
3. Permanent Pool (Wet Ponds) (monthly)		
1. Undesirable vegetative growth		
2. Floating or floatable debris removal required		
3. Visible pollution		
4. Shoreline problem		
5. Other (specify)		
4. Sediment Forebays		
1. Sedimentation noted		
2. Sediment cleanout when depth < 50% design depth		
5. Dry Pond Areas		
1. Vegetation adequate		
2. Undesirable vegetative growth		
3. Undesirable woody vegetation		
4. Low flow channels clear of obstructions		
5. Standing water or wet spots		
6. Sediment and / or trash accumulation		
7. Other (specify)		
6. Condition of Outfalls (Annual , After Major Storms)		
1. Riprap failures		
2. Slope erosion		
3. Storm drain pipes		
4. Endwalls / Headwalls		
5. Other (specify)		
7. Other (Monthly)		
1. Encroachment on pond, wetland or easement area		

Maintenance Item	Satisfactory/ Unsatisfactory	Comments
2. Complaints from residents		
3. Aesthetics a. Grass growing required		
b. Graffiti removal needed		
c. Other (specify)		
4. Conditions of maintenance access routes.		
5. Signs of hydrocarbon build-up		
6. Any public hazards (specify)		
8. Wetland Vegetation (Annual)		
1. Vegetation healthy and growing Wetland maintaining 50% surface area coverage of wetland plants after the second growing season. (If unsatisfactory, reinforcement plantings needed)		
2. Dominant wetland plants: Survival of desired wetland plant species Distribution according to landscaping plan?		
3. Evidence of invasive species		
4. Maintenance of adequate water depths for desired wetland plant species		
5. Harvesting of emergent plantings needed		
6. Have sediment accumulations reduced pool volume significantly or are plants "choked" with sediment		
7. Eutrophication level of the wetland.		
8. Other (specify)		

Comments:

Actions to be Taken:

Infiltration Trench Operation, Maintenance, and Management Inspection Checklist

Project:
 Location:
 Site Status:

Date:

Time:

Inspector:

MAINTENANCE ITEM	SATISFACTORY / UNSATISFACTORY	COMMENTS
1. Debris Cleanout (Monthly)		
Trench surface clear of debris		
Inflow pipes clear of debris		
Overflow spillway clear of debris		
Inlet area clear of debris		
2. Sediment Traps or Forebays (Annual)		
Obviously trapping sediment		
Greater than 50% of storage volume remaining		
3. Dewatering (Monthly)		
Trench dewaterers between storms		
4. Sediment Cleanout of Trench (Annual)		
No evidence of sedimentation in trench		
Sediment accumulation doesn't yet require cleanout		
5. Inlets (Annual)		

MAINTENANCE ITEM	SATISFACTORY / UNSATISFACTORY	COMMENTS
Good condition		
No evidence of erosion		
6. Outlet/Overflow Spillway (Annual)		
Good condition, no need for repair		
No evidence of erosion		
7. Aggregate Repairs (Annual)		
Surface of aggregate clean		
Top layer of stone does not need replacement		
Trench does not need rehabilitation		

Comments:

Actions to be Taken:

Sand/Organic Filter Operation, Maintenance and Management Inspection Checklist

Project:
Location:
Site Status:

Date:

Time:

Inspector:

MAINTENANCE ITEM	SATISFACTORY / UNSATISFACTORY	COMMENTS
1. Debris Cleanout (Monthly)		
Contributing areas clean of debris		
Filtration facility clean of debris		
Inlet and outlets clear of debris		
2. Oil and Grease (Monthly)		
No evidence of filter surface clogging		
Activities in drainage area minimize oil and grease entry		
3. Vegetation (Monthly)		
Contributing drainage area stabilized		
No evidence of erosion		
Area mowed and clipping removed		
4. Water Retention Where Required (Monthly)		
Water holding chambers at normal pool		
No evidence of leakage		
5. Sediment Deposition (Annual)		

MAINTENANCE ITEM	SATISFACTORY / UNSATISFACTORY	COMMENTS
Filter chamber free of sediments		
Sedimentation chamber not more than half full of sediments		
6. Structural Components (Annual)		
No evidence of structural deterioration		
Any grates are in good condition		
No evidence of spalling or cracking of structural parts		
7. Outlet/Overflow Spillway (Annual)		
Good condition, no need for repairs		
No evidence of erosion (if draining into a natural channel)		
8. Overall Function of Facility (Annual)		
Evidence of flow bypassing facility		
No noticeable odors outside of facility		

Comments:

Actions to be Taken:

Bioretention Operation, Maintenance and Management Inspection Checklist

Project:
 Location:
 Site Status:

Date:

Time:

Inspector:

MAINTENANCE ITEM	SATISFACTORY / UNSATISFACTORY	COMMENTS
1. Debris Cleanout (Monthly)		
Bioretention and contributing areas clean of debris		
No dumping of yard wastes into practice		
Litter (branches, etc.) have been removed		
2. Vegetation (Monthly)		
Plant height not less than design water depth		
Fertilized per specifications		
Plant composition according to approved plans		
No placement of inappropriate plants		
Grass height not greater than 6 inches		
No evidence of erosion		
3. Check Dams/Energy Dissipaters/Sumps (Annual, After Major Storms)		
No evidence of sediment buildup		

MAINTENANCE ITEM	SATISFACTORY / UNSATISFACTORY	COMMENTS
Sumps should not be more than 50% full of sediment		
No evidence of erosion at downstream toe of drop structure		
4. Dewatering (Monthly)		
Dewaterers between storms		
No evidence of standing water		
5. Sediment Deposition (Annual)		
Swale clean of sediments		
Sediments should not be > 20% of swale design depth		
6. Outlet/Overflow Spillway (Annual, After Major Storms)		
Good condition, no need for repair		
No evidence of erosion		
No evidence of any blockages		
7. Integrity of Filter Bed (Annual)		
Filter bed has not been blocked or filled inappropriately		

Comments:

Actions to be Taken:

Open Channel Operation, Maintenance, and Management Inspection Checklist

Project:
 Location:
 Site Status:

Date:

Time:

Inspector:

MAINTENANCE ITEM	SATISFACTORY/ UNSATISFACTORY	COMMENTS
1. Debris Cleanout (Monthly)		
Contributing areas clean of debris		
2. Check Dams or Energy Dissipators (Annual, After Major Storms)		
No evidence of flow going around structures		
No evidence of erosion at downstream toe		
Soil permeability		
Groundwater / bedrock		
3. Vegetation (Monthly)		
Mowing done when needed		
Minimum mowing depth not exceeded		
No evidence of erosion		
Fertilized per specification		
4. Dewatering (Monthly)		
Dewaterers between storms		

MAINTENANCE ITEM	SATISFACTORY/ UNSATISFACTORY	COMMENTS
5. Sediment deposition (Annual)		
Clean of sediment		
6. Outlet/Overflow Spillway (Annual)		
Good condition, no need for repairs		
No evidence of erosion		

Comments:

Actions to be Taken:

This page is left intentionally blank

Appendix H

This page is left intentionally blank

H.1 Ponds and Wetlands

For areas that are to be planted within a stormwater pond, it is necessary to determine what type of hydrologic zones will be created within the pond. The following six zones describe the different conditions encountered in stormwater management facilities. Every facility does not necessarily reflect all of these zones. The hydrologic zones designate the degree of tolerance the plant exhibits to differing degrees of inundation by water.

Table H.5 at the end of this appendix designates appropriate zones for each plant. There may be other zones listed outside of these brackets. The plant materials may occur within these zones, but are not typically found in them. Plants suited for specific hydrologic conditions may perish when those conditions change, exposing the soil, and therefore, increasing the chance for erosion.

Each zone has its own set of plant selection criteria based on the hydrology of the zone, the stormwater functions required of the plant and the desired landscape effect. The hydrologic zones are as follows:

<u>Zone #</u>	<u>Zone Description</u>	<u>Hydrologic Conditions</u>
Zone 1	Deep Water Pool	1-6 feet deep Permanent Pool
Zone 2	Shallow Water Bench	6 inches to 1 foot deep
Zone 3	Shoreline Fringe	Regularly inundated
Zone 4	Riparian Fringe	Periodically inundated
Zone 5	Floodplain Terrace	Infrequently inundated
Zone 6	Upland Slopes	Seldom or never inundated

Zone 1: Deep Water Area (1- 6 Feet)

Ponds and wetlands both have deep pool areas that comprise Zone 1. These pools range from one to six feet in depth, and are best colonized by submergent plants, if at all.

This pondscaping zone has not been routinely planted for several reasons. First, the availability of plant materials that can survive and grow in this zone is limited, and it is also feared that plants could clog the stormwater facility outlet structure. In many cases, these plants will gradually become established through natural recolonization (e.g., transport of plant fragments from other ponds via the feet and legs of waterfowl). If submerged plant material becomes more commercially available and clogging concerns are addressed, this area can be planted. The function of the planting is to reduce resedimentation and improve oxidation while creating a greater aquatic habitat.

- < Plant material must be able to withstand constant inundation of water of one foot or greater in depth.
- < Plants may be submerged partially or entirely.
- < Plants should be able to enhance pollutant uptake.
- < Plants may provide food and cover for waterfowl, desirable insects, and other aquatic life.

Zone 2: Shallow Water Bench (*Normal Pool To 1 Foot*)

Zone 2 includes all areas that are inundated below the normal pool to a depth of one foot, and is the primary area where emergent plants will grow in a stormwater wetlands. Zone 2 also coincides with the aquatic bench found in stormwater ponds. This zone offers ideal conditions for the growth of many emergent wetland species. These areas may be located at the edge of the pond or on low mounds of earth located below the surface of the water within the pond. When planted, Zone 2 can be an important habitat for many aquatic and nonaquatic animals, creating a diverse food chain. This food chain includes predators, allowing a natural regulation of mosquito populations, thereby reducing the need for insecticidal applications.

- < Plant material must be able to withstand constant inundation of water to depths between six inches and one foot deep.
- < Plants will be partially submerged.
- < Plants should be able to enhance pollutant uptake.
- < Plants may provide food and cover for waterfowl, desirable insects and other aquatic life.

Plants will stabilize the bottom of the pond, as well as the edge of the pond, absorbing wave impacts and reducing erosion, when water level fluctuates. Plant also slow water velocities and increase sediment deposition rates. Plants can reduce resuspension of sediments caused by the wind. Plants can also soften the engineered contours of the pond, and can conceal drawdowns during dry weather.

Zone 3: Shoreline Fringe (*Regularly Inundated*)

Zone 3 encompasses the shoreline of a pond or wetland, and extends vertically about one foot in elevation from the normal pool. This zone includes the safety bench of a pond, and may also be periodically inundated if storm events are subject to extended detention. This zone occurs in a wet pond or shallow marsh and can be the most difficult to establish since plants must be able to withstand inundation of water during storms, when wind might blow water into the area, or the occasional drought during the summer. In order to stabilize the soil in this zone, Zone 3 must have a vigorous cover.

- < Plants should stabilize the shoreline to minimize erosion caused by wave and wind action or water fluctuation.
- < Plant material must be able to withstand occasional inundation of water. Plants will be partially submerged at this time.
- < Plant material should, whenever possible, shade the shoreline, especially the southern exposure. This will help to reduce the water temperature.

- < Plants should be able to enhance pollutant uptake.
- < Plants may provide food and cover for waterfowl, songbirds, and wildlife. Plants could also be selected and located to control overpopulation of waterfowl.
- < Plants should be located to reduce human access, where there are potential hazards, but should not block the maintenance access.
- < Plants should have very low maintenance requirements, since they may be difficult or impossible to reach.
- < Plants should be resistant to disease and other problems which require chemical applications (since chemical application is not advised in stormwater ponds).

Zone 4: Riparian Fringe (*Periodically Inundated*)

Zone 4 extends from one to four feet in elevation above the normal pool. Plants in this zone are subject to periodic inundation after storms, and may experience saturated or partly saturated soil conditions. Nearly all of the temporary ED area is included within this zone.

- < Plants must be able to withstand periodic inundation of water after storms, as well as occasional drought during the warm summer months.
- < Plants should stabilize the ground from erosion caused by run-off.
- < Plants should shade the low flow channel to reduce the pool warming whenever possible.
- < Plants should be able to enhance pollutant uptake.
- < Plant material should have very low maintenance, since they may be difficult or impossible to access.
- < Plants may provide food and cover for waterfowl, songbirds and wildlife. Plants may also be selected and located to control overpopulation of waterfowl.
- < Plants should be located to reduce pedestrian access to the deeper pools.

Zone 5: Floodplain Terrace (*Infrequently Inundated*)

Zone 5 is periodically inundated by flood waters that quickly recedes in a day or less. Operationally, Zone 5 extends from the maximum two year or C_{pv} water surface elevation up to the 10 or 100 year maximum water surface elevation. Key landscaping objectives for Zone 5 are to stabilize the steep slopes characteristic of this zone, and establish a low maintenance, natural vegetation.

- < Plant material should be able to withstand occasional but brief inundation during storms, although typical moisture conditions may be moist, slightly wet, or even swing entirely to drought conditions during the dry weather periods.
- < Plants should stabilize the basin slopes from erosion.
- < Ground cover should be very low maintenance, since they may be difficult to access on steep slopes or if frequency of mowing is limited. A dense tree cover may help reduce maintenance and discourage resident geese.
- < Plants may provide food and cover for waterfowl, songbirds, and wildlife.

- < Placement of plant material in Zone 5 is often critical, as it often creates a visual focal point and provides structure and shade for a greater variety of plants.

Zone 6: Upland Slopes (*Seldom or Never Inundated*)

The last zone extends above the maximum 100 year water surface elevation, and often includes the outer buffer of a pond or wetland. Unlike other zones, this upland area may have sidewalks, bike paths, retaining walls, and maintenance access roads. Care should be taken to locate plants so they will not overgrow these routes or create hiding places that might make the area unsafe.

- < Plant material is capable of surviving the particular conditions of the site. Thus, it is not necessary to select plant material that will tolerate any inundation. Rather, plant selections should be made based on soil condition, light, and function within the landscape.
- < Ground covers should emphasize infrequent mowing to reduce the cost of maintaining this landscape.
- < Placement of plants in Zone 6 is important since they are often used to create a visual focal point, frame a desirable view, screen undesirable views, serve as a buffer, or provide shade to allow a greater variety of plant materials. Particular attention should be paid to seasonal color and texture of these plantings.

H.2 Bioretention

Planting Soil Bed Characteristics

The characteristics of the soil for the bioretention facility are perhaps as important as the facility location, size, and treatment volume. The soil must be permeable enough to allow runoff to filter through the media, while having characteristics suitable to promote and sustain a robust vegetative cover crop. In addition, much of the nutrient pollutant uptake (nitrogen and phosphorus) is accomplished through adsorption and microbial activity within the soil profile. Therefore, the soils must balance soil chemistry and physical properties to support biotic communities above and below ground.

The planting soil should be a sandy loam, loamy sand, loam (USDA), or a loam/sand mix (should contain a minimum 35 to 60% sand, by volume). The clay content for these soils should be less than 25% by volume. Soils should fall within the SM, or ML classifications of the Unified Soil Classification System (USCS). A permeability of at least 1.0 feet per day (0.5"/hr) is required (a conservative value of 0.5 feet per day is used for design). The soil should be free of stones, stumps, roots, or other woody material over 1" in diameter. Brush or seeds from noxious weeds. Placement of the planting soil should be in lifts of 12 to 18", loosely compacted (tamped lightly with a dozer or backhoe bucket). The specific characteristics are presented in Table H.2.

Table H.2 Planting Soil Characteristics

Parameter	Value
PH range	5.2 to 7.00
Organic matter	1.5 to 4.0%
Magnesium	35 lbs. per acre, minimum
Phosphorus (P ₂ O ₅)	75 lbs. per acre, minimum
Potassium (K ₂ O)	85 lbs. per acre, minimum
Soluble salts	500 ppm
Clay	10 to 25%
Silt	30 to 55%
Sand	35 to 60%

Mulch Layer

The mulch layer plays an important role in the performance of the bioretention system. The mulch layer helps maintain soil moisture and avoid surface sealing which reduces permeability. Mulch helps prevent erosion, and provides a micro-environment suitable for soil biota at the mulch/soil interface. It also serves as a pretreatment layer, trapping the finer sediments which remain suspended after the primary pretreatment.

The mulch layer should be standard landscape style, single or double, shredded hardwood mulch or chips. The mulch layer should be well aged (stockpiled or stored for at least 12 months), uniform in color, and free of other materials, such as weed seeds, soil, roots, etc. The mulch should be applied to a maximum depth of three inches. Grass clippings should not be used as a mulch material.

Planting Plan Guidance

Plant material selection should be based on the goal of simulating a terrestrial forested community of native species. Bioretention simulates an ecosystem consisting of an upland-oriented community dominated by trees, but having a distinct community, or sub-canopy, of understory trees, shrubs and herbaceous materials. The intent is to establish a diverse, dense plant cover to treat stormwater runoff and withstand urban stresses from insect and disease infestations, drought, temperature, wind, and exposure.

The proper selection and installation of plant materials is key to a successful system. There are essentially three zones within a bioretention facility (Figure H.1). The lowest elevation supports plant species adapted to standing and fluctuating water levels. The middle elevation supports a slightly drier group of plants, but still tolerates fluctuating water levels. The outer edge is the highest elevation and generally supports plants adapted to dryer conditions. When using Table A.5 to identify species, use the following guideline:

Lowest Zone: Zones 2-3

Middle Zone: Zones 3-4

Outer Zone: Zones 5-6

The layout of plant material should be flexible, but should follow the general principals described in Table H.3. The objective is to have a system which resembles a random and natural plant layout, while maintaining optimal conditions for plant establishment and growth.

Figure H.1 Planting Zones for Bioretention Facilities

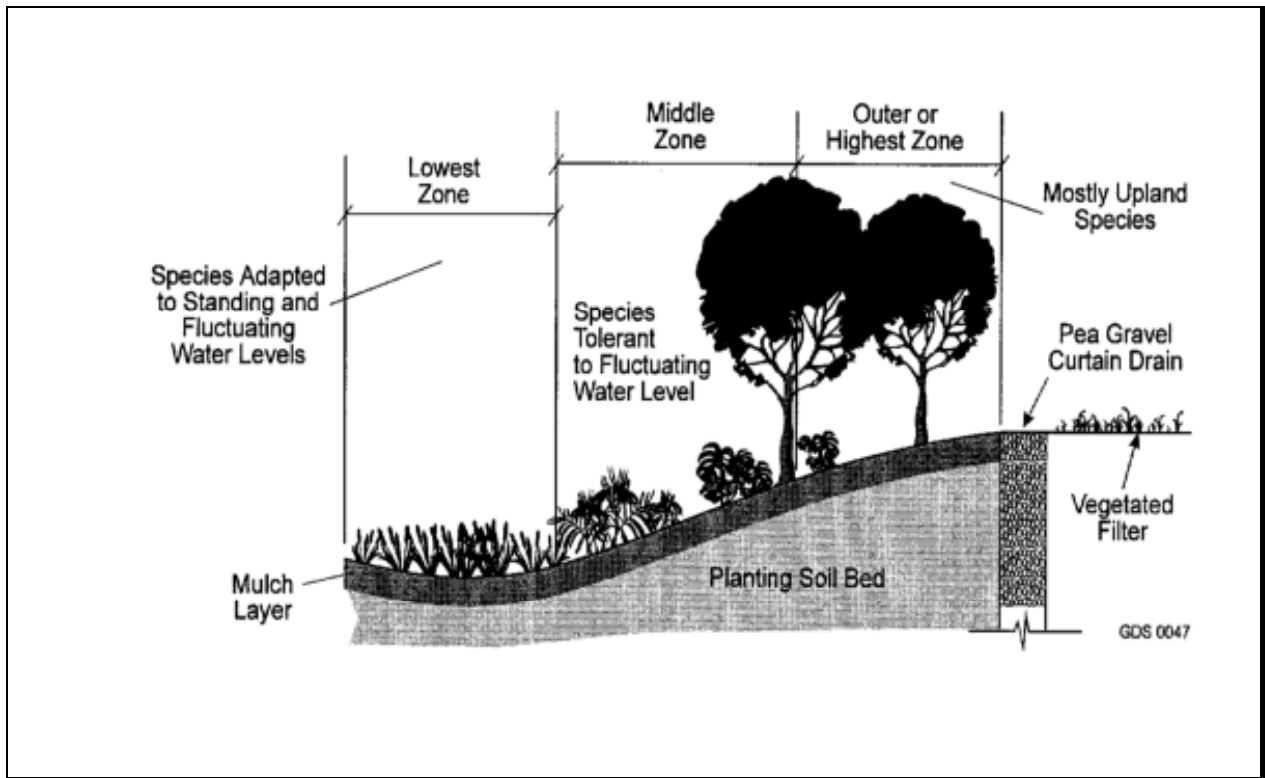

Table H.3 Planting Plan Design Considerations
Native plant species should be specified over exotic or foreign species.
Appropriate vegetation should be selected based on the zone of hydric tolerance (see Figure H.1).
Species layout should generally be random and natural.
A canopy should be established with an understory of shrubs and herbaceous materials.
Woody vegetation should not be specified in the vicinity of inflow locations.
Trees should be planted primarily along the perimeter of the bioretention area.
Urban stressors (e.g., wind, sun, exposure, insect and disease infestation, drought) should be considered when laying out the planting plan.
Noxious weeds should not be specified.
Aesthetics and visual characteristics should be a prime consideration.
Traffic and safety issues must be considered.
Existing and proposed utilities must be identified and considered.

Plant Material Guidance

Plant materials should conform to the American Standard Nursery Stock, published by the American Association of Nurserymen, and should be selected from certified, reputable nurseries. Planting specifications should be prepared by the designer and should include a sequence of construction, a description of the contractor's responsibilities, a planting schedule and installation specifications, initial maintenance, and a warranty period and expectations of plant survival. Table H.4 presents some typical issues for planting specifications.

Table H.4 Planting Specification Issues for Bioretention Areas	
Specification Element	Elements
Sequence of Construction	Describe site preparation activities, soil amendments, etc.; address erosion and sediment control procedures; specify step-by-step procedure for plant installation through site clean-up.
Contractor's Responsibilities	Specify the contractor's responsibilities, such as watering, care of plant material during transport, timeliness of installation, repairs due to vandalism, etc.
Planting Schedule and Specifications	Specify the materials to be installed, the type of materials (e.g., B&B, bare root, containerized); time of year of installations, sequence of installation of types of plants; fertilization, stabilization seeding, if required; watering and general care.
Maintenance	Specify inspection periods; mulching frequency (annual mulching is most common); removal and replacement of dead and diseased vegetation; treatment of diseased trees; watering schedule after initial installation (once per day for 14 days is common); repair and replacement of staking and wires.
Warranty	Specify the warranty period, the required survival rate, and expected condition of plant species at the end of the warranty period.

Table H.5 Native Plant Guide for Stormwater Management Areas (NY)						
Plant Name	Zone	Form	Available	Inundation Tolerance	Wildlife Value	Notes
Trees and Shrubs						
American Elm <i>(Ulmus americana)</i>	4,5,6	Dec. Tree	yes	Irregular-seasonal saturation	High. Food (seeds, browsing), cover, nesting for birds & mammals	Susceptible to disease (short-lived). Sun to full shade, tolerates drought and wind/ice damage.
Arrowwood Viburnum <i>(Viburnum dentatum)</i>	3,4	Dec. Shrub	yes	yes	High. Songbirds and mammals	Grows best in sun to partial shade
Bald Cypress <i>(Taxodium distichum)</i>	3,4	Dec. Tree	yes	yes	Little food value, but good perching site for waterfowl	Forested Coastal Plain. North of normal range. Tolerates drought.
Bayberry <i>(Myrica pensylvanica)</i>	4,5,6	Dec. Shrub	yes	yes	High. Nesting, food, cover. Berries last into winter	Coastal Plain only. Roots fix N ₂ . Tolerates slightly acidic soils.
Black Ash <i>(Fraxinus nigra)</i>	3,4,5	Dec. Tree	yes	Irregular-seasonal saturation	High. Food (seeds, sap), cover, nesting for birds & mammals. Fruit persists in winter	Rapid growth. Requires full sun. Susceptible to wind/ice damage & disease. Tolerates drought and infrequent flooding by salt water.
Black Cherry <i>(Prunus serotina)</i>	5,6	Dec. Tree	yes	no	High. Food	Moist soils or wet bottomland areas
Blackgum or Sourgum <i>(Nyssa sylvatica)</i>	4,5,6	Dec. Tree	yes	yes	High. Songbirds, egrets, herons, raccoons, owls	Can be difficult to transplant. Prefers sun to partial shade
Black Willow <i>(Salix nigra)</i>	3,4,5	Dec. Tree	yes	yes	High. Browsing and cavity nesters.	Rapid growth, stabilizes stream-banks. Full sun
Buttonbush <i>(Cephalanthus occidentalis)</i>	2,3,4,5	Dec. Shrub	yes	yes	High. Ducks and shorebirds. Seeds, nectar and nesting.	Full sun to partial shade. Will grow in dry areas.
Common Spice Bush <i>(Lindera benzoin)</i>	3,4,5	Dec. Shrub	yes	yes	Very high. Songbirds	Shade and rich soils. Tolerates acidic soils. Good understory species

Table H.5 Native Plant Guide for Stormwater Management Areas (NY)						
Plant Name	Zone	Form	Available	Inundation Tolerance	Wildlife Value	Notes
Eastern Cottonwood (<i>Populus deltoides</i>)	4,5	Dec. Tree	yes	yes	Moderate. Cover, food.	Shallow rooted, subject to windthrow. Invasive roots. Rapid growth.
Eastern Hemlock (<i>Tsuga canadensis</i>)	5,6	Conif. Tree	yes	yes	Moderate. Mostly cover and some food	Tolerates all sun/shade conditions. Tolerates acidic soil.
Eastern Red Cedar (<i>Juniperus virginiana</i>)	4,5,6	Conif. Tree	yes	no	High. Fruit for birds. Some cover.	Full sun to partial shade. Common in wetlands, shrub bogs and edge of stream
Elderberry (<i>Sambucus canadensis</i>)	3,4,5,6	Dec. Shrub	yes	yes	Extremely high. Food and cover, birds and mammals.	Full sun to partial shade.
Green Ash, Red Ash (<i>Fraxinus pennsylvanica</i>)	4,5	Dec. Tree	yes	yes	Moderate. Songbirds.	Rapid growing streambank stabilizer. Full sun to partial shade.
Hackberry (<i>Celtis occidentalis</i>)	5,6	Dec. Tree	yes	some	High. Food and cover	Full sun to partial shade.
Larch, Tamarack (<i>Larix laricina</i>)	3,4	Conif. Tree	no	yes	Low. Nest tree and seeds.	Rapid initial growth. Full sun, acidic boggy soil.
Pin Oak (<i>Quercus palustris</i>)	3,4,5,6	Dec. Tree	yes	yes	High. Tolerates acidic soil	Gypsy moth target. Prefers well drained, sandy soils.
Red Choke Berry (<i>Pyrus arbutifolia</i>)	3,4,5	Dec. Shrub	no	yes	Moderate. Songbirds.	Bank stabilizer. Partial sun.
Red Maple (<i>Acer rubrum</i>)	3,4,5,6	Dec. Tree	yes	yes	High seeds and browse. Tolerates acidic soil.	Rapid growth.
River Birch (<i>Betula nigra</i>)	3,4,5	Dec. Tree	yes	yes	Low. Good for cavity nesters.	Bank erosion control. Full sun.
Shadowbush, Serviceberry (<i>Amelanchier</i>)	4,5,6	Dec. Shrub	yes	yes	High. Nesting, cover, food. Birds and	Prefers partial shade. Common in forested

Table H.5 Native Plant Guide for Stormwater Management Areas (NY)						
Plant Name	Zone	Form	Available	Inundation Tolerance	Wildlife Value	Notes
<i>canadensis</i>)					mammals.	wetlands and upland woods.
Silky Dogwood (<i>Cornus amomium</i>)	3,4,5	Dec. Shrub	yes	yes	High. Songbirds, mammals.	Shade and drought tolerant. Good bank stabilizer.
Slippery Elm (<i>Ulmus rubra</i>)	3,4,5	Dec. Tree	rare	yes	High. Food (seeds, buds) for birds & mammals (browse). Nesting	Rapid growth, no salinity tolerance. Tolerant to shade and drought.
Smooth Alder (<i>Alnus serrulata</i>)	3,4,5	Dec. Tree	no	yes	High. Food, cover.	Rapid growth. Stabilizes streambanks.
Speckled Alder (<i>Alnus rugosa</i>)	3,4	Dec. Shrub	yes	yes	High. Cover, browse for deer, seeds for bird.	
Swamp White Oak (<i>Quercus bicolor</i>)	3,4,5	Dec. Tree	yes	yes	High. Mast	Full sun to partial shade. Good bottomland tree.
Swamp Rose (<i>Rosa Palustris</i>)	3,4	Dec. Shrub		Irregular, seasonal, or regularly saturated	High. Food (hips) for birds including turkey, ruffed grouse and mammals. Fox cover.	Prefers full sun. Easy to establish. Low salt tolerance.
Sweetgum (<i>Liquidambar styraciflua</i>)	4,5,6	Dec. Tree	yes	yes	Moderate. Songbirds	Tolerates acid or clay soils. Sun to partial shade.
Sycamore (<i>Platanus occidentalis</i>)	4,5,6,	Dec. Tree	yes	yes	Low. Food, cavities for nesting.	Rapid growth. Common in floodplains and alluvial woodlands.
Tulip Tree (<i>Liriodendron tulipifera</i>)	5,6	Dec. Tree	yes	no	Moderate. Seeds and nest sites	Full sun to partial shade. Well drained soils. Rapid growth.
Tupelo (<i>Nyssa sylvatica vari biflora</i>)	3,4,5	Dec. Tree	yes	yes	High. Seeds and nest sites	Ornamental

Table H.5 Native Plant Guide for Stormwater Management Areas (NY)						
Plant Name	Zone	Form	Available	Inundation Tolerance	Wildlife Value	Notes
White Ash (<i>Fraxinus americana</i>)	5,6	Dec. Tree	yes	no	High. Food	All sunlight conditions. Well drained soils.
Winterberry (<i>Ilex verticillata</i>)	3,4,5	Dec. Shrub	yes	yes	High. Cover and fruit for birds. Holds berries into winter.	Full sun to partial shade. Seasonally flooded areas.
Witch Hazel (<i>Hamamelis virginiana</i>)	4,5	Dec. Shrub	yes	no	Low. Food for squirrels, deer, and ruffed grouse.	Prefers shade. Ornamental.
Herbaceous Plants						
Arrow arum (<i>Peltandra virginica</i>)	2,3	Emergent	yes	up to 1 ft.	High. Berries are eaten by wood ducks.	Full sun to partial shade.
Arrowhead, Duck Potato (<i>Sagittaria latifolia</i>)	2,3	Emergent	yes	up to 1 ft.	Moderate. Tubers and seeds eaten by ducks.	Aggressive colonizer.
Big Bluestem (<i>Andropogon gerardi</i>)	4,5	Perimeter	yes	Irregular or seasonal inundation.	High. Seeds for songbirds. Food for deer	Requires full sun.
Birdfoot deervetch (<i>Lotus Corniculatus</i>)	4,5,6	Perimeter	yes	Infrequent inundation	High. Food for birds.	Full sun. Nitrogen fixer.
Blue Flag Iris (<i>Iris versicolor</i>)	2,3	Emergent	yes	Regular or permanently, up to ½ ft or saturated	Moderate. Food muskrat and wildfowl. Cover, marshbirds	Slow growth. Full sun to partial shade. Tolerates clay. Fresh to moderately brackish water.
Blue Joint (<i>Calamagrotis canadensis</i>)	2,3,4	Emergent	yes	Regular or permanent inundation up to 0.5 ft.	Moderate. Food for game birds and moose.	Tolerates partial shade
Broomsedge (<i>Andropogon virginicus</i>)	2,3	Perimeter	yes	up to 3 in.	High. Songbirds and browsers. Winter food and cover.	Tolerant of fluctuation water levels & partial shade.
Bushy Beardgrass (<i>Andropogon glomeratus</i>)	2,3	Emergent	yes	up to 1 ft.		Requires full sun.
Cardinal flower (<i>Lobelia cardinalis</i>)	4,5,6	Perimeter	yes	Some. Tolerates saturation up to 100% of season.	High. Nectar for hummingbird, oriole, butterflies.	Tolerates partial shade

Table H.5 Native Plant Guide for Stormwater Management Areas (NY)						
Plant Name	Zone	Form	Available	Inundation Tolerance	Wildlife Value	Notes
Cattail (<i>Typha sp.</i>)	2,3	Emergent	yes	up to 1 ft.	Low. Except as cover	Aggressive. May eliminate other species. Volunteer. High pollutant treatment
Coontail (<i>Ceratophyllum demersum</i>)	1	Submergent	no	yes	Low food value. Good habitat and shelter for fish and invertebrates.	Free floating SAV. Shade tolerant. Rapid growth.
Common Three-Square (<i>Scirpus pungens</i>)	2	Emergent	yes	up to 6 in.	High. Seeds, cover. Waterfowl and fish.	High metal removal.
Duckweed (<i>Lemna sp.</i>)	1,2	Submergent/ Emergent	yes	yes	High. Food for waterfowl and fish.	High metal removal.
Fowl mannagrass (<i>Glyceria striata</i>)	4,5	Perimeter	yes	Irregular or seasonal inundation	High. Food for waterfowl, muskrat, and deer.	Partial to full shade.
Hardstem Bulrush (<i>Scirpus acutus</i>)	2	Emergent	yes	up to 3 ft.	High. Cover, food (achenes, rhizomes) ducks, geese, muskrat, fish. Nesting for bluegill and bass.	Quick to establish, fresh to brackish. Good for sediment stabilization and erosion control.
Giant Burreed (<i>Sparganium eurycarpum</i>)	2,3	Emergent	rare	Regular to permanently inundated. up to 1 ft.	High. Food (seeds, plant) waterfowl, beaver & other mammals. Cover for marshbirds, waterfowl.	Rapid spreading. Tolerates partial sun. Good for shoreline stabilization.. Salinity <0.5 ppt
Lizard's Tail (<i>Saururus cernuus</i>)	2	Emergent	yes	up to 1 ft.	Low, except wood ducks.	Rapid growth. Shade tolerant
Long-leaved Pond Weed (<i>Potamogeton nodosus</i>)	1,2	Rooted submerged aquatic	yes	up to 1-6 ft. depending on turbidity	High. Food (seeds, roots) waterfowl, aquatic fur-bearers, deer, moose. Habitat for fish	Rapid spread. Salinity <0.5 ppt. Flowers float on surface, Aug.-Sept.

Table H.5 Native Plant Guide for Stormwater Management Areas (NY)						
Plant Name	Zone	Form	Available	Inundation Tolerance	Wildlife Value	Notes
Marsh Hibiscus (<i>Hibiscus moscheutos</i>)	2,3	Emergent	yes	up to 3 in.	Low. Nectar.	Full sun. Can tolerate periodic dryness.
Pickeralweed (<i>Pontederia cordata</i>)	2,3	Emergent	yes	up to 1 ft.	Moderate. Ducks. Nectar for butterflies.	Full sun to partial shade.
Pond Weed, Sago (<i>Potamogeton pectinatus</i>)	1	Submergent	yes	yes	Extremely high. Waterfowl, marsh and shorebirds.	Removes heavy metals.
Redtop (<i>Agrostis alba</i>)	3,4,5	Perimeter	yes	Up to 25% of season	Moderate. Rabbits and some birds.	Quickly established but not highly competitive.
Rice Cutgrass (<i>Leersia oryzoides</i>)	2,3	Emergent	yes	up to 3 in.	High. Food and cover.	Full sun although tolerant of shade. Shoreline stabilization.
Sedges (<i>Carex spp.</i>)	2,3	Emergent	yes	up to 3 in.	High waterfowl, songbirds.	Many wetland and upland species.
Tufted Hairgrass (<i>Deschampsia caespitosa</i>)	3,4,5	Perimeter	yes	Regular to irregular inundation.	High.	Full sun. May become invasive.
Soft-stem Bulrush (<i>Scirpus validus</i>)	2,3	Emergent	yes	up to 1 ft.	Moderate. Good cover and food.	Full sun. Aggressive colonizer. High pollutant removal.
Smartweed (<i>Polygonum spp.</i>)	2,3,4	Emergent	yes	up to 1 ft.	High. Waterfowl, songbirds. Seeds and cover.	Fast colonizer. Avoid weedy aliens such as <i>P. perfoliatum</i> .
Soft Rush (<i>Juncus effusus</i>)	2,3,4	Emergent	yes	up to 3 in.	Moderate.	Tolerates wet or dry conditions.
Spatterdock (<i>Nuphar luteum</i>)	2	Emergent	yes	up to 3 ft.	Moderate for food but high for cover.	Fast colonizer. Tolerant of fluctuating water levels.
Switchgrass (<i>Panicum virgatum</i>)	2,3,4,5,6	Perimeter	yes	up to 3 in.	High. Seeds, cover for waterfowl, songbirds.	Tolerates wet/dry conditions.

Table H.5 Native Plant Guide for Stormwater Management Areas (NY)						
Plant Name	Zone	Form	Available	Inundation Tolerance	Wildlife Value	Notes
Sweet Flag (<i>Acorus calamus</i>)	2,3	Herbaceous	yes	up to 3 in.	Low.	Tolerant of dry periods. Not a rapid colonizer. Tolerates acidic conditions.
Waterweed (<i>Elodea canadensis</i>)	1	Submergent	yes	yes	Low.	Good water oxygenator. High nutrient, copper, manganese and chromium removal.
Wild Celery (<i>Valisneria americana</i>)	1	Submergent	yes	yes	High. Food for waterfowl. Habitat for fish and invertebrates.	Tolerant of murky water and high nutrient loads.
Wild Rice (<i>Zizania aquatica</i>)	2	Emergent	yes	up to 1 ft.	High. Food for birds.	Prefers full sun
Wool Grass (<i>Scirpus cyperinus</i>)	2,3	Emergent	yes	Irregularly to seasonally inundated	Moderate. Cover, Food.	Requires full sun. Can tolerate acidic soils, drought. Colonizes disturbed areas, moderate growth.

This page is left intentionally blank

Appendix I

This page is left intentionally blank

Traditional SMP sizing criteria are based on the hydrology and climatic conditions of moderate climates. These criteria are not always applicable to cold climate regions due to snowmelt, rain-on-snow and frozen soils. This chapter identifies methods to adjust both water quality (Section I.1) and water quantity (Section I.2) sizing criteria for cold climates.

I.1 Water Quality Sizing Criteria

The water quality volume is the portion of the SMP reserved to treat stormwater either through detention, filtration, infiltration or biological activity. Base criteria developed for SMP sizing nationwide are based on rainfall events in moderate climates (e.g., Schueler, 1992). Designers may wish to increase the water quality volume of SMPs to account for the unique conditions in colder climates, particularly when the spring snowfall represents a significant portion of the total rainfall. Spring snowmelt, rain-on-snow and rain-on-frozen ground may warrant higher treatment volumes. It is important to note that **the base criteria required by a region must always be met**, regardless of calculations made for cold climate conditions.

Figure I.1 Increased Water Quality Volume in Cold Climates

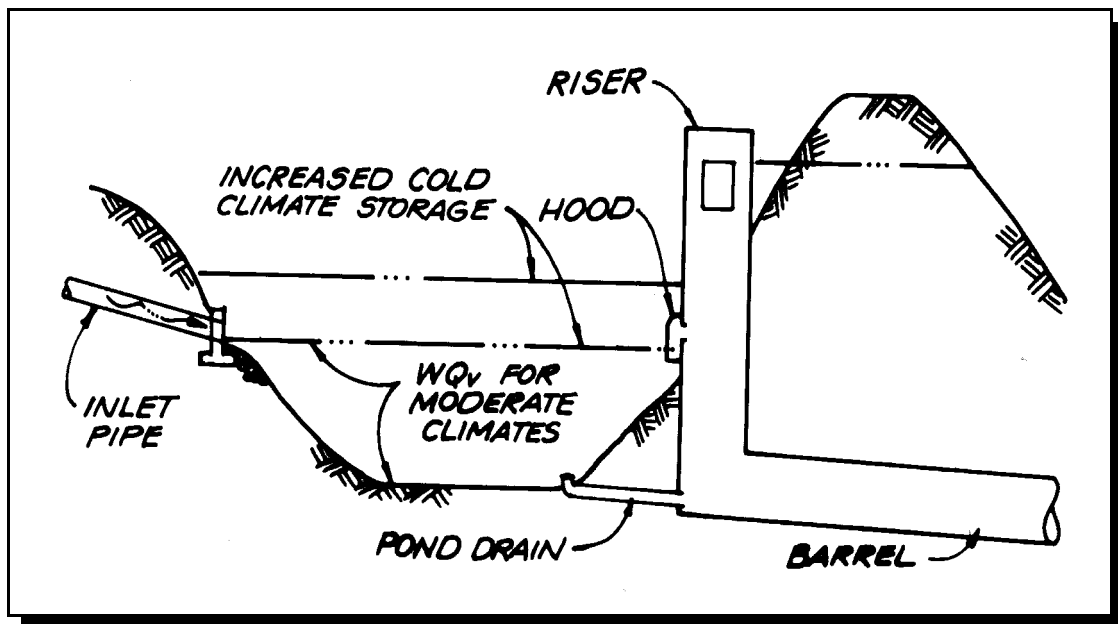

The goal of treating 90% of the annual pollutant load (Schueler, 1992), can be applied to snowmelt runoff and rain-on-snow events. In the following conditions, cold climate sizing may be greater than base criteria sizing:

- Snowfall represents more than 10% of total annual precipitation. This value is chosen because, at least some portion of the spring snowmelt needs to be treated in order to treat 90% of annual runoff in these conditions. Using the rule of thumb that the moisture content of snowfall has about 10% moisture content, this rule can be simplified as:
Oversize when average annual snowfall depth is greater than or equal to annual precipitation depth.
- The area is in a coastal or Great Lakes region with more than 3' of snow annually. In these regions, rain-on-snow events occur frequently enough to justify oversizing stormwater SMPs for water quality.

The following caveats apply to the sizing criteria presented in this section:

- These criteria are not appropriate for very deep snowpacks (i.e., greater than 4') because the volume to be treated would be infeasible, and often unnecessary.
- Sizing for snow storage areas is described in Appendix C.
- Snowmelt is a complicated process, with large annual variations. While the criteria presented here address the

affects of snowmelt and rain-on-snow, several simplifying assumptions are made. Where local data or experience are available, more sophisticated methods should be substituted.

1.1.1 Water Quality Volume for Snowmelt

In order to treat 90% of annual runoff volume, sizing for snowmelt events needs to be completed in the context of the precipitation for the entire year. In relatively dry regions that receive much of their precipitation as snowfall, the sizing is heavily influenced by the snowmelt event. On the other hand, in regions with high annual rainfall, storm events are more likely to carry the majority of pollutants annually. The sizing criteria for this section are based on three assumptions: 1) SMPs should be sized to treat the spring snowmelt event 2) Snowmelt runoff is influenced by the moisture content of the spring snowpack and soil moisture 3) No more than five percent of the annual runoff volume should bypass treatment during the spring snowmelt event and 4) SMPs can treat a snowmelt volume greater than their size.

- *SMPs should be sized to treat the spring snowmelt runoff event*

Snowmelt occurs throughout the winter in small, low-flow events. These events have high concentrations of soluble pollutants such as chlorides and metals, because of “preferential elution” from the snowpack (Jeffries, 1988). Although these events have significant pollutant loads, the flows are very low intensity, and generally will not affect SMP sizing decisions.

The spring snowmelt, on the other hand, is higher in suspended solids and hydrophobic elements, such as hydrocarbons, which can remain in the snowpack until the last five to ten percent of water leaves the snowpack (Marsalek, 1991). In addition, a large volume of runoff occurs over a comparatively short period of time (i.e., approximately two weeks). Most SMPs rely on settling to treat pollutants, and the pollutants carried in the spring snowmelt are more easily treated by these mechanisms. In addition, the large flow volume during this event may be the critical water quality design event in many cold regions.

- *Snowmelt runoff is influenced by the moisture content of the spring snowpack and soil moisture*

Because of small snowmelt events that occur throughout the winter, losses through sublimation, and management practices such as hauling snow to other locations, the snowpack only contains a fraction of the moisture from the winter snowfall. Thus, the remaining moisture in the snowpack can be estimated by:

$$M = 0.14(S - L_1 - L_2 - L_3) \quad \text{Equation I.1}$$

Where:

M=Moisture in the Spring Snowpack (inches)

S=Annual Snowfall (inches)

L₁, L₂ and L₃ = Losses to Hauling, Sublimation and Winter Melt, respectively.

The volume of snow hauled off site can be determined based on available information on current plowing practices. In New York, sublimation to the atmosphere is not very important

The design examples in this section use a simple “rule of thumb” approach, to estimate winter snowmelt for simplicity (Table I.1). The method assumes that winter snowmelt is influenced primarily by temperature, as represented by the average daily temperature for January. One half of the snow (adjusted for plowing and sublimation) is assumed to melt during the winter in very cold regions (Average T_{max} <25°F) and two thirds is assumed to melt during the winter in moderately cold regions (Average T_{max} <35°F). Winter snowmelt can be estimated using several methods, such as the simple degree-day method, or through more complex continuous modeling efforts.

Table I.1 Winter Snowmelt*

Adjusted Snowfall Moisture Equivalent	Winter Snowmelt (January T _{max} < 259F)	Winter Snowmelt (January T _{max} < 359F)
2"	1.0"	1.3"
4"	2.0"	2.7"
6"	3.0"	4.0"
8"	4.0"	5.3"
10"	5.0"	6.7"
12"	6.0"	8.0"

* Snowmelt occurring before the spring snowmelt event, based on the moisture content in the annual snowfall. The value in the first column is adjusted for losses due to sublimation and plowing off site.

Snowmelt is converted to runoff when the snowmelt rate exceeds the infiltration capacity of the soil. Although the rate of snowmelt is slow compared with rainfall events, snowmelt can cause significant runoff because of frozen soil conditions. The most important factors governing the volume of snowmelt runoff are the water content of the snowpack and the soil moisture content at the time the soil freezes (Granger et al., 1984). If the soil is relatively dry when it freezes, its permeability is retained. If, on the other hand, the soil is moist or saturated, the ice formed within the soil matrix acts as an impermeable layer, reducing infiltration. Section I.1.3 outlines a methodology for computing snowmelt runoff based on this principle.

- *No more than 5% of the annual runoff volume should bypass treatment during spring snowmelt* In order to treat 90% of the annual runoff volume, at least some of the spring snowmelt, on average, will go un-treated. In addition, large storm events will bypass treatment during warmer months. Limiting the volume that bypasses treatment during the spring snowmelt to 5% of the annual runoff volume allows for these large storm events to pass through the facility untreated, while retaining the 90% treatment goal.

The resulting equation is:

$$T = (R_s - 0.05R)A / 12 \quad \text{(Equation I.2)}$$

Where:

T = Volume Treated (acre-feet)

R_s = Snowmelt Runoff [See Section I.1.3]

R = Annual Runoff Volume (inches) [See Section I.1.2]

A = Area (acres)

- *SMPs can treat a volume greater than their normal size.*

Snowmelt occurs over a long period of time, compared to storm events. Thus, the SMP does not have to treat the entire water quality treatment volume computed over twenty four hours, but over a week or more. As a result, the necessary water quality volume in the structure will be lower than the treatment volume. For this manual, we have assumed a volume of ½ of the value of the computed treatment volume (T) calculated in equation I.2.

Thus,

$$WQ_v = \frac{1}{2} T \quad \text{(Equation I.3)}$$

I.1.2 Base Criteria/ Annual Runoff

The base criterion is the widely-used, traditional water quality sizing rule. This criterion, originally developed for moderate climates, represents the minimum recommended water quality treatment volume. In this manual, the runoff from a one inch rainfall event is used as the base criteria. The basis behind this sizing criteria is that approximately 90% of the storms are treated using this event. This value may vary nationwide, depending on local historical rainfall frequency distribution data. However, the one inch storm is used as a simplifying assumption. The base criteria included in this manual is chosen because it incorporates impervious area in the sizing of urban SMPs, and modifications are used nationwide. The cold climate sizing modifications used in this manual may be applied to any

base criteria, however.

Runoff for rain events can be determined based on the Simple Method (Schueler, 1987).

$$r = p(0.05 + .9I) \quad \text{(Equation I.4)}$$

Where: r = Event Rainfall Runoff (inches)

p = Event Precipitation (inches)

I = Impervious Area Fraction

Thus, the water quality volume for the base criteria can be determined by:

$$WQ_v = (0.05 + .9I) A / 12 \quad \text{(Equation I.5)}$$

Where: WQ_v = Water Quality Volume (acre-feet)

I = Impervious Fraction

A = Area (acres)

The Simple Method can also be used to determine the annual runoff volume. An additional factor, P_j , is added because some storms do not cause runoff. Assume $P_j = 0.9$ (Schueler, 1987). Therefore, annual runoff volume from rain can be determined by:

$$R = 0.9 P (0.05 + .9I) \quad \text{(Equation I.6)}$$

Where: R = Annual Runoff (inches)

P = Annual Rainfall (inches)

1.1.3 Calculating the Snowmelt Runoff

To complete water quality sizing, it is necessary to calculate the snowmelt runoff. Several methods are available, including complex modeling measures. For the water quality volume, however, simpler sizing methods can be used since the total water quality volume, not peak flow, is critical. One method, modified from Granger et al. (1984) is proposed here. Other methods can be used, particularly those adjusted to local conditions.

According to Granger et al. (1984) the infiltration into pervious soils is primarily based on the saturation of the soils prior to freezing. While saturated soils allow relatively little snowmelt to infiltrate, dry soils have a high capacity for infiltration. Thus, infiltration volumes vary between wet, moderate and dry soil conditions (Figure I.2).

Figure I.2 Snowmelt Infiltration Based on Soil Moisture

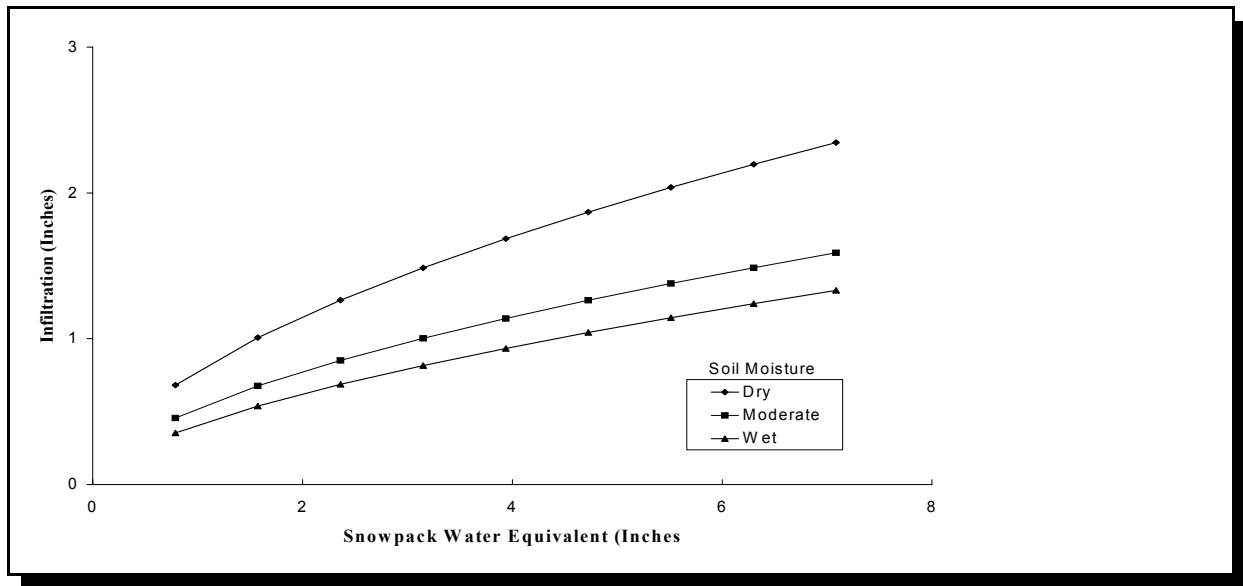

Assume also that impervious area produces 100% runoff. The actual percent of snowmelt converted to runoff from impervious areas such as roads and sidewalks may be less than 100% due to snow removal, deposition storage and sublimation. However, stockpiled areas adjacent to paved surfaces often exhibit increased runoff rates because of the high moisture content in the stockpiled snow (Buttle and Xu, 1988). This increased contribution from pervious areas off-sets the reduced runoff rates from cleared roads and sidewalks.

The resulting equation to calculate snowmelt runoff volume based on these assumptions is:

$$R_s = [\text{runoff generated from the pervious areas}] + [\text{runoff from the impervious areas}]$$

$$R_s = [(1 - I)(M - Inf)] + [(I)(1)(M)] \quad (\text{Equation I.7})$$

where:

- R_s = Snowmelt Runoff
- I = Impervious Fraction
- M = Snowmelt (inches)
- Inf = Infiltration (inches)

Sizing Example 1: Snowpack Treatment

Scenario: 50 Acre Watershed
 40% Impervious Area
 Average Annual Snowfall= 5'=60"
 Average Daily Maximum January Temperature= 20°
 Average Annual Precipitation = 30"
 20% of snowfall is hauled off site
 Sublimation is not significant
 Prewinter soil conditions: moderate moisture.

Sizing Example 1: Snowpack Treatment

Step 1: Determine if oversizing is necessary
 Since the average annual precipitaiton is only ½ of average annual snowfall depth, oversizing is needed.

Step 2: Determine the annual losses from sublimation and snow plowing.
 Since snow hauled off site is about 20% of annual snowfall, the loss from snow hauling, L_1 , can be estimated by:

$$L_1 = (0.2)(0.1)S$$

Where: L_1 = Water equivalent lost to hauling snow off site (inches)

S = Annual snowfall (inches)

0.1 = Factor to convert snowfall to water equivalent

Therefore, the loss to snow hauling is equal to:

$$L_1 = (0.2)(0.1)(60")$$

$$L_1 = 1.2"$$

Since sublimation is negligible, $L_2 = 0$

Step 3: Determine the annual water equivalent loss from winter snowmelt events
 Using the information in Step 2, the moisture equivalent in the snowpack remaining after hauling is equal to:

$$60" - 1.2" = 58.8"$$

Substituting this value into Table I.1, and interpolating, find the volume lost to winter melt, L_3 .

$$L_3 = 2.4"$$

Step 4: Calculate the final snowpack water equivalent, M

$$M = 0.1S - L_1 - L_2 - L_3 \text{ (Equation I.1)}$$

$$S = 60"$$

$$L_1 = 1.2"$$

$$L_2 = 0"$$

$$L_3 = 2.4"$$

Therefore, $M = 54.4"$

Step 5: Calculate the snowmelt runoff volume, R_s

$$R_s = (1-I)(M-Inf) + IM \text{ Equation I.7}$$

$$M = 54.4"$$

$$I = 0.4$$

$$Inf = 0.8" \text{ (From figure I.2; assume average moisture)}$$

$$\text{Therefore, } R_s = 1.9"$$

Step 6: Determine the annual runoff volume, R

Use the Simple Method to calculate rainfall runoff:

$$R = 0.9(0.05 + 0.9 * I)P \text{ (Equation I.6)}$$

$$I = 0.4$$

$$P = 30"$$

$$\text{Therefore, } R = 11"$$

Sizing Example 1: Snowpack Treatment

- Step 7:** Determine the runoff to be treated
Treatment, T should equal:

$$T = (R_s - 0.05 * R) A / 12 \quad (\text{Equation I.2})$$

$$R_s = 1.9''$$

$$R = 11''$$

$$A = 50 \text{ Acres}$$
 Therefore, T=5.6 acre-feet
- Step 8:** Size the SMP
The volume treated by the base criteria would be:

$$WQ_v = (.05 + .9 * .4)(1/12'')(50 \text{ acres}) = 1.7 \text{ acre-feet} \quad (\text{Equation I.5})$$
- For cold climates:

$$WQ_v = 1/2(T) = 2.8 \text{ acre-feet} \quad (\text{Equation I.3})$$
 The cold climate sizing criteria is larger, and should be used to size the SMP.

I.1.4 Rain-on-Snow Events

For water quality volume, an analysis of rain-on-snow events is important in coastal regions. In non-coastal regions, rain-on-snow events may occur annually but are not statistically of sufficient volume to affect water quality sizing, especially after snowpack size is considered. In coastal regions, on the other hand, flooding and annual snowmelt are often driven by rain-on-snow events (Zuzel et al., 1983). Nearly 100% of the rain from rain-on-snow events and rain immediately following the spring melt is converted to runoff (Bengtsson, 1990). Although the small rainfall events typically used for SMP water quality do not produce a significant amount of snowmelt (ACOE, 1956), runoff produced by these events is high because of frozen and saturated ground under snow cover.

Many water quality volume sizing rules are based on treating a certain frequency rainfall event, such as treating the 1-year, 24-hour rainfall event. The rationale for treating 90% of the pollutant load (Schueler, 1992) can also be applied to rain-on-snow events, as shown in the following example.

Sizing Example 2: Rain-on-Snow

- Step 1:** Develop a rain-on-snow data set.
Find all the rainfall events that occur during snowy months. Rainfall from December through April were included. Please note that precipitation data includes both rainfall and snowfall, and only data from days without snowfall should be included. Exclude non-runoff-producing events (less than 0.1"). Some of these events may not actually occur while snow is on the ground, but they represent a fairly accurate estimate of these events.
- Step 2:** Calculate a runoff distribution for rain-on-snow events
Since rain-on-snow events contribute directly to runoff, the runoff distribution is the same as the precipitation distribution in Figure I.3.

Sizing Example 2: Rain-on-Snow

Figure I.3 Rainfall Distribution for Snowy Months

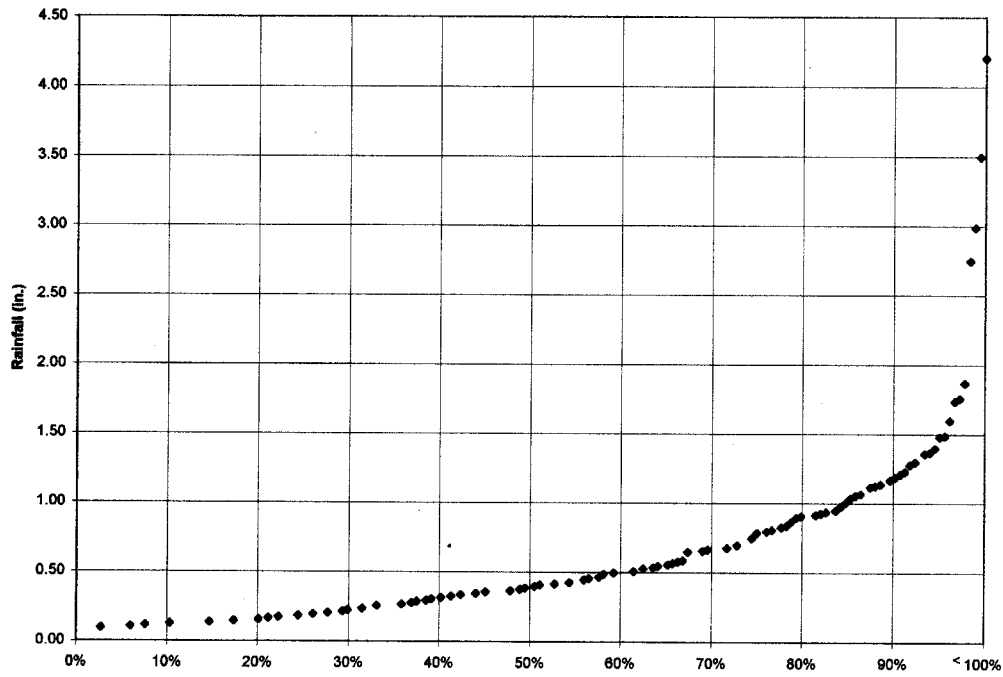

Step 3:

Calculate a rainfall distribution for non-snow months. Develop a distribution of rainfall for months where snow is not normally on the ground. The rainfall distribution for May through November is included in Figure I.4.

Sizing Example 2: Rain-on-Snow

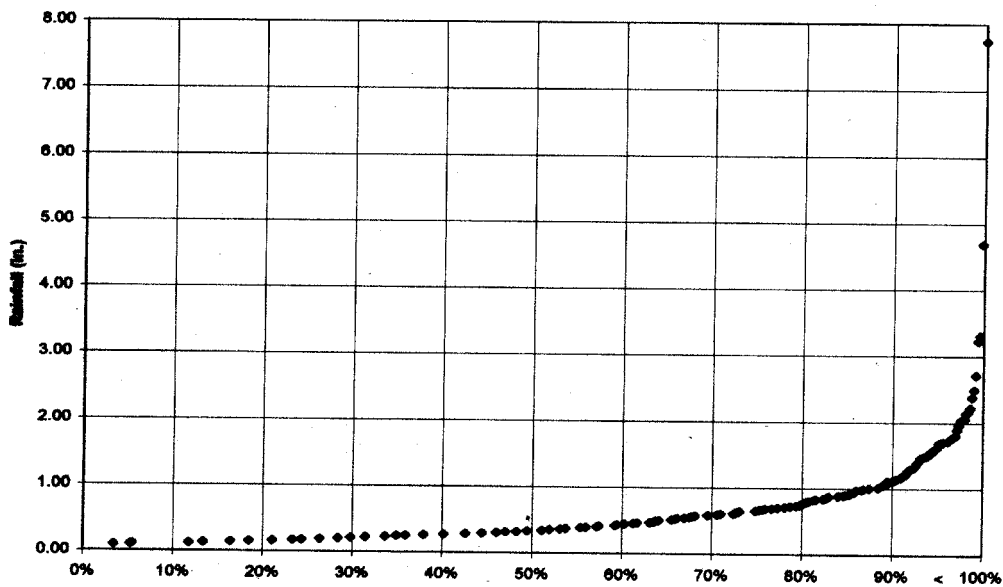

Figure

Rainfall Distribution for Non-Snowy Months

I.4

Step 4:

Calculate the runoff distribution for non-snow months.

Use a standard method to convert rainfall to runoff, particularly methods that are calibrated to local conditions. For this example, use the Simple Method. Runoff is calculated as:

$$r = (0.05 + 0.9 I) p \quad \text{(Equation I.4)}$$

For this example, $I = 0.3$ (30% impervious area), so:

$$r = 0.32 p$$

The runoff distribution for non-snow months is calculated by multiplying the rainfall in Figure I.4 by 0.32.

Step 5:

Combine the runoff distributions calculated in Steps 2 and 4 to produce an annual runoff distribution. The resulting runoff distribution (Figure I.5) will be used to calculate the water quality volume.

Sizing Example 2: Rain-on-Snow

Figure I.5 Annual Runoff Distribution

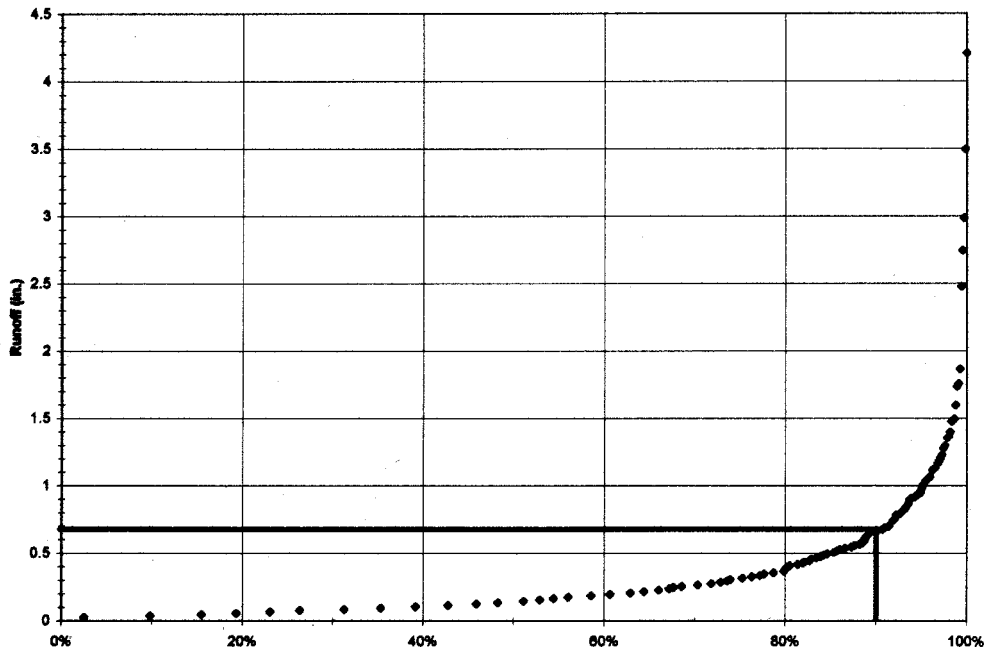

Step 6:

Size the SMP.

In this case, use the 90% frequency runoff event (Figure I.4), or 0.65 watershed inches. This value is greater than the base criteria of 0.32 watershed inches (1" storm runoff). Therefore, the greater value is used.

$$WQ_v = (0.65 \text{ inches}) (1 \text{ foot}/12 \text{ inches}) (50 \text{ acres}) = 2.7 \text{ acre-feet}$$

References

Army Corps of Engineers (ACOE), North Pacific Division. 1956. Snow Hydrology, Summary Report of the Snow Investigations. Portland, OR.

Bengtsson, L. 1990. Urban Snow Hydrology. *Proceedings of an International Conference on Urban Hydrology Under Wintry Conditions*. Narvik, Norway.

Buttle, J. and F. Xu. 1988. Snowmelt Runoff in Suburban Environments. *Nordic Hydrology*, 19:19-40.

Granger, R., D. Gray and D. Dyck. 1984. Snowmelt Infiltration to frozen Prairie Soils. *Canadian Journal of Earth Science*, 21:669-677

Jeffries, D. 1988. Snowpack Release of Pollutants. National Water Research Institute, Report No. 88-06. Burlington, ON, Canada.

Marsalek, J. 1991. Urban Drainage in Cold Climates: Problems, Solutions and Research Needs. IN: *New Technologies in Urban Drainage*. Elsevier Applied Science. New York, N.Y.

Schueler, T. 1992. *Design of Stormwater Wetland Systems*. Metropolitan Washington Council of Governments. Washington, DC.

Schueler, T. 1987. *Controlling Urban Runoff: A Practical Manual for Planning and Designing Urban Best Management Practices*. Metropolitan Washington Council of Governments. Washington, D.C.

Zuzel, J., R. Greewalt, and R.R. Allmaras. 1983. Rain on Snow: Shallow, Transient Snowpacks with Frozen Soils. *Proceedings of the Western Snow Conference*. pp. 67-75.

This page is left intentionally blank

Appendix J

This page is left intentionally blank

**Distributed Runoff Control Methodology
Pond Outlet Structure Design Example**

The following design example illustrates a step-by-step methodology for the design of a weir for the control of in-stream erosion potential using a Stormwater Management (SWM) wet pond design based on the Distributed Runoff Control (DRC) approach. The DRC approach incorporates boundary material composition and its sensitivity to erosion (entrainment and transport) into the design protocol. The boundary materials are characterized at the point of maximum boundary shear stress on the bed and the point of secondary maximum boundary shear stress on the bank. By examining the channel at selected sites downstream of the SWM facility the DRC protocol provides a pseudo 3-dimensional assessment of the impact of development and the SWM facility on the receiving channel.

This design example involves 5 Steps as listed in Table J.1.

Table J.1 Overview of Key Steps in the DRC Design Approach	
1)	Determine the “stability” and “mode-of-adjustment” of the receiving channel
2)	Complete a Diagnostic Geomorphic Survey of the receiving channel
3)	Determine channel sensitivity to an alteration in the sediment-flow regime
4)	Approximate the elevation-discharge curve for the pond.
5)	Size the DRC weir

Step 1. Determine Channel “Stability” and “Mode-of-Adjustment”

Channel stability is determined using a Rapid Geomorphic Assessment (RGA) of the channel downstream of the outlet of the proposed Stormwater Management (SWM) pond. The RGA protocol involves the identification of the presence of in-stream features resulting from a variety of geomorphic processes to provide a semi-quantitative assessment of a stream's stability and mode-of-adjustment. The processes are represented by four Factors: aggradation (AF), widening (WF), downcutting (DF), and planimetric form adjustment (PF)). Each Factor is composed of 7 to 10 indices for which a “present” or “absent” response is required. The total number of “present” or “yes” responses is summed and divided by the total number of responses (both “yes” and “no”) to derive a value for each Factor. An index that is not relevant is not assigned a response. An example of an RGA Form is provided in Table J.2.

A Stability Index (SI) value is determined from the Factor values using the following equation:

$$SI = \frac{\{AF + DF + WF + PF\}}{m}, \dots\dots\dots [J.1]$$

where ‘m’ is the number of Factors (typically 4 for alluvial streams).

Table J.2 Rapid Geomorphic Assessment Form					
FORM/ PROCESS	GEOMORPHIC INDICATOR		PRESENT		FACTOR VALUE
	No.	Description	No	Yes	
Evidence of Aggradation (AI)	1	Lobate bar	1		1/7=0.143
	2	Coarse material in riffles embedded		1	
	3	Siltation in pools	1		
	4	Medial bars	1		
	5	Accretion on point bars	1		
	6	Poor longitudinal sorting of bed materials	1		
	7	Deposition in the overbank zone	1		
Evidence of Degradation (DI)	1	Exposed bridge footing(s)	-	-	2/6=0.333
	2	Exposed sanitary/storm sewer/pipeline/etc.	-	-	
	3	Elevated stormsewer outfall(s)	-	-	
	4	Undermined gabion baskets/concrete aprons/etc.	-	-	
	5	Scour pools d/s of culverts/stormsewer outlets	1		
	6	Cut face on bar forms	1		
	7	Head cutting due to knick point migration	1		
	8	Terrace cut through older bar material		1	
	9	Suspended armor layer visible in bank		1	
	10	Channel worn into undisturbed overburden/bedrock	1		
Evidence of Widening (WI)	1	Fallen/leaning trees/fence posts/etc.		1	3/10=0.30
	2	Occurrence of Large Organic Debris		1	
	3	Exposed tree roots		1	
	4	Basal scour on inside meander bends	1		
	5	Basal scour on both sides of channel through riffle	1		
	6	Gabion baskets/concrete walls/armor stone/etc. out flanked	1		
	7	Length of basal scour >50% through subject reach	1		
	8	Exposed length of previously buried pipe/cable/etc.	1		
	9	Fracture lines along top of bank	1		
	10	Exposed building foundation	1		
Evidence of Planimetric Form Adjustment (PI)	1	Formation of cuto(s)	1		0/7=0
	2	Evolution of single thread channel to multiple channel	1		
	3	Evolution of pool-riffle form to low bed relief form	1		
	4	Cutoff channel(s)	1		
	5	Formation of island(s)	1		
	6	Thalweg alignment out of phase with meander geometry	1		
	7	Bar forms poorly formed/reworked/removed	1		
STABILITY INDEX (SI) = (AI+DI+WI+PI)/m				SI=	0.19

The Stability Index (SI) provides an indication of the stability of the creek channel at a given time based on the guidelines provided in Table J.3. The SI Value, however, does not differentiate between current and past disturbances.

Table J.3 Interpretation of the RGA Stability Index Value		
Stability Index Value	Stability Class	Description
0.0<SI<0.25	Stable	Metrics describing channel form are within the expected range of variance (typically accepted as one standard deviation from the mean) for stable channels of similar type
0.25<SI<0.4	Transitional	Metrics are within the expected range of variance as defined above but with evidence of stress
0.4<SI<1.0	In Adjustment	Metrics are outside of the expected range of variance for channels of similar type.

The guidelines presented in Table J.3 for the interpretation of the SI Value will vary with the field experience and the bias of the observer. The SI Values however, have been shown to be consistent between observers indicating that the protocol, once calibrated to the observer provides a reliable means of screening the channel for stability and mode-of-adjustment.

The RGA protocol is applied to channel segments of two meanders in length or the equivalent of 20 bankfull channel widths (the width of the channel at the geomorphically dominant discharge, recurrence interval of between 1 and 2 years or 1.5 years on average).

The segment chosen for application of the RGA assessment is selected to be representative of the morphology of the channel for some distance up and downstream of the surveyed segment. That is, the parameters defining channel cross-section and plan form (e.g. width, depth, meander wavelength, etc.) are within a consensual level of variance for this reach of channel. An acceptable level of variance is typically defined as within one standard deviation of the mean. These reaches are referred to as being of “like” morphology. Since the morphology of the channel will vary in the longitudinal direction with changes in flow, slope, physiography, etc., it will be necessary to re-apply the RGA protocol where the parameters characterizing the morphology of the channel have changed beyond the consensual level of variance from the previous survey reach. In this manner the channel is divided into a series of reaches of “like” morphology.

Having determined the length of the survey reach, the longitudinal profile can be plotted from topographic mapping as illustrated in Figure J.1 (Topo). Examination of Figure J.1 (topographic map data) suggests that the channel can be differentiated into three distinct reaches. In the first reach (length $L=146$ ft, the channel has an average slope of $S=0.00385$ ft/ft and a meander-pool-riffle morphology. In the middle reach ($L\approx 356$ ft; $S\approx 0.0142$ ft/ft) the channel has cascade morphology. The third reach ($L\approx 258$ ft; $S\approx 0.00794$ ft/ft) returns to the meander-pool-riffle form.

Land use through the study reach is homogeneous (forest) and there are no other features (e.g. bridges, dams, weirs, instream works, etc.) that would affect the hydraulic characteristics of the active channel. Consequently, a preliminary definition of “like” reaches includes the three morphologies described above.

A synoptic geomorphic survey was conducted through the subject reach with an RGA assessment completed for each of the three reaches of “like” morphology. The results of the RGA assessment for the first reach (Reach 1) are reported in Tables J.2 and J.4. Referring to Table J.2, the Stability Index (SI) value was found to be $SI=0.19$, which is less than 0.25, therefore the channel is considered to be “stable” (Table J.3).

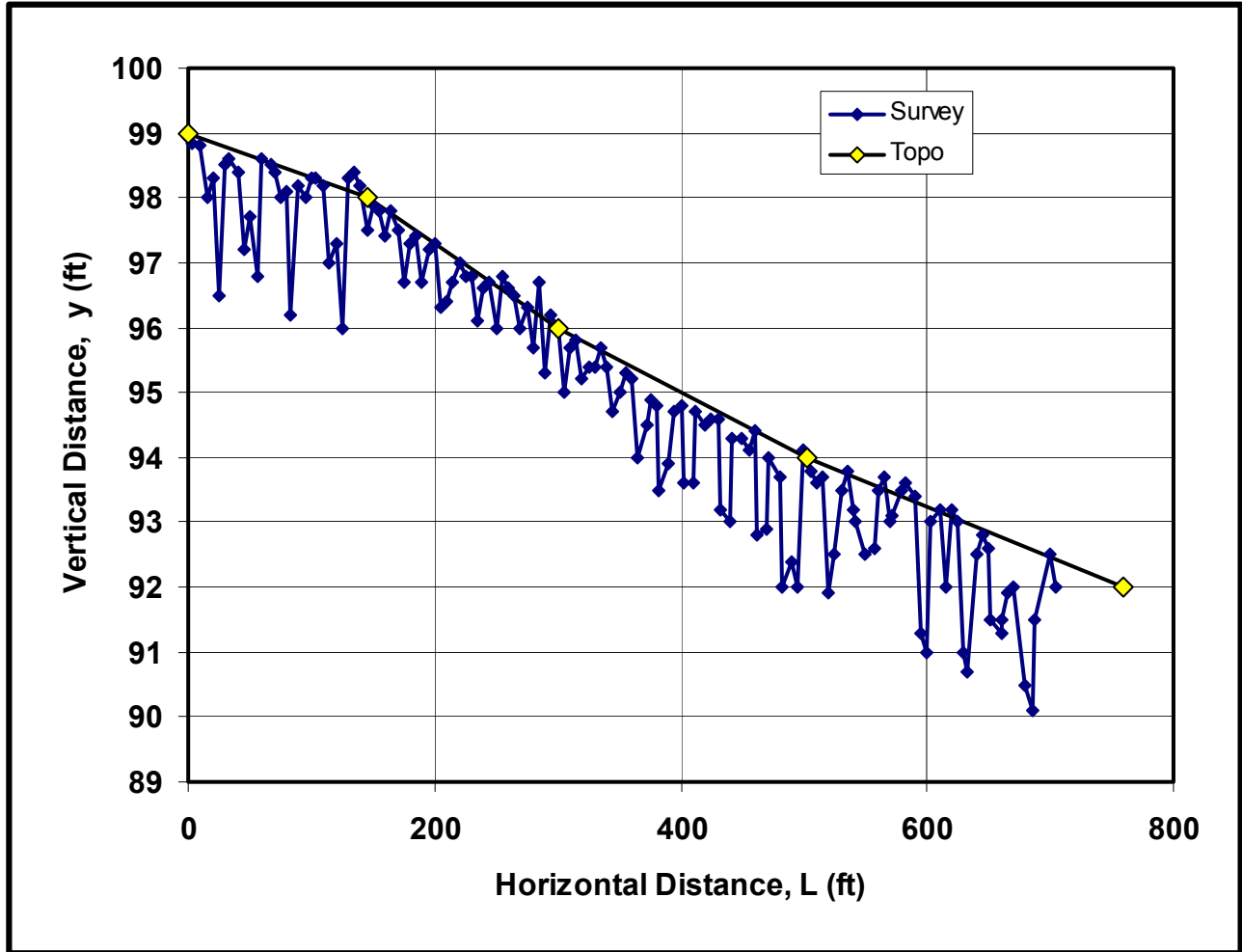

Figure J.1 Longitudinal Profile from Topographic Mapping and Field Survey of Channel Thalweg

Table J.4 Summary of Average Longitudinal Slope and Pool-Riffle Dimensions			
Parameter	Reach 1	Reach 2	Reach 3
Longitudinal Gradient, S (ft/ft)	0.00385	0.0142	0.00794
Riffle Length, LRIF (ft)	16	34	27
Pool Length, LPOL (ft)	37	10	18
Total Pool-Riffle Length, LTOT (ft)	53	44	45

Step 2. Diagnostic Geomorphic Survey

Following completion of the identification of reaches of “like” morphology and the synoptic survey to finalize the delineation of the “like” reaches, a diagnostic geomorphic survey is undertaken to characterize the morphological attributes of the channel. This information has two primary functions.

1. The optimization of the erosion control benefit of the pond; and,
2. The provision for establishing a baseline condition from which it is possible to assess the performance of the SWM measures.

A detailed diagnostic survey includes a collection of a comprehensive set of parameters to assess and evaluate stream geomorphic conditions. A complete survey is typically required when:

- a) A post-construction monitoring program is mandated; and,
- b) Data are required for the design and construction of instream works.

Only a partial diagnostic survey is needed where the above issues are not relevant to the project. The following lists those parameters required for the partial diagnostic survey:

1. In the absence of flow measurements, a field estimate of Manning’s ‘n’ value is obtained for comparison with sediment computed estimates.
2. Detailed survey of the channel cross-section, including the floodplain, to determine hydraulic geometry metrics at a so called “Master cross-section” and the relative location of bank material strata.
3. The longitudinal profile of the bed along the channel thalweg and the water surface at the time of survey over a distance of one meander wavelength or 10 bankfull widths. These data are used to determine the longitudinal gradient of the channel from riffle crest to riffle crest and to determine the dimensions of the pool-riffle complex.
4. At least one estimate of bankfull depth (the depth of flow at the dominate discharge) at the Master cross-section and all ancillary cross-sections (3 alternative methods are described in this example for illustrative purposes).
5. Bed material characteristics based on pebble counts of the bed material at a riffle crossover. These data are collected to help assess roughness coefficients, bed material resistance, and provide an alternate method for the estimation of bankfull depth.
6. Soil pits in the banks to map bank stratigraphy and to determine bank material composition using soil consistency tests (stickiness, plasticity and firmness) or particle size analysis (percent silt clay) with Atterberg Limits (Plasticity Index) for each stratigraphic unit. These data are required to help assess historic degradation or aggradation patterns and determine bank material resistance.
7. Map riparian vegetation and root zone characteristics in the soil pits for assessment of the affect of root binding on bank material resistance.

The cross-section data and bank material characterization is completed at a Master cross-section within the representative segment of each “like” reach. The Master cross-section is typically located at a riffle crossover on a straight reach between meander bends. Ancillary cross-sections are located in the lower one third of the meander bends and riffle crossover points up and downstream of the Master cross-section. Data collected at the ancillary cross-sections includes a cross-section profile (typically 7 to 9 ordinates) and estimates of bankfull stage. The longitudinal profile is collected throughout the survey segment along with characterization of plan form geometry.

Design Case: Diagnostic Geomorphic Survey

The longitudinal survey of the channel along the thalweg is presented in Figure J.1 (“Survey” data points). This profile more clearly demonstrates the differences between the three reaches as represented by slope and pool-riffle dimensions (Table J.4). Other parameter values derived from the geomorphic survey are summarized in Table J.5. These data are combined with the cross-section, soils and sediment data to generate values for key parameters as described in the following series of calculations.

The following calculations are required to determine the 3 different estimates of the dominant discharge.

Estimate of Geomorphic Referenced Dominant Discharge

1. The longitudinal data are plotted to generate estimates of the channel gradient in order of priority as follows:
 - (1) Water surface profile based on estimates of bankfull stage from the Master and ancillary cross-sections.
 - (2) Bed slope (riffle crest to riffle crest), and
 - (3) Water surface profile (dry weather flow at the time of the survey).
2. The pebble count data (length, width and breadth) are transformed into an equivalent diameter and used to generate a mass curve wherein cumulative percent finer by mass is plotted as a function of particle diameter;
3. The ϕ_{50} and ϕ_{84} particle size values (the particle diameter below which 50 and 84% of the particles are finer by mass, respectively) are determined from the mass curve;
4. Manning’s roughness coefficient is estimated at bankfull stage using:
 - (1) Standard field guides, and
 - (2) Empirical relations such as: the Strickler (1923) and Limerinos (1970) equations.
5. The cross-section ordinates collected at the Master cross-section are plotted to produce a cross-section profile and a stage-area curve;
6. The stage-area curve is combined with the longitudinal gradient (S) and the estimate of Manning’s roughness coefficient (n) to generate the stage-discharge curve for the cross-section using Manning’s equation,

$$Q = \frac{1.49}{n} AR^{(\frac{2}{3})} S^{\frac{1}{2}}, \dots \dots \dots [J.2]$$

in which Q represents the flow rate (cfs) at depth ‘y’ above the thalweg, ‘A’ is the cross-section area of the channel at depth ‘y’, ‘R’ represents the hydraulic radius at depth ‘y’ and ‘S’ is the longitudinal gradient of the channel (ft/ft). An example of a stage-discharge curve is provided in Figure J.2;

Table J.5 Summary of Hydraulic and Sediment Parameters

Reach No.	Rosgen Stream Type	Parameter									
		2 Year Flow Q _{2YR} (cfs)	W/d Ratio	Width W _{BFL} (ft)	Depth d _{BFL} (ft)	Flow Q _{BFL} (cfs)	Base B (ft)	Wetted Perimeter P (ft)			
1	C3	8.9	3.00	3.00	1.00	4.76	2.00	4.24			
2	B3	9.54	3.23	2.75	0.85	5.10	1.90	3.80			
3	C3	10.1	2.87	2.83	0.99	5.40	1.85	4.06			
Reach No.	Parameter										
	Bed Material Mean Particle Size		Area	Hydraulic Radius	Slope	Velocity	Riparian Vegetation Type				
	□ ₅₀ (in)	□ ₈₄ (in)	A _{BFL} (ft ²)	R (ft)	S (ft/ft)	v (fps)					
1	2.8	3.3	2.50	0.590	.00385	1.90	Woody				
2	5.1	7.5	1.99	0.521	.0142	2.57	Woody				
3	3.7	5.2	2.32	0.570	.00794	2.35	Woody				
Reach No.	Parameter										
	Bank Material Composition					Critical Shear Stress		Depth of Stratigraphic Unit h (ft)	Excess Boundary Shear Stress □ _{CRT} (lbs/ft ²)		
	Soil Class		Soil Consistence Test			Bank (*) □ _{CRT} (lbs/ft ²)	Bed □ _{CRT} (lbs/ft ²)		Bank	Bed	
	Class	Unit No.	X1	X2	X3	SCOR E					
1	SiLm	1	1	2	1	4		0.548	0.36<h≤1.00	0.057	-0.334
	SiSa	2	0	0	1	1	0.120		0.10<h≤0.36		
	CoGr	3	N/a	N/a	N/a	N/a			0.0<h≤0.10		
2	CoBo	1	N/a	N/a	N/a	N/a	0.573	1.206	0.39<h≤0.85	-0.016	-0.526
	GrCo	2	N/a	N/a	N/a	N/a			0.0<h≤0.39		
3	SiLm	1	2	1	3	6		0.878	0.32<h≤0.99	0.03	-0.446
	SiCl	2	2	2	2	6	0.329		0.12<h≤0.32		
	SiCl	3	2	3	2	7			0.0<h≤0.12		

(*) Least resistant lower bank stratigraphic unit corresponding to the zone of secondary maximum boundary shear stress.

- The dominant discharge (Q_{GEO}) is determined from the stage-discharge curve and field estimate of bankfull stage (d_{BFL}). For Reach 1 in this example, d_{BFL}=1.0 ft, consequently Q_{GEO}=4.76 cfs (Figure J.2). This procedure is repeated for each cross-section within the reach and the flow rate most common to all cross-sections is adopted as the geomorphic referenced estimate of the dominant discharge. If a wide disparity exists between estimates of (Q_{GEO}) than the determination of slope, Manning’s ‘n’ value and the geomorphic indicators of bankfull stage are revisited to determine if a miss-interpretation of the data or an error in calculations has occurred.

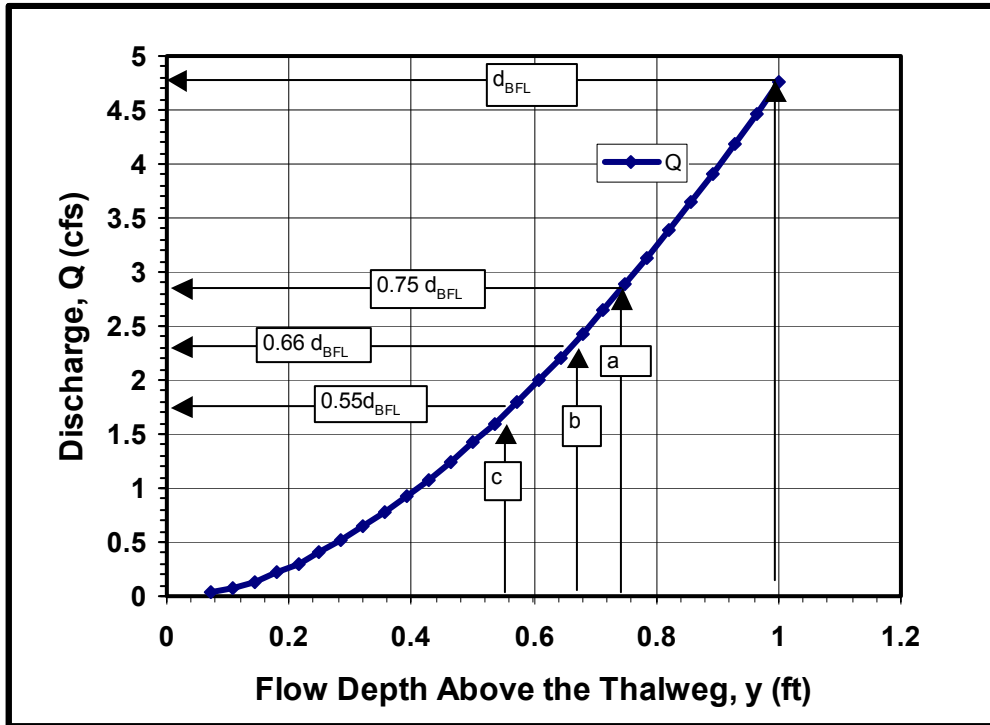

Figure J.2 Stage-Discharge Curve for Reach 1 Downstream of the Proposed Development

Estimate of Bed Material Critical Shear Stress

8. Critical shear stress is estimated for the ϕ_{84} particle size value of the bed material using procedures such as:
 - (1) The modified Shield’s equation (Vanoni, 1977), or
 - (2) Various empirical relations (from the literature) that express critical shear stress as a function of particle size, one such is Eqn J.3 proposed by Lane (1955)

$$(\tau_{CRT})_{BED} = 0.164\phi_{84}, \dots \dots \dots [J.3]$$

in which ϕ_{84} is the particle size for which 84% of the materials are finer (inches) and τ_{CRT} represents the critical shear stress (lbs/ft²). Applying Eqn, [J.3] :

$$(\tau_{CRT})_{BED} = 0.164N_{84} = 0.164 (3.34 \text{ in}) = 0.548 \text{ lbs/ft}^2$$

at the Master cross-section (Reach 1);

Estimate of Instantaneous Bed Shear Stress

9. A stage-shear stress curve is generated for the Master cross-section using DuBoy’s relation for average shear stress and a channel shape adjustment factor proposed by Lane (1955) as follows:

$$\tau_0 = k_b \rho g (d - d_p) S, \dots \dots \dots [J.4]$$

and,

$$k_b = 0.000547\left(\frac{B}{d}\right)^3 - 0.0121\left(\frac{B}{d}\right)^2 + 0.092\left(\frac{B}{d}\right) + 0.75, \dots \dots \dots [J.5]$$

in which J_0 represents the instantaneous boundary shear stress at point ‘P’ on the bed (lbs/ft s²), k_b is a channel shape adjustment factor (dimensionless; Fig. J.3), D is the density of the sediment-water mixture being conveyed by the channel (62.4 lbs/ft³), ‘g’ is acceleration due to gravity (32.2 ft/s²), ‘d’ is the depth of the flow above the thalweg (ft), d_p is the depth of flow above the thalweg at point ‘P’ (ft), ‘S’ represents the longitudinal gradient of the flow at depth ‘d’ and ‘B’ is the bottom width of the channel (assuming a trapezoidal configuration). In this design case, a mapping of the isovels through the Master cross-section indicates that the point of maximum boundary shear stress occurs at the thalweg. Since the thalweg is the deepest part of the channel, the term $d_p=0$ in Eqn. J.4. A stage-shear stress curve for Reach 1 is illustrated in Figure J.4. Note that the units for J_0 are reported in lbs/ft² to be consistent with the estimate of critical shear stress reported in Task 8. To obtain units of lbs/ft² remove ‘g’ from Eqn. J.4.

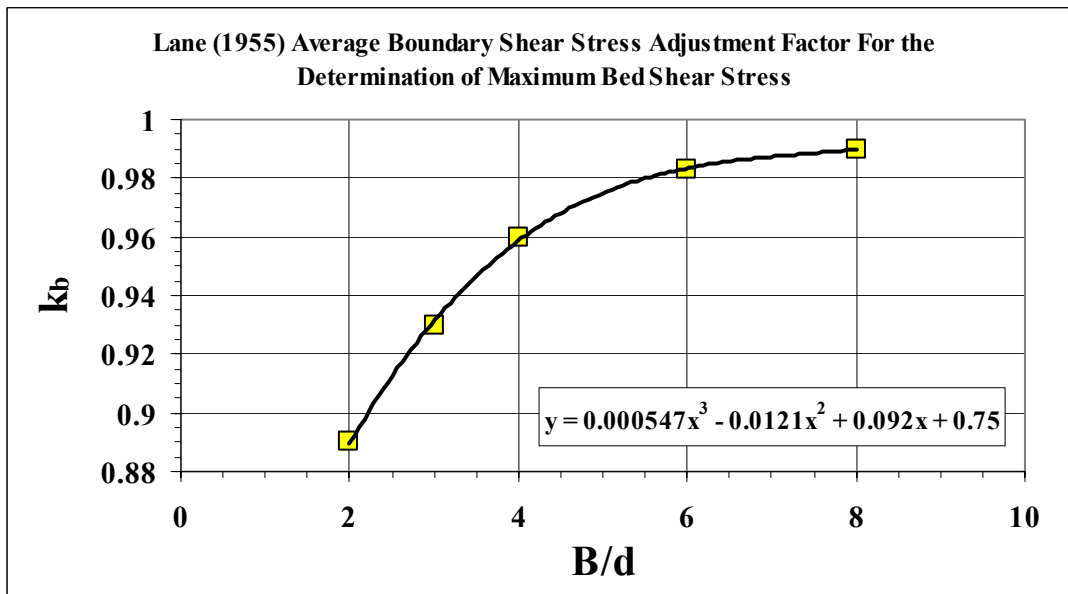

Figure J.3 Determination of k_B for the Adjustment of Average Boundary Shear Stress For Variations in Channel Shape Assuming A Trapezoidal Channel Cross-Section Configuration

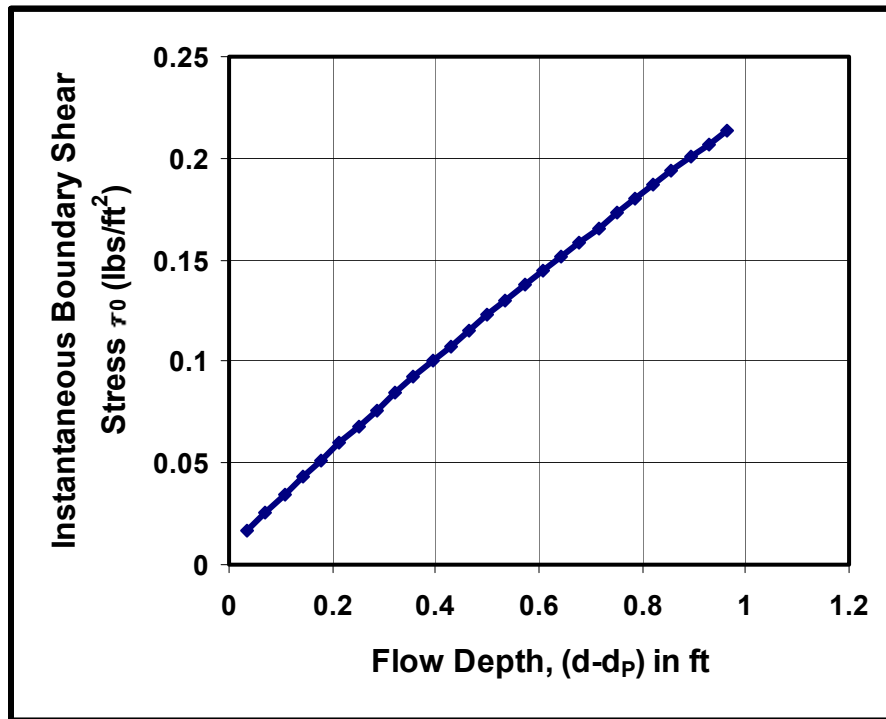

Figure J.4. Stage-Shear Stress Curve for Reach 1 (Master Cross-section): Bed Station.

Estimate the Sediment Referenced Dominant Discharge

10. The stage-shear stress curve is used to determine the depth of flow at which the boundary shear stress on the bed is equal to the critical shear stress of the N_{84} particle size fraction. This depth is transformed into an estimate of flow rate from the stage-discharge curve (Task 5 above), providing a second, independent estimate of the dominant discharge (Q_{SED}). This calculation also provides a basis for determination of the sensitivity of the bed material to an alteration in the sediment-flow regime. This assessment is described in Task 21 below;

Estimate The Flow Recurrence Interval of the Referenced Dominant Discharge

11. A flow time series is generated using:
 - (1) Flow gauge data if available, or
 - (2) A continuous hydrologic model to generate a synthetic flow time series of 6 to 13 years in length.
12. The flow time series is used to derive a flood frequency curve from which a third independent estimate of the dominant discharge (Q_{RI}) is determined as the flow having a recurrence interval between 1 and 2 years (average $RI=1.5$ years);

Finalize the Estimate of Dominant Discharge

13. The three estimates of dominant discharge are compared for consistency. If consistent (e.g. the range is equal to or less than 20% of the mean), then the mean value of the dominant discharge can be accepted with a higher degree of confidence

Step 3. Determine the Sensitivity of the Boundary Materials

A) Sensitivity of the Bed Material

14. Using the stage-shear stress relationship developed in Task 9 and the estimate of flow depth (d_{BFL} , Task 10) from the dominant discharge (Task 13), determine the boundary shear stress (J_0)_{BED} being applied to the bed at point ‘P’ at the dominant discharge. Point ‘P’ is located on the bed within the zone of maximum boundary shear stress. In this example the value of maximum instantaneous boundary shear stress at a depth of $d_{BFL} = 1.0$ ft was found to be (J_0)_{BED} = 0.214 lbs/ft² at the Master cross-section in Reach 1 (Figure J.4). Similarly, for Reaches 2 and 3 the maximum value of instantaneous boundary shear stress was found to be (J_0)_{BED} = 0.680 and 0.432 lbs/ft² respectively.
15. Compute the value of (J_e)_{BED} for the Master cross-section knowing (J_0)_{BED} and (J_{CRT})_{BED} as,

$$(\tau_e)_{BED} = (\tau_0 - \tau_{CRT})_{BED}, \dots \dots \dots [J.6]$$

in which (τ_e)_{BED} represents the effective boundary shears stress, τ_0 is the instantaneous boundary shear stress at the dominant discharge and τ_{CRT} is the critical shear stress of the bed material at point ‘P’.

16. Repeat the bed shear stress analysis for all Master cross-sections in all reaches of “like” morphology.
17. Compare the value of (J_e)_{BED} for all Master cross-sections through the study reach and select the Master cross-section for which the value of (J_e)_{BED} is greatest. The reach represented by the Master cross-section having the highest value of (J_e)_{BED} is referred to as the “Control Reach”.

In this example, effective boundary shear stress on the bed was found to range from between -0.526 and -0.334 (Table J.5). The negative values infer that the channel bed is armored and the bed material is mobile under flood flow events in excess of the dominant discharge. However, of the three Master cross-sections the value of (J_e)_{BED} was greatest for Reach 1, consequently, Reach 1 was identified as the “Control Reach”.

B) Sensitivity of the Bank Material

18. The bank material for the “Control Reach” is classified according to soil type for each stratigraphic unit using:
 - (1) Soil consistency tests; or
 - (2) Particle size analysis and Atterberg Limits.

In this example the bank materials were mapped and differentiated into stratigraphic units as summarized for the three reaches in Table J.5. The soil consistency test results determined using standard soil classification guidelines (as quantified by MacRae, 1991)), are summarized below and reported in Table J.5.

 - i) Assign a value for the stickiness of the material, e.g. not sticky, (X1=0) to extremely sticky (X1=4),
 - ii) Assign a value for the plasticity of the material, e.g. not plastic (X2=0) to extremely plastic (X2=4),
 - iii) Assign a value for the firmness of the material, e.g. loose, no structure (X3=0) to

stiff (X4=4).

- (3) Sum the consistency test values,

$$SCORE = \sum_{i=1}^3 x_i , \dots \dots \dots [J.7]$$

in which SCORE represents the sum of the values assigned for stickiness, plasticity and firmness.

19. Construct stage-shear stress curves for selected bank stations approximated by 0.25d_{BFL}, 0.33d_{BFL}, 0.4d_{BFL}. More than one bank station may be required in a stratigraphic unit depending upon the thickness of the unit. The curves may be approximated as follows:

$$\tau_0 = k_s (\rho g (d - d_p) S) , \dots \dots \dots [J.8]$$

in which k_s is a correction factor for points on the channel bank determined as a function of channel shape (see Eqn. J.9, Figure J.5), 'd' is the depth of flow (ft), D is the density of water (62.4 lbs/ft³), 'g' is acceleration due to gravity (32.2 ft/s²) and d_p is the depth of flow at the elevation of the boundary station (ft).

$$k_s = 0.7236 \left(\frac{B}{d} \right)^{0.0241} , \dots \dots \dots [J.9]$$

in which B is the channel bottom (ft) width and 'd' is the depth of flow (ft). Note, to obtain units of lbs/ft² remove the constant 'g' from Eqn. J.8.

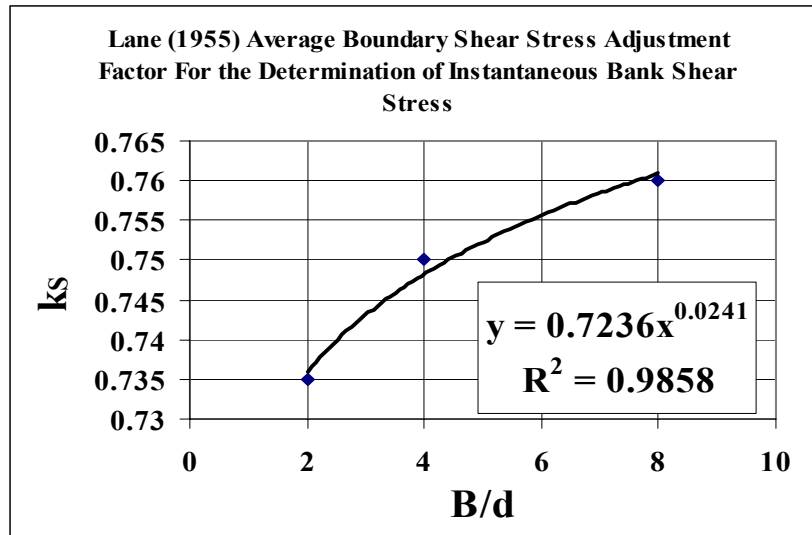

Figure J.5 Adjustment Factor k_s for Bank Shear Stress For Channels Approximating a Trapezoidal Shape

20. Estimate the critical shear stress (J_{CRT}) within each stratigraphic unit using available empirical relationships. These relations are typically based on percent silt and clay content, degree of compaction, particle size (Vanoni, 1977) or the SCORE value (MacRae, 1991);
21. Compute the excess boundary shear stress for each bank station at a flow depth of between 0.6 and 0.75 feet by reading the boundary shear stress off the stage-shear stress curve for each boundary station and subtracting the critical shear stress as described in DuBoy’s relation,

$$(\tau_e)_{BNK} = (\tau_0 - \tau_{CRT})_{BNK} \dots\dots\dots [J.10]$$

in which $(\tau_e)_{BNK}$ represents the excess boundary shear stress (lbs/ft²) at the selected boundary station (P), τ_0 is the instantaneous boundary shear stress (lbs/ft²) at any specified depth of flow at point P and τ_{CRT} represent the critical shear stress (lbs/ft²) of the boundary material at point P.

22. Compare the estimates of excess boundary shear stress $(J_e)_{BNK}$ at each bank station and select that station having the highest value of $(J_e)_{BNK}$ as the bank station controlling bank response (controlling stratigraphic unit) to a change in the flow regime. Using the guidelines presented in Table J.6 determine channel sensitivity to an alteration in the sediment-flow regime and the corresponding Over Control (OC) curve and Inflection Point

Table J.6 General Guidelines for the Application of the DRC Approach Based on Bank Material Sensitivity Using SCORE Values								
BANK SENSITIVITY		BED SENSITIVITY			DRC PARAMETERS			
Excess Shear Stress $(J_e)_{BED}$	Sensitivity Class	Excess Shear Stress $(J_e)_{BNK}$	Bank Resistance		Sensitivity Class	Over Control Multiplier R_{OC}	Inflection Point	
			Soil Class	SCORE				
<0	L	<0	Very Stiff	N/a	L	1.0 - 0.9	a	
		≈0	Stiff	10-12	ML	0.9 - 0.7	a	
			Firm	7-9	M	0.7 - 0.5	b	
			Soft	≤6	H	0.5 - 0.2	c	
		>0	N/a				0.5 - 0.2	c
≈0	ML	<0	N/a			0.9 - 0.7	a	
		≈0	Stiff	10-12	ML	0.9 - 0.7	a	
			Firm	7-9	M	0.7 - 0.5	b	
			Soft	≤6	H	0.5 - 0.2	c	
		>0	N/a				0.5 - 0.2	c
	M	<0	N/a			0.7 - 0.5	b	
		≈0	Stiff	N/a		0.7 - 0.5	b	
			Firm	7-9	M	0.7 - 0.5	b	
			Soft	≤6	H	0.5 - 0.2	c	
		>0	N/a				0.5 - 0.2	c
	H	N/a				0.5 - 0.2	c	
	>0	H	N/a				0.5 - 0.2	c

The multiplier (R_{OC}) in Table J.6 is used in the following manner:

- a) The 2 year peak flow attenuation technique is used to derive the stage-discharge curve for the erosion control component of the SWM pond.
- b) A multiplier of unity is equivalent to the traditional 2-year peak flow attenuation approach.
- c) The multiplier is used to adjust the 2-year stage-discharge curve to account for differences in the erodability of the boundary materials. The adjustment is performed by multiplying each ordinate of the stage-discharge curve by R_{OC} . For stiff materials, the multiplier approaches unity ($R_{OC} \rightarrow 1.0$). For very sensitive materials, the multiplier is between 0.2 and 0.3, which is equivalent to 80%OC to 70%OC respectively.

Bank materials may be grouped according to the SCORE value if the soil consistency tests apply (i.e. fine-grained material with few stones). For coarse-grained materials, resistance can be determined from observation of bank erosion following a high flow event. As an alternative the resistance of the coarse-grained stratigraphic unit can be inferred from bank form and shear stress distribution through comparison with adjoining strata of fine-grained material.

Finally, relations expressing critical shear stress as a function of particle size are available in the literature. Many of these relations were derived from flume experiments using disturbed material that has been re-compacted. These relations tend to underestimate the resistance of the material as it is observed in the field. Consequently, these relations should be employed with caution or corrected to account for root binding, imbrication, compaction and structurization.

Step 4. Approximate the Elevation-Discharge Curve For the DRC Pond.

The DRC outflow control structure can be constructed as set of pipes or nested weirs. This design example is for a nested, sharp crested weir.

Determine the stage-discharge curve for the flow rate having a recurrence interval of 2 years for the baseline land use condition. For this example, the baseline condition is the reforested land use scenario. The flow having a recurrence interval 2 years was determined previously as between 8.9 and 10.1 cfs for Reaches 1 through 3 respectively (Table J.5).

Construct the 2 year stage-discharge curve using an equation for sharp crested weirs with end contractions:

$$Q = C_e L_e h_e^{\left(\frac{3}{2}\right)}, \dots \dots \dots [J.11]$$

in which, ‘Q’ represents the rate of flow (cfs), ‘C_e’ is the effective weir coefficient (C=3.19, Brater and King, 1982), L_e is the effective length of the weir (ft) and ‘h_e’ is the effective depth of flow above the weir crest (ft). Set the invert of the weir at 628.0 ft. The terms L_e, C_e and h_e are adjusted to account for losses due to end contractions (Brater and King, 1982). In this illustration it is assumed that the stage-volume curve has already been derived and that the approximate head at Q_{BFL}=8.9 cfs is h=2.25 ft.

Re-arranging Eqn. J.11 and solving for ‘L_e’ at Q=(Q_{2YR})_{PRE}=8.9 cfs yields,

$$L_e = \frac{Q}{C_e h_e^{\left(\frac{3}{2}\right)}} = \frac{8.9}{3.19(2.25)^{\left(\frac{3}{2}\right)}} = 0.83\text{ft} \dots \dots \dots [J.12]$$

Compute the stage-discharge curve for the 2-year weir using Eqn. J.11 as illustrated in Figure J.6 (Q_{2YR}, curve AB. This stage-discharge curve represents the rating curve for the 2-year post- to pre-development peak flow attenuation approach.

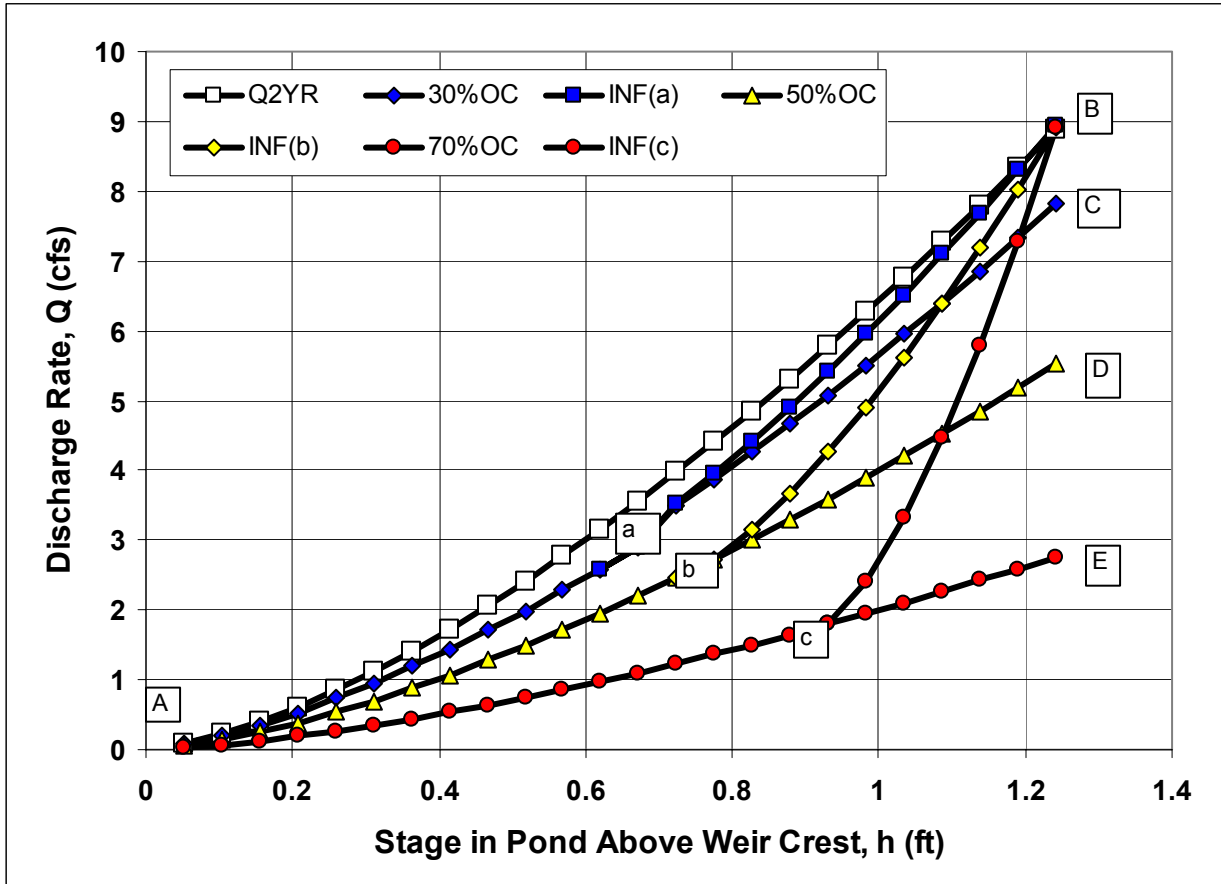

Figure J.6. The 2 Year Peak Flow Attenuation and DRC Rating Curves for 30%OC, 50%OC and 70%OC

Construct the DRC stage-discharge curve as follows:

- Determine the level of OC control and the inflection point from Table J.6.
 - Since $(J_e)_{BED} < 0$ (Table J.5) then the bed is classified as “Low” sensitivity (shaded boxes in the first two columns of Table J.6);
 - The value of $(J_e)_{BNK} > 0$ consequently, Row 3 of Column 3 (shaded box in Table J.6) was selected;
 - The bank material was classified as soft (SCORE=1), consequently, the 4th Row of Column 4 was chosen providing a range of R_{OC} between 0.5 and 0.2 with an inflection point at “c”. In this case $R_{OC}=0.3$ was selected in accordance with the guidelines in Table J.6. Note: 70%OC means that the multiplier for the 2 year curve is $R_{OC}=0.3$
 - The 70%OC curve (designated as curve AE in Figure J.6) is created by multiplying the ordinance of the 2 year stage-discharge curve (Q_{2YR} in Figure J.6) by the multiplier $R_{OC}=0.3$.
 - The inflection point (c) is determined using the guidelines provided in Table J.7.

Table J.7 Guidelines For Determination of the Flow Rate for the DRC Curve Inflection Point (Reach 1)					
Inflection Point	Ratio of Inflection Point Depth to Bankfull Depth d_i/d_{BFL} (dim)	Bankfull Depth d_{BFL} (ft)	Inflection Point Depth d_i (ft)	Dominant Discharge Q_{BFL} (cfs)	Flow Rate at Inflection Point Q_i (cfs)
a	.75	1.0	.75	4.76	2.88
b	.67		.67		2.30
c	.55		.55		1.74

The point $d_c=0.55$ ft, $d_{BFL}=1.0$ ft, characterize the Control Reach, consequently the ratio,

$$\frac{d_c}{d_{BFL}} = \frac{0.55 \text{ ft}}{1.0 \text{ ft}} = 0.55, \dots \dots \dots [J.12]$$

- The flow rate at $d_c/d_{BFL}=0.55$ was estimated from Figure J.6 to be $Q_c=1.74$ cfs.
- Point (c) can be located on curve AE at a flow corresponding to $Q_c=1.74$ cfs.
- The DRC stage-discharge curve follows the curve A(c)B in Figure J.6. For the purpose of illustration, the stage-discharge curves for 30%OC (inflection point (a)) and 50%OC (inflection point (b)) are also provided in Figure J.6.

Step 5. Sizing the DRC Weir

After establishing the DRC stage-discharge curve the next step is to size the DRC weir. This is done using a nested weir configuration as illustrated in Figure J.7. The equation for the nested weir can be approximated from Eqn. J.14 for sharp crested weirs as,

$$Q = \left(C_e L_e h_e^{\left(\frac{3}{2}\right)} \right)_{INSET} + \left(C_e (L_e^* - L_e) (h_e^* - h_e)^{\left(\frac{3}{2}\right)} \right), \dots \dots \dots [J.14]$$

in which Q represents the discharge from the nested weir, ‘ C_e ’ is a coefficient (3.19) adjusted to account for end contractions, L_e is the length of the inset weir, h_e represents the height of the inset weir where $0 \leq h_e \leq h_2$ (h_2 represents the total height of the nested weir) and h_e^* is the depth of flow through the nested weir above the inset weir ($h_e \leq h_e^* \leq h_2$).

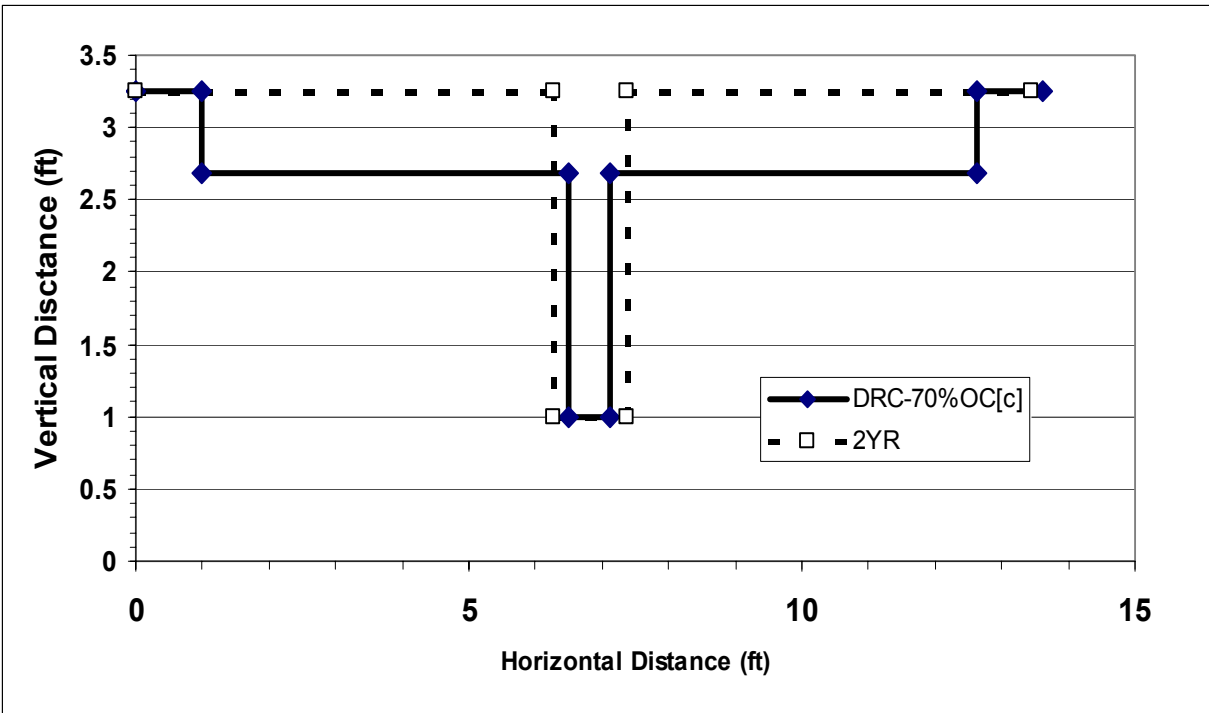

Figure J.7 Comparison of the 70% OC DRC Weir with Inflection Point at [c] and the Traditional 2-year Peak Flow Attenuation Weir

Solving Eqn. D.14 for results in the dimensions and flow values reported in Table J.8.

Table J.8. Summary of Dimensions and Flow Characteristics For a Nested DRC Weir: Reach 1				
Parameter	DRC Weir			2 Year Weir
	Inflection Point (a)	Inflection Point (b)	Inflection Point (c)	
L_e (ft)	1.77	1.00	0.62	N/A
h_e (ft)	0.67	0.78	0.93	
Q_i at h_e (cfs)	2.89	2.21	1.74	
L_e^* (ft)	0.80	4.32	11.0	0.83
h_2 (ft)	2.25			
Q at h_2 (cfs)	8.94			

Parameters in Table J.8 are defined in the preceding text.

Note: the weir dimensions for DRC stage discharge curves 30%OC (inflection point ‘a’) and 50%OC (inflection point ‘b’) are provided for comparison with the selected option (inflection point ‘c’).

This page is left intentionally blank

Appendix K

This page is left intentionally blank

Miscellaneous Design Schematics for Compliance with Performance Criteria

- Figure K-1: Trash Rack for Low Flow Orifice
- Figure K-2: Expanded Trash Rack Protection for Low Flow Orifice
- Figure K-3: Internal Control for Orifice Protection
- Figure K-4: Observation Well for Infiltration Practices
- Figure K-5: On-line Versus Off-line Schematic
- Figure K-6: Isolation/Diversion Structure
- Figure K-7: Half Round CMP Hood
- Figure K-8: Half Round CMP Weir
- Figure K-9: Concrete Level Spreader
- Figure K-10: Baffle Weir for Cold Climates
- Figure K-11: Hooded Outlet with Hood Below Ice Layer
- Figure K-12: Shallow Angle Trash Rack to Prevent Icing

Figure K.1 Trash Rack Protection for Low Flow Orifice

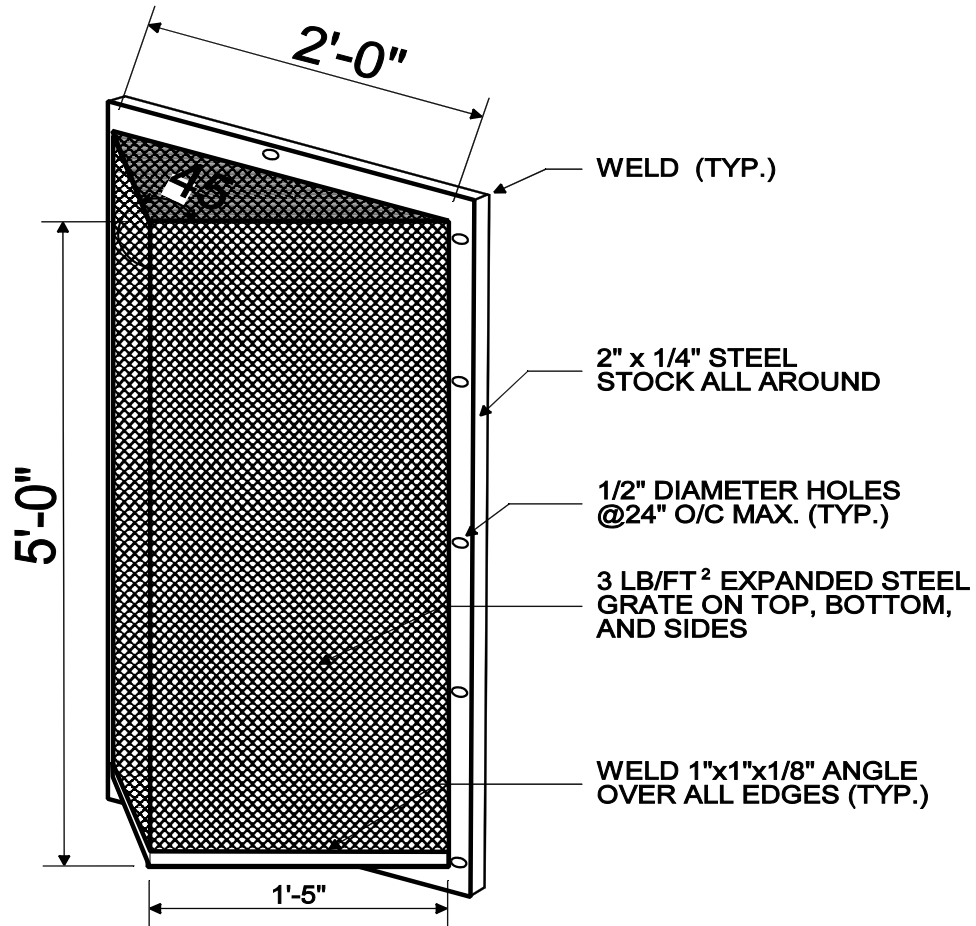

NOTES FOR TRASH RACK

1. TRASH RACK TO BE CENTERED OVER OPENING.
2. STEEL TO CONFORM TO ASTM A-36.
3. ALL SURFACES TO BE COATED WITH ZRC COLD GALVANIZING COMPOUND AFTER WELDING.

Figure K.2 Expanded Trash Rack Protection for Low Flow Orifice

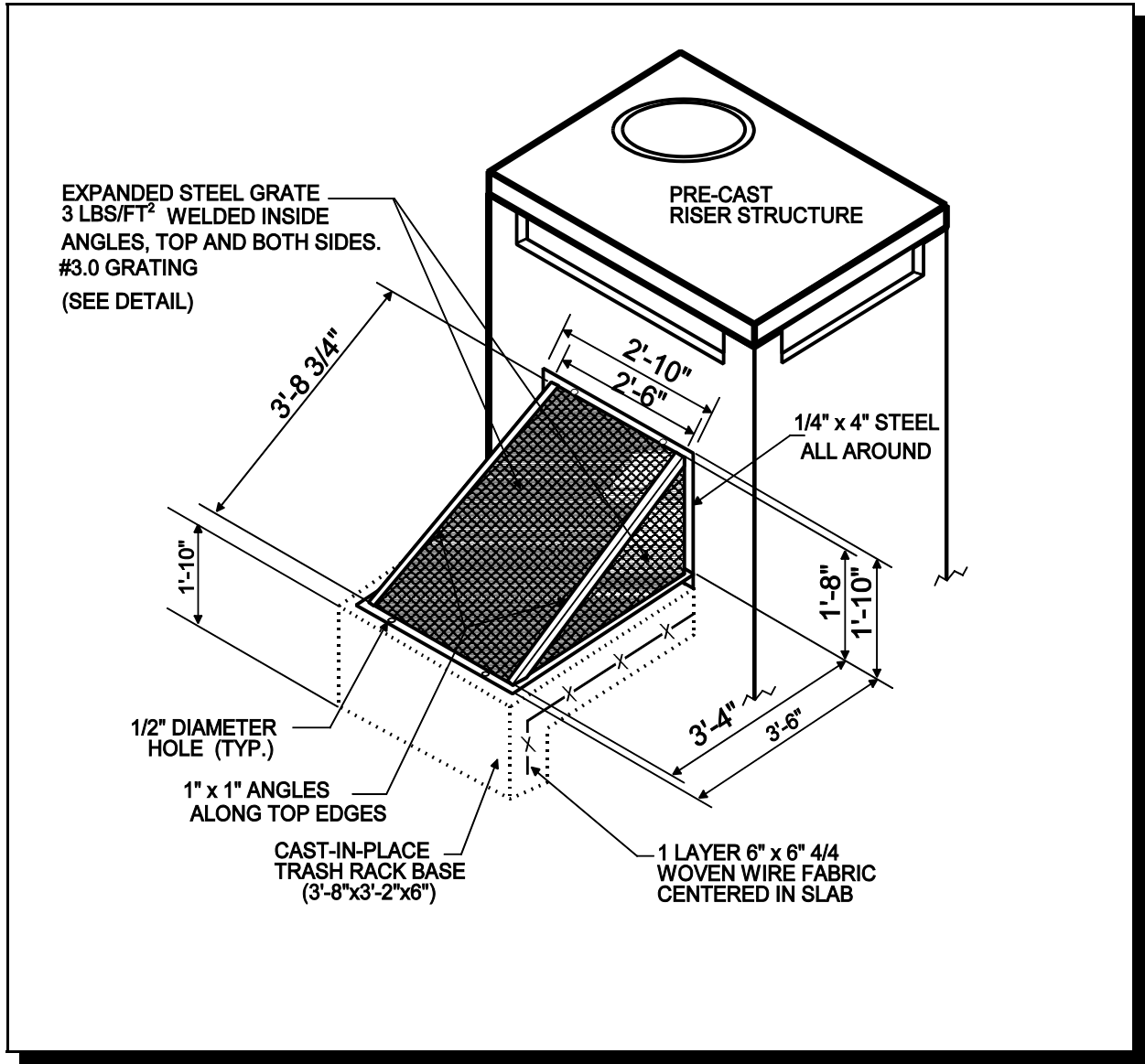

Figure K.3 Internal Control for Orifice Protection

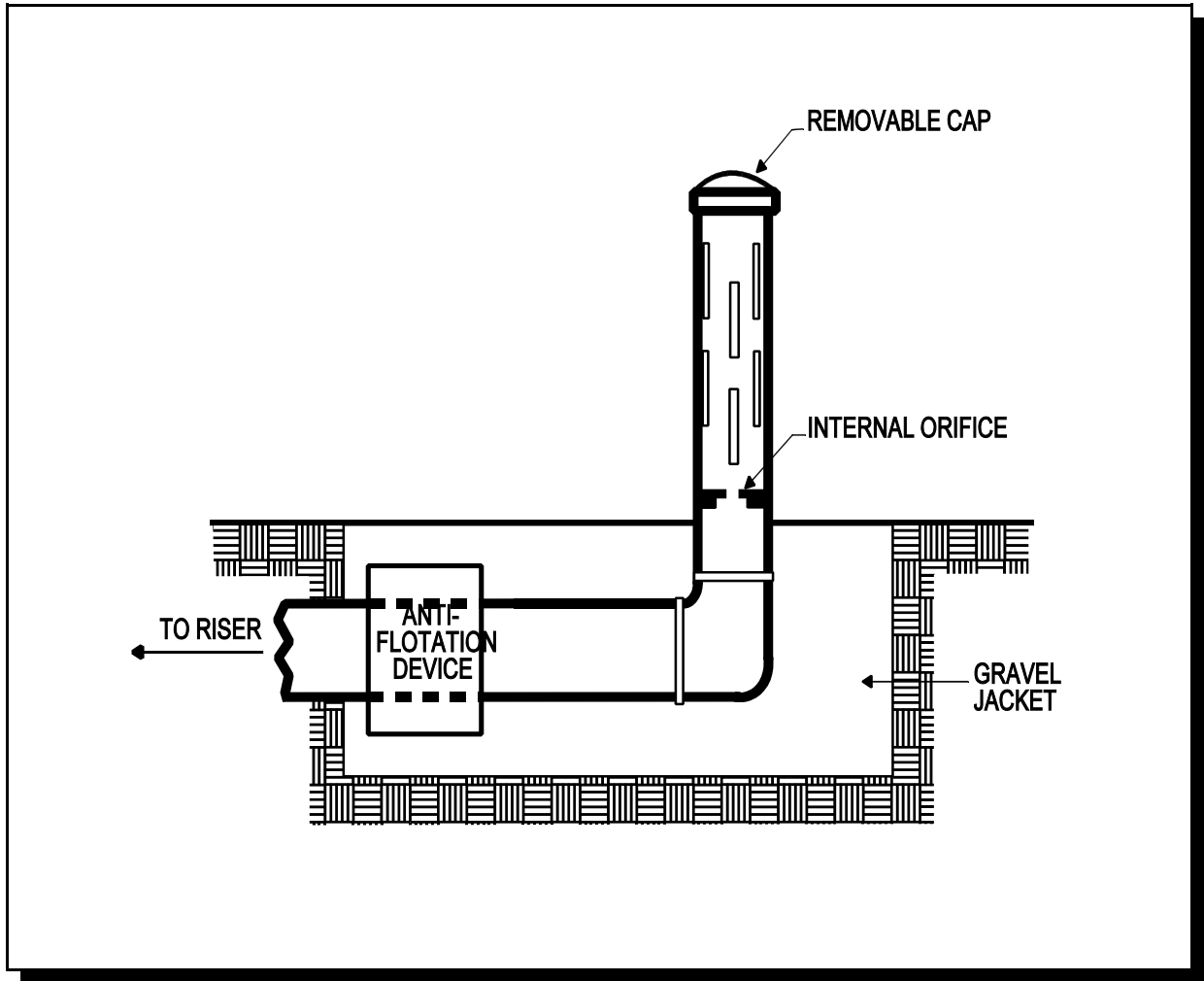
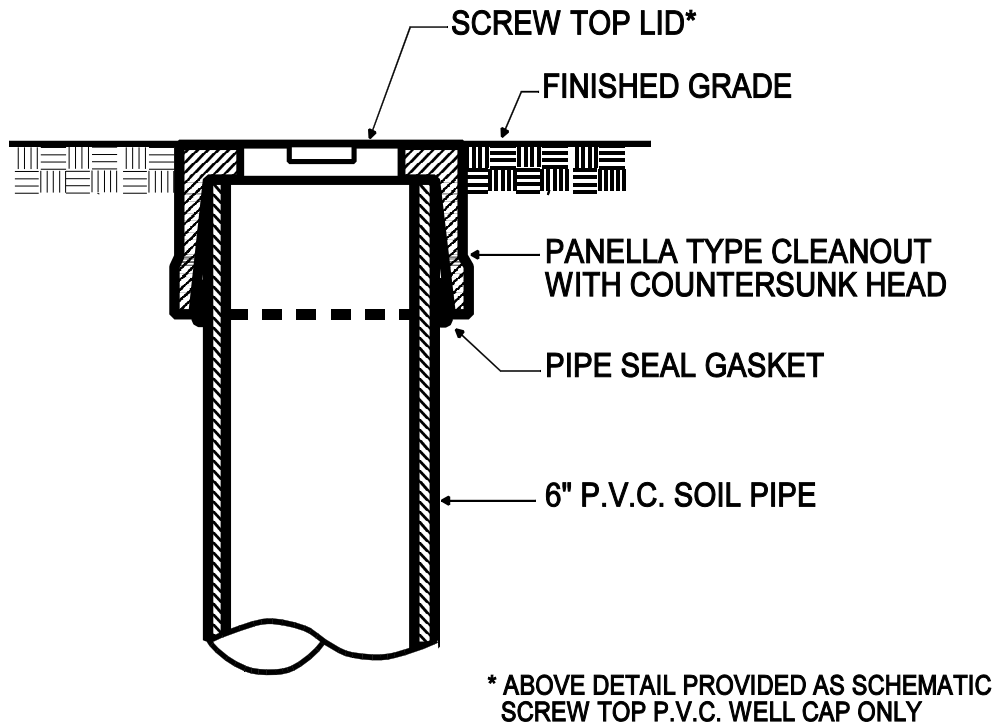

Figure K.4 Observation Well for Infiltration Practices



EACH OBSERVATION WELL / CLEANOUT SHALL INCLUDE THE FOLLOWING:

1. FOR AN UNDERGROUND FLUSH MOUNTED OBSERVATION WELL / CLEANOUT, PROVIDE A TUBE MADE OF NON-CORROSIVE MATERIAL, SCHEDULE 40 OR EQUAL, AT LEAST THREE FEET LONG WITH AN INSIDE DIAMETER OF AT LEAST 6 INCHES.
2. THE TUBE SHALL HAVE A FACTORY ATTACHED CAST IRON OR HIGH IMPACT PLASTIC COLLAR WITH RIBS TO PREVENT ROTATION WHEN REMOVING SCREW TOP LID. THE SCREW TOP LID SHALL BE CAST IRON OR HIGH IMPACT PLASTIC THAT WILL WITHSTAND ULTRA-VIOLET RAYS.

Figure K.5 On-Line Versus Off-Line Schematic

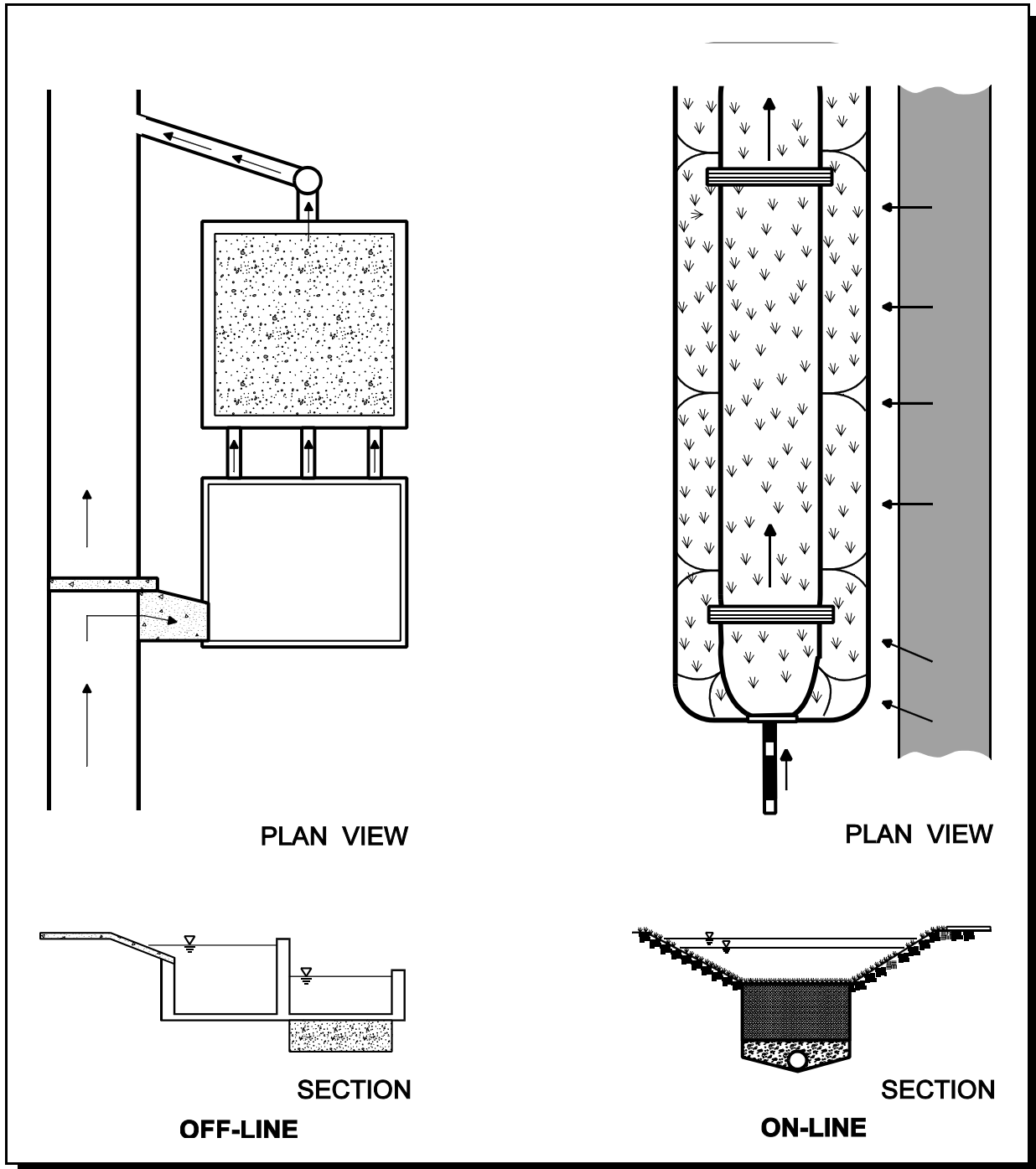

Figure K. 6 Isolation Diversion Structure

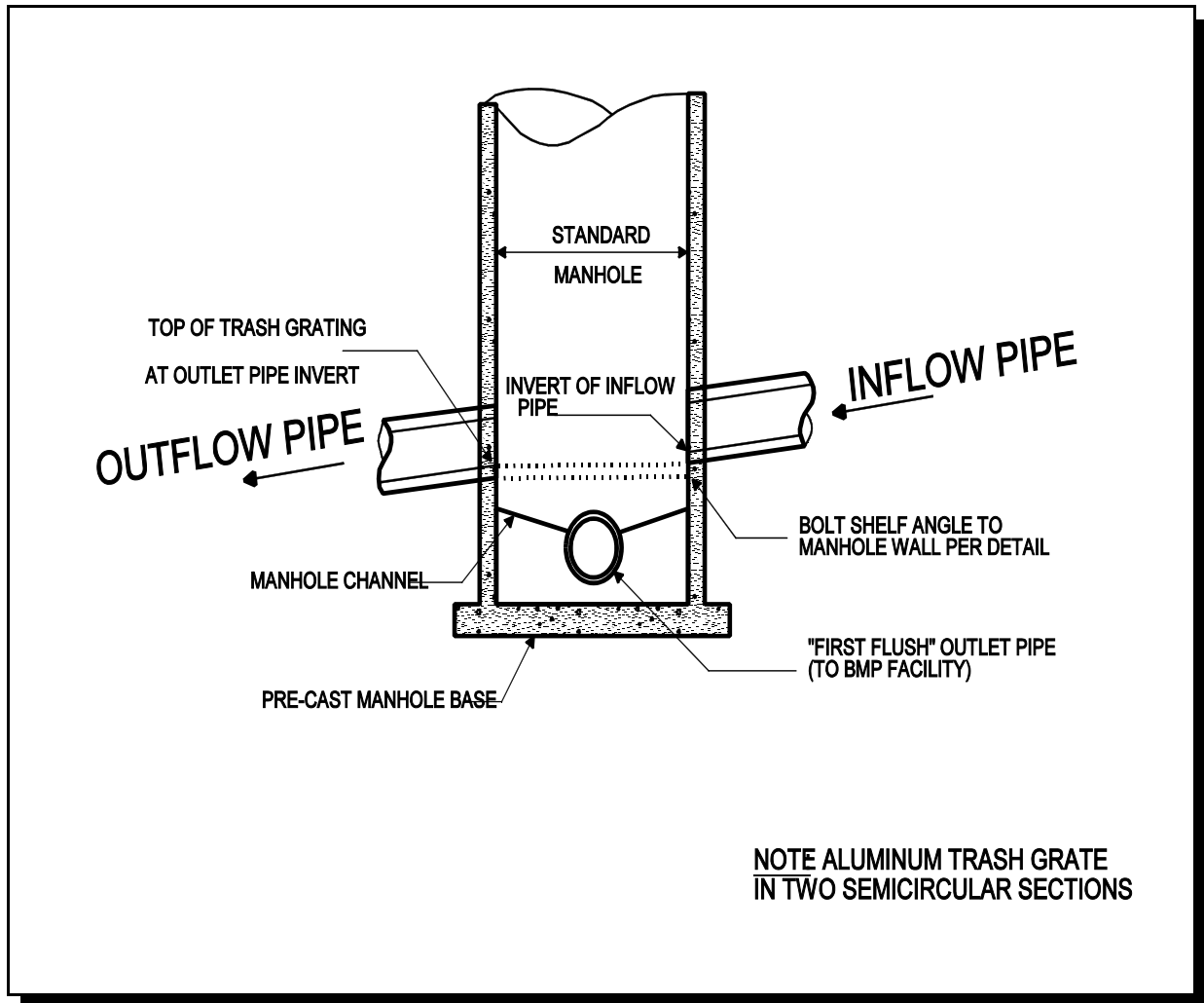

Figure K.7 Half Round CMP Hood

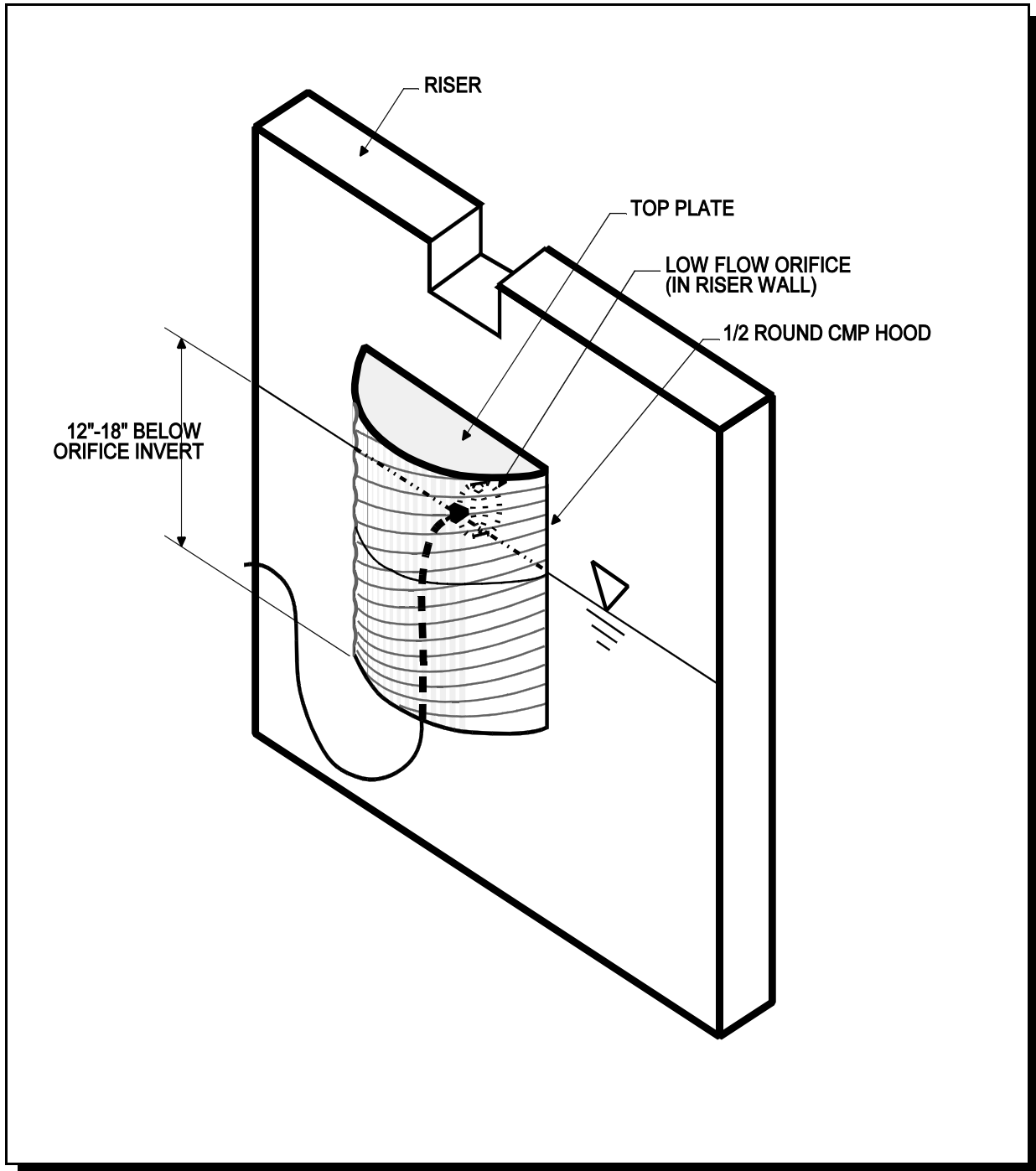

Figure K.8 Half Round CMP Weir

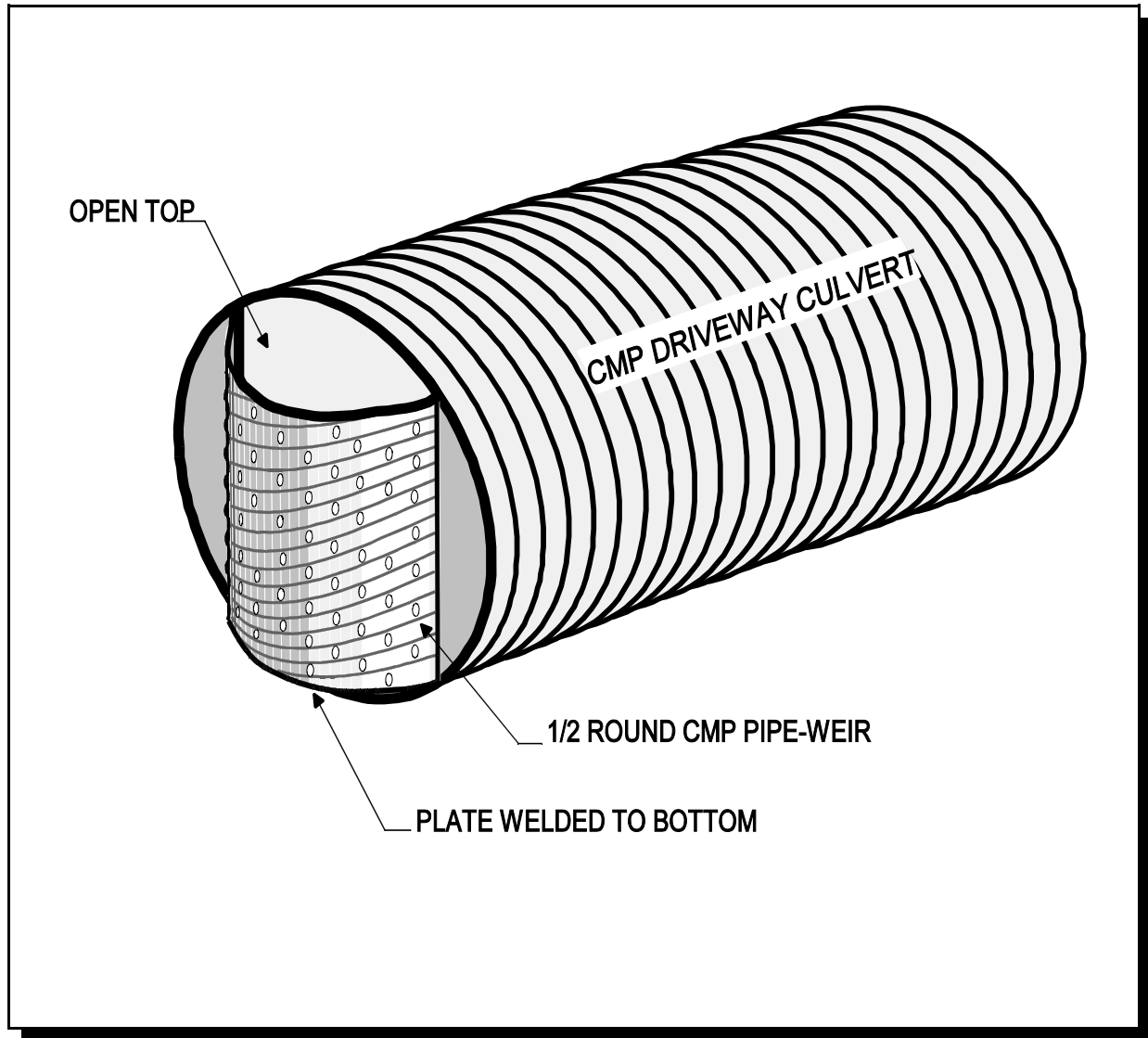

Figure K.9 Concrete Level Spreader

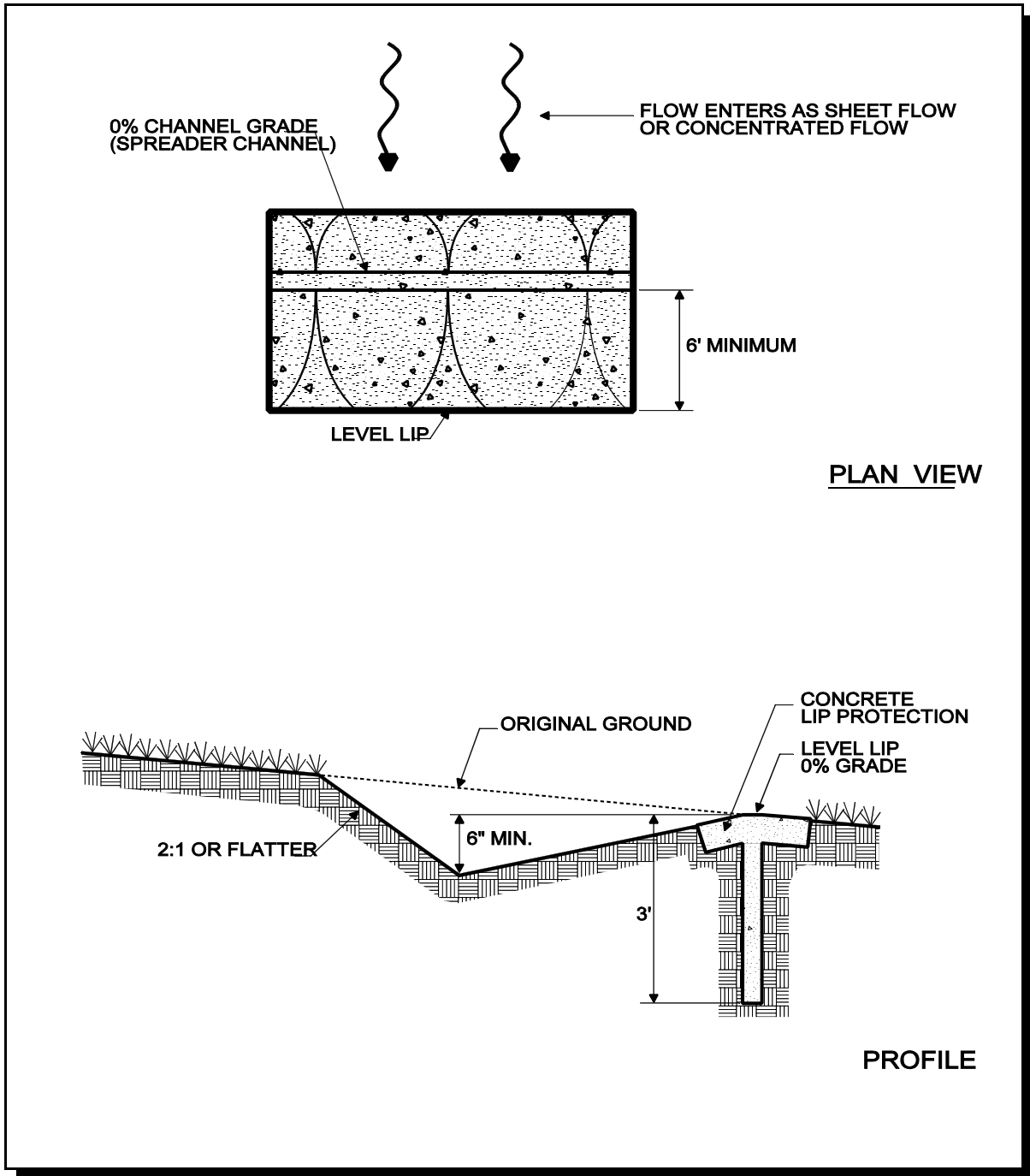

Figure K.10 Baffle Weir for Cold Climates

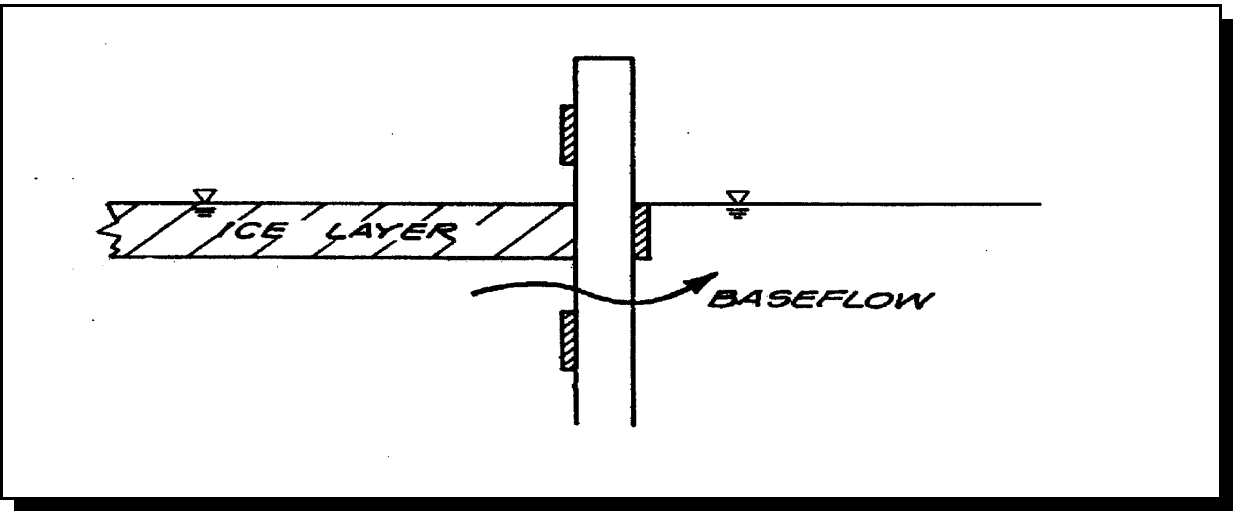

Figure K.11 Hooded Outlet with Hood Below Ice Layer

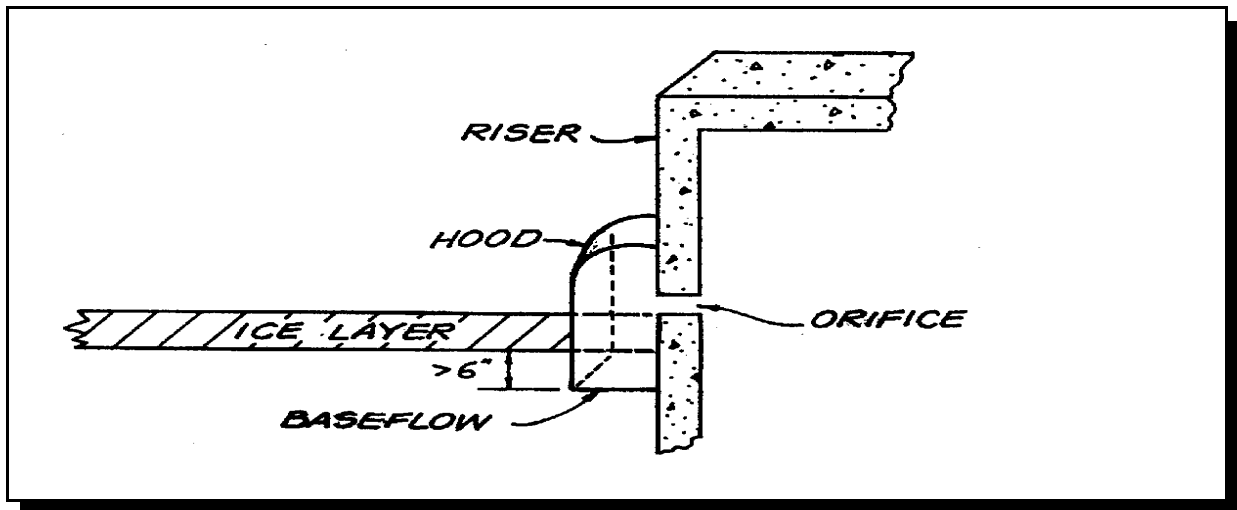
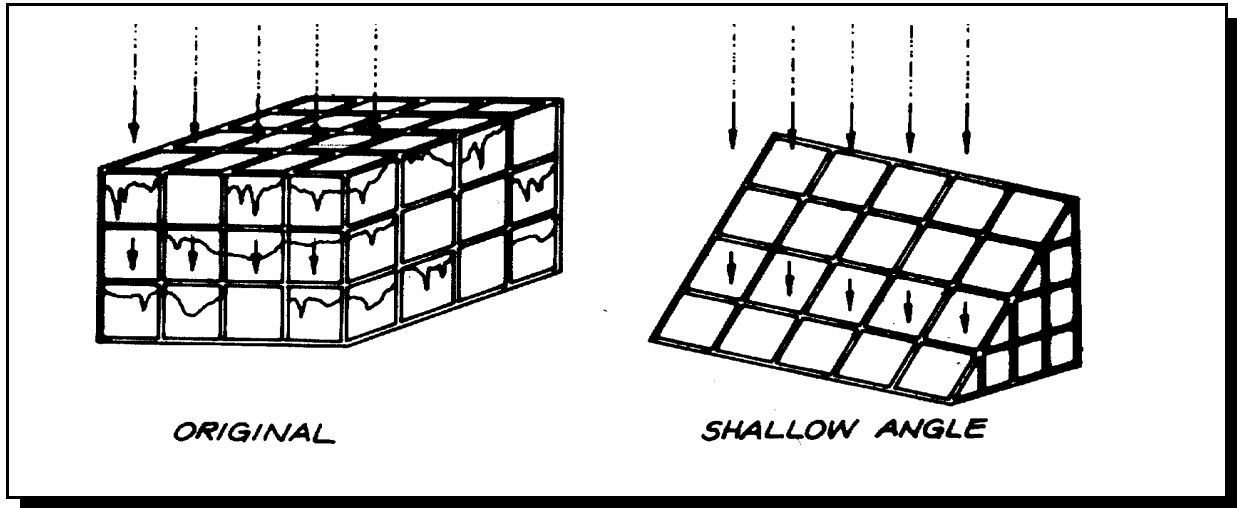

Figure K.12 Shallow Angle Trash Rack to Prevent Icing



This page is left intentionally blank

Appendix L

This page is left intentionally blank

Velocity

Maximum permissible velocities of flow in vegetated channels absent of permanent turf reinforcement matting shall not exceed the values shown in the following table:

Table L.1 Permissible Velocities for Channels Lined with Vegetation

Channel Slope	Lining	Permissible Velocity ¹ (ft/sec)
0-5%	Reed canarygrass Tall fescue Kentucky bluegrass	5
	Grass-legume mixture	4
	Red fescue Redtop Serices lespedeza Annual lespedeza Small grains	2.5
5-10%	Reed canarygrass Tall fescue Kentucky bluegrass	4
	Grass-legume mixture	3
Greater than 10%	Reed canarygrass Tall fescue Kentucky bluegrass	3

Source: Soil and Water Conservation Engineering, Schwab, *et al.*

For vegetated earth channels having permanent turf reinforcement matting, the permissible flow velocity shall not exceed 8 ft/sec. Turf reinforcement matting shall be a machine produced mat of nondegradable fibers or elements having a uniform thickness and distribution of weave throughout. Matting shall be installed per manufacturer’s recommendations with appropriate fasteners as required. Examples of acceptable products include but are not limited to:

- North American Green “C350” or “P300”
- Greenstreak “PEC-MAT”
- Tensar “Erosion Mat”

¹ For highly erodible soils, permissible velocities should be decreased 25%. An erodibility factor (K) greater than 0.35 would indicate a highly erodible soil. Erodiability factors (K-factors) can be obtained from local NRCS offices.

Manning's n value

The roughness coefficient, n , varies with the type of vegetative cover and flow depth. At very shallow depths, where the vegetation height is equal to or greater than the flow depth, the n value should be approximately 0.15. This value is appropriate for flow depths up to 4 inches typically. For higher flow rates and flow depths, the n value decreases to a minimum of 0.03 for grass channels at a depth of approximately 12 inches. The n value must be adjusted for varying flow depths between 4" and 12" (see Figure L.1).

Figure L.1 Manning's n Value with Varying Flow Depth (Source: Claytor and Schueler, 1986)

