



**New York State
DEPARTMENT OF ENVIRONMENTAL CONSERVATION**

Division of Water

New York State Standards and Specifications for Erosion and Sediment Control

August 2005



**New York State
Department of Environmental Conservation**

George E. Pataki, Governor

Page Intentionally Left Blank

NEW YORK STATE STANDARDS AND SPECIFICATIONS FOR EROSION AND SEDIMENT CONTROL

Prepared By:
NYS Soil and Water Conservation Committee
10B Airline Drive
Albany, NY 12235

For:
New York State Department of Environmental Conservation
625 Broadway
Albany, NY 12233

Contributing Agencies:

Center for Integrated Waste Management, Cornell University
New York State Conservation District Employees Association
New York State Department of Environmental Conservation
New York City Department of Environmental Protection
New York State Department of State
New York State Department of Transportation
New York State Soil & Water Conservation Committee
United States Department of Agriculture Natural Resources Conservation Service—formerly the Soil Conservation Service

General Disclaimer

The mention of trade names, products, proprietary processes, or companies does not constitute an endorsement by the New York State Department of Environmental Conservation. References are used for the purposes of information sources and alternative concepts. This manual is intended for periodic update and thus, sections may be changed or added as criteria for erosion and sediment control evolve.

Printed By:



Empire State Chapter
Soil and Water Conservation Society

For:



New York State
Department Of Environmental
Conservation

ACKNOWLEDGEMENTS

The New York Standard and Specifications for Erosion and Sediment Control have been prepared under a joint effort between the New York State Department of Environmental Conservation, the New York State Soil and Water Conservation Committee, the Cortland County Soil and Water Conservation District, and the Monroe County Soil and Water Conservation District. Several key individuals in these organizations and consultants comprised the project team and were responsible for the completion of this document.

- Daina Beckstrand, CPESC, Conservation Technician, Monroe County Soil and Water Conservation District, coordinated the compiling of these standards into a cohesive document, provided the computer support for the input of the standards, charts, and graphs, and provided technical review throughout the process.
- Paula Smith, CPESC, CPSWQ, Executive Director, Monroe County Soil and Water Conservation District, completed the small residential sites and model ordinance sections, coordinated the photographs, and provided technical review throughout the process.
- Karen Ervay, Office Manager, Monroe County Soil and Water Conservation District, incorporated the peer and public review comments and compiled the final document for publication.
- Fred Gaffney, Agronomist, prepared the vegetative and soil loss sections of the document and provided technical review throughout the process.
- John Dickerson, Plant Materials Specialist, USDA-NRCS, assisted in the preparation and review of the biotechnical measures section.
- David Walowsky, CPESC, Civil Engineering Technician, USDA-NRCS, compiled and prepared the CADD drawings and charts for the standard details.
- Matt Bakker, Technician, Monroe County Soil and Water Conservation District, incorporated the peer and public review comments and compiled the final document for publication.
- Shohreh Karimipour, P.E., CPESC, Environmental Engineer, NYS DEC, coordinated the DEC, public and peer review process, prepared responsiveness summary, and prepared electronic production of the document.
- Donald W. Lake Jr., CPESC, CPSWQ, Engineering Specialist, NYS SWCC, coordinated the overall project, prepared technical standards, and provided technical review throughout the process.

The project team would also like to recognize and thank Phil DeGaetano and Robin Warrender, whose team approach and environmental visions created the opportunity for the development of these standards.

In addition, the following individuals provided comments during the public/peer review process:

Andrew B. Fetherston, P.E.; Andrew Labruzzo; Bernard E. Schmelz, AICP; Robert Dunn; Chad Kehoe; Daniel D. O'Brien, P.E.; David H. Johnson; Dave Gasper; Donald Kuhn; Edward Wiles; Edwin Polese, P.E.; Ellen Z. Harrison; Glen Ballinger; John R. Dergosits, P.E.; John Lacy; Jim Harrington; Matthew Brower; Laura Snell; Mary E. Ivey; Peter M. Melewski, P.E.; Samuel Gleason; Steven VanHaren, P.E.; Steven Potter; Walter E. Grajko, P.E.; Angus Eaton; Walter Artos; Joseph Sorace; James Huston; James Harrington; Gary Feinland; John Stawski.

PREFACE

The parent document, "Guidelines for Erosion and Sediment Control in Urban Areas of New York State," was originally published by the USDA Soil Conservation Service in 1972 to provide information on minimizing erosion and sediment problems on land undergoing development. These guidelines were used by soil and water conservation districts, planning boards, property owners, land developers, contractors, and consultants.

Based upon the experience gained in the use of this document, a committee was formed in 1978 to update this guide. This committee contained specialists and representatives from government, academia and the private sector.

This committee completed their draft document, "Sediment and Erosion Control for Developing Areas," in May 1980. Before this document could be finalized, technological advances and increased demand for natural resource planning due to increased urban pressure on rural areas, caused an additional need for revision and expansion of the technical chapters.

In March 1985, work resumed on the guide to expand the standards and specifications to include temporary and permanent structural measures for erosion and water control, update the discipline vocabulary, incorporate the most recent methods and procedures available, and provide local planners and legislators examples of public administration. That guide was again revised in mid-1991 to incorporate general updates, a chapter on calculating runoff, a chapter on bio-engineering, the addition of temporary and permanent practices and a site specific example demonstrating the planning and design process.

A general State Pollution Discharge Elimination System (SPDES) permit for construction activities was approved for New York State by the Environmental Protection Agency on August 1, 1993. That permit was necessary for any construction site that disturbed five or more acres.

It required a stormwater pollution prevention plan to be prepared for the specific site. The plan must address erosion and sediment control and stormwater management.

The SPDES permit was revised in January, 2003 to incorporate the United States Environmental Protection Agency—National Pollutant Discharge Elimination System (NPDES) Phase 2 stormwater requirements. This requires construction sites disturbing one or more acres to have an erosion and sediment control plan. This document has been re-written to incorporate the most recent developments in the discipline.

The purpose of this document is to protect water quality due to construction activity and reduce sediment damage and associated maintenance costs of road ditches, storm sewers, streams, lakes, and flood control structures. It is distributed by the Empire State Chapter of the Soil and Water Conservation Society and also available on the New York State Department of Environmental Conservation stormwater web site.

This manual should be used by site developers in preparing their erosion and sediment control plans, and by local municipalities in preparing and implementing their soil erosion and sediment control programs, reviewing proposed site development plans, establishing or encouraging uniformity through standards in applying erosion control techniques, and helping developers, private engineers, and planners make maximum use of potential development sites by proper management of their natural resources.

This manual of standards and specifications was prepared for and under the direction of, the New York State Department of Environmental Conservation, Division of Water. It is issued by the New York State Department of Environmental Conservation as minimum standards for erosion and sediment control plans prepared for state permits.



Sandra Allen
Director, Division of Water, NYS DEC



Ronald T. Kaplewicz
Director, NYS SWCC

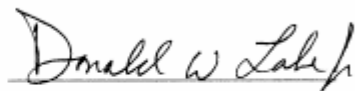

Donald W. Lake Jr., PE
Engineering Specialist, NYS SWCC

Page Intentionally Left Blank

CONTENTS

SECTION 1	INTRODUCTION
SECTION 2	EROSION CONTROL PLANNING AND SITE MANAGEMENT
SECTION 3	VEGETATIVE MEASURES FOR EROSION AND SEDIMENT CONTROL
SECTION 4	BIOTECHNICAL MEASURES FOR EROSION AND SEDIMENT CONTROL
SECTION 5	STRUCTURAL MEASURES FOR EROSION AND SEDIMENT CONTROL
SECTION 5A	STRUCTURAL MEASURES – TEMPORARY
SECTION 5B	STRUCTURAL MEASURES – PERMANENT

APPENDICES

APPENDIX A	REVISED UNIVERSAL SOIL LOSS EQUATION (RUSLE)
APPENDIX B	PERFORMANCE EVALUATION FOR TEMPORARY EROSION AND SEDIMENT CONTROL PRACTICES
APPENDIX C	COST ANALYSIS OF EROSION AND SEDIMENT CONTROL PRACTICES
APPENDIX D	FERTILIZER LABELS AND PURE LIVE SEED
APPENDIX E	EROSION AND SEDIMENT CONTROL PLAN FOR SMALL HOMESITE CONSTRUCTION
APPENDIX F	EXAMPLE EROSION AND SEDIMENT CONTROL PLAN
APPENDIX G	SAMPLE CHECKLIST FOR REVIEWING EROSION & SEDIMENT CONTROL PLANS
APPENDIX H	CONSTRUCTION SITE INSPECTION & MAINTENANCE SITE LOG BOOK

GLOSSARY

DIRECTORIES

NATURAL RESOURCES CONSERVATION SERVICE FIELD OFFICES IN NY

COUNTY SOIL & WATER CONSERVATION DISTRICT OFFICES IN NY

NEW YORK DEPARTMENT OF ENVIRONMENTAL CONSERVATION REGIONAL OFFICES, DIVISION OF WATER

NEW YORK CITY DEPARTMENT OF ENVIRONMENTAL PROTECTION

U.S. ARMY CORPS OF ENGINEERS

DELAWARE RIVER BASIN COMMISSION

SUSQUEHANNA RIVER BASIN COMMISSION

REGIONAL PLANNING COUNCILS

COUNTY CORNELL COOPERATIVE EXTENSION OFFICES IN NY

Page Intentionally Left Blank

SECTION 1—INTRODUCTION

CONTENTS

	<u>Page</u>
Purpose.....	1.1
Scope and Authority.....	1.1
Erosion and Sediment Hazards Associated with Development.....	1.1
How to Use This Manual.....	1.1
Basic Principles of Erosion and Sediment Control.....	1.3

Section prepared by:

Donald W. Lake Jr., P.E., CPESC, CPSWQ
Engineering Specialist
New York State Soil & Water Conservation Committee

INTRODUCTION

Purpose

The purpose of this manual is to provide minimum standards and specifications for meeting criteria set forth by the New York State Department of Environmental Conservation (NYS DEC) for stormwater discharges associated with construction activity. The standards and specifications provide criteria on minimizing erosion and sediment impacts from construction activity involving soil disturbance. They show how to use soil, water, plants, and products to protect the quality of our environment. These standards and specifications were developed in cooperation with the USDA Natural Resources Conservation Service, New York State Soil and Water Conservation Committee (NYSSWCC), NYS DEC and other state and local agencies for use by planners, design engineers, developers, contractors, landscape architects, property owners, and resource managers. Proper use of these standards will protect the waters of the state from sediment loads during runoff events.

Scope and Authority

The standards and specifications apply to lands within New York State where housing, industrial, institutional, recreational, or highway construction, and other land disturbances are occurring or imminent. They are statewide in scope and, in some cases, are somewhat generalized due to variations in climate, topography, geology, soils, and plant requirements. Feasible ways to minimize erosion and sedimentation are varied and complex. Following these standards and specifications is presumed to be in compliance with the SPDES general permit for construction activities. Alternative methods may be explored on a case specific basis and shall be discussed with NYS DEC regional staff.

The Environmental Protection Agency delegated stormwater responsibility for the National Pollutant Discharge Elimination System (NPDES) Permit to New York on October 1, 1992. New York State issued its first General Permit for stormwater discharges from construction activities on August 1, 1993. This was issued pursuant to Article 17, Titles 7, 8 and Article 70 of Environmental Conservation Law. At a minimum, an erosion and sediment control plan must be prepared for any construction activity that disturbs one or more acres.

Erosion and Sediment Hazards Associated with Development

Many people may be adversely affected by development on relatively small areas of land. Uncontrolled erosion and sediment from these areas may cause considerable economic damage to individuals and society in general.

Stream pollution and damages to public facilities and private homes are examples. Hazards associated with land disturbance include:

1. A large increase of soil exposed to erosion from wind and water;
2. Increased water runoff, soil movement, sediment accumulation and peak flows caused by:
 - a. Removal of plant cover;
 - b. A decrease in the area of soil which can absorb water because of construction of streets, buildings, sidewalks, and parking lots;
 - c. Changes in drainage areas caused by grading operations, diversions, and streets;
 - d. Changes in volume and duration of water concentrations caused by altering steepness, distance, and surface roughness;
 - e. Soil compaction by heavy equipment, which can reduce the water intake of soils as much as 90 percent of the original rate; and,
 - f. Prolonged exposure of unprotected sites and disturbed areas to poor weather conditions.
3. Altering the groundwater regime that may adversely affect drainage systems, slope stability, survival of existing vegetation and establishment of new plants;
4. Exposing subsurface materials that are too rocky, too acid, or otherwise unfavorable for establishing plants;
5. Obstructing stream flow with new buildings, dikes, and land fills;
6. Improper timing and sequencing of construction and development activities; and,
7. Abandonment of sites before completion of construction.

How to Use This Manual

The standards and specifications listed in this manual have been developed over time to reduce the impact of soil loss from construction sites to receiving water bodies and adjacent properties. This manual provides designers with details on how to plan a site for erosion and sediment control and how to select, size, and design specific practices to meet these resource protection objectives. The appendices at the end of this manual contain additional information as guidance for site plan design and review, construction implementation, and site inspection. Review and inspection checklists are provided to aid planners and designers in meeting the standards requirements.

Section 2. Erosion Control Planning and Site Management

This section discusses the objectives of the erosion and sediment control plan. Site and off-site resources are identified and incorporated into a six step planning process. In addition, special considerations for project development and their relationship to the erosion and sediment control plan are discussed.

Section 3. Vegetative Measures for Erosion and Sediment Control

This section provides a number of specific vegetative standards to meet a variety of project needs. These measures are generally looked at first for their low cost and high performance capability in reducing erosion.

Section 4. Bio-Technical Measures for Erosion and Sediment Control

This section describes bio-technical standards that use plant materials to stabilize slopes, road banks, and streambanks. These standards provide environmentally friendly stabilization measures that may be implemented either alone, or in combination with structural components.

Section 5. Structural Measures for Erosion and Sediment Control

This section is subdivided into temporary and permanent practices. The temporary practices are generally designed based on the site's drainage area. The permanent practices have detailed design procedures included in the text of the standard. Standards and specifications are included for controlling runoff and sediment.

Appendices

Appendix A. The Impact of Soil Loss

Soil types at construction sites play a predominant role in how the site should be constructed to control erosion. Knowledge of soil properties, particularly when soils are highly erosive, is essential. This appendix discusses soil properties and provides a method to compute potential soil loss and reduction control depending on slope, area, and protective cover.

Appendix B. Performance Evaluation for Temporary Erosion and Sediment Control Practices

This appendix offers a method of evaluating the performance of a practice and is applicable to most of the temporary practices found in this manual. This will allow a designer to evaluate an existing condition, or to select a specific level of protection higher than that which may be provided by the standard details.

Appendix C. Cost Analysis of Erosion and Sediment Control Practices

This appendix provides historical bid information for most of the practices contained in the manual. Sources included the NYS Department of Transportation, Monroe County SWCD, and other county soil and water conservation districts. This information will allow a designer to prepare cost estimates for specific erosion and sediment control plans.

Appendix D. Fertilizer Labels and Pure Live Seed

This appendix contains a review on how to read fertilizer labels and compute pure live seed with an example for site application.

Appendix E. Erosion Control for Small Residential Sites

Within New York State SPDES requirements, many small residential sites have to file for permit coverage. All of these sites will need erosion and sediment control plans. This appendix presents plans for scenarios that can be used by the local authorities and site owners. Attaching the appropriate plan to the building permit assists the owner with compliance with the provisions of the permit.

Appendix F. Soil Erosion and Sediment Control Plan—Site Example

This appendix illustrates the development of the erosion and sediment control plan from the proposed grading changes to final stabilization. Details of the construction sequence and practices utilized are described.

Appendix G. Sample Checklist for Reviewing Erosion and Sediment Control Plans

This appendix includes a comprehensive checklist for use by all site plan reviewers (including planning board members, conservation board members, conservation district personnel, engineers, consultants, approval authorities, and others) when reviewing erosion and sediment control plans for completeness and proper management.

Appendix H. Construction Site Inspection & Maintenance Site Log Book

A proper site inspection, whether conducted by local authorities or project staff, is necessary to assess the site conditions and the practices implemented. This appendix includes a detailed checklist to assist inspectors in conducting a thorough evaluation of the site when judging the effectiveness of the erosion and sediment control measures.

BASIC PRINCIPLES OF EROSION AND SEDIMENT CONTROL

The Erosion and Sedimentation Processes

The standards, specifications, and planning guidelines presented in this document are intended to be utilized when development activities change the natural topography and vegetative cover of an area. Erosion and sediment control plans must be designed and constructed to minimize erosion and sediment problems associated with soil disturbance. To understand how erosion and sediment rates are increased requires an understanding of the processes themselves.

Soil erosion is the removal of soil by water, wind, ice, or gravity. This document deals primarily with the types of soil erosion caused by rainfall and surface runoff. Raindrops strike the soil surface at a velocity of approximately 25-30 feet per second and can cause splash erosion. Raindrop erosion causes particles of soil to be detached from the soil mass and splash into the air. After the soil particles are dislodged, they can be transported by surface runoff, which results when the soil becomes too saturated to absorb falling rain or when the rain falls at an intensity greater than the rate at which the water can enter the soil. Scouring of the exposed soil surface by runoff can cause further erosion. Runoff can become concentrated into rivulets or well-defined channels up to several inches deep. This advanced stage is called rill erosion. If rills and grooves remain unrepaired, they may develop into gullies when more concentrated runoff flows downslope.

Sediment deposition occurs when the rate of surface flow is insufficient for the transport of soil particles. The heavier particles, such as sand and gravel, transport less readily than the lighter silt and clay particles. Previously deposited sediment may be suspended by runoff from another storm and transported farther downslope. In this way, sediment is carried intermittently downstream from its upland point of origin.

Factors That Influence Erosion

The erosion potential of a site is determined by five factors; soil erodibility, vegetative cover, topography, climate, and season. Although the factors are interrelated as determinants of erosion potential, they are discussed separately for easy understanding.

1. **Soil Erodibility** – The vulnerability of a soil to erosion is known as erodibility. The soil structure, texture, and percentage of organic matter influence its erodibility. The most erodible soils generally contain high proportions of silt and very fine sand. The presence of clay or organic matter tends to decrease soil erodibility. Clays are sticky and tend to bind soil particles together. Organic matter helps to maintain stable soil structure (aggregates).

2. **Vegetative Cover** – Vegetation protects soil from the erosive forces of raindrop impact and runoff scour in several ways. Vegetation (top growth) shields the soil surface from raindrop impact while the root mass holds soil particles in place. Grass buffer strips can be used to filter sediment from the surface runoff. Grasses also slow the velocity of runoff, and help maintain the infiltration capacity of a soil. The establishment and maintenance of vegetation are the most important factors in minimizing erosion during development.

3. **Topography** – Slope length and steepness greatly influence both the volume and velocity of surface runoff. Long slopes deliver more runoff to the base of slopes and steep slopes increase runoff velocity. Both conditions enhance the potential for erosion to occur.

4. **Climate** – Climate also affects erosion potential in an area. Rainfall characteristics such as frequency, intensity, and duration directly influence the amount of runoff that is generated. As the frequency of rainfall increases, water has less chance to drain through the soil between storms. The soil will remain saturated for longer periods of time and stormwater runoff volume may be potentially greater. Therefore, erosion risks are high where rainfall is frequent, intense, or lengthy.

5. **Season** – Seasonal variation in temperature and rainfall defines periods of high erosion potential during the year. High erosion potential may exist in the spring when the surface soil first thaws and the ground underneath remains frozen. A low intensity rainfall may cause substantial erosion because the frozen subsoil prevents water infiltration. In addition, the erosion potential increases during the summer months due to more frequent, high intensity rainfall.

Page Intentionally Left Blank

SECTION 2
EROSION CONTROL PLANNING AND SITE MANAGEMENT

CONTENTS

	<u>Page</u>
List of Tables	
List of Figures	
Natural Resource and Watershed Planning.....	2.1
Site Development Plans.....	2.1
Predicting Soil Losses.....	2.4
Estimating Sediment Yield.....	2.4
Professional Certification.....	2.4
Erosion and Sediment Control Ordinances and Subdivision Regulation.....	2.4
Steps in Selection of Control Measures.....	2.5
Planning Flow Charts.....	2.6
Erosion and Sediment Control Practices Matrix.....	2.9
References	

Section prepared by:

Donald W. Lake Jr., P.E., CPESC, CPSWQ
Engineering Specialist
New York State Soil & Water Conservation Committee

List of Tables

<u>Table</u>	<u>Title</u>	<u>Page</u>
2.1	Erosion and Sediment Control Practices Matrix.....	2.9
2.2	Erosion Risk.....	2.12

List of Figures

<u>Figure</u>	<u>Title</u>	<u>Page</u>
2.1	Planning Flow Chart – Runoff Control.....	2.6
2.2	Planning Flow Chart – Soil Stabilization.....	2.7
2.3	Planning Flow Chart – Sediment Control.....	2.8

EROSION CONTROL PLANNING AND SITE MANAGEMENT

Natural Resource & Watershed Planning

The most effective solutions to erosion and sediment problems begin with natural resource and watershed planning. This type of planning can guide and control development growth, preventing wasteful and haphazard development. The natural resource planning process integrates ecological (natural resource), economic, and social considerations to meet private and public needs. This approach, which emphasizes identifying desired future conditions, improves natural resource management, minimizes conflict, and addresses problems and opportunities.

Watershed planning is another useful tool for building a community's land use plans because watersheds are defined by natural hydrology, representing the most logical basis for managing water resources. The resource becomes the focal point, and planners are able to gain a more complete understanding of overall conditions in an area and the stressors which affect those conditions.

Regional, county and local planning agencies, Soil and Water Conservation Districts (SWCD), and the Natural Resource Conservation Service (NRCS) have technical expertise, resource data and information that can assist decision making by local authorities. These decisions should consider reserving quality agricultural areas for cropland; maintaining the economic viability of agriculture; protecting historical, scenic, and natural beauty areas; protecting wetlands and stream corridors; providing for open spaces and parks; developing attractive residential, institutional and industrial areas; and maintaining floodplains for flood storage, groundwater recharge, water supply source protection, critical habitat preservation, recreation buffer zones, and conservation education uses. Environmental quality is enhanced when open spaces, parks, recreational areas, ponds, wildlife habitat and other areas of public use become integral parts of the plan. These areas should be well delineated and protected from damage that may occur from nearby construction. Selections of such areas should be based upon soils, vegetation, water, topography, accessibility, wildlife, and aesthetic values.

Site Development Plans

As land is subdivided or proposals brought forward for land development, an assessment of suitability of the site for the proposed development needs to be made.

I. Technical Data Requirements

Features of the site including location, accessibility, present land use, delineation of areas protected by local,

state and federal regulations (e.g. wetlands and streams), size of proposed tract(s), topography, drainage pattern, geology, hydrology, soils, vegetation and climate need to be assembled. Such information is obtained from on-site examinations and existing technical reports, maps, records, and other documented material usually available from local sources.

The technical data provides the framework necessary to make informed decisions about a sites ultimate use and the types of erosion and sediment controls that will work. Soils information such as detailed soil maps and interpretation sheets may be available in local NRCS and SWCD offices and will specifically provide the following soils information:

- a. Descriptions, erodibility, limitations, and capabilities;
- b. Engineering properties of soils;
- c. Suitability of the soil as a resource material for topsoil, gravel, highway sand, dams and levees;
- d. Site suitability for buildings, roads, winter soil disturbance, foundations, septic tank disposal fields, sanitary land fills, vegetation, reservoirs, dams, artificial drainage, recreational areas and wildlife development.

II. Site Plan Design Steps

1. Plan the Development to Fit the Site

Assess the physical characteristics of the site to determine how it can be developed with the lowest risk of environmental damage. Minimize grading by utilizing the existing topography wherever possible. Delineate and avoid disturbing wetlands, stream corridors and, to the extent practicable, wood lots, steep slopes and other environmentally sensitive areas. **Minimize impacts by maintaining vegetative buffer strips between disturbed and adjacent areas.** Existing woody or state protected vegetation on a project site should be delineated, retained, and protected as required. Planning of streets and lots should relate to site conditions. Streets laid out at right angles to contours often have excessive grades that increase erosion hazards and sedimentation.

2. Determine Limits of Clearing and Grading

Decide exactly which areas must be disturbed in order to accommodate the proposed construction. Pay special attention to critical areas (e.g. steep slopes, highly erodible soils, surface water borders), which must be disturbed. Staged clearing and grading is necessary to keep areas of disturbance to less than 5 acres.

3. Divide the Site into Natural Drainage Areas

Determine how runoff will drain from the site. Natural drainage channels should not be altered or relocated without the proper approvals. Pursuant to Article 15 of the Environmental Conservation Law (ECL), a protected stream and the bed and banks thereof should not be altered or relocated without the approval of the Department of Environmental Conservation. Section 404 of the Clean Water Act also protects water resources and proposed disturbances may require approvals from The US Army Corps of Engineers.

Integrated surface and storm drainage systems are an essential part of any planned development. The plan should clearly specify: location and capacity of diversions and debris basins; paved or other types of lined chutes, outlets and waterways; drop inlets; open or closed drains; stream channel protection and bank erosion structures. Consider how erosion and sedimentation can be controlled in each small drainage area before looking at the entire site.

Diversion of surface water away from exposed soils provides the most economic and effective erosion control possible since it is more advantageous to control erosion at the source than to design controls to trap suspended sediment.

4. Design The Erosion and Sediment Control (ESC) Plan

Natural resources need to be identified in the planning process in order to design an appropriate ESC plan. The plan must have resource protection at its core and emphasize **EROSION CONTROL** (controlling runoff and stabilizing soil), first as its main component and sediment control, second as a management practice. The reduction of soil loss decreases the cost and maintenance of sediment control practices, reduces the risk of degrading natural resources and improves the overall appearance of the construction site.

An ESC plan shows the site's existing topography, and how and when it will be altered. It also shows the ESC measures that will be used to reduce sediment pollution and how and when they will be constructed and maintained. The coordination of ESC practices with construction activities is explained on the plan by a phasing and sequencing schedule.

In addition to regulatory control, an ESC plan should be prepared for all land development and construction activity when uncontrolled erosion and sedimentation will be a problem. As a minimum, this includes:

- a. sites on slopes that exceed 15% or sites in areas of severe erosion potential where such areas have been mapped;
- b. sites within 100 ft. of a wetland; and/or
- c. sites within 100 ft. of any watercourse.

The plan should be prepared and presented during the State Environmental Quality Review Act (SEQRA) process. The plan must be designed so that suspended, colloidal, and settleable solids are not discharged in amounts that cause substantial visible contrast to natural conditions, or cause deposition or impair the waters for their best (classified) uses (6 NYCRR, Part 703.2).

This means that stream reaches on-site and downstream of construction areas shall not have substantial visible contrast to natural conditions relative to color, taste, odor, turbidity, and sediment deposition from the reaches upstream of the construction area.

ESC practices are divided into vegetative and structural controls. While more details on these practices are contained in other sections of this handbook, general guidance on vegetative and structural controls is outlined below.

A. Vegetative Controls—The best way to protect the soil surface and limit erosion is to preserve the existing vegetative groundcover. Where land disturbance is necessary, temporary seeding or mulching must be used on areas which will be exposed for more than 14 days. Permanent stabilization should be performed as soon as possible after completion of grading. ESC plans must contain provisions for permanent stabilization of disturbed areas. Seed type, soil amendments, seedbed preparation, mulch, and mulch anchoring must be described on the plans. Selection of permanent vegetation will include the following considerations for each plant species:

- 1) establishment requirements;
- 2) adaptability to site conditions;
- 3) aesthetic and natural resource values;
- 4) maintenance requirements.

B. Structural Controls—Structural erosion control practices may be necessary when disturbed areas cannot be promptly stabilized with vegetation. Structural practices shall be constructed and maintained in accordance with the standards and specifications in this manual. Structural practices may be temporary or permanent. Temporary practices are removed after site stabilization is completed. Permanent practices, such as diversions, are an integral part of the site design and are left in place.

An ESC plan includes:

1. Existing and proposed contours shown at two foot intervals or less. Other scales or contour intervals may be favored for special types of land disturbance projects (i.e. plans are often drawn to scales of 1 in. = 200 ft. or 1 in. = 500 ft. with contour intervals of 5 to 20 feet). The following scales are recommended for use on ESC plans because they facilitate the plan review process: 1 in. = 20 ft., 1 in. = 30 ft., 1 in. = 40 ft., or 1 in. = 50 ft.
2. Details of temporary and permanent structural and vegetative measures that will be used to control erosion and sedimentation for each stage of the project from land clearing to the finished stage. Stabilizing land with plant materials or mulches shall be part of a planned development. Retention of existing natural vegetation in strategic areas is beneficial, desirable, and cost efficient.
3. The location of structural ESC measures with standard symbols to facilitate the understanding and review of plans. Symbols should be bold and easily discernible on the plans.
4. Dimensional details of proposed ESC facilities as well as calculations used in locating and sizing of sediment basins.
5. Notes regarding temporary ESC facilities which will be converted to permanent stormwater management facilities.
6. A schedule to establish the construction sequence of temporary and permanent practices and their timing relative to other construction activities.
7. An inspection and maintenance schedule for soil ESC facilities which describes maintenance activities to be performed.
8. Dewatering practices for the installation of underground utilities.

A sample ESC checklist is contained in Appendix G.

III. Construction of ESCs

Effective erosion and sediment control requires good construction site management. Proper management can reduce the need for maintenance of structural controls, regrading of severely eroded areas, and reconstruction of controls that were improperly or poorly constructed or maintained. Good construction site management also results in efficient use of manpower, financial savings and improves the overall site appearance.

Good construction site management includes the following:

1. Physically mark limits of land disturbance on the site with tape, signs, or orange construction fence, so that workers can see the areas to be protected.
2. Divert offsite runoff from highly erodible soils and steep slopes to stable areas.
3. Clear only what is required for immediate construction activity. Large projects should be cleared and graded as construction progresses. Areas exceeding two acres in size should not be disturbed without a sequencing plan that requires practices to be installed and the soil stabilized, as disturbance beyond the two acres continues. Mass clearings and grading of the entire site should be avoided.
4. Restabilize disturbed areas as soon as possible after construction is completed. On sites greater than two acres, waiting until all disturbed areas are ready for seeding is unacceptable. Fourteen days shall be the maximum exposure period. Maintenance must be performed as necessary to ensure continued stabilization. Except as noted below, all sites shall be seeded and stabilized with erosion control materials, such as straw mulch, jute mesh, or excelsior, including areas where construction has been suspended or sections completed:
 - a. For active construction areas such as borrow or stockpile areas, roadway improvements and areas within 50 ft. of a building under construction, a perimeter sediment control system consisting, for example, of silt fencing or hay bales, shall be installed and maintained to contain soil. Exposed disturbed areas adjacent to a conveyance that provides rapid offsite discharge of sediment, such as a cut slope at an entrance, shall be covered with plastic or geotextile to prevent soil loss until it can be stabilized. Stabilized construction entrances will be maintained to control vehicle tracking material off site.
 - b. On the cut side of roads, ditches shall be stabilized immediately with rock rip-rap or other non-erodible liners (e.g. Rolled Erosion Control Products), or where appropriate, vegetative measures such as sod. Refer to Section 5 for appropriate considerations.
 - c. Permanent seeding should optimally be undertaken in the spring from March through May, and in late summer and early fall from September to October 15. During the peak summer months and in the fall after October 15, when seeding is found to be impracticable, an appropriate temporary mulch shall be applied. Permanent seeding may be undertaken during the summer if plans provide for adequate watering. Temporary seeding with rye can be utilized through November.

d. All slopes steeper than 3:1 (h:v), or 33.3%, as well as perimeter dikes, sediment basins or traps, and embankments shall, upon completion, be immediately stabilized with sod, seed and anchored straw mulch, or other approved stabilization measures (RECP). Areas outside of the perimeter sediment control system shall not be disturbed. Maintenance shall be performed as necessary to ensure continued stabilization.

e. Temporary sediment trapping devices shall not be removed until permanent stabilization is established in all contributory drainage areas. Similarly, stabilization shall be established prior to converting sediment traps/basins into permanent (post-construction) stormwater management practices.

5. Where temporary work roads or haul roads cross stream channels, adequate waterway openings shall be constructed using spans, culverts, washed rock backfill, or other acceptable, clean methods that will ensure that road construction and their use do not result in turbidity and sediment downstream. All crossing activities and appurtenances on streams regulated by Article 15 of the Environmental Conservation Law shall be in compliance with a permit issued pursuant to Article 15 of the ECL.
6. Make sure that all contractors and sub-contractors understand the ESC plan and sign the certification statement required by NYSDEC GP.
7. Designate responsibility for the ESC plan to one individual. This person shall be named in the Notice of Intent.
8. An ESC plan inspection program meeting the requirements of the NYSDEC GP, is necessary to determine when ESC measures need maintenance or repair. Pay particular attention to inspections required after rainfall. The inspection program shall also state the completion of identified repair and maintenance items.

Predicting Soil Losses

Predictions of soil loss is a planning tool. The predictions guide planners on the degree of erosion and sediment control at specific sites. Predicted soil losses also create an awareness among developers, local governments and others of the urgent need to install erosion and sediment control measures before, during and after construction activity.

Soil losses can be predicted for a whole year, part of a year or on the basis of rainfall amounts. The Revised Universal Soil Loss Equation (RUSLE) is used to estimate soil losses on construction sites from sheet and rill erosion. The equation uses site-specific rainfall intensity, soil erodibility and slope factors (see Appendix A). Other soil losses, such as gully erosion or wind erosion, are calculated separately.

There are over 430 different soils in New York State. These soils are made up of different percentages of gravel, sand, silt, clay and organic material. Thus, they erode at different rates. Table 2.2 at the end of this section provides a general characterization of erosion risk based on slope and associated physical factors.

Estimating Sediment Yield

Sediment yield involves both soil erosion on the site and the transport mechanism acting to carry the eroded material off the site.

Where sediment yields from a developing area are needed for estimating sediment basin design volumes, the method in Appendix A can be used for determining the amount of the eroded material that will leave the site as sediment.

Professional Certification

CPESC, Inc. administers a program to evaluate individuals as a Certified Professional in Erosion and Sediment Control (CPESC). Such individuals have acquired specific training and passed an examination in ESC. These individuals are generally available for site design and/or implementation oversight. In addition, state licensed engineers, landscape architects and soil scientists also provide the technical skills required to design plans and inspect construction sites.

ESC Ordinances and Subdivision Regulations

ESC Laws and related regulations protect the public welfare by saving money on public infrastructure and maintenance, increasing public safety, protecting water supplies (including groundwater), providing flood control protection and preserving aquatic and riparian wildlife habitat. An ESC law accomplishes this by regulating and controlling the design, construction, use, and maintenance of any development or other activity that disturbs or breaks the topsoil or results in the movement of earth on land. ESC laws consist of permit application and review, and they typically require an erosion and sediment control plan. Municipalities can ensure successful construction and maintenance of ESC measures by adopting and implementing a law that requires prior review and approval of ESC plans, provides ESC design criteria, and includes an inspection and enforcement procedure.

STEPS IN THE SELECTION AND DESIGN OF CONTROL MEASURES

The following text relates to the planning flow charts on pages 2.6, 2.7 and 2.8.

In the erosion and sediment control process, site designs must be prepared to address erosion control and then sediment control. Erosion control is accomplished by controlling runoff and then stabilizing soil. After erosion control has been planned, sediment control can then be developed.

Step 1: Identify Control Methods—Three basic methods are used to control soil movement on construction sites: runoff control, soil stabilization, and sediment control. **CONTROLLING EROSION SHALL BE THE FIRST LINE OF DEFENSE.** Runoff control and soil stabilization can be used to control erosion. Controlling erosion is very effective for small-disturbed areas such as single lots or small areas of a disturbance.

Sediment control may be necessary on large developments where mass grading is planned, where it is harder or impractical to control erosion, and where sediment particles are relatively large. A minimum of cost for erosion and sediment control is usually accomplished by using a combination of vegetative and structural erosion control and sedimentation control measures.

Step 2: Identify Resources and Potential Problem Areas—Resources need to be identified prior to initiating an ESC plan. These resources include, but are not limited to, receiving waters, tributaries to public water supplies, beaches and other concentrated recreational areas, wetlands, trees, vegetative buffers, steep slopes and cultural resources. Areas where erosion is to be controlled will usually fall into categories of slopes, graded areas or drainage ways. Slopes include graded rights-of-way, stockpile areas, and all cut or fill slopes. Graded areas include all stripped areas other than slopes. Drainage ways are areas where concentrations of water flow naturally or artificially, and the potential for gully erosion is high. Problem areas where sediment is to be controlled fall into categories of large or small drainage areas. Small areas are usually 1 acre or less while large areas are greater than 1 acre.

Step 3: Identify Required Strategy—The third step in erosion and sediment control planning is to follow the planning matrix from the problem area to the strategy that can be taken to solve the problem. Strategies can be used individually or in combination. For example, if there is a cut slope to be protected from erosion, the strategies may be to protect the ground surface, divert water from the slope, or

shorten it. Any combination of these strategies can be used. If no rainfall except that which falls on the slope has the potential to cause erosion, and if the slope is relatively short, protecting the soil surface is often all that is required to solve the problem.

Step 4: Identify Control Measure Group—Once required strategies are identified, the planning flow chart leads to the group or groups of control measures that will accomplish one strategy. Control measures within each group have similar purpose, scope, application, design, criteria, standard plans, and construction specifications. Therefore, any measure within a group may solve the problem in question.

Step 5: Design Specific Control Measures—The final step in erosion and sediment control planning is accomplished by completing final design. This involves applying any control measure within a group to solve the specific erosion and sediment control problem. From descriptions given to the right of each control measure in the ESC planning matrix (Table 2.1), the one measure which is most economical, practical, efficient, and adaptable to the site should be chosen.

Step 6: Winter Operations—If construction activities continue during winter, access points should be enlarged and stabilized to provide for snow stockpiling. In addition, a snow management plan should be prepared with adequate storage and control of meltwater. A minimum 25 foot buffer shall be maintained from perimeter controls such as silt fence. In high resource protection areas, silt fence shall be replaced with perimeter dikes, swales, or other practices resistant to the forces of snow loads. Keep drainage structures open and free of snow and ice dams. Inspection and maintenance are necessary to ensure the function of these practices during runoff events.

Once the specific control measure has been selected, the plan key symbol given in the flow chart must be placed on the erosion and sediment control site plan to show where the control measure will be used. Standardized design, plan, and construction specification sheets must then be completed for each control measure. This completes the planning for erosion control and soil stabilization as part of the total natural resource plan.

Figure 2.1
Planning Flow Chart—Runoff Control

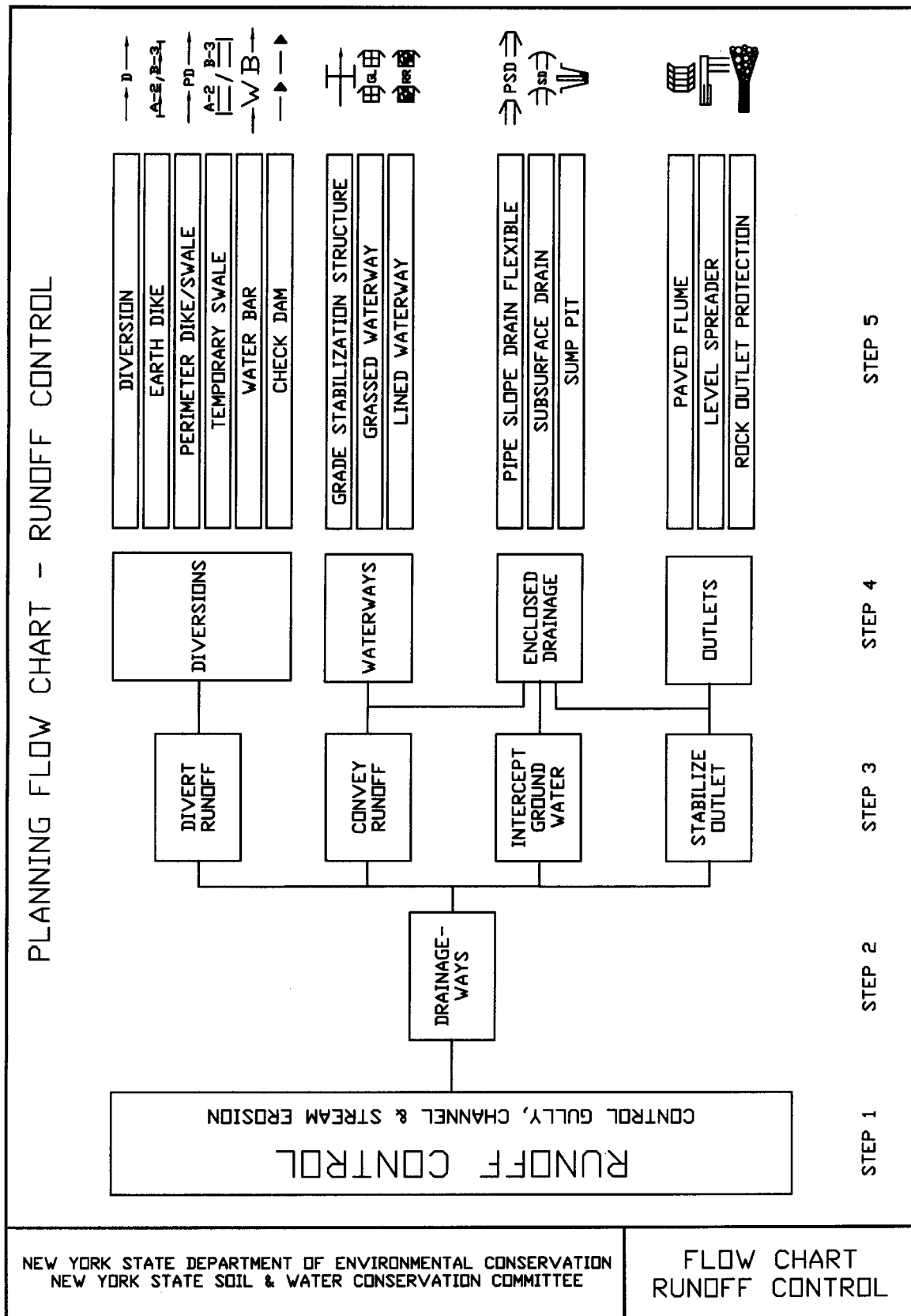

Figure 2.2
Planning Flow Chart—Soil Stabilization

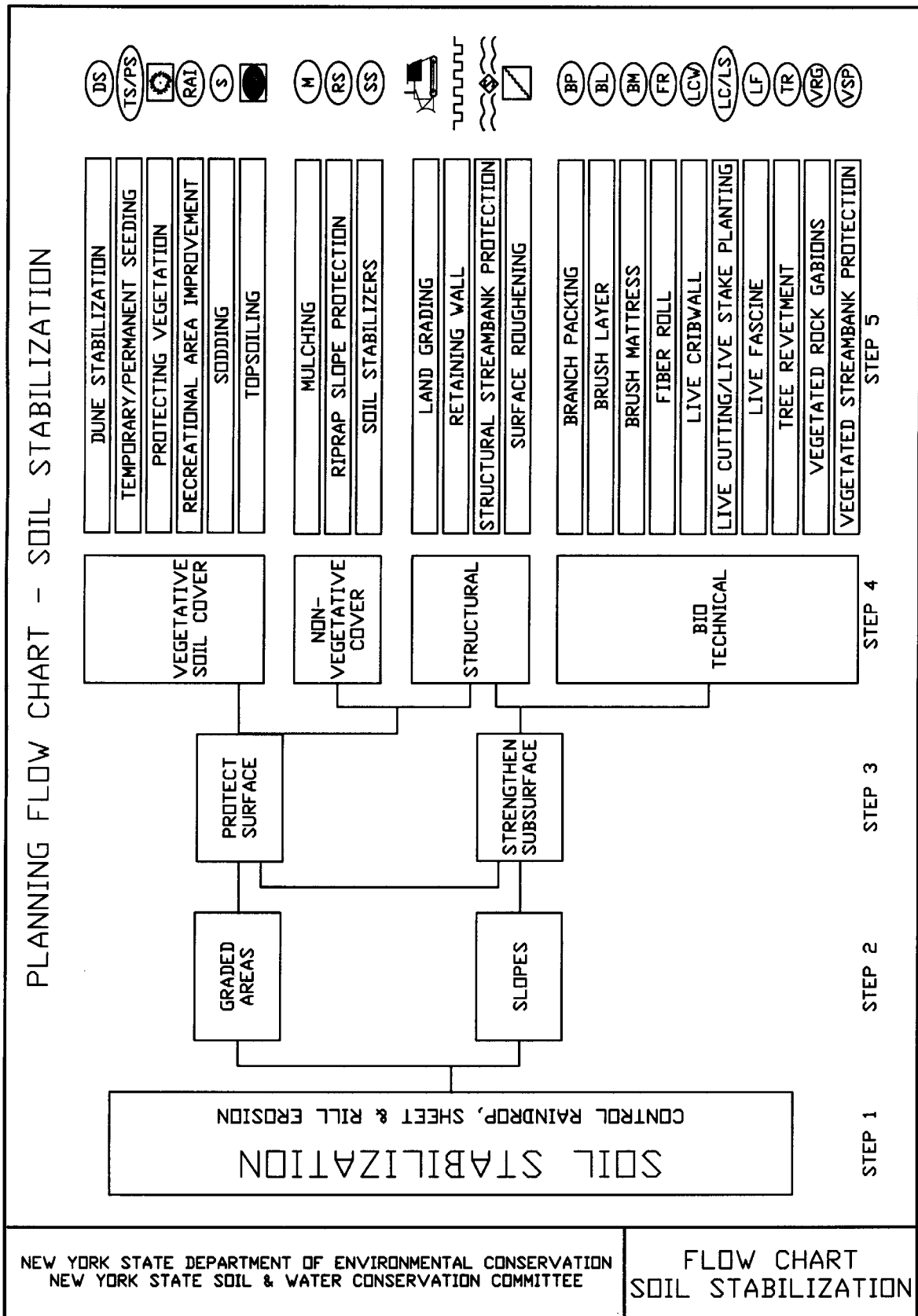

Figure 2.3
Planning Flow Chart—Sediment Control

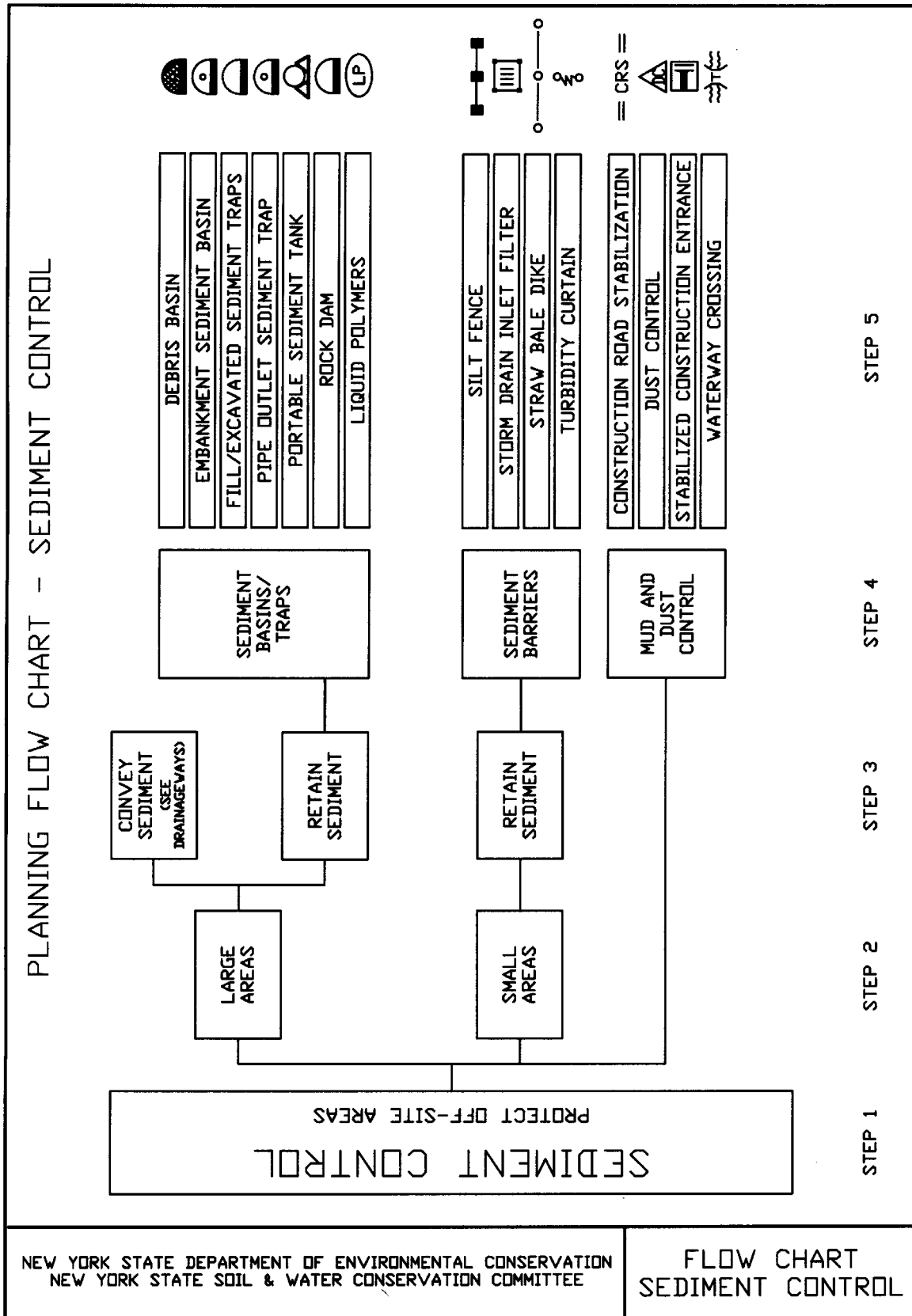

Table 2.1
Erosion and Sediment Control Practices Matrix

<u>Practice</u>	<u>Primary Purpose</u>	<u>Site Characteristics</u>	<u>Estimated Design Life</u>	<u>Associated Practices</u>
Brush Matting	Stabilize soil; prevent erosion	Stream bank slopes	5-10 years	Rock slope protection, structural streambank protection, subsurface drain
Check Dam	Control runoff	Drainage area \leq 2 Ac.	1 year	Lined waterway, rock outlet protection
Construction Road Stabilization	Control sediment	All construction routes	2 years	Dust control, temporary swales, temporary or permanent seeding
Debris Basin	Capture sediment	Maximum drainage area = 200 Ac.	Up to 25 years	Sediment basin
Diversion	Intercept and divert runoff	Minimum 10 year design Q	10-25 years	Permanent seeding, rock outlet protection, level spreader, sediment basin
Dune Stabilization	Stabilize sand dunes	Sand dune reinforcement	5-10 years	_____
Dust Control	Stabilize soil	Access points, construction roads	Site specific	Stabilized construction entrance, construction road stabilization
Earth Dike	Control runoff	Drainage area \leq 10 Ac.	1 year	Sediment trap, rock outlet protection, storm drain inlet
Grade Stabilization Structure	Prevent erosion	Minimum design Q = 10 yr. 24 hr.	10 + years	Permanent seeding, rock slope protection structural streambank protection
Grassed Waterway	Convey runoff	Minimum 10 year design Q	Min. 10 years	Rock outlet protection, vegetated waterways, sediment basin, level spreader
Land Grading	Stabilize soil	Site specific shaping	Permanent	Topsoiling, subsurface drain, seeding
Level Spreader	Discharge runoff	10 year Q \leq 30 cfs; outlet $<$ 10%	1 year	Diversion, grassed waterway, temporary swales
Lined Waterway (rock materials)	Convey runoff	Minimum design Q = 10 yr. 24 hr.	Min. 10 years	Rock outlet protection, subsurface drain
Mulching	Stabilize soil	Site specific	1-2 years	Permanent seeding, recreation area improvement
Paved Channel (concrete)	Convey runoff	Minimum design Q = 10 yr. 24 hr.	Min. 10 years	Rock outlet protection, subsurface drain
Paved Flume	Convey runoff	Minimum design Q = 10 yr. 24 hr.	10 years	Rock outlet protection

Table 2.1 (cont'd)
Erosion and Sediment Control Practices Matrix

<u>Practice</u>	<u>Primary Purpose</u>	<u>Site Characteristics</u>	<u>Estimated Design Life</u>	<u>Associated Practices</u>
Perimeter Dike/Swale	Divert runoff	Drainage area ≤ 5 Ac.	1 year	Sediment trap, level spreader, temporary seeding
Pipe Slope Drain	Convey runoff down slope	Drainage area ≤ 5 Ac.	1 year	Rock outlet protection
Portable Sediment Tank	Retain sediment	16 times pump discharge	2 years	Sediment trap, sediment basin
Protecting Vegetation	Preserve existing vegetation	Site specific	1-10 years	Recreation area improvement
Recreation Area Improvement	Protect areas/soils	Site specific	Permanent	Permanent seeding, mulching, topsoiling
Retaining Wall	Stabilize soil	Site specific constraints	10+ years	Rock slope protection, permanent seeding, sub-surface drain
Riprap Slope Protection	Stabilize soil, prevent erosion	Max. 1:5 to 1 slope	10 years	Lined waterway, rock outlet stabilization, structural streambank protection
Rock Dam	Capture sediment	Drainage area ≤ 50 Ac.	3 years	Debris basin, sediment basin
Rock Outlet Protection	Prevent erosion	Rock varies with pipe discharge	10+ years	Diversion, grassed waterway, sediment basin, sediment traps
Sediment Basin	Capture sediment	Drainage area ≤ 100 Ac.	3 years	Rock outlet protection, temporary seeding
<u>Sediment Traps</u>				
I. Pipe Outlet	Trap sediment	Drainage area ≤ 5 Ac.	2 years	Sediment basin, debris basin
II. Grass Outlet	Trap sediment	Drainage area ≤ 5 Ac.	1 year	Rock outlet protection
III. Storm Inlet	Trap sediment	Drainage area ≤ 3 Ac.	1 year	Rock outlet protection
IV. Swale	Trap sediment	Drainage area ≤ 2 Ac.	1 year	Rock outlet protection
V. Stone Outlet	Trap sediment	Drainage area ≤ 5 Ac.	2 years	Rock outlet protection
VI. Riprap Outlet	Trap sediment	Drainage area ≤ 15 Ac.	2 years	Rock outlet protection
Seeding, Temporary	Stabilize soil	Site specific	1-2 years	Surface roughening, topsoiling, sodding
Seeding, Permanent	Stabilize soil	Site specific	Permanent	Surface roughening, topsoiling, sodding

Table 2.1 (cont'd)
Erosion and Sediment Control Practices Matrix

<u>Practice</u>	<u>Primary Purpose</u>	<u>Site Characteristics</u>	<u>Estimated Design Life</u>	<u>Associated Practices</u>
Silt Fence	Control sediment	2:1 slopes maximum 50 ft. spacing	1 year	Straw bale dike
Sodding	Stabilize soil	Need quick cover, aes- thetics	Permanent	Inlet protection, top- soiling, permanent seeding
Stabilized Construction Entrance	Control sediment	Access points	2 years	Filter fence, construc- tion road stabilization
<u>Storm Drain Inlet Protection</u>				
I. Excavated	Trap sediment	Drainage area ≤ 1 Ac.	1 year	Sediment traps, storm drain diversion
II. Filter Fabric	Trap sediment	Drainage area ≤ 1 Ac.	6 months	Sediment traps, storm drain diversion
III. Stone and Block	Trap sediment	Drainage area ≤ 1 Ac.	6 months	Sediment traps, storm drain diversion
IV. Curb	Trap sediment	Drainage area ≤ 1 Ac.	6 months	Sediment traps, storm drain diversion
Straw Bale Dike	Control sediment	2:1 slopes maximum 25 ft. spacing	3 months	Silt fence
<u>Streambank Protection</u>				
I. Structural	Prevent erosion	Minimum 10 yr. de- sign Q; velocity > 6 fps	10 years	Rock slope protection
II. Vegetative	Prevent erosion	Minimum 10 yr. de- sign Q; velocity < 6 fps	10 years	Structural streambank protection
Subsurface Drain	Intercept and convey drainage water	Drainage Coefficient— 1”	10 years	Rock outlet protec- tion, land grading, retaining wall
Sump Pit	Control sediment	Site specific	6 months	Sediment trap, sedi- ment basin
Surface Roughening	Stabilize soil	Construction slopes	Permanent	Temporary seeding, permanent seeding, mulching
<u>Temporary Access Waterway Crossings</u>				
I. Temporary Access Bridge	Prevent sediment	8 ft. centerline piers	2 years	Rock slope protection
II. Temporary Access Culvert	Prevent sediment	Minimum 12 in.; 40 ft. length	2 years	Structural streambank protection
III. Temporary Access Road	Prevent sediment	Stream banks < 4 ft.	1 year	Structural streambank protection
Temporary Storm Drain Diversion	Divert runoff	On site drainage area > 50% total	1 year	Sediment trap/basin
Temporary Swale	Divert runoff	Drainage area ≤ 10 Ac.	1 year	Sediment traps, storm drain inlets, sediment basin, level spreader

Table 2.1 (cont'd)
Erosion and Sediment Control Practices Matrix

<u>Practice</u>	<u>Primary Purpose</u>	<u>Site Characteristics</u>	<u>Estimated Design Life</u>	<u>Associated Practices</u>
Topsoiling	Provide growing conditions	Poor site soil characteristics	Permanent	Surface roughening, temporary seeding, permanent seeding
Turbidity Curtain	Control sediment	Calm water	Generally < 1 month	Sediment traps, basins
Vegetating Waterways	Stabilize soil	Site specific	Permanent	Grassed waterways, permanent seeding
Water Bars	Divert runoff	Slope areas < 100 ft. width	2 years	Rock outlet protection, level spreader
Wattling	Stabilize soil	Maximum 1.5:1 slopes	10 years	Diversion, subsurface drain, temporary swale

Table 2.2
Erosion Risk

<u>Soil Type and Parameters</u>	<u>Slope %</u>		
	0-5	5-15	>15
Gravelly, K< 0.35 Non-cohesive PI= NP, Fines: 0-10%	Low	Low	Med
Sandy, K> 0.35 PI= NP, Fines: 0-30%	Med	High	High
Silty, K> 0.35 PI= NP, Fines: 50+%	Med	High	Very High
Clay, K< 0.35 Cohesive PI=7+, Fines: 50+%	Low	Med	High
Despersive Clay Soils	High	Very High	Extreme

Note: There are other factors that contribute to erosion, such as slope length and rainfall intensity and duration. Also, even though there may be low erosion risk, there can be a high risk to water quality when the soil disturbance is close to water resources.

References

1. Northeastern Illinois Soil and Sedimentation Control Steering Committee. October 1981. Procedures and Standards for Urban Soil Erosion and Sediment Control in Illinois.

Page Intentionally Left Blank

SECTION 3 VEGETATIVE MEASURES FOR EROSION AND SEDIMENT CONTROL

CONTENTS

	<u>Page</u>
List of Tables	
List of Figures	
Basic Principles of Vegetative Measures used for Erosion and Sediment Control.....	3.1
Temporary Critical Area Plantings.....	3.3
Permanent Critical Area Plantings.....	3.5
Recreation Area Improvement.....	3.9
Establishing grasses for lawns, playgrounds, parks, athletic fields, picnic areas, camping areas, passive recreation areas, and similar areas.....	3.9
Maintaining grasses.....	3.11
Establishing trees, shrubs, and vines.....	3.11
Pruning and thinning.....	3.13
Protecting trees in heavy use areas.....	3.13
Vegetating Waterways.....	3.23
Topsoiling.....	3.27
Mulching.....	3.29
Stabilization with Sod.....	3.33
Vegetative Stabilization of Sand and Gravel Pits.....	3.35
Protecting Vegetation During Construction.....	3.37
Vegetating Sand Dunes and Tidal Banks.....	3.39
References	

Section prepared by:

Frederick B. Gaffney, former Conservation Agronomist
USDA—Natural Resources Conservation Service,
Syracuse, New York

and

John A. Dickerson, Plant Materials Specialist
USDA—Natural Resources Conservation Service,
Syracuse, New York

List of Tables

<u>Table</u>	<u>Title</u>	<u>Page</u>
3.1	Permanent Critical Area Planting Mixture Recommendations.....	3.7
3.2	Recreation Turfgrass Seed Mixtures.....	3.10
3.3	Trees Suitable for Landscape and Conservation Plantings in New York.....	3.14
3.4	Susceptibility of Tree Species to Compaction.....	3.21
3.5	Size and Weight of Earth Ball Required to Transplant Wild Stock.....	3.21
3.6	Maximum Permissible Velocities for Selected Seed Mixtures.....	3.25
3.7	Guide to Mulch Materials, Rates, and Uses.....	3.30
3.8	Mulch Anchoring Guide.....	3.31
3.9	Vegetative Treatment Potential for Eroding Tidal Shorelines	3.42

List of Figures

<u>Figure</u>	<u>Title</u>	<u>Page</u>
3.1	New Tree Planting Procedure.....	3.12
3.2	Rill Maintenance Measures.....	3.26
3.3	Combination of Sand Fence and Vegetation for Dune Building.....	3.41
3.4	Typical Cross Section Created by a Combination of Sand Fence and Vegetation.....	3.41
3.5	American Beachgrass Information Sheet	3.43
3.6	Cordgrass Information Sheet.....	3.44

VEGETATIVE MEASURES FOR EROSION AND SEDIMENT CONTROL

Erosion is the gradual wearing away of the land surface as a result of uncontrolled wind and water energy.

Sedimentation is the result of transport and delivery of eroded soil particles, deposited at some point. Erosion and sediment control is a complex interaction of soils, engineering water management, agronomic and horticultural practices. Decisions for resolving erosion conditions, both on site and within the upper watershed, are formulated based on surface and subsurface water, soil material, climatic conditions, and anticipated land use. Creating a stable slope is necessary prior to vegetating. Sloughing and slumping are not helpful in establishing a uniform protective cover.

General planning considerations for vegetating a steep slope will include evaluating the soil. Factors such as soil texture and steepness affect the stability of the slope. Texture also influences the permeability and water holding capacity of the soil. Many slopes are stripped of topsoil during the construction phase, leaving an infertile, compacted soil surface, void of valuable organic matter. Topsoil must be reapplied. Overly compacted slopes should be decompact with appropriate equipment. Soil pH and nutrient level are determined by obtaining a representative soil sample for analysis from an accredited lab. Appropriate plants are selected to meet the final slope and soil conditions for the site.

Liming material sold in New York varies considerably in several ways. The mineral content (calcium and magnesium) of the limestone may be high or low, the fineness or particle sizes vary between suppliers, and the cost varies greatly. Two types of limestone are sold. The most common is limestone high in calcium. Dolomitic limestone contains magnesium (Mg) and calcium (Ca). Limestone sold in NY varies from 0 to 20% Mg while the calcium content of lime varies from 14.7% to 51.5%. Particle size determines how rapidly the calcium and magnesium will react with the acid in the soil. The finer the particle sizes, the quicker the reaction.

When purchasing agricultural limestone, one should state on the order that the amount should be adjusted to 100% effective neutralizing value (ENV). This is the way to compare materials as it adjusts for the reactive Ca and Mg and the particle size. The ENV is stated as the ratio needed to convert a limestone recommendation to 100% ENV. Thus, if the recommendation is 4 tons/acre of 100% ENV lime and the lime being used had an 80% ENV (1/ENV = 1.25), 4 times 1.25 or 5 tons/acre would be required.

The amount of limestone needed can be estimated by using the table below. A soil test is the only way to determine the

soil pH. This table is very general, but it is useful for planning.

General lime guidelines (at 100% ENV)

<i>Initial Soil pH</i>	<i>Sands</i>	<i>Sandy Loams</i>	<i>Loams and Silt Loams</i>	<i>Silty Clay Loams</i>
T/A of lime¹				
4.5	2.5	6.0	9.5	13.0
4.6-4.7	2.5	6.0	9.0	12.5
4.8-4.9	2.5	5.5	8.5	12.0
5.0-5.1	2.0	5.0	7.5	10.5
5.2-5.3	1.5	4.0	6.5	8.5
5.4-5.5	1.0	3.0	4.0	6.0
5.6-5.7	1.0	2.0	3.0	4.5
5.8-5.9	0.7	1.5	2.5	3.5
6.0-6.1	0.6	1.5	2.0	3.0
6.2-6.3	0.4	1.0	1.5	2.0
6.~6.5	0.3	0.7	1.0	1.5
6.6-6.7	0.2	0.5	0.7	1.0

Lime guidelines are in tons per acre and are based on a plow depth of 8.0 inches. Correct rate if plowing to a different depth.

REFERENCE: Cornell Cooperative Extension. 2003 Cornell Guide for Integrated Field Crop Management, Pg. 32.

Fertilizer is sold with an analysis printed on the tag or bag. The first number is the percent of nitrogen (N), the second is phosphorus (P), and the third is potassium (K). Other elements are sometimes included and are listed with these basic three components. For example, a forty pound bag of 5-10-5 contains 2 lbs. N, 4 lbs. P (as P₂O₅), and 2 lbs. of K (as K₂O). Select an appropriate analysis to meet the nutrients required for the specific site. Always apply as closely as possible the required amount of fertilizer to meet the requirements of the site. Adding surplus nitrogen may cause pollution of drinking water and saltwater ecosystems. Excessive phosphorus may accelerate the aging process of freshwater ecosystems. Excessive amounts of N and K₂O may result in 'burning' the grass and killing it.

Water management on and above potentially eroding sites is extremely important. Large watersheds above a site may require extensive water control measures. Water flow paths must be controlled to allow the safe delivery of the water to an outlet to the side or bottom of the slope. Shallow ditches or diversions across the slope and above the area to be seeded is an effective method of avoiding wash-out of the seed and soil. Diversions may be constructed at a point where surface runoff water is intercepted and carried away from the slope and to a safe outlet. On large slopes,

benching may be necessary for bench drains or future maintenance (see standard for Land Grading). Subsurface drainage is frequently included to prevent long term saturated soil conditions and sloughing.

Conservation plantings need to effectively hold soil and control erosion, and they should enhance and blend with their surroundings. Mature plant size, form, and appearance must be considered along with their functionality to match the anticipated land use. Basic erosion control is accomplished by providing cover to the soil surface utilizing plants and/or mulch. It is the system of seedbed preparation, soil amendments, plant selection, proper timing of planting, and mulching that will optimize the chances of success. Characteristics of grasses such as low growth, horizontal above and below ground stems, leafy growth, and many fine roots for binding soil particles, make them the primary choice for vegetating slopes. Once the grass type is selected, then appropriate forbs, shrubs, or trees may be added to meet site conditions. The use of appropriate mulches will depend on site criteria and should be carefully evaluated. Although some materials are costly, they may prevent the need for more costly reshaping and reseeding.

Selection of proper vegetative materials for site stabilization is critical for environmental success. Species should be selected that are not considered “invasive.” A primary list of invasive plants can be found at the website of the Invasive Plant Council of New York State (<http://www.ipcnys.org>). Any species not on this list but considered suspect should be verified at the appropriate regional or local level for acceptance.

STANDARD AND SPECIFICATIONS FOR TEMPORARY CRITICAL AREA PLANTINGS



Definition

Providing erosion control protection to a critical area for an interim period. A critical area is any disturbed, denuded slope subject to erosion.

Purpose

To provide temporary erosion and sediment control. Temporary control is achieved by covering all bare ground areas that exist as a result of construction or a natural event.

Conditions Where Practice Applies

Temporary seedings may be necessary on construction sites to protect an area, or section, where final grading is complete, when preparing for winter work shutdown, or to provide cover when permanent seedings are likely to fail due to mid-summer heat and drought. The intent is to provide temporary protective cover during temporary shutdown of construction and/or while waiting for optimal planting time.

Criteria

Water management practices must be installed as appropriate for site conditions. The area must be rough graded and slopes physically stable. Large debris and rocks are usually removed. Seedbed must be seeded within 24 hours of disturbance or scarification of the soil surface will be necessary prior to seeding.

Fertilizer or lime are not typically used for temporary seedings.

IF: Spring or summer or early fall, then seed the area with ryegrass (annual or perennial) at 30 lbs. per acre (Approximately 0.7 lb./1000 sq. ft. or use 1 lb./1000 sq. ft.).
IF: Late fall or early winter, then seed Certified 'Aroostook' winter rye (cereal rye) at 100 lbs. per acre (2.5 lbs./1000 sq. ft.).

Any seeding method may be used that will provide uniform application of seed to the area and result in relatively good soil to seed contact.

Mulch the area with hay or straw at 2 tons/acre (approx. 90 lbs./1000 sq. ft. or 2 bales). Quality of hay or straw mulch allowable will be determined based on long term use and visual concerns. Mulch anchoring will be required where wind or areas of concentrated water are of concern. Wood fiber hydromulch or other sprayable products approved for erosion control (nylon web or mesh) may be used if applied according to manufacturers' specification. Caution is advised when using nylon or other synthetic products. They may be difficult to remove prior to final seeding.

STANDARD AND SPECIFICATIONS FOR PERMANENT CRITICAL AREA PLANTINGS



Definition

Establishing grasses with other forbs and/or shrubs to provide perennial vegetative cover on disturbed, denuded, slopes subject to erosion.

Purpose

To reduce erosion and sediment transport.

Conditions Where Practice Applies

This practice applies to all disturbed areas void of, or having insufficient, cover to prevent erosion and sediment transport. See additional standards for special situations such as sand dunes and sand and gravel pits.

Criteria

All water control measures will be installed as needed prior to final grading and seedbed preparation. Any severely compacted sections will require chiseling or disking to provide an adequate rooting zone, to a minimum depth of 12". The seedbed must be prepared to allow good soil to seed contact, with the soil not too soft and not too compact. Adequate soil moisture must be present to accomplish this. If surface is powder dry or sticky wet, postpone operations until moisture changes to a favorable condition. If seeding is accomplished within 24 hours of final grading, additional scarification is generally not needed, especially on ditch or stream banks. Remove all stones and other debris from the surface that are greater than 4 inches, or that will interfere with future mowing or maintenance.

Soil amendments should be incorporated into the upper 2 inches of soil when feasible. **The soil should be tested to determine the amounts of amendments needed.** Apply ground agricultural limestone to attain a pH of 6.0 in the upper 2 inches of soil. If soil must be fertilized before

results of a soil test can be obtained to determine fertilizer needs, apply commercial fertilizer at 600 lbs. per acre of 5-10-10 or equivalent. If manure is used, apply a quantity to meet the nutrients of the above fertilizer. This requires an appropriate manure analysis prior to applying to the site. Do not use manure on sites to be planted with birdsfoot trefoil or in the path of concentrated water flow.

Seed mixtures may vary depending on location within the state and time of seeding. Generally, warm season grasses should only be seeded during early spring, April to May. These grasses are primarily used for vegetating excessively drained sands and gravels. See Standard and Specification for Sand and Gravel Mine Reclamation. Other grasses may be seeded any time of the year when the soil is not frozen and is workable. When legumes such as birdsfoot trefoil are included, spring seedings are preferred. See Table 3.1 "Permanent Critical Area Planting Mixture Recommendations" for additional seed mixtures.

General Seed Mix:

¹ add inoculant immediately prior to seeding

	<u>Variety</u>	<u>lbs./acre</u>	<u>lbs/1000 sq. ft.</u>
Birdsfoot trefoil ¹ <u>OR</u>	Empire/Pardee	8 ²	0.20
Common white clover ¹	Common	8	0.20
<u>PLUS</u>			
Tall fescue	KY-31/Rebel	20	0.45
<u>PLUS</u>			
Redtop <u>OR</u>	Common	2	0.05
Ryegrass (perennial)	Pennfine/Linn	5	0.10

² Mix 4 lbs each of Empire and Pardee OR 4 lbs of Birdsfoot and 4 lbs white clover per acre.

Time of Seeding: The optimum timing for the general seed mixture is early spring. Permanent seedings may be made any time of year if properly mulched and adequate moisture is provided. Late June through early August is not a good time to seed, but may facilitate covering the land without additional disturbance if construction is completed. Portions of the seeding may fail due to drought and heat. These areas may need reseeding in late summer/fall or the following spring.

Method of seeding: Broadcasting, drilling, cultipack type

seeding, or hydroseeding are acceptable methods. Proper soil to seed contact is key to successful seedings.

Mulching: Mulching is essential to obtain a uniform stand of seeded plants. Optimum benefits of mulching new seedings are obtained with the use of small grain straw applied at a rate of 2 tons per acre, and anchored with a netting or tackifier. See the mulch standard and specification for choices and requirements.

Irrigation: Watering may be essential to establish a new seeding when a drought condition occurs shortly after a new seeding emerges. Irrigation is a specialized practice and care must be taken not to exceed the application rate for the soil or subsoil. When disconnecting irrigation pipe, be sure pipes are drained in a safe manor, not creating an erosion concern.

Table 3.1
Permanent Critical Area Planting Mixture Recommendations

Seed mixture	Variety	Rate in lbs. per acre	Rate in lbs. Per 1000 sq. ft.
Mix #1			
Creeping red fescue	Ensylva, Pennlawn, Boreal	10	.25
Perennial ryegrass	Pennfine, Linn	10	.25
*This mix is used extensively for shaded areas.			
Mix #2			
Switchgrass	Shelter, Pathfinder, Trailblazer, or Blackwell	20	.5
*This rate is in pure live seed, this would be an excellent choice along the upland edge of a wetland to filter runoff and provide wildlife benefits. In areas where erosion may be a problem, a companion seeding of sand lovegrass should be added to provide quick cover at a rate of 2 lbs. per acre (0.05 lbs. per 1000 sq. ft.).			
Mix #3			
Switchgrass	Shelter, Pathfinder, Trailblazer, or Blackwell	4	.1
Big bluestem	Niagara	4	.1
Little bluestem	Aldous or Camper	2	.05
Indiangrass	Rumsey	4	.1
Coastal panicgrass	Atlantic	2	.05
Sideoats grama	El Reno or Trailway	2	.05
Wildflower mix		.5	.01
*This mix has been successful on sand and gravel plantings. It is very difficult to seed without a warm season grass seeder such as a Truax seed drill. Broadcasting this seed is very difficult due to the fluffy nature of some of the seed, such as bluestems and indiangrass.			
Mix #4			
Switchgrass	Shelter, Pathfinder Trailblazer, or Blackwell	10	.25
Coastal panicgrass	Atlantic	10	.25
*This mix is salt tolerant, a good choice along the upland edge of tidal areas and roadsides.			
Mix #5			
Saltmeadow cordgrass (<i>Spartina patens</i>)—This grass is used for tidal shoreline protection and tidal marsh restoration. It is planted by vegetative stem divisions.			
'Cape' American beachgrass can be planted for sand dune stabilization above the saltmeadow cordgrass zone.			
Mix #6			
Creeping red fescue	Ensylva, Pennlawn, Boreal	20	.45
Tall fescue	KY 31, Rebel	20	.45
Perennial ryegrass	Pennfine, Linn	5	.10
Birdsfoot trefoil	Empire, Pardee	10	.45
*General purpose erosion control mix. Not to be used for a turf planting or play grounds.			

STANDARD AND SPECIFICATIONS FOR RECREATION AREA IMPROVEMENT



Definition

Establishing grasses, legumes, vines, shrubs, trees, or other plants, or selectively reducing stand density and trimming woody plants, to improve an area for recreation.

Purpose

To increase the attractiveness and usefulness of recreation areas and to protect the soil and plant resources.

Conditions Where Practice Applies

On any area planned for recreation use, lawns, and areas that will be maintained in a closely mowed condition.

Specifications

ESTABLISHING GRASSES (Turfgrass)

The following applies for playgrounds, parks, athletic fields, camping areas, picnic areas, passive recreation areas such as lawns, and similar areas.

1. Time of Planting

Fall planting is preferred. Seed after August 15. In the spring, plant until May 15.

If seeding is done between May 15 and August 15, irrigation may be necessary to ensure a successful seeding.

2. Site Preparation

- A. Install needed water and erosion control measures and bring area to be seeded to desired grades. A minimum of 4 in. topsoil is required.
- B. See Standard and Specification of Topsoiling.

- C. Prepare seedbed by loosening soil to a depth of 4-6 inches.
- D. Lime to a pH of 6.5.
- E. **Fertilize as per soil test** or, if soil must be fertilized before results of a soil test can be obtained to determine fertilizer needs, apply commercial fertilizer at 850 pounds of 5-10-10 or equivalent per acre (20 lbs/1,000 sq. ft.)
- F. Incorporate lime and fertilizer in top 2-4 inches of topsoil.
- G. Smooth. Remove sticks, foreign matter, and stones over 1 inch in diameter, from the surface. Firm the seedbed.

3. Planting

Use a cultipacker type seeder if possible. Seed to a depth of 1/8 to 1/4 inch. If seed is to be broadcast, cultipack or roll after seeding. If hyoseeded, lime and fertilizer may be applied through the seeder, and rolling is not practical.

4. Mulching

Mulch all seedings in accordance with Standard and Specifications for Mulching. Small grain straw is the best material.

5. Seed Mixtures

Select seed mixture for site conditions and intended use from Table 3.2.

6. Contact Cornell Cooperative Extension Turf Specialist for suitable varieties.

When Kentucky bluegrass is used, it is desirable to use two or more varieties in the seeding for disease resistance.

Turf-type tall fescues have replaced the old KY31 tall fescues. New varieties have finer leaves and are the most resistant grass to foot traffic. Do not mix it with fine textured grasses such as bluegrass and red fescue.

Common ryegrass and redtop, which are relatively short lived species, provide quick green cover. Improved lawn cultivars of perennial ryegrass provide excellent quality turf, but continue to lack winter hardiness.

Common white clover can be added to mixtures at the rate of 1-2 lbs/acre to help maintain green color during the dry summer period; however, they will not withstand heavy traffic. Avoid using around swimming areas as flowers attract bees which can be easily stepped on.

Table 3.2 Recreation Turfgrass Seed Mixture

Site - Use	Species (% by weight)	lbs/1,000 sq. ft.	lbs./acre
1. Sunny sites (well, moderately well, and somewhat poorly drained soils)			
a. Athletic fields and similar areas			
	80% Kentucky bluegrass blend.....	2.4-3.2	105-138
	20% perennial ryegrass.....	<u>0.6-0.8</u>	<u>25-37</u>
	<u>OR</u>	3.0-4.0	130-175
	(for southern and eastern NY)		
	50% Kentucky bluegrass.....	1.5-2.0	65-88
	50% perennial ryegrass.....	<u>1.5-2.0</u>	<u>65-87</u>
	<u>OR</u>	3.0-4.0	130-175
	100% Tall fescue, Turf-type, fine leaf.....	3.4-4.6	150-200
b. General recreation areas and lawns (Medium to high maintenance)			
	65% Kentucky bluegrass blend.....	2.0-2.6	85-114
	20% perennial ryegrass.....	0.6-0.8	26-35
	15% fine fescue.....	<u>0.4-0.6</u>	<u>19-26</u>
	<u>OR</u>	3.0-4.0	130-175
	100% Tall fescue, Turf-type, fine leaf.....	3.4-4.6	150-200
2. Sunny droughty sites - general recreation areas and lawns, low maintenance (somewhat excessively to excessively drained soils). Excluding Long Island.			
	65% fine fescue.....	2.6-3.3	114-143
	15% perennial ryegrass.....	0.6-0.7	26-33
	20% Kentucky bluegrass blend.....	<u>0.8-1.0</u>	<u>35-44</u>
	<u>OR</u>	4.0-5.0	175-220
	100% Tall fescue, Turf-type, fine leaf.....	3.4-4.6	150-200
3. Shady dry sites (well to somewhat poorly drained soils).			
	65% fine fescue.....	2.6-3.3	114-143
	15% perennial ryegrass.....	0.6-0.7	26-33
	20% Kentucky bluegrass blend.....	<u>0.8-1.0</u>	<u>35-44</u>
	<u>OR</u>	4.0-5.0	174-220
	80% blend of shade-tolerant Kentucky bluegrass.....	2.4-3.2	105-138
	20% perennial ryegrass.....	<u>0.6-0.8</u>	<u>25-37</u>
	<u>OR</u>	3.0-4.0	130-175
	100% Tall fescue, Turf-type, fine leaf.....	3.4-4.6	150-200
4. Shady wet sites (somewhat poor to poorly drained soils).			
	70% rough bluegrass.....	1.4-2.1	60-91
	30% blend of shade-tolerant Kentucky bluegrass.....	<u>0.6-0.9</u>	<u>25-39</u>
	<u>OR</u>	2.0-3.0	85-130
	100% Tall fescue, Turf-type, fine leaf.....	3.4-4.6	150-200

For varieties suitable for specific locations, contact Cornell Cooperative Extension Turf Specialist.

Reference: Thurn, M.C., N.W. Hummel, and A.M. Petrovic. Cornell Extension Pub. Info. Bulletin 185 Revised. HomeLawns Establishment and Maintenance. 1994.

7. Fertilizing—First Year

Apply fertilizer as indicated by the soil test three to four weeks after germination (spring seedlings). If test results have not been obtained, apply 1 pound nitrogen/1,000 square feet using a complete fertilizer with a 2-1-1 or 4-1-3 ratio. Summer and early fall seedlings, apply as above unless air temperatures are above 85°F for an extended period. Wait for cooler temperatures to fertilize. Late fall/winter seedlings, fertilize in spring.

8. Restrict Use

New seedlings should be protected from use for one full year to allow development of a dense sod with good root structure.

MAINTAINING GRASSES

1. Maintain a pH of 6.0 - 7.0.
2. Fertilize in late May to early June as follows with 10-10-10 analysis fertilizer at the rate of 10 lbs./1,000 sq. ft. and repeat in late August if sod density is not adequate. Avoid fertilizing when heat is greater than 85°F. Top dress weak sod annually in the spring, but at least once every 2 to 3 years. It is recommended to fertilize according to soil test analysis, after determining adequate topsoil depth exists.
3. Aerate compacted or heavily used areas, like athletic fields, annually as soon as soil moisture conditions permit. Aerate area six to eight times using a spoon or hollow tine type aerator. Do not use solid spike equipment.

4. Reseed bare and thin areas annually with original seed mix.

ESTABLISHING TREES, SHRUBS, AND VINES

1. Planting nursery stock

- A. Select species to serve the intended purpose. See Table 3.3, "Trees Suitable for Landscape and Conservation Plantings in New York." Where planting of trees is to be done in recreation areas, use those species resistant to compaction listed in Table 3.4, "Susceptibility of Tree Species to Compaction" whenever possible.
- B. Plant Materials
 - 1) Plants shall conform to the species, variety, size, number, and conditions as stated in a conservation plan or on a plant list shown on landscape drawings. "American Standard for Nursery Stock," by American Association of Nurserymen, shall be used to develop the plant list for landscape drawings and to check quality of plant materials.
 - 2) Durable, legible labels with the scientific and common name and cultivar shall be securely attached to plants, bundles of seedlings, containers, and/or flats.

C. Plant Protection

Prior to delivery, the trunk, branches, and foliage of the plants shall be sprayed with non-toxic antidesiccant, applied according to the manufacturers recommendations. This does not apply to state nursery seedlings.

D. Planting Time

Deciduous trees and shrubs: April 1 to June 1 and October 15 to December 15.

Evergreen trees and shrubs: April 1 to June 1 and September 1 to November 15.

E. Spacing

Plant all trees and shrubs well back from buildings to allow for mature crown size. The following are guides for planning:

Large trees:	50-60 feet apart
Small trees:	20-30 feet apart
Columnar species:	6-8 feet apart
Hedges:	1-4 feet apart
Shrubs:	For clumps, plan spacing so mature shrubs will be touching or overlapping by only 1 or 2 feet.

F. Site Preparation

- 1) Individual sites for planting seedlings can be prepared by scalping the sod away from a four foot square area where the seedling is to be planted.
- 2) All planting beds shall be cultivated to a depth of 8 inches, or chemically treated for weed control. Remove objectionable objects that will interfere with maintenance of site.

G. Planting

- 1) Plants shall be located as shown on plans and/or drawings and, where necessary, located on the site by stakes, flags or other means.
- 2) Prior to planting, remove galvanized wire basket securing root ball, untie and roll down burlap covering from around the stem.
- 3) The plants shall be set upright in holes as illustrated in Figure 3.1.
- 4) All plants shall be thoroughly watered on the same day of planting. Plants that have settled shall be reset to grade.

H. Wrapping

Immediately after planting, wrap deciduous tree trunks from the bottom to the first limb with a 4 inch wide bituminous impregnated, insect resistant tape or paper manufactured for that purpose. Tie with jute (bag strings) at top and bottom. The wrap should be

Figure 3.1 New Tree Planting Procedure

Source: *Urban Forest Forum*, April/May 1990, Vol. 10, No. 2, American Forestry Association. Extracted with permission of American Forestry Association.

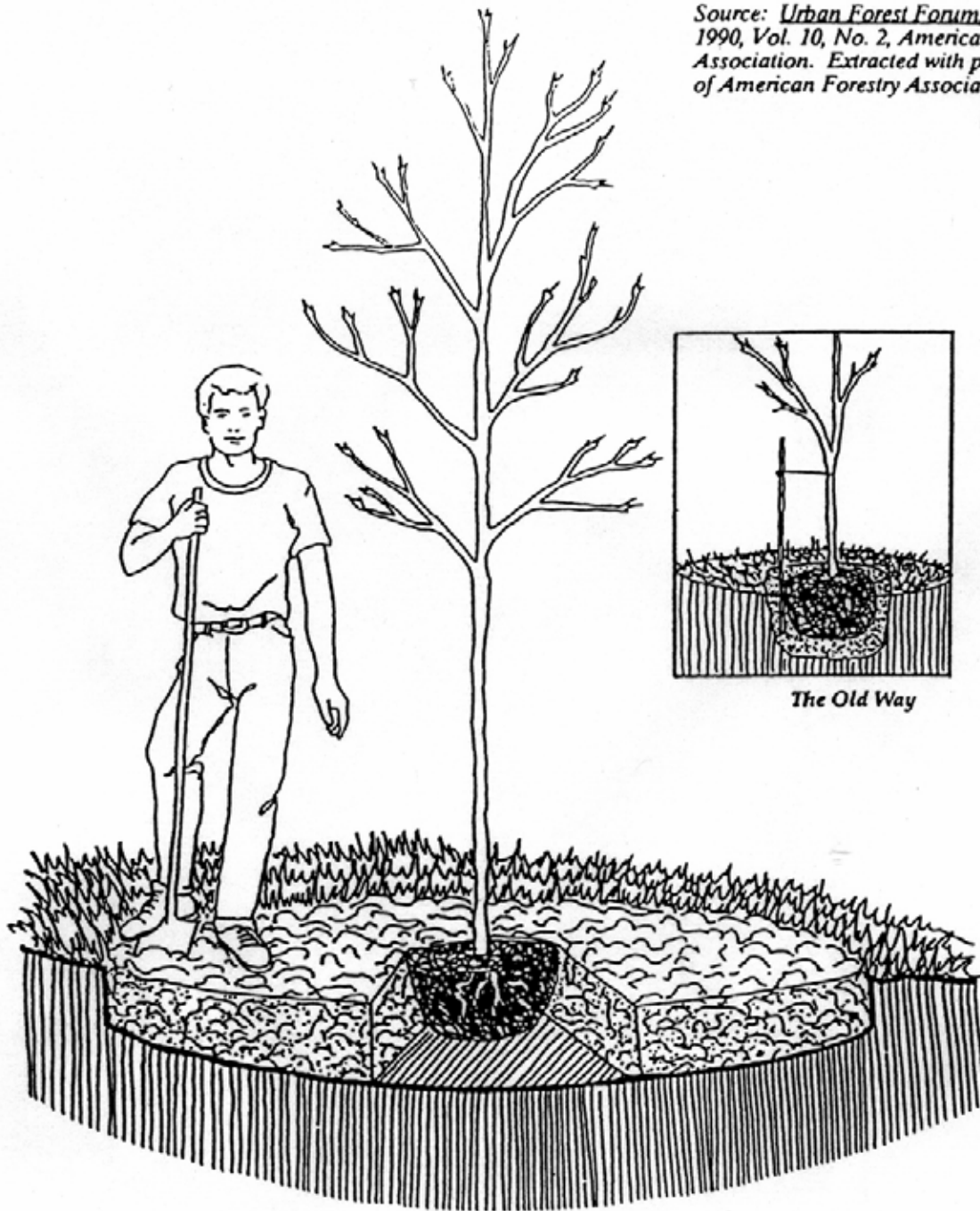

The Old Way

The new method of tree planting will result in better survival and growth than the old method. Grass competition and soil compaction are two of the most common factors in poor performance. The New Method: Prepare a planting area five times the diameter of the root ball or container. Use a rototiller and/or spades to loosen and mix the soil to a depth of about 12 inches. Organic matter (well decomposed) can be added. Dig a hole in the center to set the tree, so that the root ball will rest on solid ground. Backfill around the root area, pressing the soil but not packing it. Mulch the entire prepared area with 2 to 4 inches of bark, wood chips, decomposed sawdust, or leaves. Reference the article for a full explanation.

removed per nursery recommendations.

I. Mulching

Mulch the disturbed area around individual trees and shrubs with a 2-3" layer of wood chips. Pull wood chips 1 inch away from the base of shrubs to avoid fungus development.

J. Pruning

After planting, prune to remove injured twigs and branches. The natural shape of the plant should not be changed.

K. Cleanup and Maintenance

- 1) After all work is complete, all excess soil, peat moss, debris, etc., shall be removed from the site.
- 2) Water plants two weeks after planting. For two years, water plants every two weeks during dry periods, which exceed three weeks without a good soaking rain. Shrubs may require 5 to 10 gallons and trees, 20 to 30 gallons for each watering.
- 3) Remove trunk wrap one year after planting.

2. Transplanting "Wild" Stock

Successful transplanting of wild stock will require heavy equipment and considerable labor as a large weight of soil must be moved with the roots.

- A. Select trees and shrubs with good form and full crowns.
- B. Transplant only when plants are dormant and soil is moist. Wrap soil ball with burlap to prevent soil from separating from roots.
- C. Table 3.5 shows minimum diameter and approximate weight of soil ball that must be moved with each size plant.
- D. Plant and maintain as described above for nursery stock.

PRUNING AND THINNING

Use	Cleared Width Each Side of Trail Tread (ft.)	Cleared Height (ft.)
<u>TRAILS</u>		
Hiking	1	8
Bicycle	2	10
Motorbike	2	10
Horse	2	12
X-Country Ski	Total: 3 - 12	12 ¹
Snowmobile	Total: 6 - 12	12 ¹
<u>PICNIC & CAMPING AREAS</u>		
Campfire/Grill	10 ft. diam.	15+ Locations

1. Pruning

- A. Remove trees, limbs, and limb stubs to the following widths and heights specified for the intended use.
- ¹ Includes allowance for snow depth and snow load on branches.
- B. Remove dead, diseased, or dying limbs that may fall.
- C. Do not remove more than one-third of the live crown of a tree in a year.
- D. Cut limbs flush to the branch bark ridge.
- E. Use the 3 or 4 cut pruning method on all branches over 2 inches in diameter: First cut about one-third the way through the underside of the limb (about 6-12 inches from the tree trunk). Then (approximately an inch further out) make a second cut through the limb from the upper side. When the branch is removed, there is no splintering of the main tree trunk. Remove the stub. If the branch is larger than 5-6 inches in diameter, use the four cut system. Cuts 1 and 2 remain the same and cut 3 should be from the underside of the limb, on the outside of the branch collar. Cut 4 should be from the top and in alignment with the 3rd cut. Cut 3 should be 1/4 to 1/3 the way through the limb. This will prevent the bark from peeling down the trunk. Do not paint the cut surface.

2. Thinning

- A. Remove dead, diseased, dying, poorly anchored, or ice damaged trees that pose a hazard to recreationists or that interfere with intended use.
- B. To maintain grass cover in a wooded area, thin according to formula $D \times 3$ (average diameter of the trunk of overstory trees, in inches, times three—the answer is the spacing between trees to be left, in feet). For example, for trees with average diameter of 6 inches, spacing after thinning should leave trees 18 feet apart on average. Crown cover after thinning should be about 50 percent.
- C. Selectively thin as needed to favor those trees that are most "resistant" to compaction around their roots. See Table 3.4, "Susceptibility of Tree Species to Compaction." If the soil on the site is naturally well drained, those species in the "intermediate" group may also be favored.

PROTECTING TREES IN HEAVY USE AREAS

The compaction of soil over the roots of trees and shrubs by the trampling of recreationists, vehicular traffic, etc., reduces oxygen, water, and nutrient uptake by feeder roots. This weakens and may eventually kill the plants. Table 3.4 rates the "Susceptibility of Tree Species to Compaction."

Where heavy compaction is anticipated, apply and maintain a 3 to 4 inch layer of undecayed wood chips or 2 inches of No. 2 washed, crushed gravel.

Table 3.3

Trees Suitable for Landscape and Conservation Plantings in New York

TREE SIZE:

Large Sized Trees (75'+) - Trees that exceed this height at maturity.

Medium Sized Trees (35'-75') - Trees in this height range at maturity.

Small Sized Trees (15'-35') - Trees relatively low at maturity.

VAR; (x) = varieties of the species are available for various uses.

FOLIAGE:

E = evergreen

c = colorful in fall

l = lustrous; shiny

D = deciduous

d = dense

u = unusual leaves

f = fine textured

SITE TOLERANCE:

cold = hardy in zones 2 and 3 (northeastern mountains)

wet = tolerant of moderately well to somewhat poorly drained soils.

dry = tolerant of sandy, gravelly, excessively drained soils.

shade = will tolerate some shady sites.

sea = trees which may tolerate seaside conditions.

city = trees that withstand usual city conditions.

PEST:

F = usually free S = susceptible

FEATURES:

Habit = general shape of open grown plants.

Bo - broad open (wide)

Co - columnar

FEATURES: (cont'd)

Ho - horizontal branching

Na - narrow

Op - open

Ov - ovoid/oblong

Pe - pendulous

Py - pyramidal

Ro - round

S - spreading

Up - upright

Wo - wide/open

BRK; (x) = bark has interesting characteristics of color, texture or form.

FLR; (x) = flowers are colorful and interesting.

f = fragrant;

s = showy;

u = unusual shape.

FRU; (x) = fruits are interesting and/or edible.

LVS; (x) = leaves have attractive color and/or unusual shape.

USES:

WIND; (x) = suitable for windbreaks and screening.

SHD; (x) = suitable as lawn shade trees.

STRT; (x) = trees often selected for street planting.

WILD; F/c = trees offering food and cover to wildlife.

F = trees providing food from fruits.

W/c = trees offering winter cover.

BARR; (x) = trees which can be used as a barrier to some traffic.

ORN; (x) = trees whose main value is ornamental.

Table 3.3 (cont'd)

Trees Suitable for Landscape and Conservation Plantings in New York

A. LARGE SIZED TREES (75 ft.+)	SITE TOLERANCE					FEATURES			USES				
	HEIGHT	VAR	FOLIAGE	COLD WET	DRY SHADE	SEA CITY	PEST	HABIT BRK	FLR FRU	LVS	WIND SHDE	STRT	WILDBARRORN
1. DECIDUOUS SPECIES													
BEECH, EUROPEAN <i>Fagus sylvatica</i>	90'	X	D,c,d,l					Py	X	X		X	
BIRCH, PAPER <i>Betula papyrifera</i>	90'		D,c	X				Py	X	X			X
BIRCH, RIVER <i>Betula nigra</i>	90'		D,c		X			Py	X	X			
CHERRY, BLACK <i>Prunus serotina</i>	90'	X	D,d,l	X		X		S	X	X		F	X
GINKGO <i>Ginkgo biloba</i>	120'		D,c,u			X	F	Wc		X		X	
GUM, BLACK TUPELO <i>Nyssa sylvatica</i>	90'		D,c,d,l	X		X		Py		X			X
HICKORY, PIGNUT <i>Carya glabra</i>	120'		D,c		X			Ro		X		F	X
HICKORY, SHAGBARK <i>Carya ovata</i>	120'	X	D,c					Na/Up	X	X		F	X
HONEYLOCUST 1 <i>Gleditsia</i> spp.	135'	X	D,c,u		X		X	F	Bo			X	X
JAPANESE ZELKOVA <i>Zelkova serrata</i>	90'		D,c					Ro		X		X	
KATSURA TREE <i>Cercidiphyllum japonicum</i>	60-100'		D,c,u					F	Ro			X	
LINDEN, LITTLE-LEAF <i>Tilia cordata</i>	90'	X	D,d	X		X		Py		X	X	X	
LONDON PLANE TREE <i>X Pteris acerifolia</i>	100'		D					S	X			X	
MAPLE, RED <i>Acer rubrum</i>	120'	X	D,c	X	X			Ro	X	X		X	
MAPLE, SUGAR <i>Acer saccharum</i>	120'	X	D,c	X				Ov		X		X	
OAK, WHITE <i>Quercus alba</i>	90'		D,c					Ro/S		X		F	X
POPLAR, HYBRID 2 <i>X Populus</i>	90'	X	D					varies				X	
POPLAR, WHITE <i>Populus alba</i>	90'	X	D,c,u	X	X			S		X			X
SWEET-GUM <i>Liquidambar styraciflua</i>	125'	X	D,c,u	X				F	Py			X	X

Table 3.3 (cont'd)

Trees Suitable for Landscape and Conservation Plantings in New York

A. LARGE SIZED TREES (75 ft.+)	SITE TOLERANCE										FEATURES			USES				
	HEIGHT	VAR FOLIAGE	COLD	WET	DRY	SHADE	SEA	CITY	PEST	HABIT	BRK	FLR	FRU	LVS	WIND	SHDE	STRT	WILDBARRORN
2. EVERGREEN SPECIES																		
CEDAR, EASTERN RED <i>Juniperus virginiana</i>	90'	X	E,d	X	X		X		F	Py	X	X		X				WC
FIR, DOUGLAS <i>Pseudotsuga menziesii</i>	300'	X	E,d							Py	X	X		X				WC
FIR, WHITE <i>Abies concolor</i>	120'	X	E,c							Py			X	X				WC
HEMLOCK, CANADA <i>Tsuga canadensis</i>	90'	X	E,d	X						Py				X				WC
LARCH, EUROPEAN <i>Larix decidua</i>	100'	X	D,c	X						Py		X						X
PINE, AUSTRIAN <i>Pinus nigra</i>	90'	X	E				X			Py				X				WC
PINE, EASTERN WHITE <i>Pinus strobus</i>	100-150'	X	E	X						Rot/Py				X				WC
PINE, JAPANESE BLACK <i>Pinus thunbergii</i>	90'		E				X			S								WC
SPRUCE, COLORADO <i>Picea pungens</i>	100'	X	E,c,d	X			X		S	Py			X	X				WC
SPRUCE, NORWAY <i>Picea abies</i>	150'	X	E,d	X						Py	X			X				WC
SPRUCE, SERBIAN <i>Picea omorika</i>	90'		E,c,d							Py				X				WC
SPRUCE, WHITE <i>Picea glauca</i>	90'	X	E	X						Py			X	X				WC

¹ Thornless, seedless cultivars recommended

² Select male, non-root suckering, disease resistant cultivars

Note: It is not recommended to combine Colorado Blue Spruce or any other spruce with Douglas Fir in the same landscape design. Douglas Fir is an alternate host for the Cooley Spruce Gall Aphid.

Table 3.3 (cont'd)

Trees Suitable for Landscape and Conservation Plantings in New York

B. MEDIUM SIZED TREES (35'-75')	SITE TOLERANCE										FEATURES				USES		
	1. DECIDUOUS SPECIES	HEIGHT	VAR FOLIAGE	COLD WET	DRY SHADE	SEA CITY	PEST	HABIT BRK	FLR FRU	LVS	WIND SHDE	STRT	WILD BARR	ORN			
ALDER, EUROPEAN <i>Alnus glutinosa</i>	75'	D	X	X				Ov			X						
ALDERS <i>Alnus spp.</i>	60'-75'	D,d	X	X		S		Ro	X		X						
ASH, FLOWERING <i>Fraxinus ornus</i>	60'	D,d						Ro	X,f		X		X				
ASH, GREEN <i>Fraxinus pennsylvanica</i>	60'	D,c,d	X					Ro		X	X						
BIRCH, SWEET <i>Betula lenta</i>	75'	D,c	X					Py	X	X	X		X				
CHERRY, EUROPEAN BIRD <i>Prunus pectus</i>	45'	D,u	X					Op	X,f	X		F					
CHERRY, PIN 1 <i>Prunus pennsylvanica</i>	36'	D,c,f	X		X			Op	X	X	X	F	X				
CHERRY, SARGENT <i>Prunus sargentii</i>	75'	D,c,d	X					Up	X	X	X	F	X				
CHESTNUT, CHINESE <i>Castanea mollissima</i>	60'	D,c,d,l						Ro			X	F					
CHOCHECHERRY, AMUR <i>Prunus maackii</i>	45'	D,d	X					Ro	X	X		F	X				
CRAB APPLE, SIBERIAN <i>Malus baccata</i>	50'	D,d	X			S		Na	X,f	X		F	X				
CRIMEAN LINDEN <i>X Tilia euchlora</i>	60'	D,d,l						Pe	X,f		X						
DOGWOOD, FLOWERING <i>Cornus florida</i>	40'	D,c,d,l	X			F		Ho	X	X,u	X	X	X				
ELM, SIBERIAN <i>Ulmus pumila</i>	75'	D,f		X				Ro/OpF				X					
HAWTHORN, COCKSPUR <i>Crataegus crnus-galli</i>	36'	D,d,l	X		X		S	Ro/S	X	X	X	F	X				
HOLLY, AMERICAN <i>Ilex opaca</i>	45'	E,d,u				X		Py	X	X	X	WC	X				
HORNBEAM, AMERICAN <i>Carpinus caroliniana</i>	36'	D,c,d	X				F	Ro	X	X	X	F					
HORNBEAM, EUROPEAN <i>Carpinus betulus</i>	60'	D,d	X					Py			X		X				
HORNBEAM, HOP <i>Ostrya virginiana</i>	60'	D,d				F		Py	X	X	X	F	X				

Table 3.3 (cont'd)

Trees Suitable for Landscape and Conservation Plantings in New York

B. MEDIUM SIZED TREES (35'-75')	SITE TOLERANCE					FEATURES					USES		
	HEIGHT	VAR FOLIAGE	COLD WET	DRY SHADE	SEA CITY PEST	HABIT BRK	FLR FRU	LVS	WIND SHDE	STRT	WILDBARRORN		
1. DECIDUOUS SPECIES													
JAPANESE PAGODA TREE <i>Sophora japonica</i>	75'	X D		X	F	Ro	X	X		X	X		X
LOCUST, BLACK ² <i>Robinia pseudoacacia</i>	75'	X D	X	X		Ov		X					
MAPLE, STRIPED <i>Acer pensylvanicum</i>	36'	X D,u	X			Op	X						X
MOUNTAIN-ASH, EUROPEAN <i>Sorbus aucuparia</i>	45'	X D			S	S	X	X				F	X
MOUNTAIN-ASH, KOREAN <i>Sorbus alnifolia</i>	60'	X D,d				Py/Ro	X	X	X				X
MULBERRY, WHITE <i>Morus alba</i>	45'	X D,d,u		X		Ro		X				F	
OAK, RED <i>Quercus borealis</i>	75'	D,d,l	X		X	Ro		X	X	X	X	F	
OAK, SWAMP WHITE <i>Quercus bicolor</i>	60'	D,d	X	X		Na/Ro				X		F	
OAK, WILLOW <i>Quercus phellos</i>	50'	D,f				Ro					X		X
POPLAR, SIMON <i>Populus simonii</i>	50'	X D,d	X			Na				X			X
REDBUD, EASTERN <i>Cercis canadensis</i>	36'	X D,c,u				Wo		X					X
SASSAFRAS <i>Sassafras albidum</i>	60'	D,u				So	X	X	X				X
SERVICEBERRY <i>Amelanchier</i> spp.	25'-60'	D,c		X	S	S	X	X	X			F	X
SORREL TREE <i>Oxydendrum arboreum</i>	75'	D,c,d,l				Py		X	X				X
WILLOW, THURLOW WEeping <i>X Salix elegantissima</i>	40'	D,f	X		S	Pe							X
WILLOW, WHITE <i>Salix alba</i>	75'	X D	X	X		Up				Colored winter twigs			X
YELLOW-WOOD, AMERICAN <i>Cladrasis lutea</i>	50'	X D,c,d	X			Ro	X	X					X

¹ Spreads rapidly by root suckers

² Spreads rapidly by root suckers, do not plant near Pine Barrens ecosystems

Table 3.3 (cont'd)
Trees Suitable for Landscape and Conservation Plantings in New York

B. MEDIUM SIZED TREES (35'-75')	SITE TOLERANCE										FEATURES			USES						
	HEIGHT	VAR FOLIAGE	COLD	WET	DRY	SHADE	SEA	CITY	PEST	HABIT	BRK	FLR	FRU	LVS	WIND	SHDE	STR	WILD	BARR	ORN
2. EVERGREEN SPECIES																				
ARBORVITAE, AMERICAN <i>Thuja occidentalis</i>	60'	X	E,u	X	X	X	X	X		Co					X			WC		X
FIR, KOREAN <i>Abies koreana</i>	50'		E,d							Py				X				WC		X
FIR, VEITCH <i>Abies veitchii</i>	75'		E,c	X						Py				X				WC		
HEMLOCK, CAROLINA <i>Tsuga caroliniana</i>	75'		E,d					X		Py/Pe				X	X			WC		X
PINE, JACK <i>Pinus banksiana</i>	75'		E	X			X			Bo								WC		
PINE, PITCH <i>Pinus rigida</i>	75'		E				X			Op								WC		
PINE, RED <i>Pinus resinosa</i>	75'		E	X			X			Py					X			WC		
PINE, SCOTCH <i>Pinus sylvestris</i>	75'	X	E	X				X		Op/Py	X				X			WC		
PINE, SWISS STONE <i>Pinus cembra</i>	75'		E,d	X						Py/S								WC		X
SPRUCE, BLACK	50'		E,d	X	X		X			Co					X			WC		
SPRUCE, BLACK HILLS	75'		E,d	X			X		F	Co					X			WC		

Table 3.3 (cont'd)

Trees Suitable for Landscape and Conservation Plantings in New York

C. SMALL SIZED TREES (15'-35')	SITE TOLERANCE					FEATURES				USES							
	HEIGHT	VAR	FOLIAGE	COLD WET	DRY SHADE	SEA	CITY	PEST	HABIT	BRK	FLR	FRU	LVS	WIND SHDE	STRT	WILD BARR	ORN
BIRCH, GRAY <i>Betula populifolia</i>	30'		D	X	X			S	several stems	X			X				X
BLACKHAW <i>Viburnum prunifolium</i>	30'		D,c,1	X						X	X	X	X		F	X	
CHERRY, CORNELIAN <i>Cornus mas</i>	24'	X	D,1					F	Ro	X	X	X			F		
CHERRY, SOUR <i>Prunus cerasus</i>	30'	X	D	X					Ro	X	X				F		X
CORK TREE, AMUR <i>Phellodendron amurense</i>	30'		D	X					Wo	X	X	X					
CRABAPPLES <i>Malus spp</i>	15'-30'		D	X				S	Ro	X,s	X			X	F	X	
DOGWOOD, JAPANESE <i>Cornus kousa</i>	20'	X	D,d,1						Ho	X,s	X	X					X
HAWTHORNS <i>Crataegus spp</i>	15'-30'	X	D,d	X				S	Rathorny	X	X	X		X	F	X	
LABURNUM SCOTCH <i>Laburnum alpinum</i>	30'	X	D						U	X,u			X				
LILAC, JAPANESE TREE <i>Syringa amurensis japonica</i>	30'		D,coarse							X	X,u		X				X
MAPLE, AMUR <i>Acer glinnala</i>	20'	X	D,c,d	X				X	Up/Ro	X,f	X	X	X				X
MAPLE, MOUNTAIN <i>Acer spicatum</i>	25'		D,coarse	X					Ov		X	X					X
MOUNTAIN-ASH, SHOWY <i>Sorbus decora</i>	30'	X	D	X				S	shrubby	X	X						X
NANNYBERRY <i>Viburnum lentago</i>	30'		D,c,1	X					dense/shrubby	X	X	X	X		F		X
RHODODENDRON, ROSEBAY <i>Rhododendron maximum</i>	12'-36'	X	E	X					Ro		X						X
SEA-BUCKTHORN, COMMON <i>Hippophae rhamnoides</i>	30'			X				X	Ro/o	X	X	X	X				X

Table 3.4
Susceptibility of Tree Species to Compaction¹

Resistant:

Box elder.....	<i>Acer negundo</i>	Willows.....	<i>Salix spp.</i>
Green ash.....	<i>Fraxinus pennsylvanica</i>	Honey locust.....	<i>Gleditsia triacanthos</i>
Red elm.....	<i>Ulmus rubra</i>	Eastern cottonwood.....	<i>Populus deltoides</i>
Hawthornes.....	<i>Crataegus spp.</i>	Swamp white oak.....	<i>Quercus bicolor</i>
Bur oak.....	<i>Quercus macrocarpa</i>	Hophornbeam.....	<i>Ostrya virginiana</i>
Northern white cedar....	<i>Thuja occidentalis</i>		

Intermediate:

Red maple.....	<i>Acer rubrum</i>	Sweetgum.....	<i>Liquidambar styraciflua</i>
Silver maple.....	<i>Acer saccharinum</i>	Norway maple.....	<i>Acer platanoides</i>
Hackberry.....	<i>Celtis occidentalis</i>	Shagbark hickory.....	<i>Carya ovata</i>
Black gum.....	<i>Nyssa sylvatica</i>	London plane.....	<i>Platanus x hybrida</i>
Red oak.....	<i>Quercus rubra</i>	Pin oak.....	<i>Quercus palustris</i>
Basswood.....	<i>Tilia americana</i>		

Susceptible:

Sugar maple.....	<i>Acer saccharum</i>	Austrian Pine.....	<i>Pinus nigra</i>
White pine.....	<i>Pinus strobus</i>	White ash.....	<i>Fraxinus americana</i>
Blue spruce.....	<i>Picea pungens</i>	Paper birch.....	<i>Betula papyrifera</i>
White oak.....	<i>Quercus alba</i>	Moutain ash.....	<i>Sorbus aucuparia</i>
Red pine.....	<i>Pinus resinosa</i>	Japanese maple.....	<i>Acer palmatum</i>

¹ If a tree species does not appear on the list, insufficient information is available to rate it for this purpose.

Table 3.5
Size and Weight of Earth Ball Required to Transplant Wild Stock

Caliper ¹ (Inches)	Shade Trees (Maple, Ash, Oak, Birch, etc.)		Small Trees & Shrubs (Crabapple, Thornapple, Viburnum, Dogwood, etc.)		
	Minimum Diameter Ball (Inches)	Weight of Ball (lbs.)	Up to 6 ft. Height — 6 ft. and Caliper ¹	Minimum Diameter Ball (Inches)	Weight of Ball (lbs.)
1/2	14	88	2	12	55
3/4	16	130	3	14	88
1	18	186	4	16	130
1-1/4	20	227	5	18	186
1-1/2	22	302	3/4	18	186
1-3/4	24	390	1	20	227
2	28	621	1-1/2	22	302
3	32	836	1-3/4	24	390
3-1/2	38	1,400	2	28	621
4	42	1,887	2-1/2	32	836
			3	38	1,400

¹Caliper is a diameter measurement of trees at a height of 6 inches above the ground.
(American Standards for Nursery Stock)

STANDARD AND SPECIFICATIONS FOR VEGETATING WATERWAYS



Definition

Waterways are a natural or constructed outlet, shaped or graded. They are vegetated as needed for safe transport of runoff water.

Purpose

To provide for the safe transport of excess surface water from construction sites and urban areas without damage from erosion.

Conditions Where Practice Applies

This standard applies to vegetating waterways and similar water carrying structures.

Supplemental measures may be required with this practice. These may include: subsurface drainage to permit the growth of suitable vegetation and to eliminate wet spots; a section stabilized with asphalt, stone, or other suitable means; or additional storm drains to handle snowmelt or storm runoff.

Retardance factors for determining waterway dimensions are shown in Table 5B.1 and "Maximum Permissible Velocities for Selected Grass and Legume Mixtures," are shown in Table 3.6.

Design Criteria

Waterways or outlets shall be protected against erosion by vegetative means as soon after construction as practical. Vegetation must be well established before diversions or other channels are outletted into them. Consideration should be given to the use of synthetic products, jute or excelsior matting, other rolled erosion control products, or sodding of channels to provide erosion protection as soon after construction as possible. It is strongly recommended that the center line of the waterway be protected with one of the above materials to avoid center gullies.

1. Liming, fertilizing, and seedbed preparation.
 - A. Lime to pH 6.5.
 - B. **The soil should be tested to determine the amounts of amendments needed.** If the soil must be fertilized before results of a soil test can be obtained to determine fertilizer needs, apply commercial fertilizer at 1.0 lbs/1,000 sq. ft. of N, P₂O₅, and K₂O.
 - C. Lime and fertilizer shall be mixed thoroughly into the seedbed during preparation.
 - D. Channels, except for paved section, shall have at least 4 inches of topsoil.
 - E. Remove stones and other obstructions that will hinder maintenance.
2. Timing of Seeding.
 - A. Early spring and late August are best.
 - B. Temporary cover to protect from erosion is recommended during periods when seedings may fail.
3. Seed Mixtures:

<u>Mixtures</u>	<u>Rate per Acre (lbs)</u>	<u>Rate per 1,000 sq. ft. (lbs)</u>
A. Birdsfoot trefoil or ladino clover ¹	8	0.20
Tall fescue or smooth bromegrass	20	0.45
Redtop ²	2	0.05
	30	0.70
OR		
B. Kentucky bluegrass ³	25	0.60
Creeping red fescue	20	0.50
Perennial ryegrass	10	0.20
	55	1.30

¹ Inoculate with appropriate inoculum immediately prior to seeding. Ladino or common white clover may be substituted for birdsfoot trefoil and seeded at the same rate.

² Perennial ryegrass may be substituted for the redtop but increase seeding rate to 5 lbs/acre (0.1 lb/1,000 sq. ft.).

³ Use this mixture in areas which are mowed frequently. Common white clover may be added if desired and seeded at 8 lbs/acre (0.2 lb/1,000 sq. ft.).

4. Seeding

Select the appropriate seed mixture and apply uniformly over the area. Rolling or cultipacking across the waterway is desirable.

Waterway centers or crucial areas may be sodded. Refer to the standard and specification for Stabilization with Sod. Be sure sod is securely anchored using staples or stakes.

5. Mulching.

All seeded areas will be mulched. Channels more than 300 feet long, and/or where the slope is 5 percent or more, must have the mulch securely anchored. Refer to the standard and specifications for Mulching for details.

6. Maintenance

Fertilize, lime, and mow as needed to maintain dense protective vegetative cover.

Waterways shall not be used for roadways.

If rills develop in the centerline of a waterway, prompt attention is required to avoid the formation of gullies. Either stone and/or compacted soil fill with excelsior or filter fabric as necessary may be used during the establishment phase. See Figure 3.2, Rill Maintenance Measures. Spacing between rill maintenance barriers shall not exceed 100 feet.

Table 3.6
Maximum Permissible Velocities for Selected Seed Mixtures

Cover	Slope Range ² (%)	Permissible Velocity ¹	
		Erosion-resistant Soils (ft. per sec.) K=0.10 - 0.35 ³	Easily Eroded Soils (ft. per sec.) K=0.36 - 0.80
Kentucky Bluegrass	0-5	7	5
Smooth Brome	5-10	6	4
Tall Fescue	Over 10	5	3
Grass Mixtures	² 0-5	5	4
Reed Canarygrass	5-10	4	3
Redtop Alfalfa Red Fescue	⁴ 0-5	3.5	2.5

¹ Use velocities exceeding 5 feet per second only where good covers and proper maintenance can be obtained.

² Do not use on slopes steeper than 10 percent except for vegetated side slopes in combination with a stone, concrete, or highly resistant vegetative center section.

³ K is the soil erodibility factor used in the Revised Universal Soil Loss Equation. Visit Appendix A or consult the appropriate USDA-NRCS technical guide for K values for New York State soils.

⁴ Do not use on slopes steeper than 5 percent except for vegetated side slopes in combination with a stone, concrete, or highly resistant vegetative center section.

⁵ Annuals - use on mild slopes or as temporary protection until permanent covers are established.

⁶ Use on slopes steeper than 5 percent is not recommended.

Figure 3.2
Rill Maintenance Measures

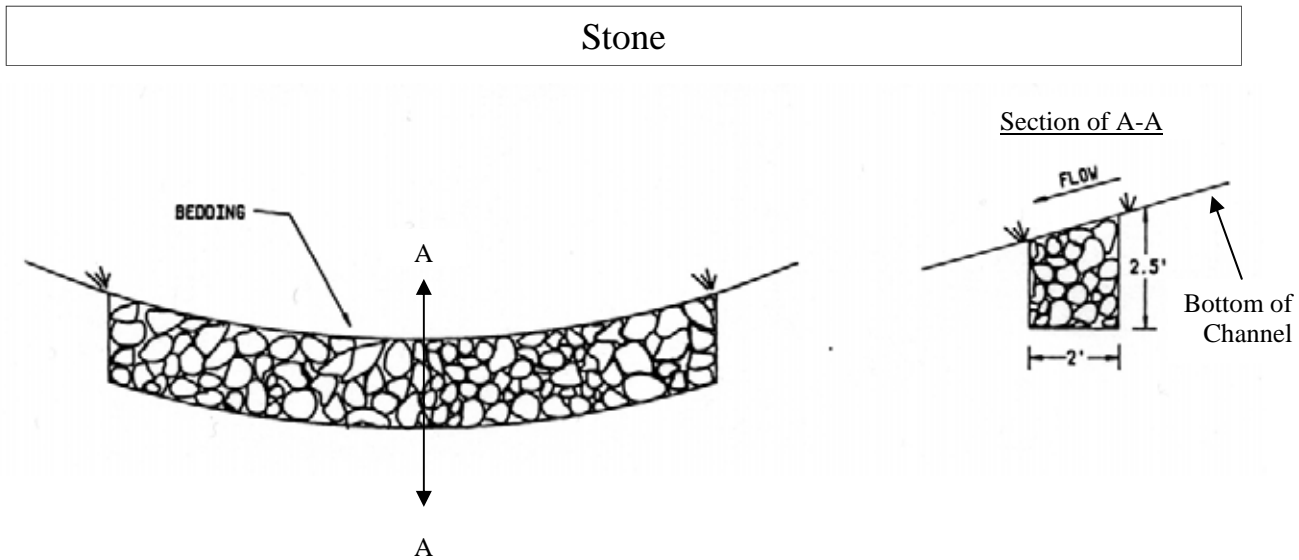
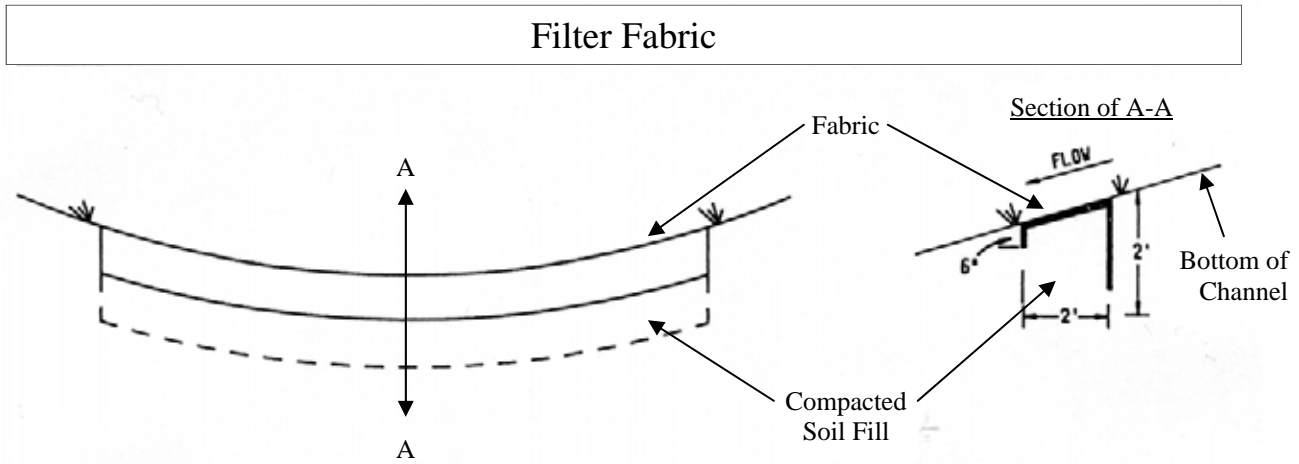

STANDARD AND SPECIFICATIONS FOR TOPSOILING



Definition

Spreading a specified quality and quantity of topsoil materials on graded or constructed subsoil areas.

Purpose

To provide acceptable plant cover growing conditions, thereby reducing erosion; to reduce irrigation water needs; and to reduce the need for nitrogen fertilizer application.

Conditions Where Practice Applies

Topsoil is applied to subsoils that are droughty (low available moisture for plants), stony, slowly permeable, salty or extremely acid. It is also used to backfill around shrub and tree transplants. This standard does not apply to wetland soils.

Design Criteria

1. Preserve existing topsoil in place where possible, thereby reducing the need for added topsoil.
2. Conserve by stockpiling topsoil and friable fine textured subsoils that must be stripped from the excavated site and applied after final grading where vegetation will be established.
3. Refer to USDA Soil Conservation Service (presently Natural Resource Conservation Service) soil surveys or soil interpretation record sheets for further soil texture information for selecting appropriate design topsoil depths.

Site Preparation

1. As needed, install erosion control practices such as diversions, channels, sediment traps, and stabilizing measures, or maintain if already installed.
2. Complete rough grading and final grade, allowing for depth of topsoil to be added.
3. Scarify all compact, slowly permeable, medium and fine textured subsoil areas. Scarify at approximately right angles to the slope direction in soil areas that are steeper than 5 percent. Areas that have been overly compacted shall be decompact to a minimum depth of 12 inches with a deep ripper or chisel plow prior to topsoiling.
4. Remove refuse, woody plant parts, stones over 3 inches in diameter, and other litter.

Topsoil Materials

1. Topsoil shall have at least 6 percent by weight of fine textured stable organic material, and no greater than 20 percent. Muck soil shall not be considered topsoil.
2. Topsoil shall have not less than 20 percent fine textured material (passing the NO. 200 sieve) and not more than 15 percent clay.
3. Topsoil treated with soil sterilants or herbicides shall be so identified to the purchaser.
4. Topsoil shall be relatively free of stones over 1 1/2 inches in diameter, trash, noxious weeds such as nut sedge and quackgrass, and will have less than 10 percent gravel.
5. Topsoil containing soluble salts greater than 500 parts per million shall not be used.

Application and Grading

1. Topsoil shall be distributed to a uniform depth over the area. It shall not be placed when it is partly frozen, muddy, or on frozen slopes or over ice, snow, or standing water puddles.
2. Topsoil placed and graded on slopes steeper than 5 percent shall be promptly fertilized, seeded, mulched, and stabilized by "tracking" with suitable equipment.

3. Apply topsoil in the following amounts:

Site Conditions	Intended Use	Minimum Topsoil Depth
1. Deep sand or loamy sand	Mowed lawn	6 in.
	Tall legumes, unmowed	2 in.
	Tall grass, unmowed	1 in.
2. Deep sandy loam	Mowed lawn	5 in.
	Tall legumes, unmowed	2 in.
	Tall grass, unmowed	none
3. Six inches or more: silt loam, loam, or silt	Mowed lawn	4 in.
	Tall legumes, unmowed	1 in.
	Tall grass, unmowed	1 in.

STANDARD AND SPECIFICATIONS FOR MULCHING



Definition

Applying coarse plant residue or chips, or other suitable materials, to cover the soil surface.

Purpose

The primary purpose is to provide initial erosion control while a seeding or shrub planting is establishing. Mulch will conserve moisture and modify the surface soil temperature and reduce fluctuation of both. Mulch will prevent soil surface crusting and aid in weed control. Mulch is also used alone for temporary stabilization in non-growing months.

Conditions Where Practice Applies

On soils subject to erosion and on new seedlings and shrub plantings. Mulch is useful on soils with low infiltration rates by retarding runoff.

Criteria

Site preparation prior to mulching requires the installation of necessary erosion control or water management practices and drainage systems.

Slope, grade and smooth the site to fit needs of selected mulch products.

Remove all undesirable stones and other debris to meet the needs of the anticipated land use and maintenance required.

Apply mulch after soil amendments and planting is accomplished or simultaneously if hydroseeding is used.

Select appropriate mulch material and application rate or material needs. Determine local availability.

Select appropriate mulch anchoring material.

NOTE: The best combination for grass/legume establishment is straw (cereal grain) mulch applied at 2 ton/acre (90 lbs./1000sq.ft.) and anchored with wood fiber mulch (hydromulch) at 500 – 750 lbs./acre (11 – 17 lbs./1000 sq. ft.). The wood fiber mulch must be applied through a hydroseeder immediately after mulching.

Table 3.7
Guide to Mulch Materials, Rates, and Uses

Mulch Material	Quality Standards	per 1000 Sq. Ft.	per Acre	Depth of Application	Remarks
Wood chips or shavings	Air-dried. Free of objectionable coarse material	500-900 lbs.	10-20 tons	2-7"	Used primarily around shrub and tree plantings and recreation trails to inhibit weed competition. Resistant to wind blowing. Decomposes slowly.
Wood fiber cellulose (partly digested wood fibers)	Made from natural wood usually with green dye and dispersing agent	50 lbs.	2,000 lbs.	—	Apply with hydromulcher. No tie down required. Less erosion control provided than 2 tons of hay or straw.
Gravel, Crushed Stone or Slag	Washed; Size 2B or 3A—1 1/2"	9 cu. yds.	405 cu. yds.	3"	Excellent mulch for short slopes and around plants and ornamentals. Use 2B where subject to traffic. (Approximately 2,000 lbs./cu. yd.). Frequently used over filter fabric for better weed control.
Hay or Straw	Air-dried; free of undesirable seeds & coarse materials	90-100 lbs. 2-3 bales	2 tons (100-120 bales)	cover about 90% surface	Use small grain straw where mulch is maintained for more than three months. Subject to wind blowing unless anchored. Most commonly used mulching material. Provides the best micro-environment for germinating seeds.
Jute twisted yarn	Undyed, unbleached plain weave. Warp 78 ends/yd., Weft 41 ends/yd. 60-90 lbs./roll	48" x 50 yds. or 48" x 75 yds.	—	—	Use without additional mulch. Tie down as per manufacturers specifications. Good for center line of concentrated water flow.
Excelsior wood fiber mats	Interlocking web of excelsior fibers with photodegradable plastic netting	8" x 100" 2-sided plastic, 48" x 180" 1-sided plastic	—	—	Use without additional mulch. Excellent for seeding establishment. Tie down as per manufacturers specifications. Approximately 72 lbs./roll for excelsior with plastic on both sides. Use two sided plastic for centerline of waterways.
Compost	Up to 3" pieces, moderately to highly stable	3-9 cu. yds.	134-402 cu. yds.	1-3"	Coarser textured mulches may be more effective in reducing weed growth and wind erosion.
Straw or coconut fiber, or combination	Photodegradable plastic net on one or two sides	Most are 6.5 ft. x 3.5 ft.	81 rolls	—	Designed to tolerate higher velocity water flow, centerlines of waterways, 60 sq. yds. per roll.

Table 3.8
Mulch Anchoring Guide

Anchoring Method or Material	Kind of Mulch to be Anchored	How to Apply
1. Peg and Twine	Hay or straw	After mulching, divide areas into blocks approximately 1 sq. yd. in size. Drive 4-6 pegs per block to within 2" to 3" of soil surface. Secure mulch to surface by stretching twine between pegs in criss-cross pattern on each block. Secure twine around each peg with 2 or more tight turns. Drive pegs flush with soil. Driving stakes into ground tightens the twine.
2. Mulch netting	Hay or straw	Staple the light-weight paper, jute, wood fiber, or plastic nettings to soil surface according to manufacturer's recommendations. Should be biodegradable. Most products are not suitable for foot traffic.
3. Wood cellulose fiber	Hay or straw	Apply with hydroseeder immediately after mulching. Use 500 lbs. wood fiber per acre. Some products contain an adhesive material ("tackifier"), possibly advantageous.
4. Mulch anchoring tool	Hay or straw	Apply mulch and pull a mulch anchoring tool (blunt, straight discs) over mulch as near to the contour as possible. Mulch material should be "tucked" into soil surface about 3".
5. Tackifier	Hay or straw	Mix and apply polymeric and gum tackifiers according to manufacturer's instructions. Avoid application during rain. A 24-hour curing period and a soil temperature higher than 45 ⁰ Fahrenheit are required.

STANDARD AND SPECIFICATIONS FOR STABILIZATION WITH SOD



Definition

Stabilizing silt producing areas by establishing long term stands of grass with sod.

Purpose

To stabilize the soil; reduce damage from sediment and runoff to downstream areas; enhance natural beauty.

Conditions Where Practice Applies

On exposed soils that have a potential for causing off site environmental damage where a quick vegetative cover is desired. Moisture, either applied or natural, is essential to success.

Design Criteria

1. Sod shall be bluegrass or a bluegrass/red fescue mixture or a perennial ryegrass for average sites. (CAUTION: Perennial ryegrass has limited cold tolerance and may winter kill.) Use turf type cultivars of tall fescue for shady, droughty, or otherwise more critical areas. For variety selection, contact Cornell Cooperative Extension Turf Specialist.
2. Sod shall be machine cut at a uniform soil thickness of 3/4 inch, plus or minus 1/4 inch. Measurement for thickness shall exclude top growth and thatch.
3. Standard size sections of sod shall be strong enough to support their own weight and retain their size and shape when suspended vertically from a firm grasp on the upper 10 percent of the section.
4. Sod shall be free of weeds and undesirable coarse weedy grasses. Wild native or pasture grass sod shall not be used

unless specified.

5. Sod shall not be harvested or transplanted when moisture content (excessively dry or wet) may adversely affect its survival.
6. Sod shall be harvested, delivered, and installed within a period of 36 hours. Sod not transplanted within this period shall be inspected and approved by the contracting officer or his designated representative prior to its installation.

Site Preparation

Fertilizer and lime application rates shall be determined by soil tests. Under unusual circumstances where there is insufficient time for a complete soil test and the contracting officer agrees, fertilizer and lime materials may be applied in amounts shown in subsection 2 below. Slope land such as to provide good surface water drainage. Avoid depressions or pockets.

1. Prior to sodding, the surface shall be smoothed and cleared of all trash, debris, and of all roots, brush, wire, grade stakes and other objects that would interfere with planting, fertilizing or maintenance operations.
2. **The soil should be tested to determine the amounts of amendments needed.** Where the soil is acid or composed of heavy clays, ground limestone shall be spread to raise the pH to 6.5. If the soil must be fertilized before results of a soil test can be obtained to determine fertilizer needs, apply commercial fertilizer at 20 lbs. of 5-10-10 (or equivalent) and mix into the top 3 inches of soil with the required lime for every 1,000 square feet. Soil should be moist prior to sodding. Arrange for temporary storage of sod to keep it shaded and cool.

Sod Installation

1. For the operation of laying, tamping, and irrigating for any areas, sod shall be completed within eight hours. During periods of excessively high temperature, the soil shall be lightly moistened immediately prior to laying the sod.
2. The first row of sod shall be laid in a straight line with subsequent rows placed parallel to, and tightly wedged against, each other. Lateral joints shall be staggered to promote more uniform growth and strength. Ensure that sod is not stretched or overlapped and that all joints are butted tight in order to prevent voids which would cause air drying of the roots. On sloping areas where erosion may be a problem, sod shall be laid with the long edges parallel to the contour and with staggered joints.

3. Secure the sod by tamping and pegging, or other approved methods. As sodding is completed in any one section, the entire area shall be rolled or tamped to ensure solid contact of roots with the soil surface.

4. Sod shall be watered immediately after rolling or tamping until the underside of the new sod pad and soil surface below the sod are thoroughly wet. Keep sod moist for at least two weeks.

Sod Maintenance

1. In the absence of adequate rainfall, watering shall be performed daily, or as often as deemed necessary by the inspector, during the first week and in sufficient quantities to maintain moist soil to a depth of 4 inches. Watering should be done in the morning. Avoid excessive watering during applications.

2. After the first week, sod shall be watered as necessary to maintain adequate moisture and ensure establishment.

3. The first mowing should not be attempted until sod is firmly rooted. No more than 1/3 of the grass leaf shall be removed by the initial cutting or subsequent cuttings. Grass height shall be maintained between 2 and 3 inches unless

otherwise specified. Avoid heavy mowing equipment for several weeks to prevent rutting.

4. If the soil must be fertilized before results of a soil test can be obtained to determine fertilizer needs, apply fertilizer three to four weeks after sodding, at a rate of 1 pound nitrogen/1,000 sq.ft. Use a complete fertilizer with a 2-1-1 ratio.

5. Weed Control: Target herbicides for weeds present. Consult current Cornell Pest Control Recommendations for Commercial Turfgrass Management or consult the local office of Cornell Cooperative Extension.

6. Disease Control: Consult the local office of the Cornell Cooperative Extension.

Additional References

1. Home Lawns, Establishment and Maintenance, CCE Information Bulletin 185, Revised November 1994. Cornell University, Ithaca, NY.

2. Installing a Sod Lawn. CCE Suffolk County, NY. Thomas Kowalsick February 1994, Revised January 1999. www.cce.cornell.edu/counties/suffolk/grownet

STANDARD AND SPECIFICATIONS FOR VEGETATING SAND AND GRAVEL BORROW AREAS



Definition

Vegetating inactive borrow areas with sustainable herbaceous perennial plants.

Purpose

To provide appropriate vegetation to stabilize the soil, thus preventing wind and water erosion from causing on-site or off-site damages.

To create a more aesthetically pleasing view.

To enhance the wildlife habitat for greater diversity.

Condition Where Practice Applies

Sand and gravel borrow areas which have had EITHER the top portion of the soil profile replaced as 'topsoil' or overburden with greater than 15 percent fines included, OR the sand and gravel mined condition remains without 'topsoil' being replaced resulting in sand and gravel with less than 15 percent fines.

Design Criteria

1. Depending upon the type of unconsolidated material being mined, side slopes shall be graded in accordance with the New York State Mined Land Reclamation Law. Minimum requirements are: for fine sand, silt, clay the slope shall not exceed 2 horizontal to 1 vertical (26°); for coarse sand and gravel the slope shall not exceed 1.5 horizontal to 1 vertical (33°)
2. Rocks and other debris shall be removed from the site or buried during grading.

3. Surface soil layer shall be sampled from 0-6" in depth. Combine about 15 core samples to represent the site soil conditions. Analyze to determine pH, P and K.
4. Obtain a larger (5-10 lbs.) soil sample to represent the surface soil texture. Analyze for percent fines (particles less than .074 mm or 200 mesh sieve).
5. Apply soil amendments as indicated by soil chemical test. The surface to be seeded shall be limed to a pH of 6.0 using agricultural ground limestone. Fertilize to achieve a moderate level of available phosphorus (P₂O₅) and potassium (K₂O). If the soil must be fertilized before results of a soil test can be obtained to determine fertilizer needs, apply 50 pounds per acre of nitrogen. Incorporation will be accomplished following the seeding.
6. Select the appropriate seed mix based on percent fines and time of planting.
 - a. **IF 15 percent fines or less:** use the warm season grass mix. If fall planting is necessary, use a temporary cover to allow planting of the warm season grasses in early spring. Two (2) bushels of oats per acre is suggested as this will winter kill and not be competitive when the permanent seeding is made. Another option is small grain straw at two (2) tons per acre. Do not use old hay.
 - b. Warm Season Grass Table:

Species	Variety	Certified Seed PLS*/Acre (lbs.)
Switchgrass	Blackwell, Shelter Pathfinder, or Trailblazer	2
Coastal panicgrass	Atlantic	2
Big bluestem	Niagara	4
Little bluestem	Aldous or Camper	4
Sand bluestem	Goldstrike	2
Sand lovegrass	Nebraska 27 or Bend	2
Total mix (PLS/acre)		16 lbs.

*Pure Live Seed (PLS) = (% germination x % purity)/100

Pounds to be seeded = (100 x lbs. of 100% PLS required)/% PLS of commercial seed being used.

- c. **IF greater than 15 percent fines:** use a grass/legume mixture, or the warm season grass mix.
- d. Grass/Legume Table:

Species	Variety	Pure Live Seed Per Acre (lbs.)
Tall fescue	KY-31/Rebel	10
Redtop	Common	2
Perennial rye-grass	Pennfine/Linn	5
Birdsfoot trefoil*	Empire plus Pardee	8**

* legume in seed mixture needs to be inoculated.
 ** 4 lbs. of each is best. 8 lbs. of either one is good.

OR

Species	Variety	Pure Live Seed per Acre (lbs.)
Flatpea*	Lathco	10.0
Perennial pea*	Lancer	2.0
Crownvetch*	Penngift/Chemung	10.0
Tall fescue	KY-31/Rebel	10.0
Total Mix (lbs./acre)		32.0

* legume in seed mixture needs to be inoculated.

7. Planting instructions:

- a. Planting dates are very critical for warm season grasses. Very early spring (March/April) is best. The success rate decreases notably by the end of May. Fall seedings are not recommended. Grass/legume mixes may be reliably planted from early spring through June 15. Avoid June 16 through August 15. After August 15, seed anytime until ground freezes.

- b. A temporary cover of 2 bushels of oats may be seeded between August 15 and September 15 (oats will winter kill). This works well preparing for early spring seedings.
- c. Inoculate legume seed immediately prior to actual seeding. Use 4 times the standard agricultural rates.
- d. The seed mix must be uniformly broadcast. A hydroseeder works well or spread by hand if necessary. The use of spinner type seeders is difficult due to the lightweight and fluffy seed characteristics of some species.
- e. Incorporate the soil amendments and seed.
 - i. "Tracking" an area is using a bulldozer having cleats at least 1 inch in depth. Operation of the dozer shall be perpendicular to the contour and such that the entire area is covered by the tracks.

OR

- ii. Pulling a cultipacker over the entire site with the tines up or no deeper than 1 inch. This option only works if soil moisture is near field capacity.

- 8. Mulching is essential for immediate erosion control and uniform establishment of cool season grasses and legumes on sands and gravels. Use a heavier rate for the grass/legume seedings of 4000 lbs./ac. Use only small grain straw. Mulching of warm season grasses may not be necessary when runoff and sediment delivery is not an issue. If erosion control is necessary for warm season grass sites, mulch with 3000 lbs./ac. of small grain straw (not grass hay). On sites where mulch can be avoided, warm season grasses will respond favorably.
- 9. Anchor the mulch by using the bulldozer tracking technique. This may be done simultaneously with seed incorporation. Optional anchoring techniques and materials are available in the Mulching Standard.
- 10. Site protection is necessary to avoid wheel and tire damage.

STANDARD AND SPECIFICATIONS FOR PROTECTING VEGETATION DURING CONSTRUCTION



Definition

The protection of trees, shrubs, ground cover and other vegetation from damage by construction equipment.

Purpose

To preserve existing vegetation determined to be important for soil erosion control, water quality protection, shade, screening, buffers, wildlife habitat, wetland protection, and other values.

Condition Where Practice Applies

On planned construction sites where valued vegetation exists and needs to be preserved.

Design Criteria

1. Planning Considerations

A. Inventory:

- 1) Property boundaries, topography, vegetation and soils information should be gathered. Identify potentially high erosion areas, areas with tree windthrow potential, etc. A vegetative cover type map should be made on a copy of a topographic map which shows other natural and manmade features. Vegetation that is desirable to preserve because of its value for screening, shade, critical erosion control, endangered species, aesthetics, etc., should be identified and marked on the map.
- 2) Based upon this data, general statements should be prepared about the present condition, potential problem areas, and unique features of the property.

B. Planning:

- 1) After engineering plans (plot maps) are prepared, another field review should take place and recommendations made for the vegetation to be saved. Minor adjustments in location of roads, dwellings, and utilities may be needed. Construction on steep slopes, erodible soils, wetlands, and streams should be avoided. Clearing limits should be delineated (See Section 2).
- 2) Areas to be seeded and planted should be identified. Remaining vegetation should blend with their surroundings and/or provide special function such as a filter strip, buffer zone, or screen.
- 3) Trees and shrubs of special seasonal interest, such as flowering dogwood, red maple, striped maple, serviceberry, or shadbush, and valuable potential shade trees should be identified and marked for special protective treatment as appropriate.
- 4) Trees to be cut should be marked on the plans. If timber can be removed for salable products, a forester should be consulted for marketing advice.
- 5) Trees that may become a hazard to people, personal property, or utilities should be removed. These include trees that are weak-wooded, disease-prone, subject to windthrow, or those that have severely damaged root systems.
- 6) The vigor of remaining trees may be improved by a selective thinning. A forester should be consulted for implementing this practice.

2. Measures to Protect Vegetation

- A. Limit soil placement over existing tree and shrub roots to a maximum of 3 inches. Soils with loamy texture and good structure should be used.
- B. Use retaining walls and terraces to protect roots of trees and shrubs when grades are lowered. Lowered grades should start no closer than the dripline of the tree. For narrow-canopied trees and shrubs, the stem diameter in inches is converted to feet and doubled, such that a 10 inch tree should be protected to 20 feet.

- C. Trenching across tree root systems should be the same minimum distance from the trunk, as in "B". Tunnels under root systems for underground utilities should start 18 inches or deeper below the normal ground surface. Tree roots which must be severed should be cut clean. Backfill material that will be in contact with the roots should be topsoil or a prepared planting soil mixture.
- D. Construct sturdy fences, or barriers, of wood, steel, or other protective material around valuable vegetation for protection from construction equipment. Place barriers far enough away from trees, but not less than the specifications in "B", so that tall equipment such as backhoes and dump trucks do not contact tree branches.
- E. Construction limits should be identified and clearly marked to exclude equipment.
- F. Avoid spills of oil/gas and other contaminants.
- G. Obstructive and broken branches should be pruned properly. The branch collar on all branches whether living or dead should not be damaged. The 3 or 4 cut method should be used on all branches larger than two inches at the cut. First cut about one-third the way through the underside of the limb (about 6-12 inches from the tree trunk). Then (approximately an inch further out) make a second cut through the limb from the upper side. When the branch is removed, there is no splintering of the main tree trunk. Remove the stub. If the branch is larger than 5-6 inches in diameter, use the four cut system. Cuts 1 and 2 remain the same and cut 3 should be from the underside of the limb, on the outside of the branch collar. Cut 4 should be from the top and in alignment with the 3rd cut. Cut 3 should be 1/4 to 1/3 the way through the limb. This will prevent the bark from peeling down the trunk. Do not paint the cut surface.
- H. Penalties for damage to valuable trees, shrubs, and herbaceous plants should be clearly spelled out in the contract.

STANDARD AND SPECIFICATIONS FOR VEGETATING SAND DUNES AND TIDAL BANKS



Definition

Establishing and maintaining vegetative cover for coastal shoreline protection.

Purpose

1. To stabilize frontal sand dunes and provide for sand entrapment for dune building where possible and necessary.
2. To provide for protection of dune vegetation from foot traffic and vehicles.
3. To stabilize tidal banks and provide for long term protection.

Condition Where Practice Applies

On any coastal shoreline, including the Great Lakes, where vegetation can be expected to effectively stabilize a site.

Specifications

1. Sand dunes
 - A. Where stabilization of existing sand dunes and/or re-establishment of beachgrass is needed.
 - 1) Long Island and NYC area, use Certified 'Cape' American Beachgrass. Planting of frontal dunes should be accomplished by April 30. Refer to American Beachgrass Information Sheet for specific instructions.
 - 2) Lake Champlain and Great Lakes, use the Lake Champlain strain or species if adequate planting material is available. Use American beachgrass

guidelines for planting. 'Cape' will do well but is very aggressive compared with the Lake Champlain strain. Some people consider 'Cape' an invasive plant in these locations.

- 3) 'Atlantic' coastal panicgrass is excellent for back dune areas. Seed at 10 pounds pure live seed per acre. Refer to Vegetative Stabilization of Sand and Gravel Pits for determining the proper amount of pure live seed.
- 4) Immediately after planting, a sand fence (snow fence) will be built to protect the beachgrass from vehicle and foot traffic. The fence shall surround the planted area at a distance of 15 feet from the planted area. Passageways should be provided to allow pedestrians to cross the planted area at 300 foot intervals. Elevated boardwalks, or dune cross-overs, are desirable. Move the opening and boardwalk when beachgrass becomes weak.

- B. Where sand dunes must be reconstructed through sand entrapment, and shore conditions allow for sand deposition, a specialist from Sea Grant or the USDA Natural Resource Conservation Service shall make the determinations of feasibility. Appropriate permits for altering shorelines must be obtained prior to beginning work.

2. Building, Planting, and Maintaining Coastal Sand Dunes

Dune stabilization work must start at least one hundred (100) feet (horizontal distance) from the mean high tide (MHT) water line as a minimum. Whenever feasible, leave room for two or more dune lines for a double layer of protection. Dunes grow toward the sand supply, which is the ocean or the lake.

A. Building the dune:

1) Vegetatively.

Where blowing sand is available, a simple, relatively inexpensive and successful method exists for building dunes. It consists of planting American beachgrass strips parallel to the coastline. As the windblown sand moves off the beach landward, it drops its load of sand, beginning the natural cycle of dune growth. The row closest to the ocean should be at least 100 feet (horizontal distance) from the MHT line. The plantings will trap most of the windblown

sand, particularly during the growing season when the grass will continue to grow up through the newly trapped sand.

2) Sand Fences (Snow Fence Material).

The use of sand fence is effective and the material is readily available. It may be more expensive than building dunes vegetatively, but is less expensive than doing it with machinery. Normally it is also much faster than with vegetation alone.

To form a barrier dune, erect the sand fences, a minimum of 100 feet (horizontal distance) from the MHT line in two (three or four rows may be used where sufficient land area and sand is available.) parallel lines 30 or 40 feet apart. The fences should be roughly parallel to the water line and yet be as nearly as possible at a right angle to the prevailing winds. See Figure 3.3 on page 3.41. Where this is not possible, erect a single line of fence parallel with the water at least 140 feet from the MHT line and space 30 foot long perpendicular spurs 40 feet apart along the seaward side to trap lateral drift.

As the fences fill with sand, additional sets of fence can be placed over those filled until the barrier dune has reached a protective height.

To widen an old dune, the fencing should be set seaward at a distance of 15 feet from the old dune base.

Materials -

Use standard 4-foot sand (snow) fence. The fence should be sound and free of decay, broken wire, and missing or broken slats.

Wood posts, for fence support should be black locust, red cedar, white cedar, or other wood of equal life and strength. They do not need to be treated. They should be a minimum of 6 ft. 6 in. long and a minimum diameter of 3 inches. Standard fence post length is usually 7 ft.—8 ft. and should be used where possible.

Four (4) wire ties should be used to fasten the fence to the wood posts. Weave fence between posts so that every other post will have fence on ocean side of posts. Tie wires should be no smaller than 12 gauge galvanized wire.

The bottom of the fence should be set about 3 inches into the sand, or a mechanical grader could be used to push some sand against the bottom of fence.

3) Sand fence plus vegetation -

The combination of these two approaches is more effective than either one alone. The sand fence should be placed as discussed above. Bands of vegetation should then be planted parallel to the fence on the landward and seaward side. Each bank of vegetation should be about 20 feet wide and placed 10 to 15 feet from the sand fence. As the sand fills between the two fences, additional fence can be erected or the area between the fences can be planted. Such a combination can trap most of the wind blown sand crossing the dune area and produce a much broader based dune than either approach alone. See Figure 3.4.

3. Tidal Streams and Estuaries

The procedures to determine the effectiveness potential of stabilization of tidal streams and estuaries are found in Table 3.9.

Plants to be used are as follows:

- A. Certified 'Cape' American beachgrass
 - B. Certified 'Bayshore' smooth cordgrass
 - C. Certified 'Avalon' saltmeadow cordgrass
 - D. Certified 'Atlantic' coastal panicgrass
4. Coastal panicgrass is primarily used in freshwater tidal areas above high tide line. Frequently, it is seeded over top of saltmeadow cordgrass plantings.

5. Additional Reference

"Best of Beach Vegetation" by W. Curtis Sharp. Reprints from Parks and Recreation Resources, Volume 1, Nos. 1, 2, 4 & 5, 7 & 8. Published in January, February, May/June, July/August 1982.

Figure 3.3
Combination of Sand Fence and Vegetation for Dune Building

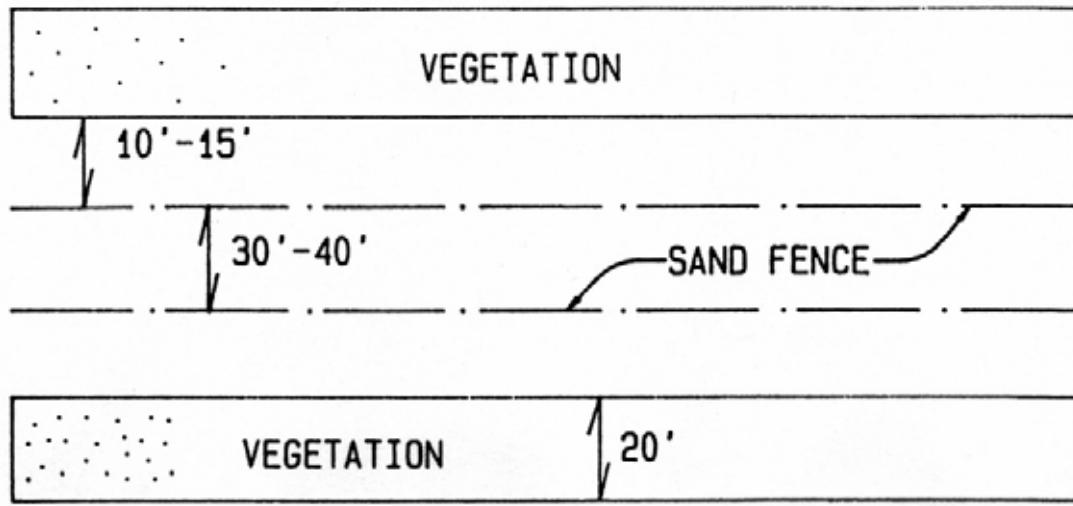

Figure 3.4
Typical Cross-Section Created by a Combination of Sand Fence and Vegetation

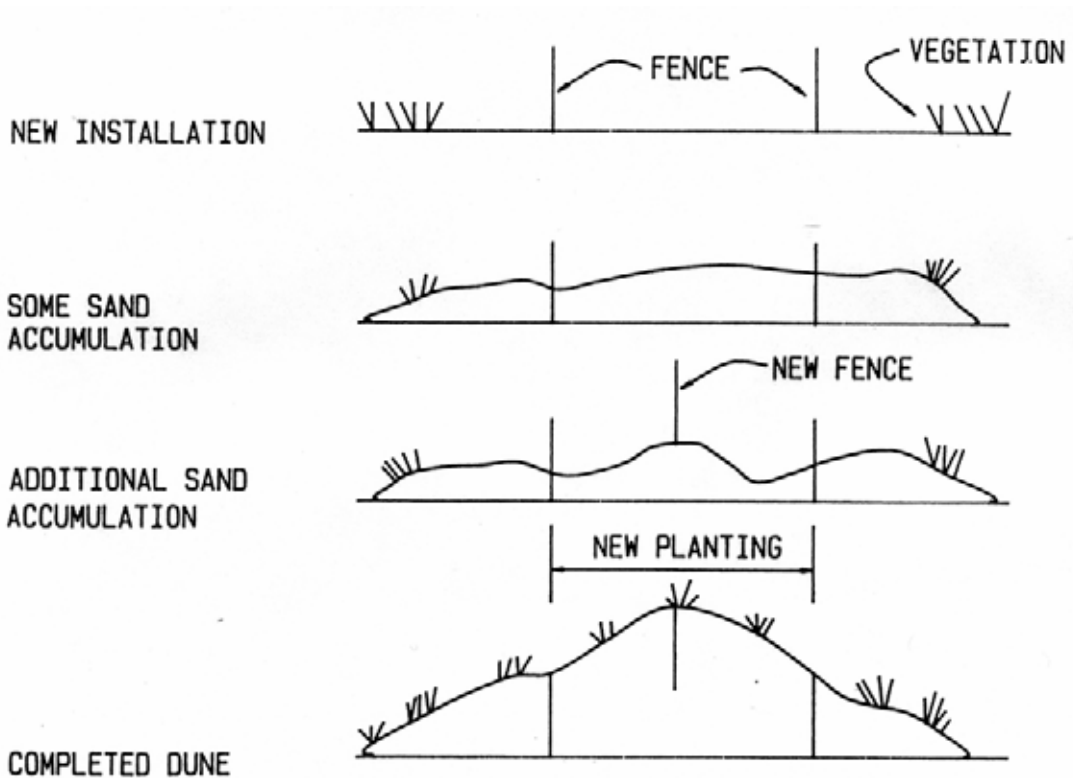

Table 3.9 Vegetative Treatment Potential for Eroding Tidal Shorelines

DIRECTIONS FOR USE

1. Evaluate each of the first four shoreline variables and match the site characteristics of the variable to the appropriate descriptive category.
2. Place the Vegetative Treatment Potential (VTP) assigned for each of the four variables in the right hand column.
3. Obtain the Cumulative Vegetative Treatment Potential for variables 1, 2, 3 & 4 by adding the VTP for each.
4. If it is 23 or more, the potential for the site to be stabilized with vegetative is very good and the rest of the table need not be used. If it is below 23, go to step 5.
5. Determine the VTP for shoreline variable 5 through 9 and obtain the cumulative VTP for variables 1-9.
6. Compare the cumulative VTP score with the Vegetative Treatment Potential Scale at the bottom of this page.

SHORELINE VARIABLES

DIRECTION FOR USE

VTP

The Vegetative Treatment Potential (VTP)
is located in bold type.

1. Fetch: Average distance in miles of open water measured perpendicular to the shore and 45 degrees either side of perpendicular to shore.	Less than 0.5 miles 8	0.5 thru 1.4 miles 7	1.5 thru 3.4 miles 4	3.5 thru 4.9 miles 2	over 5 miles ¹ 0	
2. General shape of shoreline for distance of 200 yards on each side of planting site.	Coves 8	Irregular shoreline 3		Headland or straight shoreline 0		
3. Shoreline orientation: General geographic direction the shoreline faces.	Any less than 1/2 mile fetch 5	West to North 3	South to West 2	South to East 1	North to East 0	
4. Boat traffic: Proximity of site to recreational & commercial boat traffic.	None 5	1-10 per week within 1/2 mi. of shore. 3	More than 10 per week within 1/2 mi. of shore. 2	1-10 per week within 100 yds. of shore. 1	More than 10 per week within 100 yds. of shore. 0	

Cumulative Vegetative Treatment Potential for Variables 1, 2, 3 & 4 _____

If this score is 23 or above, the potential for the site is very good and the rest of the table need not be used. If it is below 23, go to step 5 below.

5. Width of beach above mean high tide in feet	Greater than 10 ft. 3	10 ft. thru 7 ft. 2	6 ft. thru. 3 ft. 1	Less than 3 ft. 0	
6. Potential width ² of Planting area in feet	More than 20 ft. 3	20 ft. thru 15 ft. 2	14 ft. thru 10 ft. 1	Less than 10 ft. Do not plant	
7. On shore gradient slope from MLW to toe of bank.	below 8% 6	8% thru 14% 3	15% thru 20% 1	Over 20% 0	
8. Beach Vegetation	Vegetation below toe of slope 3		No vegetation below toe of slope 0		
9. Depth of sand ³ at mean high tide in inches.	more than 10 in. 3	10 in. thru 3 in. 2	less than 3 in. 0		

Cumulative Vegetative Treatment Potential for Variables 1-9 _____

1. Do not plant.
2. If tidal fluctuation is 2.5 feet or less, measure from MLW to toe of bank. If tidal fluctuation is over 2.5 feet, measure from MW to toe of bank.
3. Refers to depth of sand deposited by littoral drift over the substrata.

Vegetative Treatment Potential Scale

If the VTP is,		Potential of site to be
Between	And	Stabilized with Vegetation
40	33	Good
32	24	Fair
23	16	Poor

Figure 3.5

American Beachgrass Information Sheet

(*Ammophila breviligulata* Fern)

Adapted from USDA—NRCS Plant Guide²

Use: Major use is to stabilize moving sand along the Atlantic Sea coast and Great Lakes region. It is the best species for the initial stabilization of frontal dunes.

Useful as an erosion control plant on non-dune areas where soils are very sandy and the site conditions make establishment of seeded species very difficult. Also used on soils high in salinity such as industrial waste needing vegetative cover.

Description: American beachgrass is a leafy, spreading grass with many stems per clump. It may reach a height of two to three feet. The seed head is a spike-like panicle, about ten inches long, and appears in late July or August. Leaves are long and narrow, and may become rolled or folded as it matures.

One outstanding growth characteristic is the strong underground stems (rhizomes) that spread beneath the sand and give rise to many new plants. Its vigorous growth enables the plant to withstand heavy deposits of sand and the ability to grow up through deposits.

Adaptation: American beachgrass is native to the mid-Atlantic coastal region from Maine to North Carolina, and the Great Lakes region. It will grow on island sites, high in sand and/or saline content, provided adequate amounts of nitrogen and other nutrients are present.

Varieties: ‘Cape’ is the most recent variety and was developed by the Soil Conservation Service at the Cape May Plant Materials Center, Cape May Court House, N.J. ‘Hatteras’ developed by the Agricultural Experiment Station in North Carolina is a variety better adapted to southern climates.

Source: Both are commercially available vegetatively. Seed not available.

Establishment: The best time to plant beachgrass is from October 1 to April 30. If properly planted, good survival can be expected at any time during this period, except when soil is frozen. Summer plantings are not satisfactory. American beachgrass can be planted either by hand or by mechanical equipment designed for this work. The stems of plants called ‘culms’ are used for planting stock. Two or three culms are planted per hole. Space plants 18” by 18”, unless wind erosion is severe, then reduce spacing to 12” by 12”. Stagger the plantings in alternate rows to provide

maximum erosion control. On very stable areas where wind is not a factor, a spacing of 24” x 24” is suitable. An 18” x 18” spacing requires 58,500 culms (3 culms/planting unit) per acre, or 1,350 culms per 1,000 square feet.

Beachgrass culms must be planted at least 8” deep. This prevents plants from drying out, as well as being blown out by the wind. A tiling or ditching spade is an excellent tool for opening the planting hole. A two person crew works best in planting on frontal dunes and loose sandy areas. The culms and roots must be kept cool and moist before and during planting. Success of planting will increase if the stock is dormant or has made very little growth.

Fertilizer properly applied is the key to good vigorous growth, as coastal sands are rather infertile. Fertilize in March or April with 30 to 40 pounds of inorganic nitrogen per acre until desired density is obtained.



AMERICAN BEACHGRASS

Management: Once the stand is well established, the rate of fertilizer applied can be reduced by half, or applied only when the stand appears to be weakening.

Exclude vehicular traffic if possible and provide elevated boardwalks for pedestrians. Pedestrian and vehicular traffic that bends or breaks the culms will seriously damage the plants and may kill them. Move boardwalks, or dune cross-overs, when beachgrass underneath begins to weaken and become open, exposing the sand for potential blowing. On frontal dunes, any area devoid of protective cover is subject to blowing and eventual ruin. Replanting of beachgrass stands that become open should be an annual operating procedure.

Figure 3.6

Cordgrass Information Sheet

Smooth Cordgrass (*Spartina alterniflora*) and Saltmeadow Cordgrass (*Spartina patens*)

Adapted from USDA—NRCS Plant Fact Sheets²

Description: Smooth cordgrass, a long life perennial, is the dominant, most productive marsh plant in the regularly flooded inter-tidal zone along the Atlantic and Gulf coast from Newfoundland to Florida and Texas. Smooth cordgrass grows three to seven feet tall with stems up to 1/2 inch in diameter. The leaves are twelve to twenty inches long, tapering to a point. The seed heads, produced in

September and October, are ten to twelve inches long and hold twelve to fifteen spikelets, each two to three inches long. Its primary method of spreading is by vigorous, hollow rhizomes.

Saltmeadow cordgrass grows in salt marshes and sandy meadows along the Atlantic and Gulf coasts from Quebec to Florida and Texas. It occupies the area immediately above the inter-tidal zone. Mature plants are grayish green, usually one to three feet tall. The leaf sheath is round; the leaf blade is long and narrow, usually rolled inward giving a wiry appearance; the upper side of the leaf is rough. The seed heads produced in October have spikelets that grow almost at right angles to the rachis or main stem. Saltmeadow cordgrass reproduces rapidly by long, scaly, slender rhizomes.

Both smooth and saltmeadow cordgrasses are used by waterfowl as a source of food. Saltmeadow cordgrass is also used by muskrats for housing materials.

Uses: Because of their adaptation to brackish water, smooth and saltmeadow cordgrasses occur naturally or can be planted to stabilize eroding shorelines. Planted along the shoreline, the cordgrasses absorb the wave energy and collect the sediment brought in by water. As the sediment is dropped, the band of vegetation expands, pushing the mean high tide away from the tow of the bank, thus reducing the potential for continuous erosion.

Establishment of Shoreline Plantings: Smooth cordgrass is planted between the mean low water level and the mean high water level. Saltmeadow cordgrass is planted above

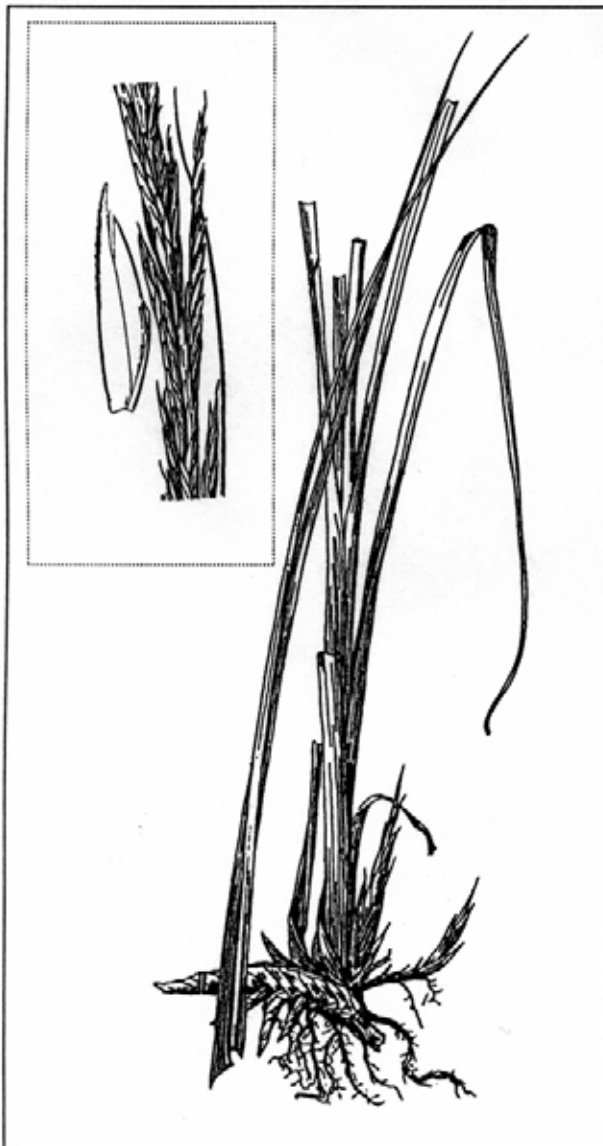

Spartina alterniflora



Spartina patens

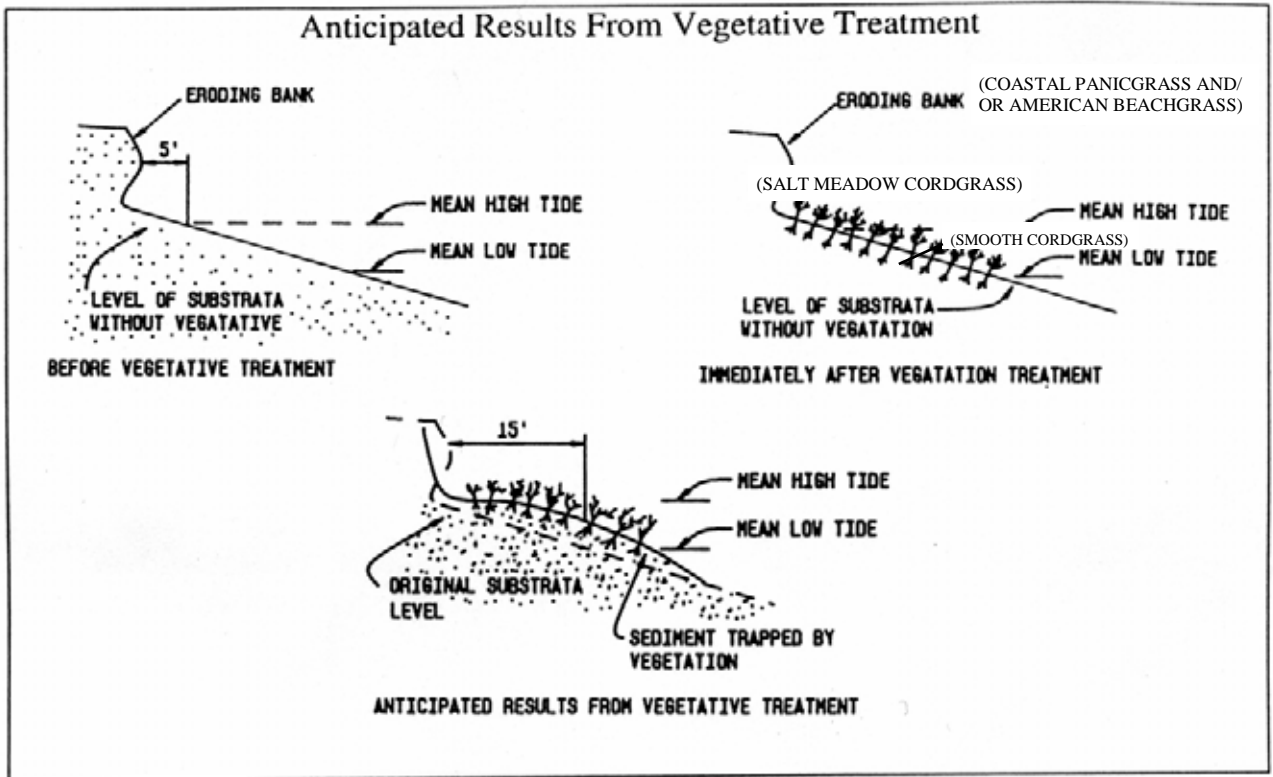

the smooth cordgrass from mean high water to the toe of the slope. If the distance from the mean high water to the toe of the slope exceeds 10 feet, American beachgrass should also be planted in the upper part of the slope.

Establishment of Plants: There are three types of plant materials that can be used for planting along the shoreline. One type is seedlings grown in peat pots. Such plants should be about 12 inches tall with 3-5 stems per container before they are large enough for transplanting. The container is planted with the root mass.

A second method is to grow the plants in containers which allow the plants with the root mass to slip out at the time of planting. Their size, etc., are the same as above. The advantage of this method is that it eliminates the barrier occasionally created by the peat pots that may produce a slight turbulence around the plant and wash it out.

A third type is to harvest culms from natural or cultivated stands which are then planted directly to the shoreline. If the plants are to be taken from natural stands, they should be growing in sandy substrata. The stands should be open and developing rather than dense and mature. The culms will be ready for digging and transplanting when the top growth is six to ten inches tall. Each culm should have a well developed root.

Methods one, two and three are equally recommended for smooth cordgrass. Methods one and two are recommended for saltmeadow cordgrass. Although method three can be

used, performance expectations will be less than with the other two methods. Coastal panicgrass can be planted using method one or be seeded.

Typical plantings consist of one row parallel to the shoreline. Transplants should be midway between the high and low tide elevations. Plant spacing within the row will vary according to the size of the transplant materials being used and the rate at which full coverage is desired. One gallon container stock are generally planted at 5' to 8' centers and plugs generally on 2'-3' centers. Smooth cordgrass typically produces 8'-10' rhizomes for lateral spread in one growing season. If two rows are planted, allow 5' between rows. The spacing to be used is influenced by the severity of the site. On sites that have a potential of being washed away, the spacing should be closer. In protected areas where there is little danger of the planting being initially destroyed, the spacing can be wider. The hole made in the substrata should fully accommodate the plant roots. Be sure to seal the hole by pressing the soil around the roots with your heel.

Planting Method/Fertilization:

Planting Methods: When planting trade-gallons, transplants should be planted in a hole. Post-hole diggers, gas drills with modified bits, or any other methods of digging are satisfactory. The planting hole should be the same size or only slightly larger than the root-ball and deep enough so that the top of the root-ball is flush or slightly below ground. The top of the root-ball should not protrude above

nor be more than 2” below normal ground. The planting hole should be tightly closed around the plant to prevent the plant from wobbling and plants should remain erect after planting.

Planting sites where high wave energy is a problem may require the addition of a plant anchor. A plant anchor consists of 1/4” steel re-bar bent into a hook (candy-cane shape) and pushed down into the soil so that the hook lays across the root-ball, pinning it to the ground. Anchors are generally about 30” in overall length and will add to the cost of the planting. However, anchors are generally necessary at unusually problematic sites to prevent plants from washing out.

When planting bare-root plugs, holes need only be approximately 3” in diameter and deep enough to cover the roots. Any style of tool that will punch a hole this size such as a dibble bar will work. Cupping the roots of the plug in hand and pushing down into the mud carefully will also work in more fluid soils. There are no plant anchors for plugs, and in practice, plugs should not be used at any site where wave energy is a factor.

Fertilization: There is no clear consensus on the effectiveness of fertilizer when used in saturated and/or anaerobic soils. However, the additional cost of fertilizer is a small investment given the overall cost involved in vegetative restoration.

Slow-release fertilizer tablets are commercially available in a range of weights and analyses. Recommended tablet weight should be between 15 and 25 grams and have a nitrogen content of not less than 15% and not more than 30%. When using tablets with trade-gallon plants, push the tablet into the top 3” of the root-ball immediately prior to or immediately after planting the transplant. The resulting

hole should be pinched closed. When using tablets with bare-root plugs, drop the tablet in the planting hole prior to inserting the plug.

Planting should be made between mid Spring and July 1. The early Spring plantings are more hazardous because of storms and less favorable soil temperatures. Actual dates are influenced by location. Late Spring plantings are preferred.

Site Suitability: A high percentage of plantings made on tidal shorelines fail due to shoreline conditions, storms, etc. Most shoreline conditions can be identified and their likelihood of contributing to success or failure estimated. They are shown in Table 3.9.

While the procedure outline in Table 3.9 has been tested against actual plantings, there is no guarantee the outcome of the planting will be as the guideline suggests. For instance, unexpected storms could completely eliminate the value of these guidelines and destroy the planting.

Management of Established Plantings: Plantings should be monitored frequently each year. Plants destroyed or washed out should be replanted as quickly as possible. All debris washed onto the plantings should be immediately removed to prevent smothering the plants.

Sources: Smooth and saltmeadow cordgrasses are available commercially. Because commercial sources are subject to change, contact your local USDA Natural Resources Conservation Service office for sources closest to you. ‘Bayshore’ smooth cordgrass, ‘Avalon’ saltmeadow cordgrass, and ‘Atlantic’ coastal panicgrass are recommended varieties for Long Island.

References

1. Sharp, W. C., C. R. Belcher and J. Oyler. Not dated. "Vegetation For Tidal Stabilization in the Mid-Atlantic States." USDA Soil Conservation Service, Northeast Regional Technical Center, Broomall, PA.
2. USDA Natural Resources Conservation Service. 2002. The PLANTS Database, Version 3.5. (<http://plants.usda.gov>). National Plant Data Center, Baton Rouge, LA 70874-4490. USA.

Page Intentionally Left Blank

**SECTION 4
BIOTECHNICAL MEASURES
FOR EROSION AND SEDIMENT CONTROL**

CONTENTS

	<u>Page</u>
List of Figures	
Introduction.....	4.1
Principles of Biotechnical Slope Protection.....	4.1
Planning Considerations.....	4.2
Plant Materials.....	4.3
Live Fascines.....	4.5
Brush Mattress.....	4.7
Live Stakes.....	4.9
Brush Layer.....	4.13
Live Cribwall.....	4.15
Tree Revetment.....	4.17
Branchpacking.....	4.19
Fiber Roll.....	4.21
References	

Section prepared by:

Donald W. Lake Jr., P.E., CPESC, CPSWQ
Engineering Specialist
New York State Soil & Water Conservation Committee

And

John A. Dickerson, Plant Materials Specialist
USDA Natural Resources Conservation Service
Syracuse, NY

List of Figures

<u>Figure</u>	<u>Title</u>	<u>Page</u>
4.1	Vegetated Rock Gabion Details.....	4.4
4.2	Live Fascine Details.....	4.6
4.3	Brush Mattress Details.....	4.8
4.4	Live Stake Details.....	4.10
4.4A	Live Stake Construction Specification.....	4.11
4.5	Brush Layer Details.....	4.14
4.6	Live Cribwall Details.....	4.16
4.7	Tree Revetment Details.....	4.18
4.8	Branchpacking Details.....	4.20
4.9	Fiber Roll Details.....	4.22

BIOTECHNICAL SLOPE PROTECTION MEASURES FOR EROSION AND SEDIMENT CONTROL

Introduction

Biotechnical slope protection is the specialized use of woody plant materials to stabilize soil. As noted in Section 1, one of the factors that affects erosion is vegetative cover. The more cover soil has, the more protected it is from the attacking forces of rainfall and runoff. Also working to hold the soil in place is the root mass that vegetation produces. Biotechnical measures generally combine basic engineering principles with plant science to create a system of stability for critical areas such as streambanks or roadside slopes. These systems may combine structural measures, such as those detailed in Section 5, with woody plants and shrubs to effect a strengthening of the soil structure and improved vegetative cover to resist surface erosion.

There are many advantages to biotechnical slope protection measures:

- they are often less expensive to install
- they do not require specialized skills to install
- generally, heavy equipment is not required
- they are environmentally compatible
- they provide a natural aesthetic appearance
- they provide wildlife habitat and cover
- they can be self repairing during and after stress
- they use natural/native materials

On the other hand, there are some disadvantages to these measures:

- higher risk due to less control with vegetation compared to structural practices
- require higher maintenance attention
- need an establishment period
- more sensitive to seasonal changes

Biotechnical slope protection is actually an old technology. These techniques have been practiced for centuries in Europe. The Natural Resource Conservation Service used and promoted this technology in the 1940's in Vermont on the Winooski River and also in New York on Buffalo Creek, where plant materials (willows) were used in combination with rock riprap, concrete slabs, pinned rock, and cellular modules to halt streambank erosion.

These biotechnical approaches are being "rediscovered" primarily due to their cost effectiveness over more traditional structural measures and for their environmental compatibility, aesthetics, and wildlife benefits. There are many areas in towns and counties in New York that

experience erosion on streambanks or sloughs on roadside slopes that could be controlled with biotechnical protection measures. The low cost and ease of installation is very attractive to units of government and highway departments looking to maximize their budget dollars.

Principles of Biotechnical Slope Protection

Generally a biotechnical slope protection system consists of both a structural or mechanical element and vegetative elements working together to stabilize a site-specific condition. Structural components are employed to allow establishment of vegetative elements, while at the same time providing a level of protection for stability. The vegetative components are not just landscaping plantings for a structural project; they also perform a functional role in preventing erosion by protecting the surface, while also stabilizing soil by preventing shallow mass movements.

Woody plant materials (usually dormant shrub willow branches) are placed into the soil in ways that provide an immediate degree of stability to the slope. As the branches take root and grow, the slope becomes more and more resistant to failure by shallow mass movements due to:

1. Mechanical reinforcement from the root system,
2. Soil moisture depletion through transpiration and interception, and
3. Buttressing and soil arching action from embedded stems.

The vegetation also tends to prevent surficial (surface or rainfall) erosion by:

1. Binding and restraining soil particles in place,
2. Filtering soil particles from runoff,
3. Intercepting raindrops,
4. Retarding velocity of runoff, and
5. Maintaining infiltration.

As the stability improves, native vegetation will volunteer, helping to blend the site into the surroundings.

There are many techniques used in biotechnical work. Some of the most common are:

Vegetated Rock Gabions—This is a combination of vegetation and rock gabions generally used for slope stabilization. Live branch cuttings are layered through the rock gabion structure to anchor in select earthfill. The cuttings protrude beyond the face of the gabion. The gabion standard is covered in the “standard specifications for retaining walls” in Section 5B. See Figure 4.1 for vegetative details.

Live Fascines—This technique uses bundles of branches which are staked into shallow trenches, then filled with soil. They are oriented along the contour and are placed in multiple rows to help stabilize a slope. See Standard and Specifications for Live Fascines.

Brush Mattress—This method uses hardwood brush layered along a streambank as a mattress and anchored in place with a grid of stakes and wire. The toe below the waterline is anchored by rock. This living blanket acts as a mulch for seedlings and plantings established in the bank. It also prevents erosion of sloped surfaces. See Standards and Specifications for Brush Mattress.

Live Staking—These are large stakes or poles sharpened at the bottom end and forced vertically into the soft earth along the waterline, usually about 1 foot apart. Depending on the size of the poles and the composition of the streambank, machinery may be required to force them into the ground or to prepare holes for planting. The poles will grow forming a very thick barrier to flow. See Figure 4.4 and Figure 4.4A.

Brush Layering—This technique is generally used to stabilize slope areas above the flow line of streambanks as well as cut and fill slopes. It involves the use of long branches that are placed with cut ends into the slope on bulldozed terraces. The tops protrude outside the finished slope. A layer usually includes three layers of brush separated with a thin (3 in.) layer of soil. On this layer a “lift” of 3-5 feet of soil is placed to form the next terrace and so forth. See Figure 4.5.

Live Cribwall—This is a combination of vegetation and structural elements generally used along streams where flowing water is a hazard. Layers of logs are alternated with long branches protruding out between them. The logs are spiked together and anchored into the bank with earthfill behind them to create a wall. The live stems help tie the logs together and screen the wall. See Figure 4.6.

Tree Revetment—This method incorporates entire trees (without the root wad) for bank stabilization in areas that are eroded or undercut, but not flashy or in need of heavy maintenance. Trees are overlapped and anchored to the earth for the purpose of absorbing energy and reducing

velocity, capturing sediment, and enhancing conditions for colonization of native species. See Figure 4.7.

Branchpacking—This technique alternates live branch cuttings with tamped backfill to repair small, localized slumps and holes in slopes. The alternating layers of branches and soil are placed between long posts driven in to the ground for support. This method is inappropriate for areas larger than 4-feet deep or 6-feet wide. See Figure 4.8.

Fiber Roll—A fiber roll is a coconut fiber, straw, or excelsior woven roll encased in netting of jute, nylon, or burlap used to dissipate energy along bodies of water and provide a good medium for the introduction of herbaceous vegetation. This technique works best where water levels are relatively constant. The roll is anchored into the bank and, after suitable backfill is placed behind the roll, herbaceous or woody vegetation can be planted. See Figure 4.9.

Properly designed structural measures may be necessary to help protect the toe or face of a slope against scour or erosion from moving water and against mass-moving of soil. These structures are generally capable of resisting much higher lateral earth pressures and higher shear values than vegetation. They can be natural, such as fieldstone, rock and timbers; or, they can be artificial like concrete and steel. Some structural measures can be a combination like gabions, which are wire baskets containing stone. Gabions can be used as retaining walls, grade stabilization structures and slope protection. Many of these types of structures can be planted or vegetated with materials to strengthen the system. See Figure 4.1.

Planning Considerations

There are many facets that need to be considered when designing a biotechnical system for a site:

Method – What is the appropriate method for the particular problem encountered?

Materials – What type should be selected? How much is needed to do the job? Where can they be obtained?

Schedule – When is the best time to maximize the successful rooting or germination of materials?

Equipment – Since this process is somewhat labor intensive, it is necessary to make sure the proper type and amount of tools, such as shovels, pick axe, tile spade, hammers, etc. are available for proper installation of material.

Site characteristics – The need for engineering structures will depend on potential hazards, management of site water, soil conditions, and site access. Aesthetics and follow-up

maintenance are also important considerations. Protection from livestock is mandatory.

Streambanks – Generally applicable where flows are less than 6 feet per second and the stream bottom is not subject to degradation and scour. Protection should be carried to the average high water elevation.

Plant Materials

Plant materials for biotechnical slope protection may be obtained in two basic ways. One method is to locate stands of appropriate species and obtain easements to harvest materials from these stands for incorporation into the project. Criteria for selecting native species are: easy rooting; long, straight, flexible whips; and plentiful supply near the site.

A second method is to grow and harvest materials from managed production beds that are maintained for commercial distribution. This allows selection of cultivars that have proven performance records and high survival rates.

The most popular materials in use today are the shrub willows. Willows have a tremendous ability to sprout roots and stems when in contact with moist soil. Willows are found growing in all parts of the world, so biotechnical

slope protection techniques employ them more than any other group of plants. Two of the tested, proven willow cultivars in the Northeast are:

- ‘Streamco’ purpleosier willow (*Salix purpurea*)
- ‘Bankers’ dwarf willow (*Salix cottetii* – hybrid)

‘Streamco’ and ‘Bankers’ willow are both shrubs. ‘Streamco’ has an ultimate height of 15-20 feet, while ‘Bankers’ is limited to 6-8 feet. Commercial and state nurseries in the Northeast are producing supplies of both species.

In addition to willows, redosier dogwood and poplars are other groups of plants effective for use in biotechnical systems. Species such as elderberry or forsythia can also be used to add biodiversity to a site.

All plant materials should be installed on site within 8 hours of cutting, unless provisions for proper storage are made. Materials should be fresh, dormant, and non-desiccated when installed.

**Figure 4.1
Vegetated Rock Gabions**

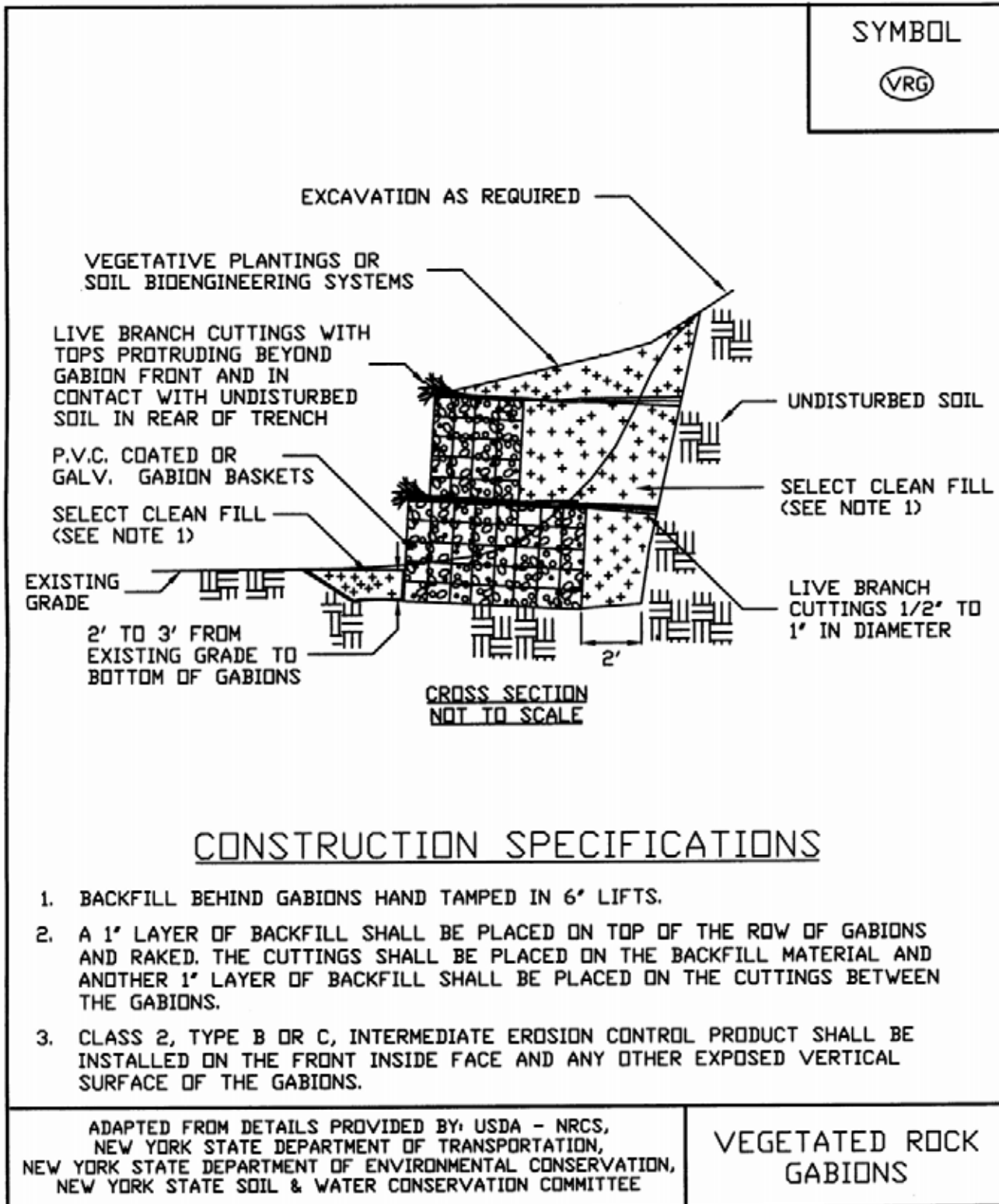

STANDARD AND SPECIFICATIONS FOR LIVE FASCINES



<u>Slope</u>	<u>Contour Interval</u>
1:1	3'
1.5:1	3'
2:1	4'
2.5:1	4'
3:1	5'
3.5:1	5'
4:1	6'
6:1	8'

See Figure 4.2 for details.

Definition

The placement of groups or bundles of twigs, whips, or branches in shallow trenches, on the contour, on either cut or fill slopes.

Purpose

To stabilize slopes by slowing water movement down the slope, increasing infiltration, trapping slope sediments, and increasing soil stability with root systems.

Conditions Where Practice Applies

On sloping areas such as road cuts, slumped areas, road fills, gullies, and streambanks subject to erosion, seepage, or weathering, which have a low to medium hazard potential should slope failure occur. Slopes must be 1:1 or flatter.

Design Criteria

Materials—Shall be a native or nursery grown cultivar that is capable of performing the intended function.

Fascines—Shall be made by forming the bundles 8-15 feet long, 4 inches minimum in diameter, from stems no more than 1 inch in diameter.

Overlap—Fascines should be overlapped at the tapered ends a minimum of 1-foot.

Vertical Spacing—The spacing of the contours for the fascines is dependent on the degree of erosion or potential erosion at the site. Factors include slope steepness, soil type, drainage, and existing ground cover. The following is a general guide to selecting contour interval:

Construction Specifications

1. Fascines shall be 4 inches minimum in diameter.
2. Prior to placing the fascines, the slope shall be smoothed and graded with obstructions removed. Any structural measures for revetment, drainage, or surface water management will be installed first.
3. Working from the bottom of the slope to the top, excavate the fascine trench. Place fascines in trench and anchor with stakes spaced at 24 inches. Cover fascines with soil leaving about 10% exposed to view. Fascines shall be overlapped 12 inches minimum in the trench.
4. Soil shall be worked into the fascine and compacted by walking on the fascine being covered.
5. All disturbed areas should be seeded upon completion of fascine placement.

Maintenance

Regular inspection and maintenance of fascine installations should be conducted especially during the first year of establishment. Loose stakes should be reset and settled fill areas should be brought back to grade. Prompt corrections to gullies, sloughs or other evident problems shall be made.

**Figure 4.2
Live Fascine**

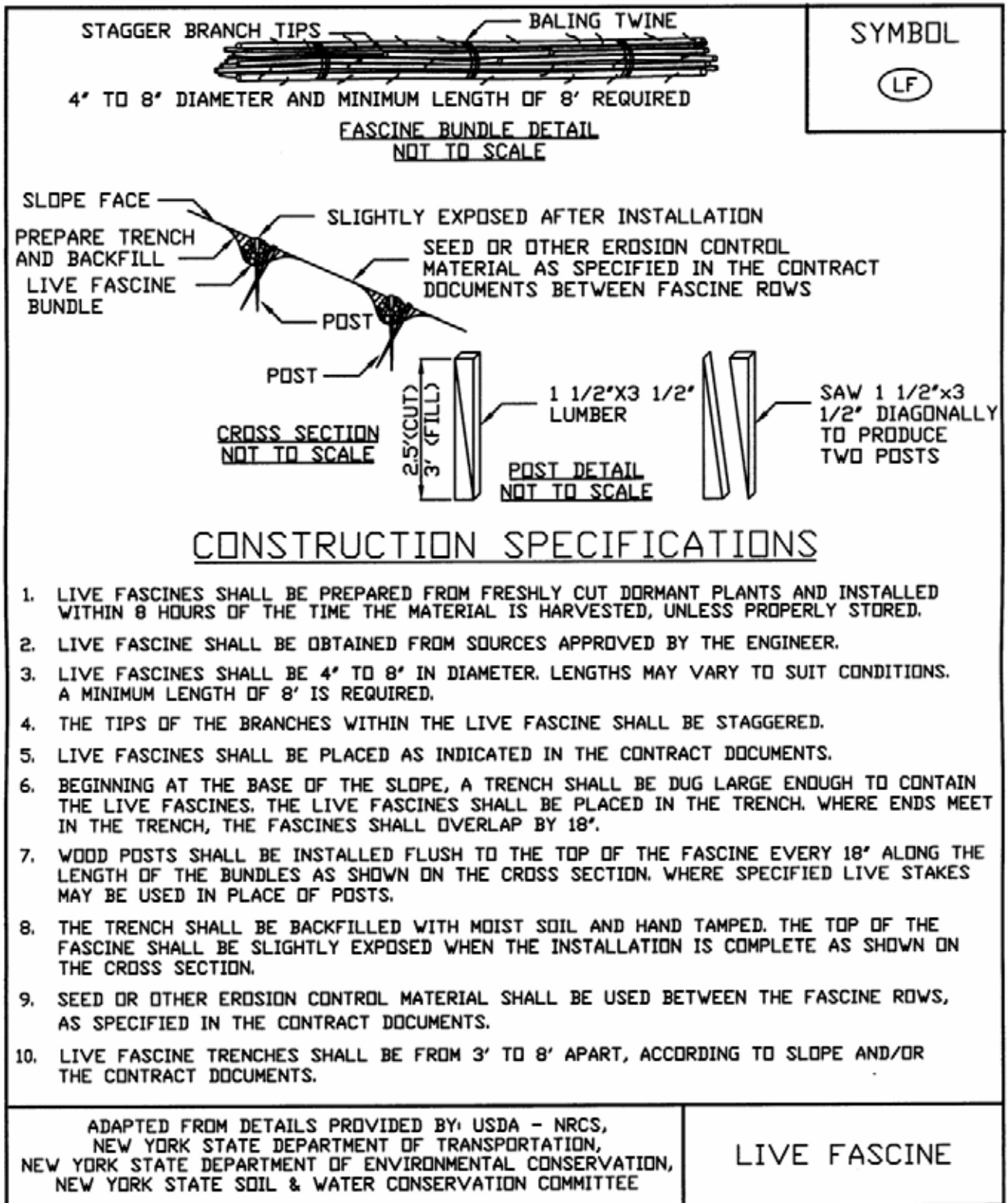

STANDARD AND SPECIFICATIONS FOR BRUSH MATTRESS



Definition

A mulch or mattress of brush laid on a slope and fastened down with stakes and wire.

Purpose

To protect the soil surface on slopes from erosive forces through the generation of a dense stand of woody vegetation.

Conditions Where Practice Applies

Brush mattresses are used primarily on streambanks where the velocity is less than 6 feet per second and excessive runoff from streamflow has created erosive conditions. This practice can resist temporary inundation, but not scour or undercutting.

Design Criteria

Layer Thickness—The brush shall be a minimum of 3 inches thick (excluding top soil layer).

Height—The mattress shall be placed up the bank to the bankfull elevation. The toe of the mattress should be located in a fascine trench.

Slope—The maximum slope shall be 1.5:1.

Anchoring—The mattress shall be anchored on the slope by a grid of 3-foot stakes driven on 3-foot centers each way. No. 9 wire is then wound between the stakes, which are driven to secure the mattress. The upstream edge of the mattress should be keyed into the bank 2 feet.

Materials—The plant materials should be willow and dogwood brush placed as shown in Figure 4.3.

Construction Specifications

1. Prepare slope surface by grading to a uniform, smooth surface, clear of obstruction. Slopes should be graded before the brush mattress is installed.
2. The fascine toe should be installed first. Then lay brush beginning at the downstream end of the work.
3. The butt end of the brush will be placed upstream and plant materials inclined approximately 30 degrees.
4. The upstream edge of the mattress will be keyed into the slope 2 feet. Stakes will be driven throughout the mattress on 3-foot centers each way beginning along the toe of the mattress.
5. No. 9 wire will be attached to the stakes and tightened to secure the mattress.
6. Slope areas above the mattress will be shaped and seeded.

Maintenance

Scheduled inspections the first year are necessary to make sure the anchoring system is sound. Broken wire or missing stakes shall be replaced immediately. Any missing toe material missing shall be replaced.

**Figure 4.3
Brush Mattress**

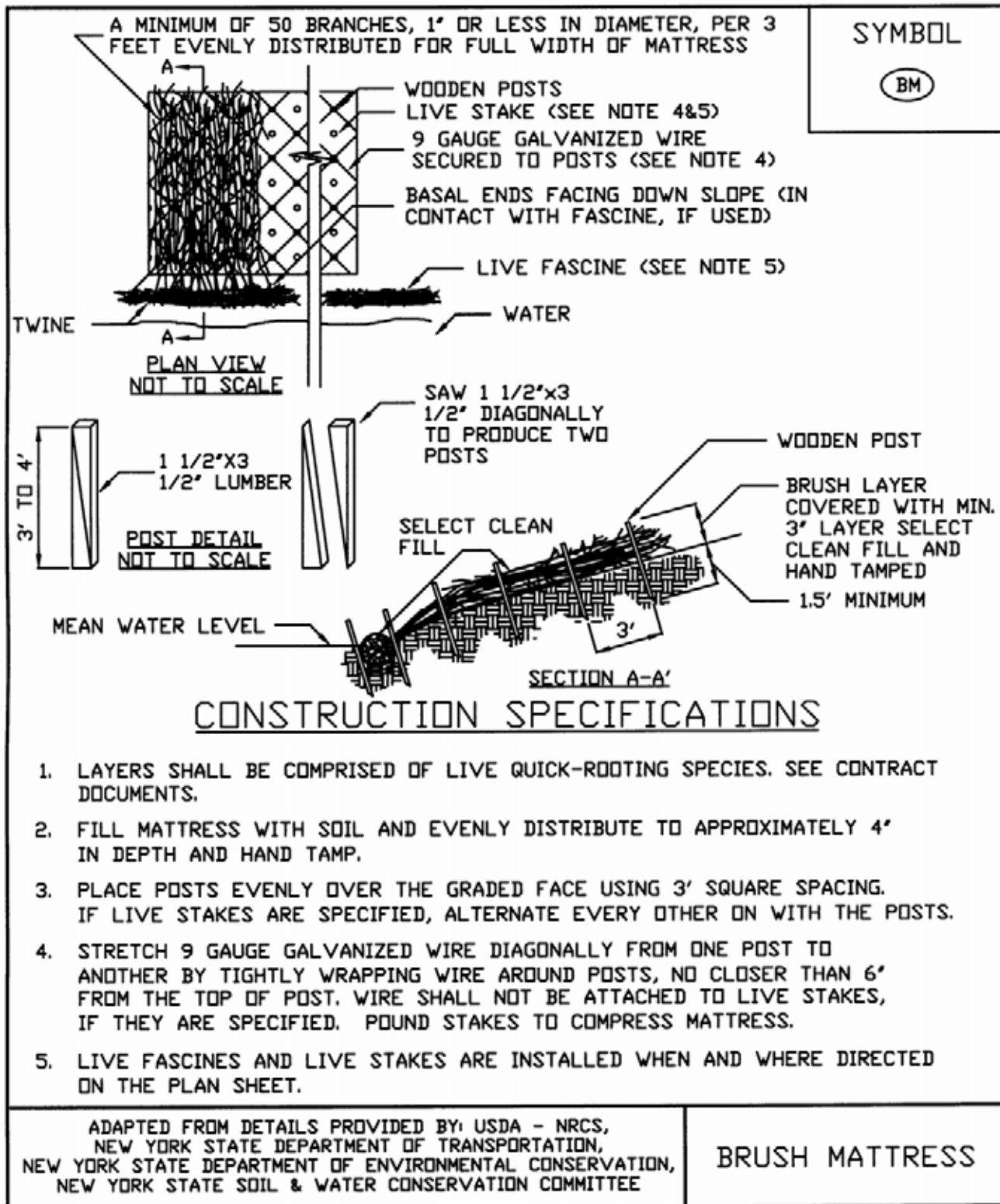

STANDARD AND SPECIFICATIONS FOR LIVE STAKES



Definition

A stake or pole fashioned from live woody material.

Purpose

To create a living root mat that stabilizes the soil by reinforcing and binding soil particles together and by contributing to the reduction of excess soil moisture.

Conditions Where Practice Applies

Live stakes are an appropriate technique for repair of small earth slips and slumps that are frequently wet and for stabilizing raw streambanks. This technique is for relatively uncomplicated site conditions when construction time is limited and an inexpensive vegetative method for stabilization is derived. It is not intended where structural integrity is required nor to resist large, lateral earth pressures.

Design Criteria

1. Live stakes shall be 1 - 2 inches in diameter and 2-6 feet long, depending on site application.
2. No leaf buds shall have initiated growth beyond 1/4" and the cambium layer shall be moist, green and healthy.
3. All material shall be maintained in a continuously cool, covered, and moist state prior to use and be in good condition when installed.

4. Materials harvested on site shall be installed the same day they are prepared. Nursery grown material shall be maintained in a moist condition until installed.
5. Installation Details
 - a. The lengths of live cuttings/live stakes depends upon the application. If through riprap, the length shall extend through the surface of the stone fill. At least half the length shall be inserted into the soil, below the stone fill.
 - b. Minimum 2 to 4 inches and two live buds of the live stake shall be exposed above the stone filling.
 - c. Live stakes shall be cut to a point on the basal end for insertion in the ground.
 - d. Use a dead blow hammer to drive stakes into the ground. The hammer head should be filled with shot or sand. A dibble, iron bar, or similar tool shall be used to make a pilot hole to prevent damaging the material during installation.
 - e. Live cuttings shall be inserted by hand into pilot holes.
 - f. When possible, tamp soil around live stakes.
 - g. Care shall be taken not to damage the live stakes during installation. Those damaged at the top during installation shall be trimmed back to undamaged condition.

Maintenance

Due to the susceptibility of plant materials to the physical constraints of the site, climate conditions, and animal populations, it is necessary to inspect installations frequently. This is especially important during the first year or two of establishment. Plant materials missing or damaged should be replaced as soon as possible. Sloughs or breaks in drainage pattern should be reestablished for the site as quickly as possible to maintain stability.

**Figure 4.4
Live Stake**

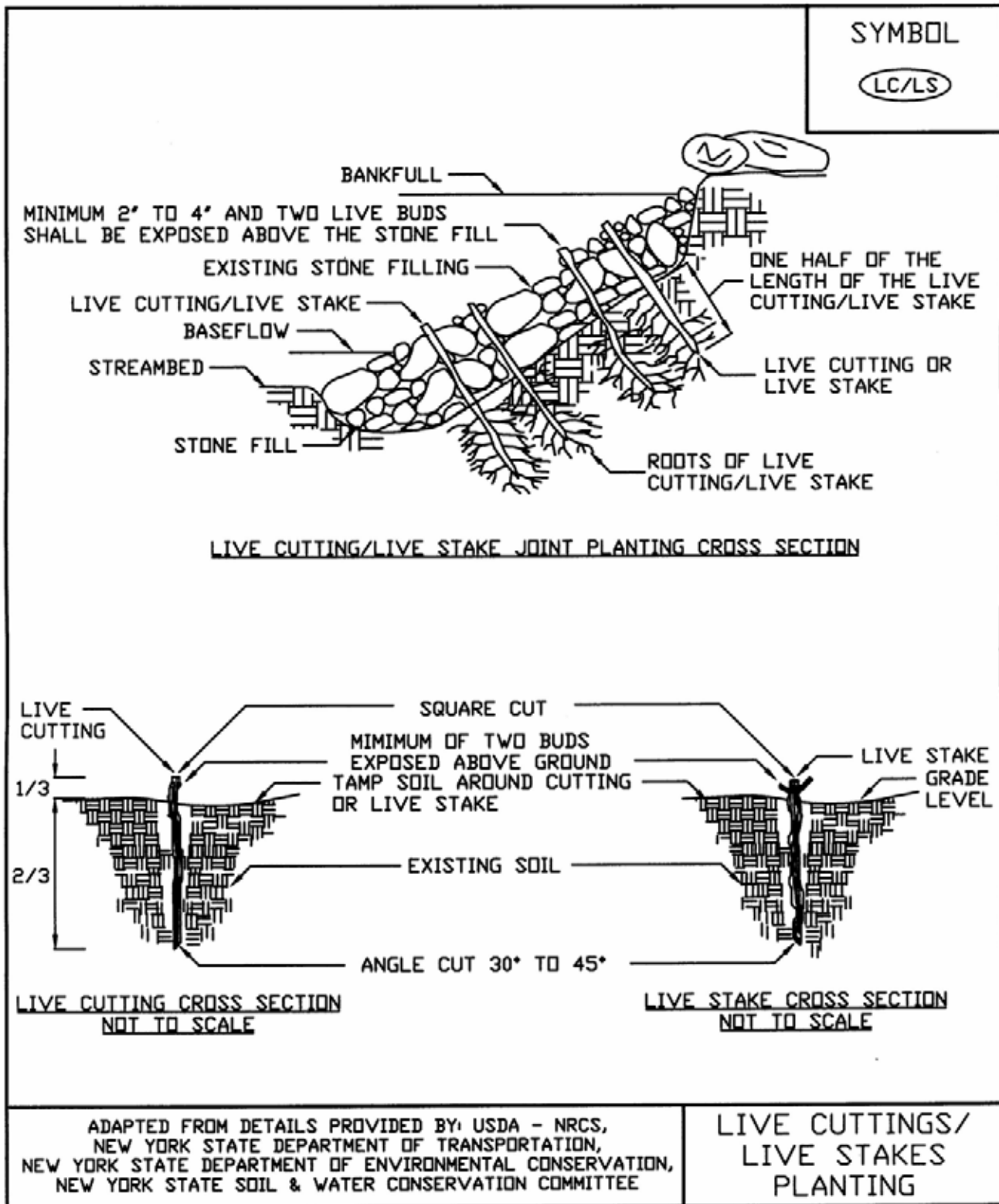



Figure 4.4A Live Stake Construction Specifications

	<p>SYMBOL</p> 
<p><u>CONSTRUCTION SPECIFICATIONS</u></p>	
<ol style="list-style-type: none"> 1. CARE SHALL BE TAKEN NOT TO DAMAGE THE LIVE CUTTINGS/LIVE STAKES DURING INSTALLATION. THOSE DAMAGED SHALL BE LEFT IN PLACE AND SUPPLEMENTED WITH AN INTACT LIVE CUTTING/LIVE STAKE. 2. THE LENGTHS OF LIVE CUTTINGS/LIVE STAKES DEPENDS UON THE APPLICATION. THE LENGTH SHALL EXTEND THROUGH THE SURFACE OF THE STONE FILL. AT LEAST HALF THE LENGTH SHALL BE INSERTED INTO THE SOIL, BELOW THE STONE FILL. 3. A PILOT HOLE IS REQUIRED TO ENSURE THAT THE LIVE CUTTING/LIVE STAKE IS NOT DAMAGED WHEN DRIVEN THROUGH THE STONE FILLING. ACCESS SHALL BE MADE THROUGH THE USE OF A DIBBLE BAR, OR SIMILAR TOOL TO WORK AN OPENING THROUGH THE ROCK LAYER. 4. MINIMUM 2" TO 4" AND TWO LIVE BUDS OF THE LIVE CUTTING/LIVE STAKE SHALL BE EXPOSED ABOVE THE STONE FILLING. 5. LIVE CUTTINGS SHALL RANGE FROM 1/2" TO 1" IN DIAMETER AND BE FROM 1' TO 4' IN LENGTH. 6. LIVE STAKES SHALL RANGE FROM 1" TO 4" IN DIAMETER AND BE FROM 5' TO 6' IN LENGTH. 7. SEE CONTRACT DOCUMENTS FOR SPECIES, SIZE, SPACING, LOCATION, AND FINAL DETERMINATION ON USE OF CUTTINGS OR STAKES. 8. LIVE CUTTINGS/LIVE STAKES SHALL BE CUT TO A POINT ON THE BASAL END FOR INSERTION IN THE GROUND. 9. USE A DEAD BLOW HAMMER TO DRIVE STAKES INTO THE GROUND. THE HAMMER HEAD SHOULD BE FILLED WITH SHOT OR SAND. A DIBBLE, IRON BAR, OR SIMILAR TOOL SHALL BE USED TO MAKE A PILOT HOLE TO PREVENT DAMAGING THE MATERIAL DURING INSTALLATION. 10. LIVE CUTTINGS SHALL BE INSERTED BY HAND INTO PILOT HOLES. 11. WHEN POSSIBLE, TAMP SOIL AROUND LIVE CUTTINGS/LIVE STAKES. 12. ANY LIVE CUTTING/LIVE STAKE THAT IS DAMAGED SHALL BE LEFT IN PLACE AND SUPPLEMENTED WITH AN INTACT LIVE CUTTING/LIVE STAKE. 	
<p>ADAPTED FROM DETAILS PROVIDED BY: USDA - NRCS, NEW YORK STATE DEPARTMENT OF TRANSPORTATION, NEW YORK STATE DEPARTMENT OF ENVIRONMENTAL CONSERVATION, NEW YORK STATE SOIL & WATER CONSERVATION COMMITTEE</p>	<p>LIVE CUTTINGS/ LIVE STAKES PLANTING SPECS</p>

STANDARD AND SPECIFICATIONS FOR BRUSH LAYER



Brush layer cuttings shall be 1/2 to 2 inches in diameter and be from dormant plants. No leaf buds shall have initiated growth beyond 1/4" and the cambium layer shall be moist, green, and healthy. The cuttings shall be long enough to contact the back of the bench with the growing tips protruding out of the slope face.

Care shall be taken not to severely damage the live branch cuttings during installation. Damaged cuttings will be replaced prior to backfilling.

Starting at the toe of the slope, excavate benches along the contour of the slope. The benches shall range from 2 to 3 feet wide and the surface of the bench shall be angled so the front edge is higher than the back of the bench (See Figure 4.5). The benches shall be spaced according to the previous table, Slope Distance Between Layers (ft).

Live branch cuttings shall be placed on the bench in a crisscross or overlapping configuration in layers 3 - 4 inches thick. Backfill shall be placed on top of the live branch cuttings and tamped in 6 inch lifts. Small plate compactors may be used to settle the soil. Areas between the rows of brush layers shall be stabilized by seeding or other appropriate erosion control method.

Definition

A brush layer is a horizontal row of live branch cuttings placed in soil with other similar rows, spaced a specific vertical distance apart.

Purpose

To stabilize cut and fill slope areas by reinforcing the soil with unrooted branch stems, trap debris on slope, dry excessively wet sites, and redirect adverse slope seepage by acting as horizontal drains.

Conditions Where Practice Applies

Generally applicable to stabilize slope areas above the flow line of streambanks as well as cut and fill slopes. Brush layers can be used on slopes up to 2:1 in steepness and 20 feet in height.

Design Criteria

The spacing requirements for brush layer rows is dependent on the slope steepness and moisture content. Spacing shall conform with the following table.

Slope Distance Between Layers (feet)

Slope H : V	Wet Slope	Dry Slope	Max Slope Length
2 to 2.5:1	3'	3'	15'
2.5 to 3.5:1	3'	4'	15'
3.5 to 4.0:1	4'	5'	25'

Maintenance

Due to the susceptibility of plant materials to the physical constraints of the site, climate conditions, and animal populations, it is necessary to inspect installations frequently. This is especially important during the first year or two of establishment. Plant materials missing or damaged should be replaced as soon as possible. Sloughs or breaks in drainage pattern should be reestablished for the site as quickly as possible to maintain stability.

**Figure 4.5
Brush Layer**

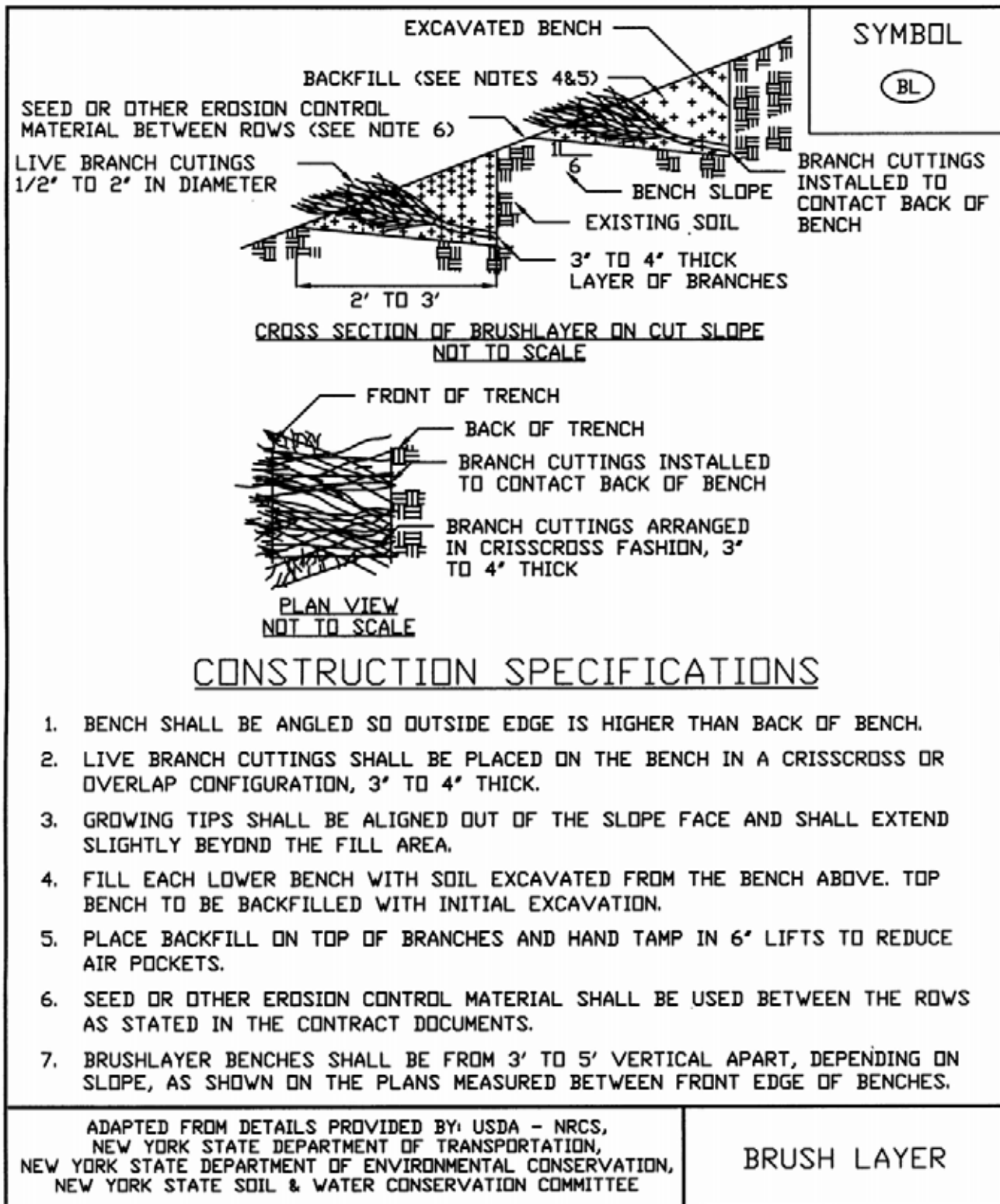

STANDARD AND SPECIFICATIONS FOR LIVE CRIBWALL



Definition

A hollow box-like structure made with an interlocking arrangement of untreated logs or timber members spiked together and anchored into the slope. The structure is filled with suitable earthfill materials and layers of live branch cuttings which root inside the structure and extend into the slope.

Purpose

To protect exposed or eroded streambanks from the erosive forces of flowing water and stabilize the toe of slope to reduce steepness.

Conditions Where Practice Applies

Generally applicable where flows are less than 6 feet per second and no degradation of the streambed occurs. Can reduce steepness and provide stability where space is limited and a vertical structure is needed. It is not intended to be used where the integrity of a road or structure is dependant on the cribwall since it is not designed to resist large lateral earth pressures.

Design Criteria

1. The vegetated cribwall structure shall be designed to a height for its intended purpose.
2. Live branch cuttings should be 1/2 to 2 inches in diameter and long enough to reach from the front of the structure to the undisturbed soil.
3. The structure will be built with a batter of 1 to 12. Large spikes or rebar are required to secure the logs or timbers together (10 inches minimum).

4. Only untreated logs or timber shall be used in the cribwall.
5. Installation begins with excavating to a stable foundation 2' - 3' below the ground elevation at the toe of slope with the back of the excavation (to the slope) slightly deeper than the front.
6. The first course of logs is placed along the front and back of the excavated foundation approximately 4-5 feet apart and parallel to the slope contour.
7. The next course is placed at right angles on top of the previous course to overhang the front and back of the previous logs by 3-6 inches.
8. Each course is placed in the same manner and fastened to the preceding course to the desired grade.
9. Stone fill is placed in the bottom of the structure up to the ground level and up to the base flow in a stream channel.
10. Once the cribwall structure reaches the existing ground elevation, live branch cuttings are placed on the stone fill parallel with the slope contour.
11. The cuttings are then covered with select clean fill with a maximum size of 3 inches and not more than 20 percent passing a 200 sieve size.
12. The live branch cuttings shall be placed at each course followed by the select fill to the top of the structure with the growing tips slightly protruding from the cribwall face.
13. The plant materials shall be kept in a healthy growing condition by watering. Also see maintenance below.

Maintenance

Due to the susceptibility of plant materials to the physical constraints of the site, climate conditions, and animal populations, it is necessary to inspect installations frequently. This is especially important during the first year or two of establishment. Plant materials missing or damaged should be replaced as soon as possible. Sloughs or breaks in drainage pattern should be reestablished for the site as quickly as possible to maintain stability.

Figure 4.6
Live Cribwall

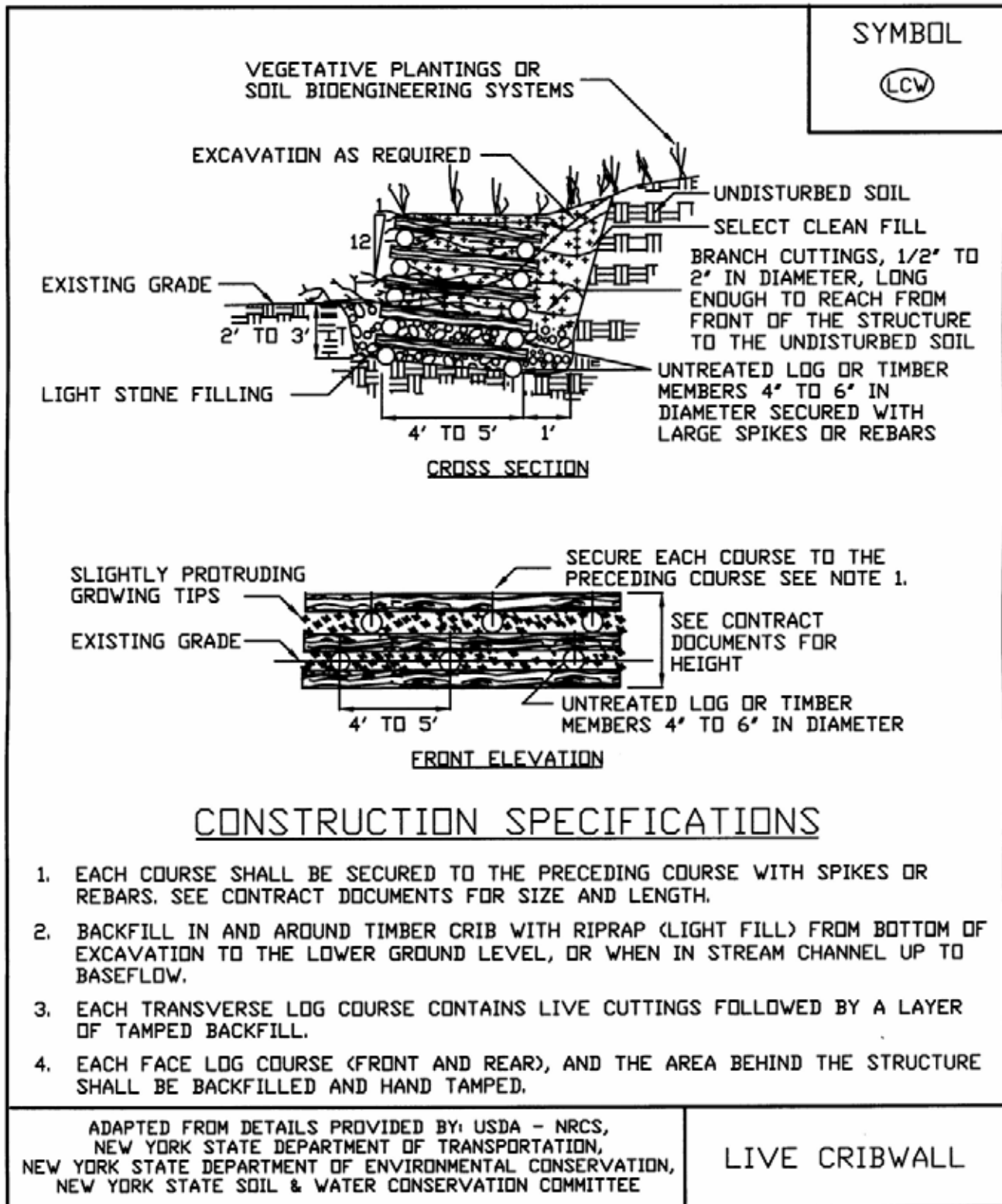

STANDARD AND SPECIFICATIONS FOR TREE REVETMENT



Definition

A tree revetment consists of a tree trunk and branches, without root wad, cabled to an earth anchor, which is buried in the streambank.

Purpose

To reduce streambank erosion by absorbing energy and reducing velocity, capturing sediment, and enhancing conditions for planting or colonization of native species.

Conditions Where Practice Applies

This practice is appropriate for streambanks that are eroded or undercut. It should not be used near bridges or other structures where there is a potential for downstream damage if a revetment dislodges. Their use should be limited to non-flashy streams where the needs for future maintenance are not important.

Design Criteria

1. Trees shall be sound, recently felled spruce or fir of 6" or greater diameter and at least 20 feet in length.
2. Trees are placed initially at the base flow elevation with the butt end upstream. Multiple tree revetments shall be overlapped by 25% of their length, working from downstream to upstream.
3. Each tree shall have their branches trimmed off on the bank side and have two anchors, one near the butt end and the other at 3/4 distance up the trunk.
4. The tree shall be fastened with galvanized cable to the anchors, which will be commercially manufactured earth anchoring systems. The butt end cable shall also be attached to the stem of the next tree at 3/4 the distance from the base, as it is placed to the outside of the previous tree.
5. Excavate and backfill as necessary to fit the tree revetment to the site.

Maintenance

Due to the susceptibility of plant materials to the physical constraints of the site, climate conditions, and animal populations, it is necessary to inspect installations frequently. This is especially important during the first year or two of establishment. Plant materials missing or damaged should be replaced as soon as possible. Sloughs or breaks in drainage pattern should be reestablished for the site as quickly as possible to maintain stability.

**Figure 4.7
Tree Revetment**

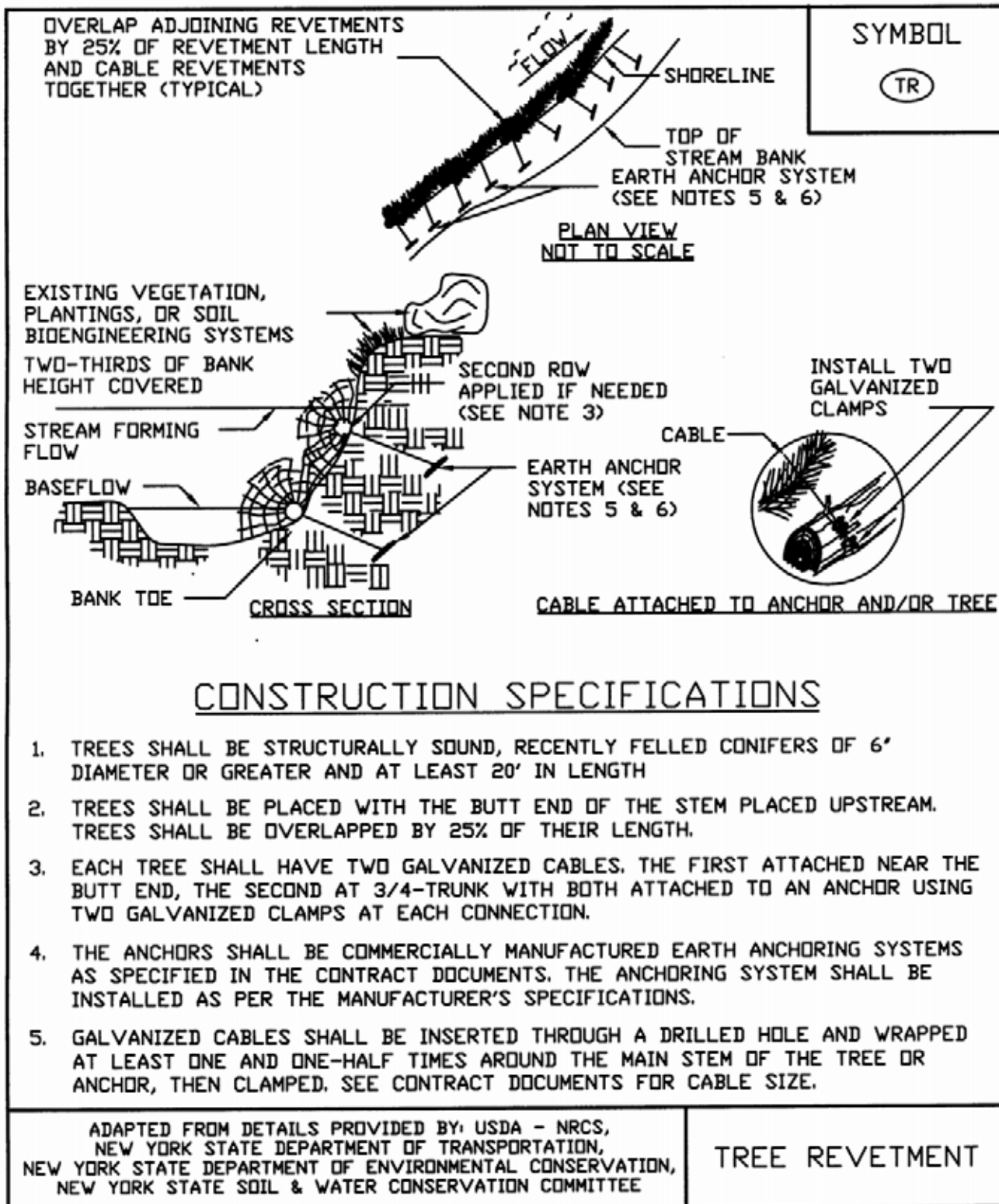

STANDARD AND SPECIFICATIONS FOR BRANCHPACKING



Definition

Branchpacking consists of alternate layers of live branch cuttings and tamped backfill to repair small, localized slumps and holes in slopes.

Purpose

The purpose of branchpacking is to provide repair to existing slopes that have small slips or slumps by filling in the failed area with plant materials and soil.

Conditions Where Practice Applies

This is an appropriate technique for repairing slip areas that do not exceed 4 feet deep or 6 feet wide. It should not be used as a slope stability measure if structural embankment support is needed.

Design Criteria

1. The live branch cuttings shall be 1/2 - 2 inches in diameter and long enough to touch the undisturbed soil at the back of the area to be repaired. They should extend 4 - 6 inches beyond the finished backfill grade.
2. Wooden posts should be used to secure the plant material in place. They should be 6 - 8 feet long and 3 - 4 inches in diameter. If lumber is used, it shall be a minimum standard two by four.
3. Wooden posts shall be driven vertically 3 feet deep and placed in a grid pattern 1 - 2 feet apart.
4. Beginning at the bottom of the slip area, 4 - 6 inch layers of live branch cuttings are placed in angled layers, 1.5 to 3 feet apart. Compacted moist soil is placed between the layers (see Figure 4.8).

Maintenance

Due to the susceptibility of plant materials to the physical constraints of the site, climate conditions, and animal populations, it is necessary to inspect installations frequently. This is especially important during the first year or two of establishment. Plant materials missing or damaged should be replaced as soon as possible. Sloughs or breaks in drainage pattern should be reestablished for the site as quickly as possible to maintain stability.

**Figure 4.8
Branchpacking**

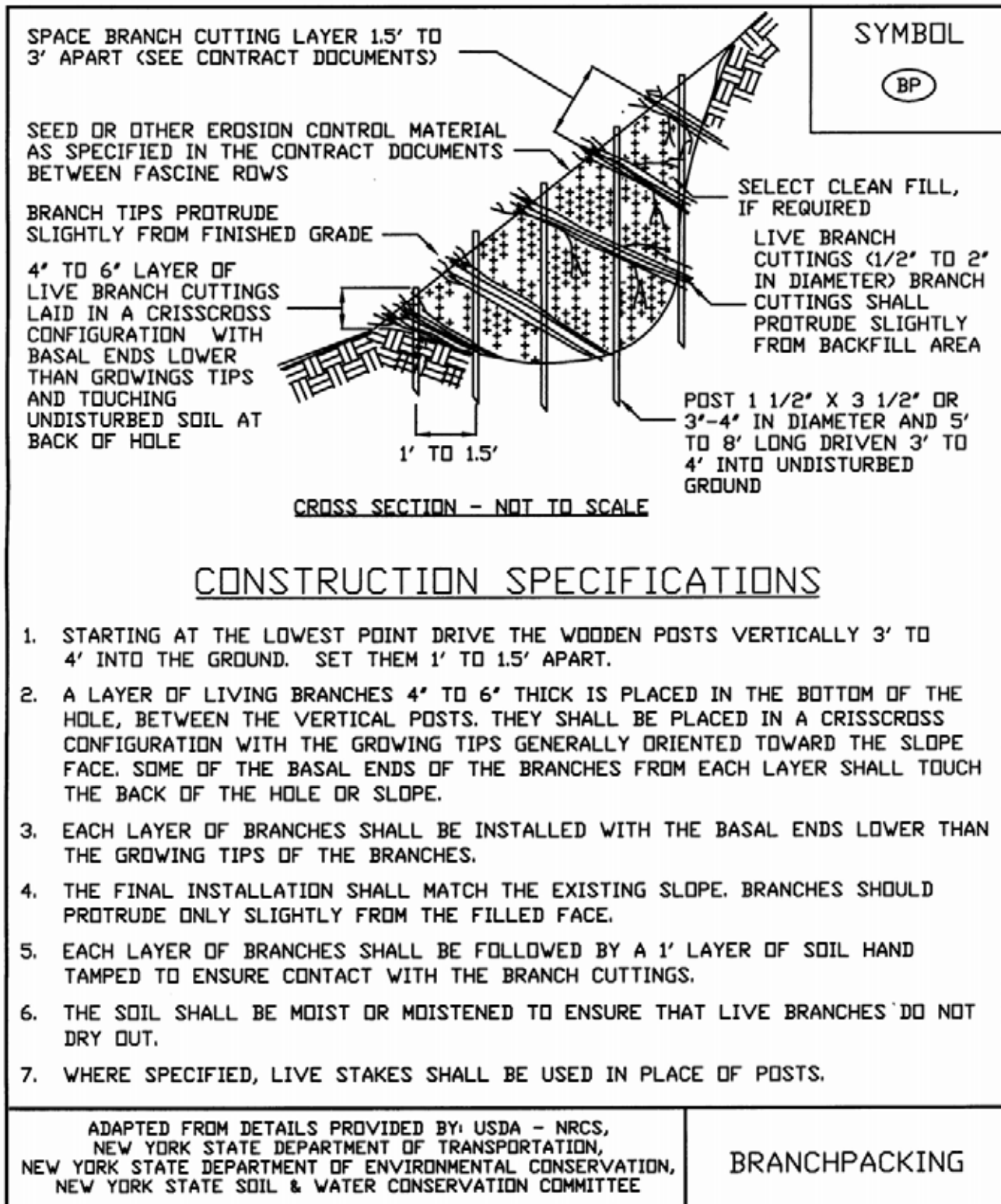

STANDARD AND SPECIFICATIONS FOR FIBER ROLL



Definition

A fiber roll is a coir (coconut fiber), straw, or excelsior woven roll encased in netting of jute, nylon, or burlap.

Purpose

To dissipate energy along streambanks, channels, and bodies of water and reduce sheet flow on slopes.

Conditions Where Practice Applies

Fiber rolls are used where the water surface levels are relatively constant. Artificially controlled streams for hydropower are not good candidates for this technique. The rolls provide a good medium for the introduction of herbaceous vegetation. Planting in the fiber roll is appropriate where the roll will remain continuously wet.

Design Criteria

1. The roll is placed in a shallow trench dug below baseflow or in a 4 inch trench on the slope contour and anchored by 2" x 2", 3-foot long posts driven on each side of the roll (see Figure 4.9).
2. The roll is contained by a 9-gauge non-galvanized wire placed over the roll from post to post. Braided nylon rope (1/8" thick) may be used.
3. The anchor posts shall be spaced laterally 4 feet on center on both sides of the roll, staggered, and driven down to the top of the roll.
4. Soil is placed behind the roll and planted with suitable herbaceous or woody vegetation. If the roll will be continuously saturated, wetland plants may be planted into voids created in the upper surface of the roll.
5. Where water levels may fall below the bottom edge of the roll, a brush layer of willow should be installed so as to lay across the top edge of the roll.

Maintenance

Due to the susceptibility of plant materials to the physical constraints of the site, climate conditions, and animal populations, it is necessary to inspect installations frequently. This is especially important during the first year or two of establishment. Plant materials missing or damaged should be replaced as soon as possible. Sloughs or breaks in drainage pattern should be reestablished for the site as quickly as possible to maintain stability.

**Figure 4.9
Fiber Roll**

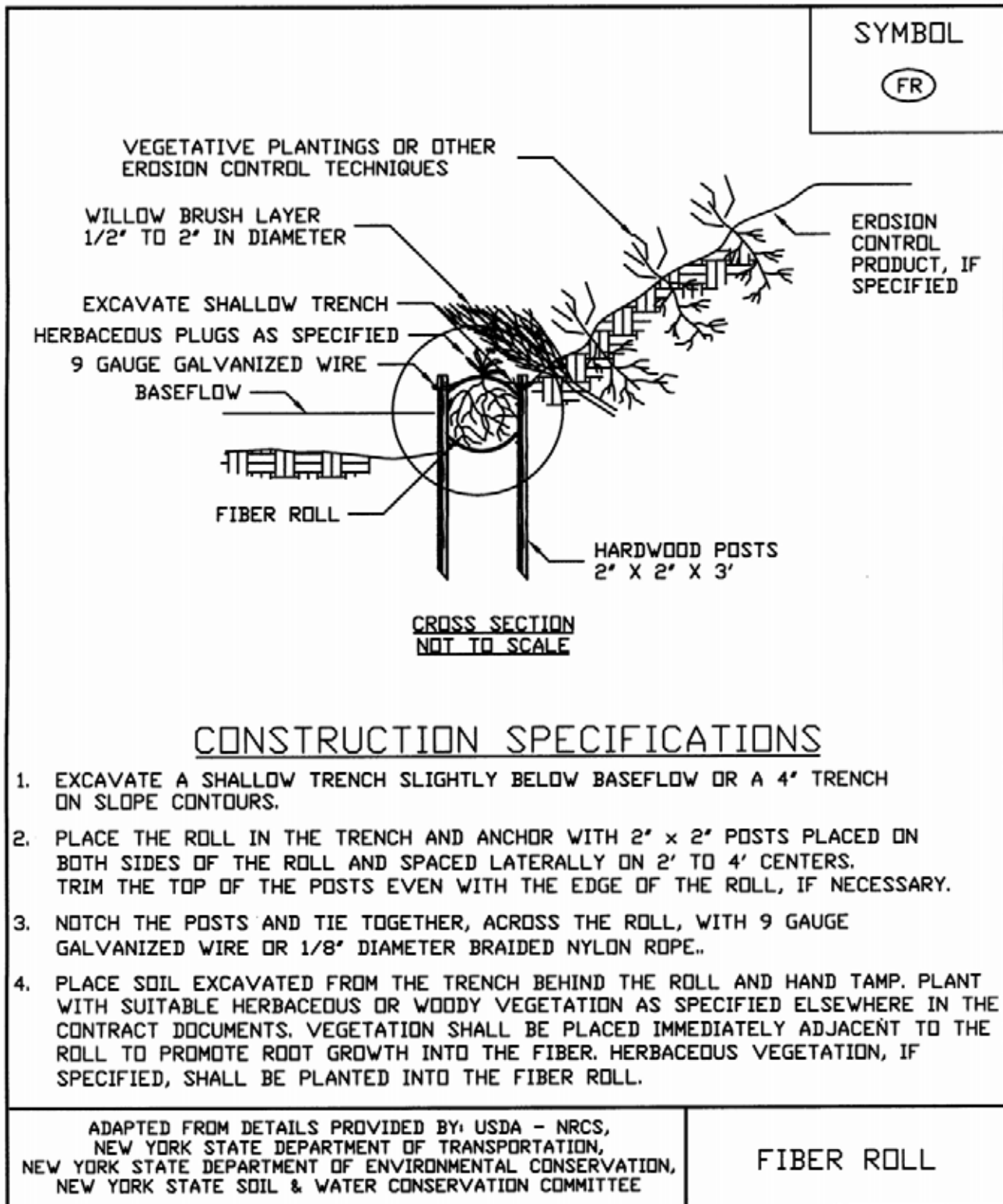

References

1. Gray, Donald H. and A.T. Leiser. 1982. Biotechnical Slope Protection and Erosion Control. Van Nostrand Reinhold Company. New York.
2. Dickerson, John A. and D.W. Lake, Jr. 1989. ASAE Paper No. 892 654. Cost Effective Biotechnical Slope Protection Trials in New York.
3. Dickerson, John A. and M. Van der Grinten. 1991. ICEA paper Biotechnical Slope Protection Systems on Dry Soils in the Northeast United States.
4. Dickerson, et. al. 1990. ICEA paper. Obtaining Plant Materials for Biotechnical Work.

Page Intentionally Left Blank

SECTION 5
STRUCTURAL MEASURES
FOR EROSION AND SEDIMENT CONTROL

CONTENTS

	<u>Page</u>
General Introduction.....	5.1
Standard Symbols.....	5.3
Section 5A.....	Structural Measures—Temporary
Section 5B.....	Structural Measures—Permanent
References	

Section prepared by:

Donald W. Lake Jr., P.E., CPESC, CPSWQ
Engineering Specialist
New York State Soil & Water Conservation Committee

STRUCTURAL MEASURES FOR EROSION AND SEDIMENT CONTROL

General

Uncontrolled runoff and excess erosion often occurs in urban developments, particularly during the construction stage. This erosion forms rills and gullies; washes out roads; scours cut and fill areas; fills road ditches, storm drains, and streams; and does other damage that is costly to the developers and damaging to land and water users below. Careful inclusion of proven conservation practices in the development plan can prevent or alleviate much of this damage and should be a part of every development plan.

These practices will usually be a combination of vegetative and structural measures. They may be temporary and serve only during the construction stage or they may be permanent in nature and become a part of the completed development. Permanent structural practices should be installed as early as possible in the construction stage. This section deals with the more common structural measures that may be used. Adequate designs, plans, and specification should be prepared for the measures to be used. A number of measures and specifications are included throughout this section. The designer shall determine those elements to be installed to control erosion (Section 2) and follow the criteria included in these standards and specifications.

Introduction

Structural erosion and sediment control practices have been classified as either temporary or permanent, according to how they are used. Temporary structural practices are used during construction to prevent offsite sedimentation. The length of time that temporary practices are functional varies from project to project, since the sediment control strategy may change as construction activity progresses. Permanent structural practices are used to convey surface water runoff to a safe outlet. Permanent structural practices will remain in place and continue to function after the completion of construction.

Regardless of whether the practices are temporary or permanent, runoff control measures should be the first items constructed when grading begins, and be completely functional before downslope land disturbance takes place. Earthen structures such as diversions, dikes, and swales should be stabilized before being considered functional. Only after the runoff control structures are operational and sediment control measures are in place, should clearing and grading on the rest of the construction site begin.

While clearing and grading the site, it is important to

minimize the amount of sediment that is produced. In general, it is advantageous to clear only as much area as is necessary to accommodate construction needs. Grade and stabilize large sites in stages whenever possible. Limiting the amount of disturbed area limits the amount of sediment that is generated, thus decreasing the amount of maintenance required on sediment control measures.

Sediment generated during the construction of cut and fill slopes can also be minimized through design and grading techniques. When designing either a cut or fill slope, factors to consider include slope length and steepness, soil type, and upslope drainage area. In general, it is important to leave soil surfaces on disturbed slopes in a roughened condition and to construct a water diversion practice at the top of slopes. Rough soil surfaces do not erode as readily as smooth soil surfaces.

Although design and grading techniques can reduce soil erosion, they cannot eliminate it entirely. Therefore, practices must be installed to prevent offsite sedimentation.

Even though the specific conditions of each site determine what measures are necessary to control erosion and sedimentation, some general principles apply to the selection and placement of sediment control measures.

1. Prevent clean water from becoming turbid, by diverting runoff from upslope areas away from disturbed areas. Earth dikes, temporary swales, perimeter dike/swales, or diversions that outlet in stable areas can be used in this capacity.
2. Remove sediment from turbid water before the water leaves the site. The method of sediment removal depends upon how the water drains from the site. Concentrated flow must be diverted to a trapping device so that suspended sediment can be deposited. Dikes or swales that outlet into traps or basins can accomplish this. A storm drain system may be used to convey concentrated sediment laden water only if the system empties into a trap or basin. Otherwise, all storm drain inlets must be protected so that sediment laden water cannot enter the drainage system before being treated to remove the sediment.
3. Surface runoff draining in sheet flow must be controlled and treated before the water leaves the site. Straw bale dikes, silt fences, or vegetative buffer strips can be used to treat sheet flow.

All practices designed and implemented must be properly maintained in order to remain functional. Sediment accumulated in basins and traps must be removed and disposed of in a manner that stabilizes them on the construction site.













Other factors should be observed during construction in order to make erosion and sediment control measures more effective in pollution control.

These are:

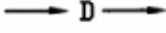

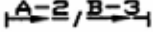



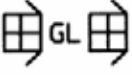



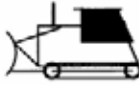

1. Sprinkle or apply dust suppressors. Keep dust down to a tolerable limit on construction sites and haul roads.
2. Use temporary bridges or culverts where fording of streams is objectionable. Avoid borrow areas where pollution from this operation is inevitable.

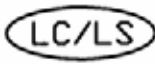
3. Protect streams from chemicals, fuel, lubricants, sewage, or other pollutants.
4. Avoid disposal of fill in floodplains or drainage ways. This reduces the capacity of these areas to pass flood flows.
5. Do not locate sanitary facilities over, or adjacent to, waterways, wells, or springs.
6. Locate storage yards and stockpiles where erosion and sediment hazards are slight. Where this is not possible, apply necessary erosion control practices.



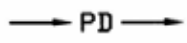

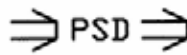









STANDARD SYMBOLS

BRANCH PACKING	
BRUSH LAYER	
BRUSH MATTRESS	
CHECK DAM	
CONSTRUCTION ROAD STABILIZATION	
CURB DROP INLET PROTECTION	
DIVERSION	
DUNE STABILIZATION	
DUST CONTROL	
EARTH DIKE	
EXCAVATED DROP INLET PROTECTION	
FIBER ROLL	
FILTER FABRIC DROP INLET PROTECTION	
GRADE STABILIZATION STRUCTURE	
GRASSED WATERWAY	
<p>ADAPTED FROM DETAILS PROVIDED BY: USDA - NRCS, NEW YORK STATE DEPARTMENT OF TRANSPORTATION, NEW YORK STATE DEPARTMENT OF ENVIRONMENTAL CONSERVATION, NEW YORK STATE SOIL & WATER CONSERVATION COMMITTEE</p>	
<p>STANDARD SYMBOLS</p>	





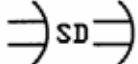



STANDARD SYMBOLS (cont'd)

LAND GRADING	
LEVEL SPREADER	
LINED WATERWAY	
LIVE CRIBWALL	
LIVE CUTTINGS/LIVE STAKES PLANTING	
LIVE FASCINE	
MULCHING	
OPTIONAL SEDIMENT TRAP DEWATERING DEVICE	
PAVED FLUME	
PERIMETER DIKE OR SWALE	
PERMANENT SEEDING	
PIPE OUTLET SEDIMENT TRAP	
PIPE SLOPE DRAIN FLEXIBLE	
PORTABLE SEDIMENT TANK	
PROTECTING VEGETATION	
ADAPTED FROM DETAILS PROVIDED BY: USDA - NRCS, NEW YORK STATE DEPARTMENT OF TRANSPORTATION, NEW YORK STATE DEPARTMENT OF ENVIRONMENTAL CONSERVATION, NEW YORK STATE SOIL & WATER CONSERVATION COMMITTEE	STANDARD SYMBOLS

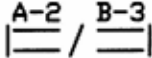
STANDARD SYMBOLS (cont'd)

RECREATION AREA IMPROVEMENT	
RIP RAP OUTLET PROTECTION	
RIP RAP SLOPE PROTECTION	
RIP RAP STREAMBANK PROTECTION	
ROCK DAM	
SEDIMENT BASIN	
SEDIMENT TRAP	
SEGMENTED RETAINING WALL	
SILT FENCE	
SODDING	
STABILIZED CONSTRUCTION ENTRANCE	
STONE & BLOCK DROP INLET PROTECTION STRUCTURE	
STRAW BALE DIKE	
SUBSURFACE DRAIN	
SUMP PIT	
ADAPTED FROM DETAILS PROVIDED BY: USDA - NRCS, NEW YORK STATE DEPARTMENT OF TRANSPORTATION, NEW YORK STATE DEPARTMENT OF ENVIRONMENTAL CONSERVATION, NEW YORK STATE SOIL & WATER CONSERVATION COMMITTEE	STANDARD SYMBOLS

STANDARD SYMBOLS (cont'd)

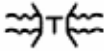
SURFACE ROUGHENING	
TEMPORARY SEEDING	
TEMPORARY SWALE	
TOPSOILING	
TREE REVETMENT	
TURBIDITY CURTAIN	
VEGETATED ROCK GABIONS	
WATER BAR	
WATERWAY CROSSING	
<div style="display: flex; justify-content: space-between; align-items: center;"> <div style="font-size: small; text-align: center;"> <p>ADAPTED FROM DETAILS PROVIDED BY: USDA - NRCS, NEW YORK STATE DEPARTMENT OF TRANSPORTATION, NEW YORK STATE DEPARTMENT OF ENVIRONMENTAL CONSERVATION, NEW YORK STATE SOIL & WATER CONSERVATION COMMITTEE</p> </div> <div style="font-size: large; font-weight: bold;">STANDARD SYMBOLS</div> </div>	

**SECTION 5A
TEMPORARY STRUCTURAL MEASURES
FOR
EROSION AND SEDIMENT CONTROL**

CONTENTS

	<u>Page</u>
Earth Dike.....	5A.1
Temporary Swale.....	5A.3
Perimeter Dike/Swale.....	5A.7
Temporary Storm Drain Diversion.....	5A.9
Water Bar.....	5A.11
Level Spreader.....	5A.13
Pipe Slope Drain.....	5A.15
Straw Bale Dike.....	5A.17
Silt Fence.....	5A.19
Check Dam.....	5A.23
Rock Dam.....	5A.25
Storm Drain Inlet Protection.....	5A.27
Turbidity Curtain.....	5A.33
Sediment Trap.....	5A.35
Portable Sediment Tank.....	5A.47
Sediment Basin.....	5A.49
Stabilized Construction Entrance.....	5A.75
Construction Road Stabilization.....	5A.77
Temporary Access Waterway Crossing.....	5A.79
Dust Control.....	5A.87
Sump Pit.....	5A.89

List of Figures

<u>Figure</u>	<u>Title</u>	<u>Page</u>
5A.1	Earth Dike Details	5A.2
5A.2	Temporary Swale Details.....	5A.5
5A.3	Perimeter Dike/Swale Details.....	5A.8
5A.4	Water Bar Details.....	5A.12
5A.5	Level Spreader Details.....	5A.14
5A.6	Pipe Slope Drain.....	5A.16
5A.7	Straw Bale Dike Details.....	5A.18
5A.8	Silt Fence Details.....	5A.21
5A.9	Check Dam Details.....	5A.24
5A.10	Rock Dam Details.....	5A.26
5A.11	Excavated Drop Inlet Protection Details.....	5A.29
5A.12	Filter Fabric Drop Inlet Protection Details.....	5A.30
5A.13	Stone and Block Drop Inlet Protection Details.....	5A.31
5A.14	Curb Drop Inlet Protection Details.....	5A.32
5A.15	Turbidity Curtain Details.....	5A.34
5A.16(1)	Pipe Outlet Sediment Trap: ST-I.....	5A.38
5A.16(2)	Pipe Outlet Sediment Trap: ST-I—Construction Specifications.....	5A.39
5A.17	Grass Outlet Sediment Trap: ST-II.....	5A.40
5A.18	Catch Basin Sediment Trap: ST-III.....	5A.41
5A.19	Stone Outlet Sediment Trap: ST-IV.....	5A.42
5A.20(1)	Riprap Outlet Sediment Trap: ST-V.....	5A.43
5A.20(2)	Riprap Outlet Sediment Trap: ST-V—Construction Specifications.....	5A.44
5A.21	Optional Sediment Trap Dewatering Devices.....	5A.45
5A.22	Portable Sediment Tank.....	5A.48
5A.23	Sediment Basin Details.....	5A.57
5A.24(1)	Sediment Basin Design Example 1.....	5A.58
5A.24(2)	Sediment Basin Design Example 2.....	5A.59
5A.25	Riser Inflow Chart.....	5A.60
5A.26	Pipe Flow Chart for “n” = 0.025.....	5A.61
5A.27	Pipe Flow Chart for “n” = 0.013.....	5A.62
5A.28	Optional Sediment Basin Dewatering Devices.....	5A.63
5A.29(1)	Concentric Trash Rack and Anti-Vortex Device.....	5A.64
5A.29(2)	Concentric Trash Rack and Anti-Vortex Device—Design Table.....	5A.65
5A.30	Riser Base Details.....	5A.66
5A.31(1)	Anti-Seep Collar Design.....	5A.67
5A.31(2)	Anti-Seep Collar Design Charts.....	5A.68
5A.32	Anti-Seep Collar Design Details.....	5A.69
5A.33(1)	Design Data for Earth Spillways	5A.70
5A.33(2)	Design Table for Vegetated Spillways Excavated in Erosion Resistant Soils.....	5A.71
5A.33(3)	Design Table for Vegetated Spillways Excavated in Very Erodible Soils.....	5A.72
5A.34	Sediment Basin Baffle Details.....	5A.74
5A.35	Stabilized Construction Entrance Details.....	5A.76
5A.36	Temporary Access Bridge.....	5A.84
5A.37	Temporary Access Culvert.....	5A.85
5A.38	Temporary Access Ford.....	5A.86
5A.39	Sump Pit Details.....	5A.90

STANDARD AND SPECIFICATIONS FOR EARTH DIKE



For drainage areas larger than 10 acres, refer to the Standard and Specifications for Diversion on page 5B.1.

Stabilization

Stabilization of the dike shall be completed within 7 days of installation in accordance with the standard and specifications for seed and straw mulch or straw mulch only if not in seeding season and flow channel shall be stabilized as per the following criteria:

Type of Treatment	Channel Grade ¹	Flow Channel	
		A (<5 Ac.)	B (5-10 Ac)
1	0.5-3.0%	Seed & Straw Mulch	Seed & Straw Mulch
2	3.1-5.0%	Seed & Straw Mulch	Seed and cover with RECP, sod, or lined with plastic or 2 in. stone
3	5.1-8.0%	Seed and cover with RECP, Sod, or line with plastic or 2 in. stone	Line with 4-8 in. stone or, Recycled Concrete Equivalent ² or geotextile
4	8.1-20%	Line with 4-8 in. stone or Recycled Concrete Equivalent ² or geotextile	Site Specific Engineering Design

Definition

A temporary berm or ridge of compacted soil, located in such a manner as to channel water to a desired location.

Purpose

The purpose of an earth dike is to direct runoff to a sediment trapping device, thereby reducing the potential for erosion and off site sedimentation. Earth dikes can also be used for diverting clean water away from disturbed areas.

Conditions Where Practice Applies

Earth dikes are often constructed across disturbed areas and around construction sites such as graded parking lots and subdivisions. The dikes shall remain in place until the disturbed areas are permanently stabilized.

Design Criteria

See Figure 5A.1 on page 5A.2 for details.

General

	Dike A	Dike B
Drainage Area	<5 Ac	5-10 Ac
Dike Height	18 in.	36 in.
Dike Width	24 in.	36 in.
Flow Width	4 ft.	6 ft.
Flow Depth in Channel	8 in.	15 in.
Side Slopes	2:1 or flatter	2:1 or flatter
Grade	0.5% Min. 20% Max.	0.5% Min. 20% Max.

¹ In highly erodible soils, as defined by the local approving agency, refer to the next higher slope grade for type of stabilization.

² Recycled Concrete Equivalent shall be concrete broken into the required size, and shall contain no steel reinforcement.

Outlet

Earth dikes shall have an outlet that functions with a minimum of erosion.

Runoff shall be conveyed to a sediment trapping device until the drainage area above the dike is adequately stabilized.

The on-site location may need to be adjusted to meet field conditions in order to utilize the most suitable outlet.

**Figure 5A.1
Earth Dike**

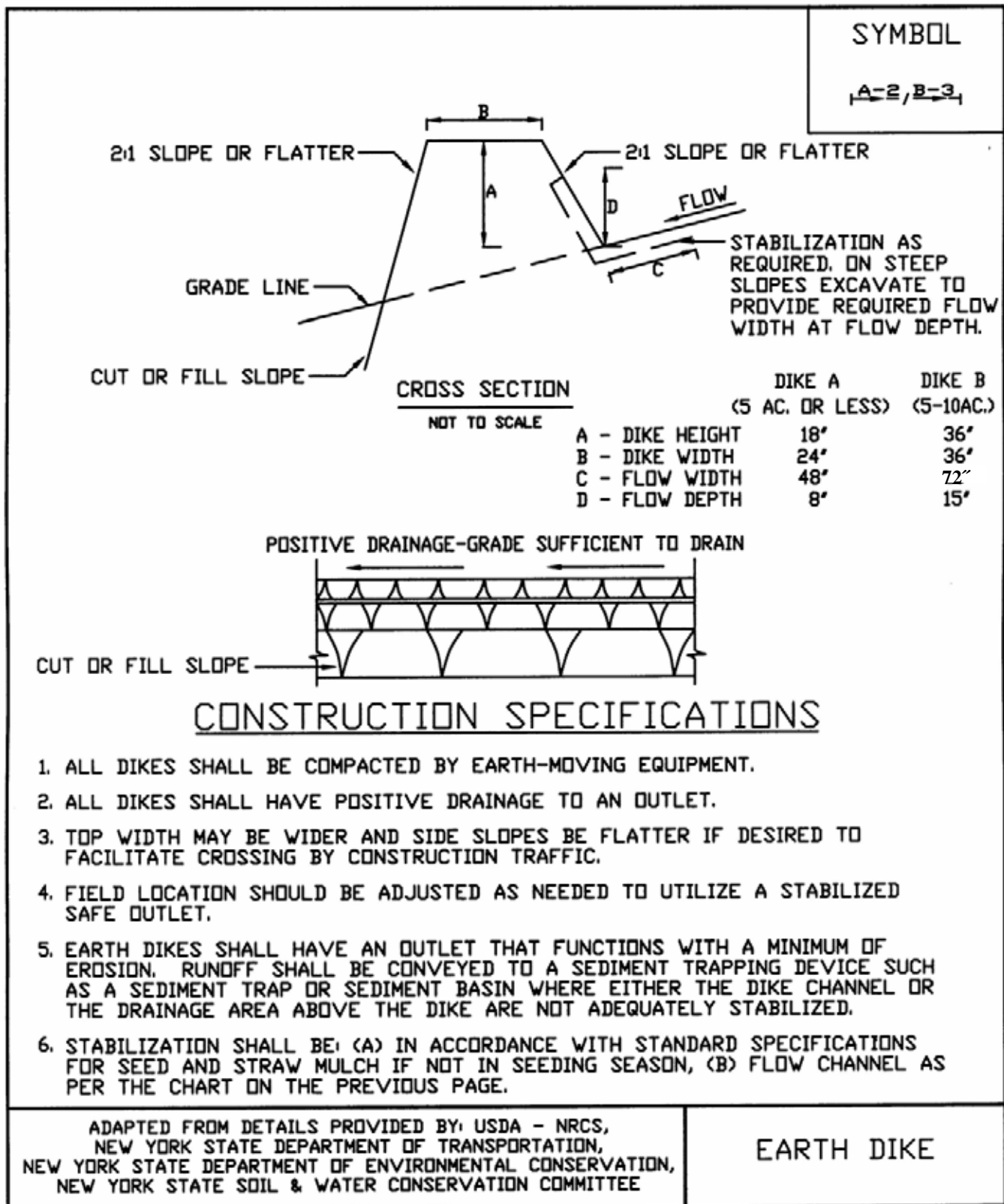

STANDARD AND SPECIFICATIONS FOR TEMPORARY SWALE



	<u>Swale A</u>	<u>Swale B</u>
Drainage Area	<5 Ac	5-10 Ac
Bottom Width of Flow Channel	4 ft	6 ft
Depth of Flow Channel	1 ft	1 ft
Side Slopes	2:1 or flatter	2:1 or flatter
Grade	0.5% Min. 20% Max.	0.5% Min. 20% Max.

For drainage areas larger than 10 acres, refer to the Standard and Specification for Waterways on page 5B.11.

Stabilization

Stabilization of the swale shall be completed within 7 days of installation in accordance with the appropriate standard and specifications for vegetative stabilization or stabilization with mulch as determined by the time of year. The flow channel shall be stabilized as per the following criteria:

Type of <u>Treatment</u>	Channel <u>Grade</u> ¹	<u>Flow Channel</u>	
		<u>A (<5 Ac.)</u>	<u>B (5-10 Ac)</u>
1	0.5-3.0%	Seed & Straw Mulch	Seed & Straw Mulch
2	3.1-5.0%	Seed & Straw Mulch	Seed and cover with RECP, Sod, or lined with plastic or 2 in. stone
3	5.1-8.0%	Seed and cover with RECP, Sod, or line with plastic or 2 in. stone	Line with 4-8 in. or stone or Recycled Concrete Equivalent ² or geotextile
4	8.1-20%	Line with 4-8 in. stone or Recycled Concrete Equivalent ² or geotextile	Site Specific Engineering Design

Definition

A temporary excavated drainage way.

Purpose

The purpose of a temporary swale is to prevent runoff from entering disturbed areas by intercepting and diverting it to a stabilized outlet or to intercept sediment laden water and divert it to a sediment trapping device.

Conditions Where Practice Applies

Temporary swales are constructed:

1. to divert flows from entering a disturbed area.
2. intermittently across disturbed areas to shorten overland flow distances.
3. to direct sediment laden water along the base of slopes to a trapping device.
4. to transport offsite flows across disturbed areas such as rights-of-way.

Swales collecting runoff from disturbed areas shall remain in place until the disturbed areas are permanently stabilized.

Design Criteria

See Figure 5A.2 on page 5A.5 for details.

¹ In highly erodible soils, as defined by the local approving agency, refer to the next higher slope grade for type of stabilization.

² Recycled Concrete Equivalent shall be concrete broken into the required size, and shall contain no steel reinforcement.

Outlet

Swale shall have an outlet that functions with a minimum of erosion, and dissipates runoff velocity prior to discharge off the site.

Runoff shall be conveyed to a sediment trapping device such as a sediment trap or sediment basin until the drainage area above the swale is adequately stabilized.

The on-site location may need to be adjusted to meet field conditions in order to utilize the most suitable outlet condition.

If a swale is used to divert clean water flows from entering a disturbed area, a sediment trapping device may not be needed.

**Figure 5A.2
Temporary Swale**

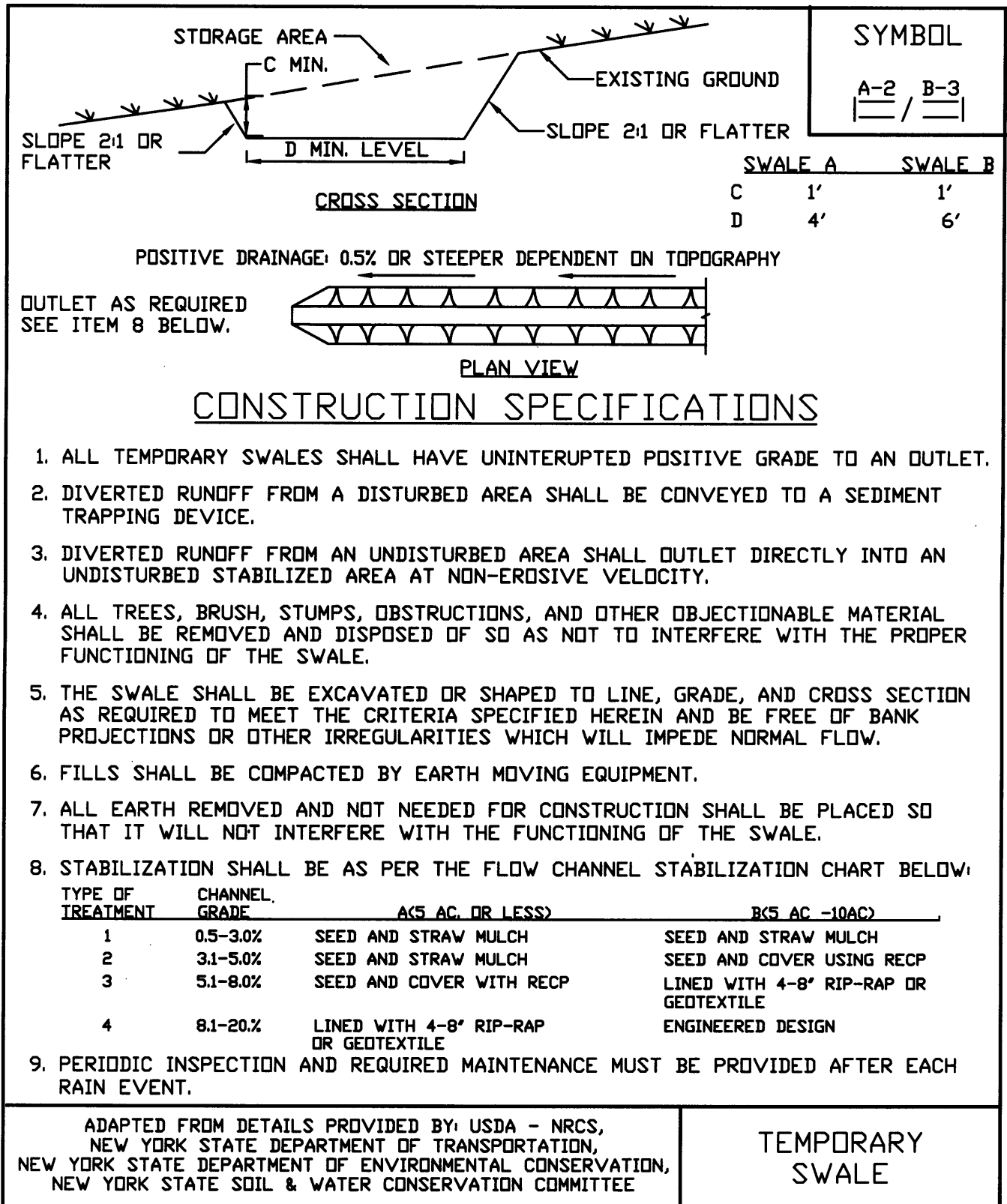

STANDARD AND SPECIFICATIONS FOR PERIMETER DIKE/SWALE



Definition

A temporary ridge of soil excavated from an adjoining swale located along the perimeter of the site or disturbed area.

Purpose

The purpose of a perimeter dike/swale is to prevent off site storm runoff from entering a disturbed area and to prevent sediment laden storm runoff from leaving the construction site or disturbed area.

Conditions Where Practice Applies

Perimeter dike/swale is constructed to divert flows from entering a disturbed area, or along tops of slopes to prevent flows from eroding the slope, or along base of slopes to direct sediment laden flows to a trapping device.

The perimeter dike/swale shall remain in place until the disturbed areas are permanently stabilized.

Design Criteria

See Figure 5A.3 on page 5A.8 for details.

The perimeter dike/swale shall not be constructed outside the property lines without obtaining legal easements from affected adjacent property owners. A design is not required for perimeter dike/swale. The following criteria shall be used:

Drainage area – Less than 2 acres (for drainage areas larger than 2 acres but less than 10 acres, see earth dike or temporary swale; for drainage areas larger than 10 acres, see standard and specifications for diversion).

Height – 18 inches minimum from bottom of swale to top of dike evenly divided between dike height and swale depth.

Bottom width of dike – 2 feet minimum.

Width of swale – 2 feet minimum.

Grade – Dependent upon topography, but shall have positive drainage (sufficient grade to drain) to an adequate outlet. Maximum allowable grade not to exceed 8 percent.

Stabilization – The disturbed area of the dike and swale shall be stabilized within 7 days of installation, in accordance with the standard and specifications for temporary swales.

Outlet

1. Perimeter dike/swale shall have a stabilized outlet.
2. Diverted runoff from a protected or stabilized upland area shall outlet directly onto an undisturbed stabilized area.
3. Diverted runoff from a disturbed or exposed upland area shall be conveyed to a sediment trapping device such as a sediment trap, sediment basin, or to an area protected by any of these practices.
4. The on-site location may need to be adjusted to meet field conditions in order to utilize the most suitable outlet.

Figure 5A.3
Perimeter Dike/Swale

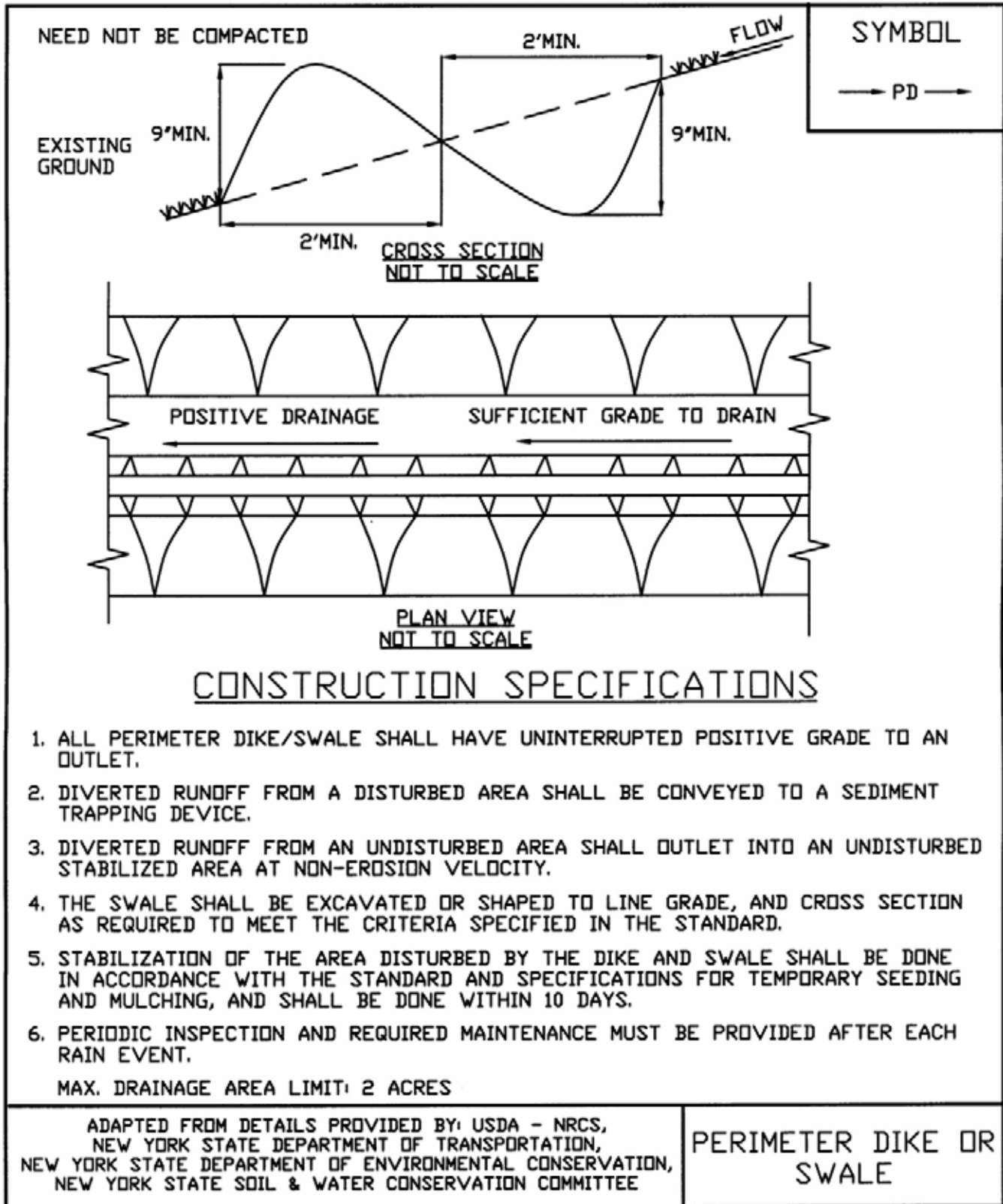

STANDARD AND SPECIFICATIONS FOR TEMPORARY STORM DRAIN DIVERSION



Definition

The redirection of a storm drain line or outfall channel so that it may temporarily discharge into a sediment trapping device.

Purpose

To prevent sediment laden water from entering a watercourse, public or private property through a storm drain system, or to temporarily provide underground conveyance of sediment laden water to a sediment trapping device.

Conditions Where Practice Applies

One of the following practices or procedures shall be used whenever the off-site drainage area is less than 50 percent of the on-site drainage area to that system. A special exception may be given, at the discretion of the local plan approval agency, where site conditions make this procedure impossible.

Method of Temporary Diversion

1. Construction of a sediment trap or basin below a permanent storm drain outfall. Temporarily diverts storm flow into the basin or trap constructed below permanent outfall channel.
2. In-line diversion of storm drain at an inlet or manhole, achieved by installing a pipe stub in the side of a manhole or inlet and temporarily blocking the permanent outfall pipe from that structure. A temporary outfall ditch or pipe may be used to convey

storm flow from the stub to a sediment trap or basin. This method may be used just above a permanent outfall or prior to connecting into an existing storm drain system.

3. Delay completion of the permanent storm drain outfall and temporarily divert storm flow into a sediment basin or trap. Earth dike, swale or design diversion is used, depending on the drainage area, to direct flow into a sediment basin or trap. The basin or trap should be constructed to one side of the proposed permanent storm drain location whenever possible.

4. Installation of a stormwater management basin early in the construction sequence. Install temporary measures to allow use as a sediment basin. Since these structures are designed to receive storm drain outfalls, diversion should not be necessary.

Completion and Disposition

When the areas contributing sediment to the system have been stabilized, procedures can be taken to restore the system to its planned use.

The following removal and restoration procedure is recommended:

1. Flush the storm drain system to remove any accumulated sediment.
2. Remove the sediment control devices, such as traps, basins, dikes, swales, etc.
3. For sites where an inlet was modified, brick shut the temporary pipe stub and open the permanent outfall pipe.
4. Establish permanent stabilized outfall channel as noted on the plans.
5. Restore the area to grades shown on the plan and stabilize with vegetative measures.
6. For basins that will be converted to stormwater management, remove the accumulated sediment, open the low flow orifice, and seed all disturbed areas to permanent vegetation.

STANDARD AND SPECIFICATIONS FOR WATER BAR



Definition

A ridge or ridge and channel constructed diagonally across a sloping road or utility right-of-way that is subject to erosion.

Purpose

To limit the accumulation of erosive velocity of water by diverting surface runoff at pre-designed intervals.

Conditions Where Practice Applies

Where runoff protection is needed to prevent erosion on sloping access right-of-ways or either long, narrow sloping areas generally less than 100 feet in width.

Design Criteria

Design computations are not required.

1. The design height shall be minimum of 12 inches measured from channel bottom to ridge top.
2. The side slopes shall be 2:1 or flatter, a minimum of 4:1 where vehicles cross.
3. The base width of the ridge shall be six feet minimum.
4. The spacing of the water bars shall be as follows:

<u>Slope (%)</u>	<u>Spacing (ft)</u>
<5	125
5 TO 10	100
10 TO 20	75
20 TO 35	50
>35	25

5. The positive grade of the water bar shall not exceed 2%. A crossing angle of approximately 60 degrees is preferred.
6. Once diverted, water must be conveyed to a stable system (i.e. vegetated swale or storm sewer system). Water bars should have stable outlets, either natural or constructed. Site spacing may need to be adjusted for field conditions to use the most suitable areas for water disposal.

See Figure 5A.4 for details.

Figure 5A.4
Water Bar

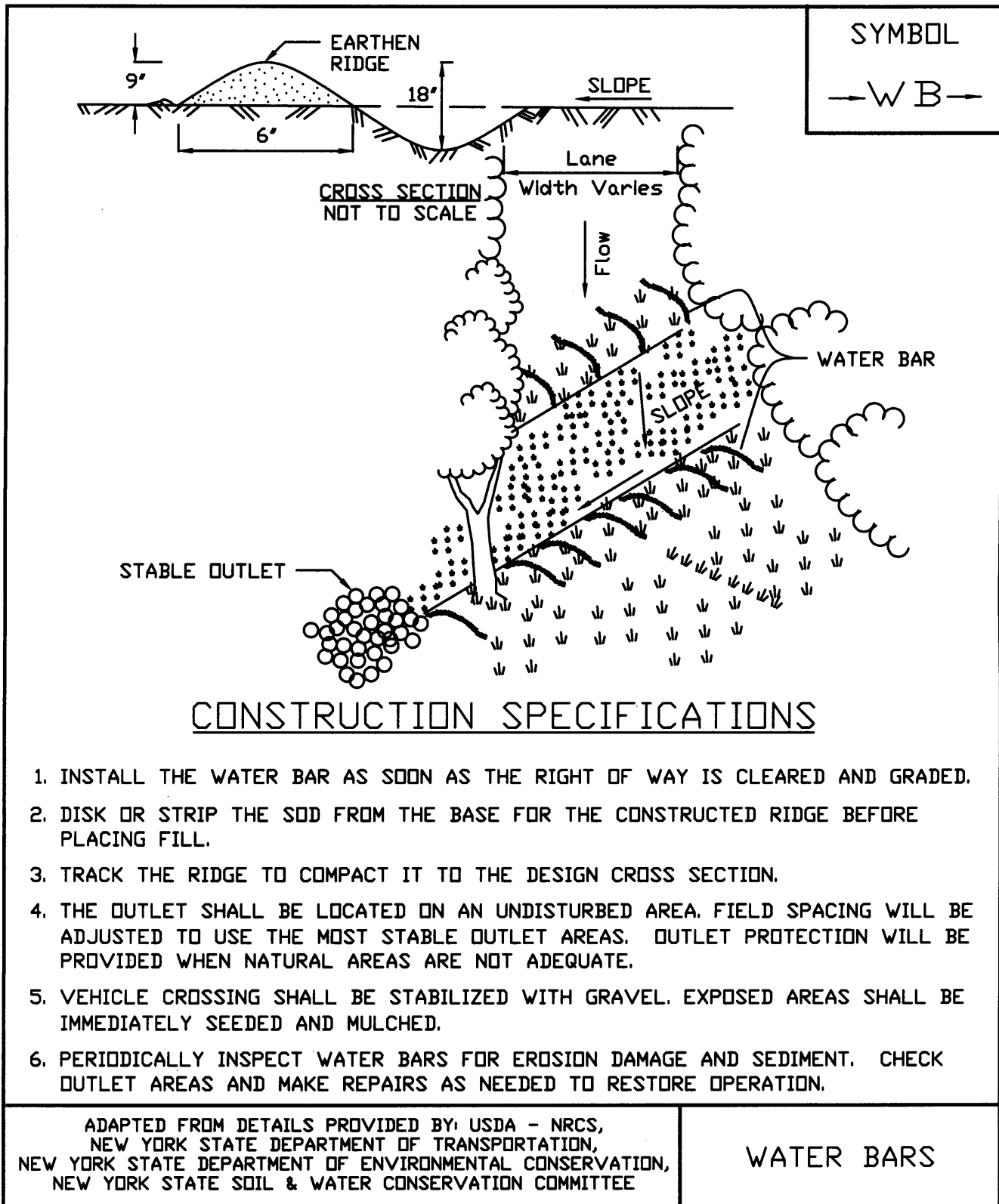

STANDARD AND SPECIFICATIONS FOR LEVEL SPREADER



Design Criteria

The design capacity shall be determined by estimating the peak flow from the 10-year storm. The drainage area shall be restricted to limit the maximum flows into the spreader to 30 cfs. The level spreader shall have the following minimum dimension:

Design Flow (cfs)	Minimum		End	
	Entrance Width (ft.)	Depth (ft.)	Width (ft.)	Length (ft.)
0-10	10	0.5	3	10
10-20	16	0.6	3	20
20-30	24	0.7	3	30

Definition

A temporary non-erosive outlet for concentrated runoff, constructed to disperse flow uniformly across a slope.

Purpose

To convert concentrated flow to sheet flow and release it uniformly over a stabilized area.

Conditions Where Practice Applies

Where sediment-free storm runoff can be released in sheet flow down a stabilized slope without causing erosion; where a level lip can be constructed without filling; where the area below the level lip is uniform with a slope of 10% or less and the runoff will not re-concentrate after release; and where no traffic will be allowed over spreader.

A transition section 20 feet in length shall be constructed from the width of the diversion or channel to the width of the spreader to ensure uniform outflow. This last transition section will blend the diversion grade to zero grade at the beginning of the spreader.

Construct the level lip in undisturbed soil to a uniform height and zeros grade over the length of the spreader. Protect the lip with an erosion resistant material or mat to prevent erosion and allow vegetation to become established.

The outlet area should be a generally smooth, well-vegetated areas no steeper than 10 percent.

See Figure 5A.5 on page 5A.14 for details.

**Figure 5A.5
Level Spreader**

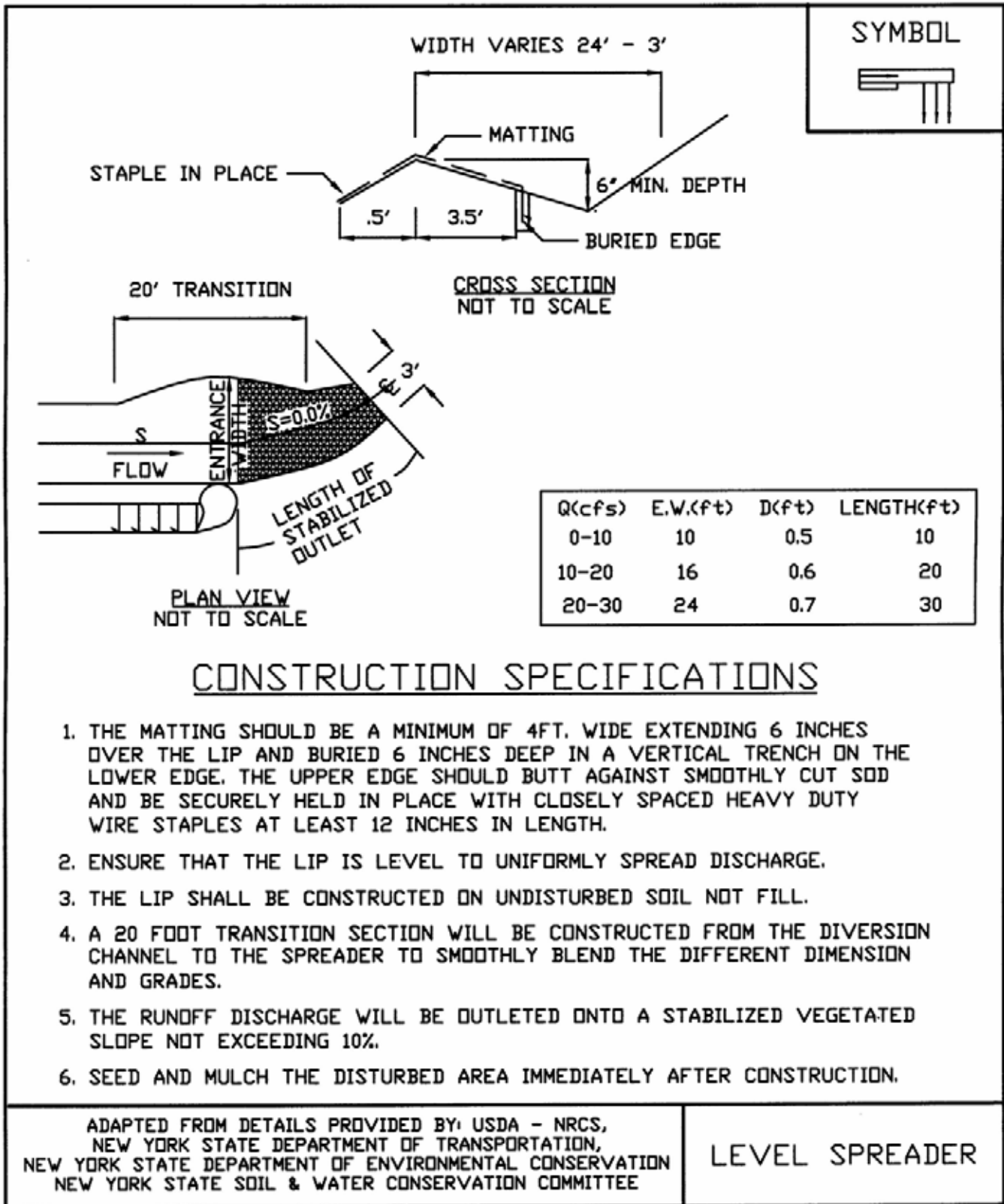

STANDARD AND SPECIFICATIONS FOR PIPE SLOPE DRAIN



Definition

A temporary structure placed from the top of a slope to the bottom of a slope.

Purpose

The purpose of the structure is to convey surface runoff down slopes without causing erosion.

Conditions Where Practice Applies

Pipe slope drains are used where concentrated flow of surface runoff must be conveyed down a slope in order to prevent erosion. The maximum allowable drainage area shall be 3.5 acres.

Design Criteria

See Figures 5A.6 on page 5A.16 for details.

General

Size	Pipe/Tubing Diameter (in.)	Maximum Drainage Area (Ac)
PSD-12	12	0.5
PSD-18	18	1.5
PSD-21	21	2.5
PSD-24	24	3.5

Inlet

The minimum height of the earth dike at the entrance to the pipe slope drain shall be the diameter of the pipe (D) plus 12 inches.

Outlet

The pipe slope drain shall outlet into a sediment trapping device when the drainage area is disturbed. A riprap apron shall be installed below the pipe outlet where water is being discharged into a stabilized area.

Construction Specifications

1. The pipe slope drain shall have a slope of 3 percent or steeper.
2. The top of the earth dike over the inlet pipe, and those dikes carrying water to the pipe, shall be at least one (1) foot higher at all points than the top of the inlet pipe.
3. Corrugated plastic pipe or equivalent shall be used with watertight connecting bands.
4. A flared end section shall be attached to the inlet end of pipe with a watertight connection.
5. The soil around and under the pipe and end section shall be hand tamped in 4 in. lifts to the top of the earth dike.
6. Where flexible tubing is used, it shall be the same diameter as the inlet pipe and shall be constructed of a durable material with hold down grommets spaced 10 ft. on centers.
7. The flexible tubing shall be securely fastened to the corrugated plastic pipe with metal strapping or watertight connecting collars.
8. The flexible tubing shall be securely anchored to the slope by staking at the grommets provided.
9. Where a pipe slope drain outlets into a sediment trapping device, it shall discharge at the riser crest or weir elevation.
10. A riprap apron shall be used below the pipe outlet where clean water is being discharged into a stabilized area. See Figure 7A.6.
11. Inspection and any needed maintenance shall be performed after each storm.

**Figure 5A.6
Pipe Slope Drain**

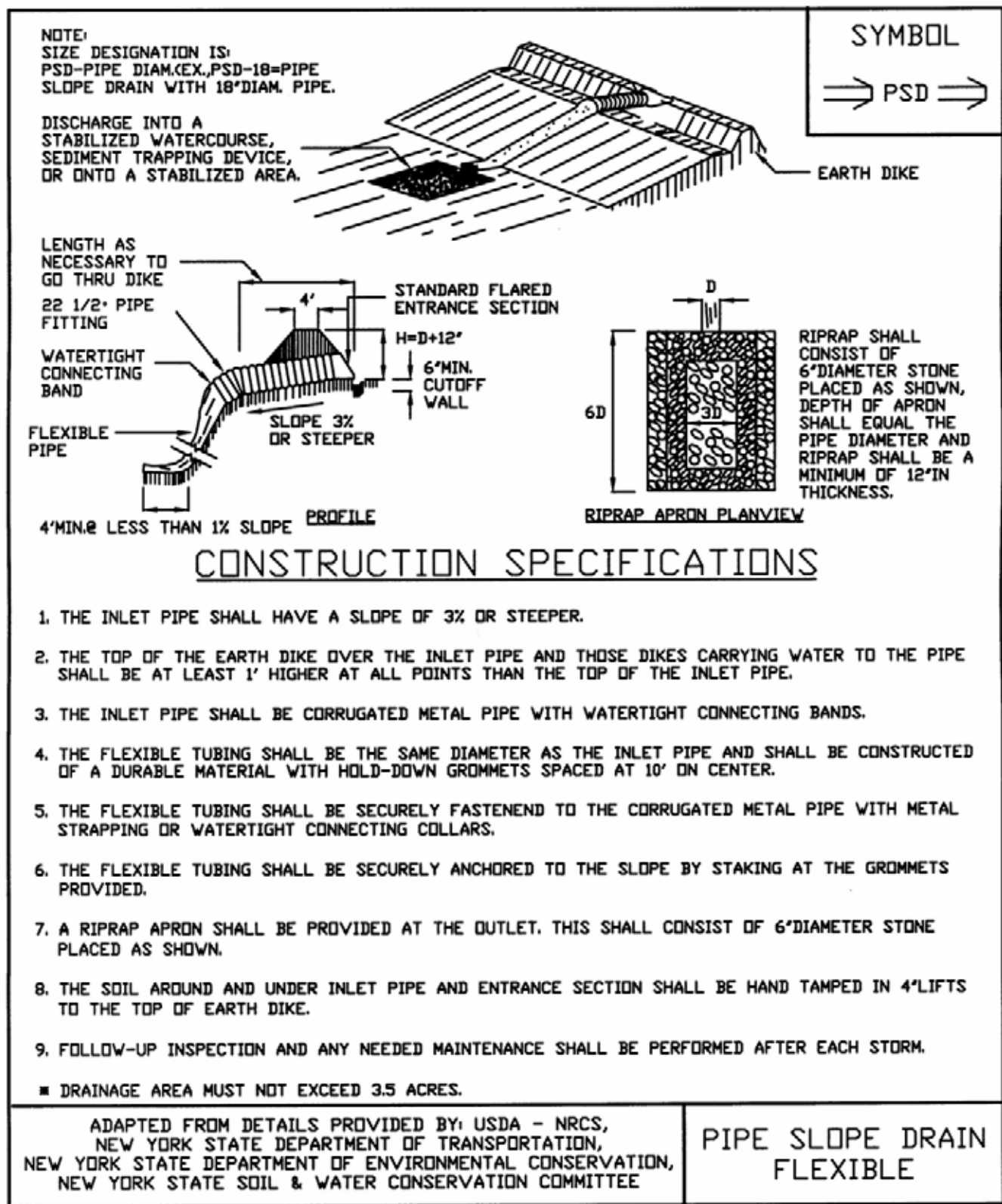

STANDARD AND SPECIFICATIONS FOR STRAW BALE DIKE



Definition

A temporary barrier of straw, or similar material, used to intercept sediment laden runoff from small drainage areas of disturbed soil.

Purpose

The purpose of a bale dike is to reduce runoff velocity and effect deposition of the transported sediment load. Straw bale dikes have an estimated design life of three (3) months.

Conditions Where Practice Applies

The straw bale dike is used where:

1. No other practice is feasible.

2. There is no concentration of water in a channel or other drainage way above the barrier.
3. Erosion would occur in the form of sheet erosion.
4. Length of slope above the straw bale dike does not exceed these limits.

Constructed Slope	Percent Slope	Slope Length (ft.)
2:1	50	25
3:1	33	50
4:1	25	75

Where slope gradient changes through the drainage area, steepness refers to the steepest slope section contributing to the straw bale dike.

The practice may also be used for a single family lot if the slope is less than 15 percent. The contributing drainage areas in this instance shall be less than one quarter of an acre per 100 feet of fence and the length of slope above the dike shall be less than 200 feet.

Design Criteria

The above table is adequate, in general, for a one-inch rainfall event. Larger storms could cause failure of this practice. Use of this practice in sensitive areas for longer than one month should be specifically designed to store expected runoff. All bales shall be placed on the contour with cut edge of bale adhering to the ground. See Figure 5A.7 on page 5A.18 or details.

**Figure 5A.7
Straw Bale Dike**

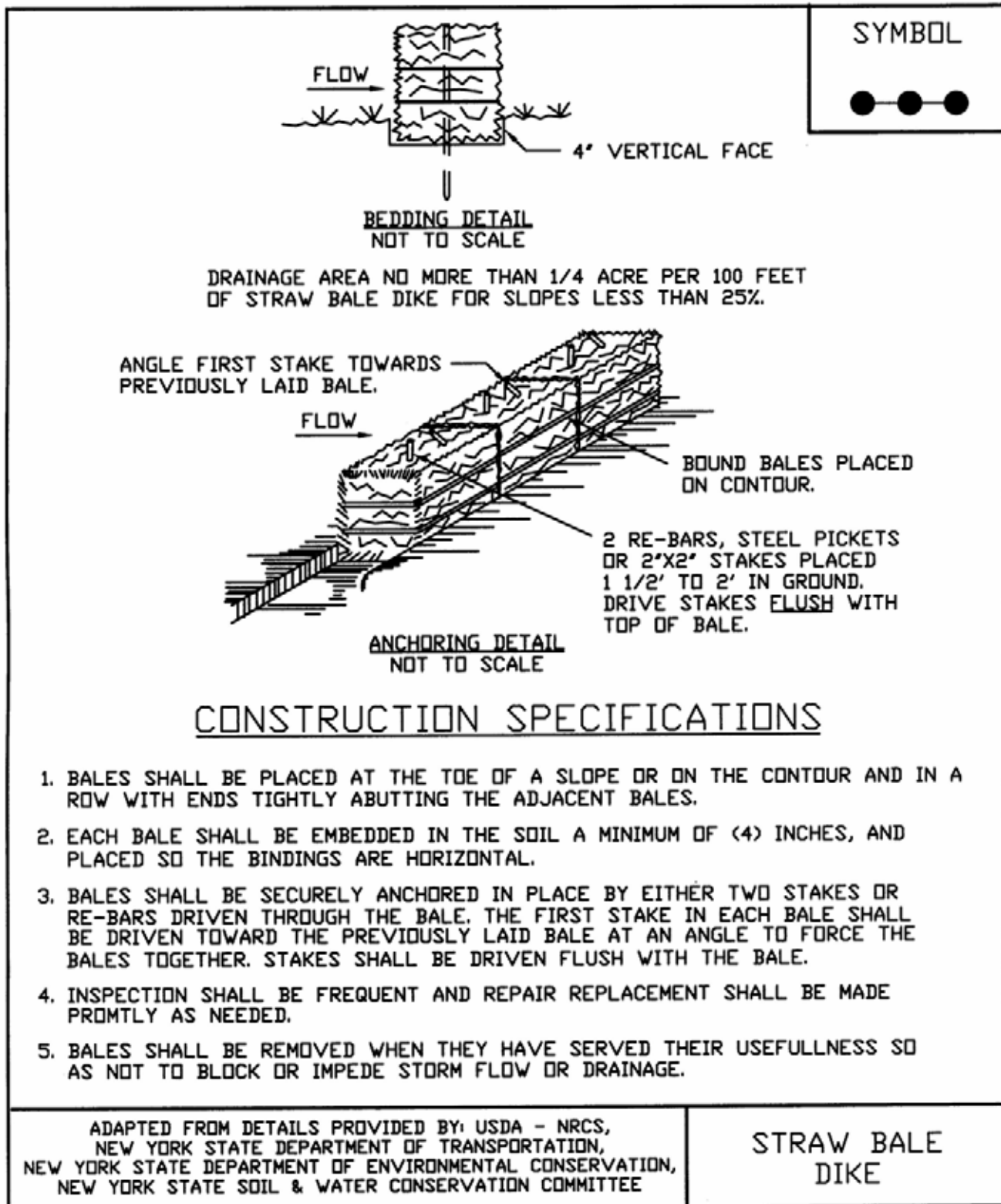

STANDARD AND SPECIFICATIONS FOR SILT FENCE



Definition

A temporary barrier of geotextile fabric installed on the contours across a slope used to intercept sediment laden runoff from small drainage areas of disturbed soil.

Purpose

The purpose of a silt fence is to reduce runoff velocity and effect deposition of transported sediment load. Limits imposed by ultraviolet stability of the fabric will dictate the maximum period the silt fence may be used (approximately one year).

Conditions Where Practice Applies

A silt fence may be used subject to the following conditions:

1. Maximum allowable slope lengths contributing runoff to a silt fence placed on a slope are:

Slope Steepness	Maximum Length (ft.)
2:1	25
3:1	50
4:1	75
5:1 or flatter	100

2. Maximum drainage area for overland flow to a silt fence shall not exceed ¼ acre per 100 feet of fence, with maximum ponding depth of 1.5 feet behind the fence; and
3. Erosion would occur in the form of sheet erosion; and
4. There is no concentration of water flowing to the barrier.

Design Criteria

Design computations are not required for installations of 1 month or less. Longer installation periods should be designed for expected runoff. All silt fences shall be placed as close to the areas as possible, but at least 10 feet from the toe of a slope to allow for maintenance and roll down. The area beyond the fence must be undisturbed or stabilized.

Sensitive areas to be protected by silt fence may need to be reinforced by using heavy wire fencing for added support to prevent collapse.

Where ends of filter cloth come together, they shall be overlapped, folded and stapled to prevent sediment bypass. A detail of the silt fence shall be shown on the plan. See Figure 5A.8 on page 5A.21 for details.

Criteria for Silt Fence Materials

1. Silt Fence Fabric: The fabric shall meet the following specifications unless otherwise approved by the appropriate erosion and sediment control plan approval authority. Such approval shall not constitute statewide acceptance.

Fabric Properties	Minimum Acceptable Value	Test Method
Grab Tensile Strength (lbs)	90	ASTM D1682
Elongation at Failure (%)	50	ASTM D1682

Mullen Burst Strength (PSI)	190	ASTM D3786
Puncture Strength (lbs)	40	ASTM D751 (modified)
Slurry Flow Rate (gal/min/sf)	0.3	
Equivalent Opening Size	40-80	US Std Sieve CW-02215
Ultraviolet Radiation Stability (%)	90	ASTM G-26

2. Fence Posts (for fabricated units): The length shall be a minimum of 36 inches long. Wood posts will be of sound quality hardwood with a minimum cross sectional area of 3.0 square inches. Steel posts will be standard T and U section weighing not less than 1.00 pound per linear foot.

3. Wire Fence (for fabricated units): Wire fencing shall be a minimum 14 gage with a maximum 6 in. mesh opening, or as approved.

4. Prefabricated Units: Envirofence, Geofab, or approved equal, may be used in lieu of the above method providing the unit is installed per details shown in Figure 5A.8.

Figure 5A.8
Silt Fence

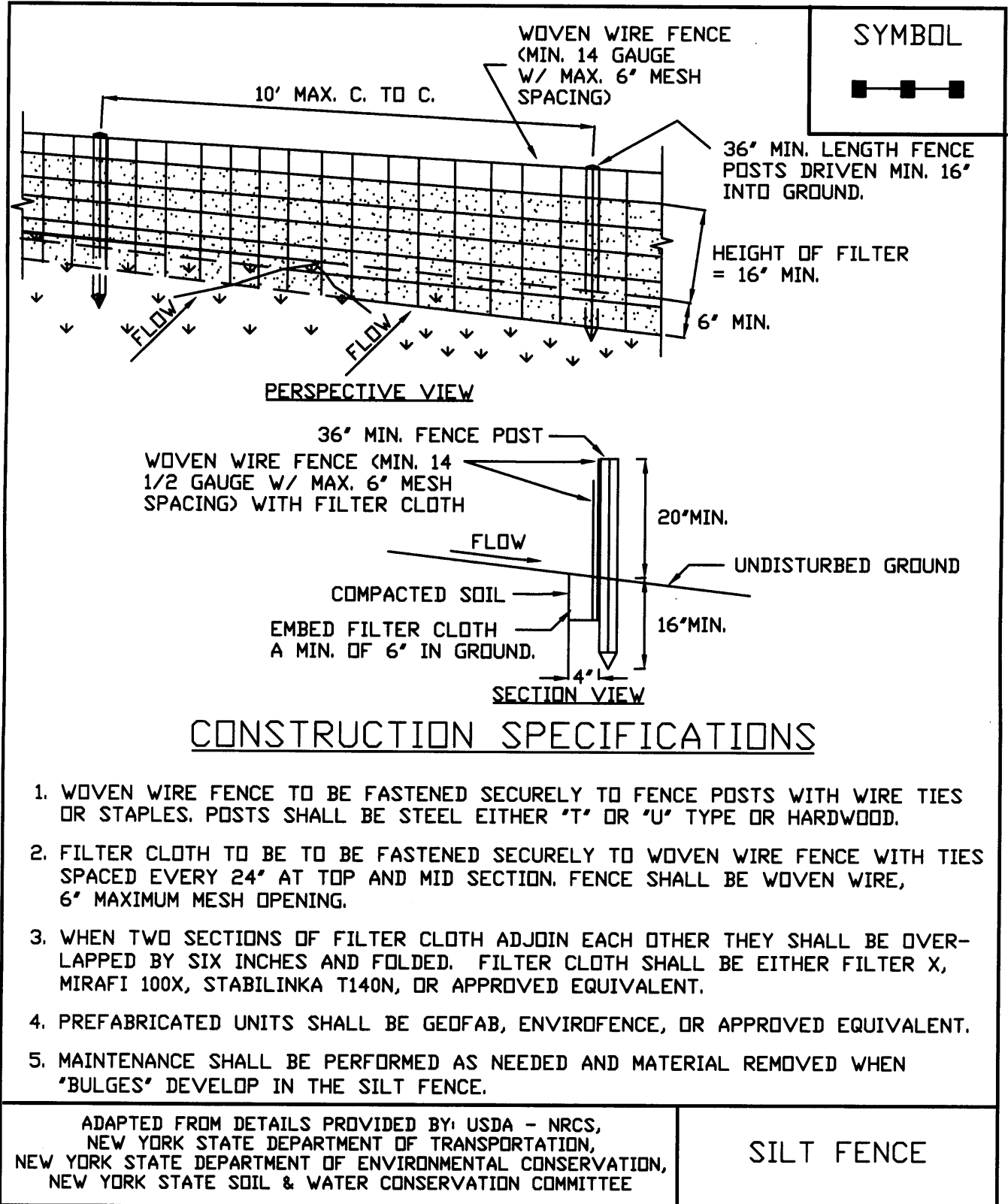

STANDARD AND SPECIFICATIONS FOR CHECK DAM



Definition

Small barriers or dams constructed of stone, bagged sand or gravel, or other durable material across a drainage way.

Purpose

To reduce erosion in a drainage channel by restricting the velocity of flow in the channel.

Condition Where Practice Applies

This practice is used as a temporary or emergency measure to limit erosion by reducing velocities in small open channels that are degrading or subject to erosion and where permanent stabilization is impractical due to short period of usefulness and time constraints of construction.

Design Criteria

Drainage Area: Maximum drainage area above the check dam shall not exceed two (2) acres.

Height: Not greater than 2 feet. Center shall be maintained 9 inches lower than abutments at natural ground elevation.

Side Slopes: Shall be 2:1 or flatter.

Spacing: The check dams shall be spaced as necessary in the channel so that the crest of the downstream dam is at the

elevation of the toe of the upstream dam. This spacing is equal to the height of the check dam divided by the channel slope.

Therefore:

$$S = h/s$$

Where:

S = spacing interval (ft.)

h = height of check dam (ft.)

s = channel slope (ft./ft.)

Example:

For a channel with a 4% slope and 2 ft. high stone check dams, they are spaced as follows:

$$S = \frac{2 \text{ ft.}}{.04 \text{ ft./ft.}} = 50 \text{ ft.}$$

Stone size: Use a well graded stone matrix 2 to 9 inches in size (NYS – DOT Light Stone Fill meets these requirements).

The overflow of the check dams will be stabilized to resist erosion that might be caused by the check dam. See Figure 5A.9 on page 5A.24 for details.

Check dams should be anchored in the channel by a cutoff trench 1.5 ft. wide and 0.5 ft. deep and lined with filter fabric to prevent soil migration.

Maintenance

The check dams should be inspected after each runoff event. Correct all damage immediately. If significant erosion has occurred between structures, a liner of stone or other suitable material should be installed in that portion of the channel.

Remove sediment accumulated behind the dam as needed to allow channel to drain through the stone check dam and prevent large flows from carrying sediment over the dam. Replace stones as needed to maintain the design cross section of the structures.

Figure 5A.9 Check Dam

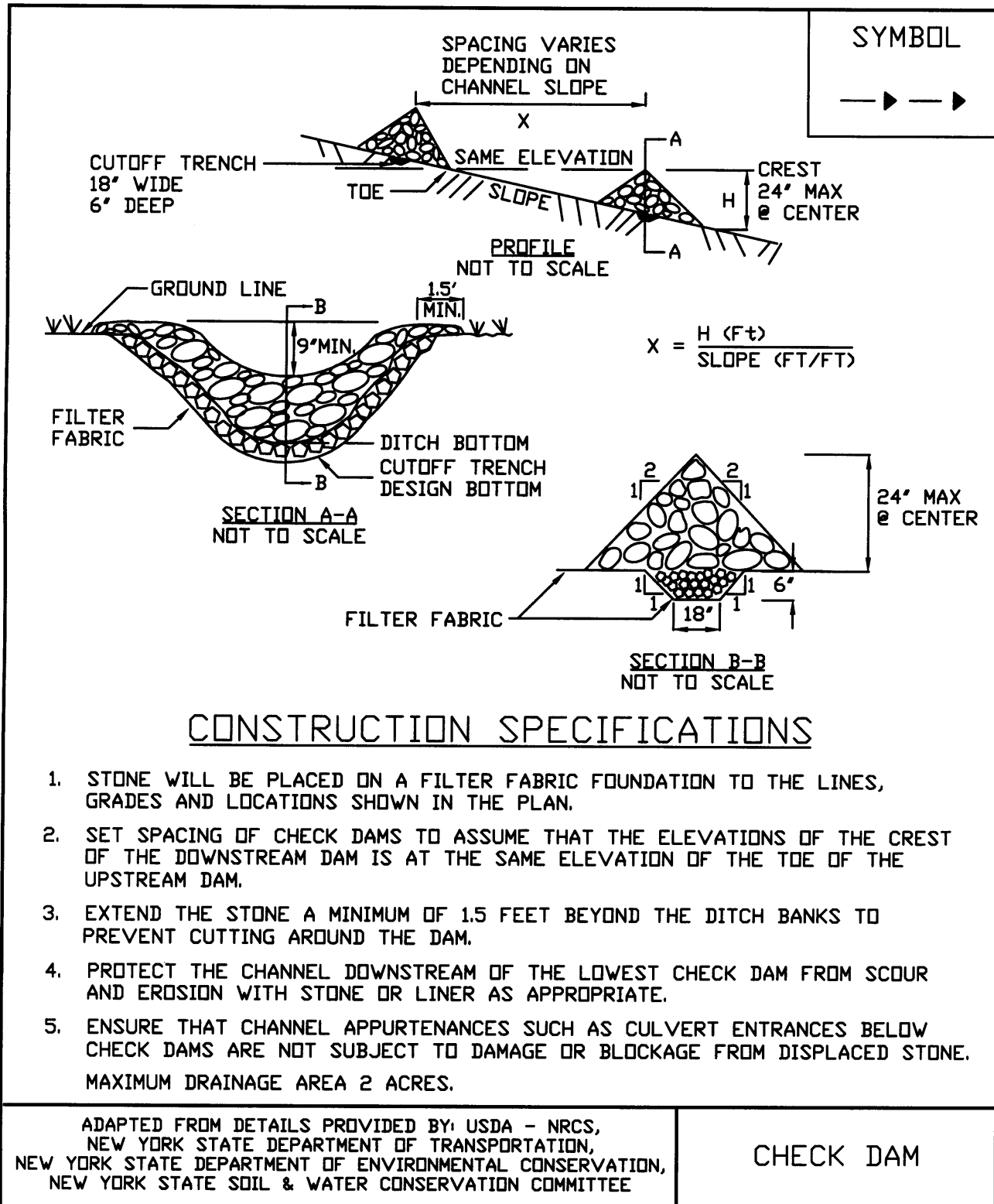

STANDARD AND SPECIFICATIONS FOR ROCK DAM



Definition

A rock embankment located to capture sediment.

Purpose

To retain sediment on the construction site and prevent sedimentation in off site water bodies.

Conditions Where Practice Applies

The rock dam may be used instead of the standard sediment basin with barrel and riser. The rock dam is preferred when it is difficult to construct a stable, earthen embankment and rock materials are readily available. The site should be accessible for periodic sediment removal. This rock dam should not be located in a perennial stream. The top of the dam will serve as the overflow outlet. The inside of the dam will be faced with smaller stone to reduce the rate of seepage so a sediment pool forms during runoff events.

Design Criteria

Drainage Area: The drainage area for this off stream structure is limited to 50 acres.

Location: The location of the dam should:

- provide a large area to trap sediment
- intercept runoff from disturbed areas
- be accessible to remove sediment
- not interfere with construction activities

Storage Volume: The storage volume behind the dam shall be at least 3,600 cubic feet per acre of drainage area to the dam. This volume is measured one foot below the crest of the dam.

Dam Section:

Top Width	5 feet minimum @ crest
Side Slopes	2:1 upstream slope 3:1 downstream slope
Height	6' max to spillway crest

Length of Crest: The crest length should be designed to carry the 10 yr. peak runoff with a flow depth of 1 foot and 1 foot of freeboard.

Rock at the abutments should extend at least 2 feet above the spillway and be at least 2 feet thick. These rock abutments should extend at least one foot above the downstream slope to prevent abutment scour. A rock apron at least 1.5 feet thick should extend downstream from the toe of the dam a distance equal to the height of the dam to protect the outlet area from scour.

Rock Fill: The rock fill should be well graded, hard, erosion resistant stone with a minimum d_{50} size of 9 inches. A "key trench" lined with geotextile filter fabric should be installed in the soil foundation under the rock fill. The filter fabric must extend from the key trench to the downstream edge of the apron and abutments to prevent soil movement and piping under the dam.

The upstream face of the dam should be covered with a fine gravel (NYS-DOT #1 washed stone or equal) a minimum 3 feet thick to reduce the drainage rate.

Trapping Efficiency: To obtain maximum trapping efficiency, design for a long detention period. Usually a minimum of eight (8) hours before the basin is completely drained. Maximize the length of travel of sediment laden water from the inlet to the drain. Achieve a surface area equal to 0.01 acres per cfs (inflow) based on the 10-year storm.

See Figure 5A.10 on page 5A.26 for details.

Maintenance

Check the basin area after each rainfall event. Remove sediment and restore original volume when sediment accumulates to one-half the design volume. Check the structure for erosion, piping, and rock displacement after each significant event and replace immediately.

Remove the structure and any sediment immediately after the construction area has been permanently stabilized. All water should be removed from the basin prior to the removal of the rock dam. Sediment should be placed in designated disposal areas and not allowed to flow into streams or drainage ways during structure removal.

**Figure 5A.10
Rock Dam**

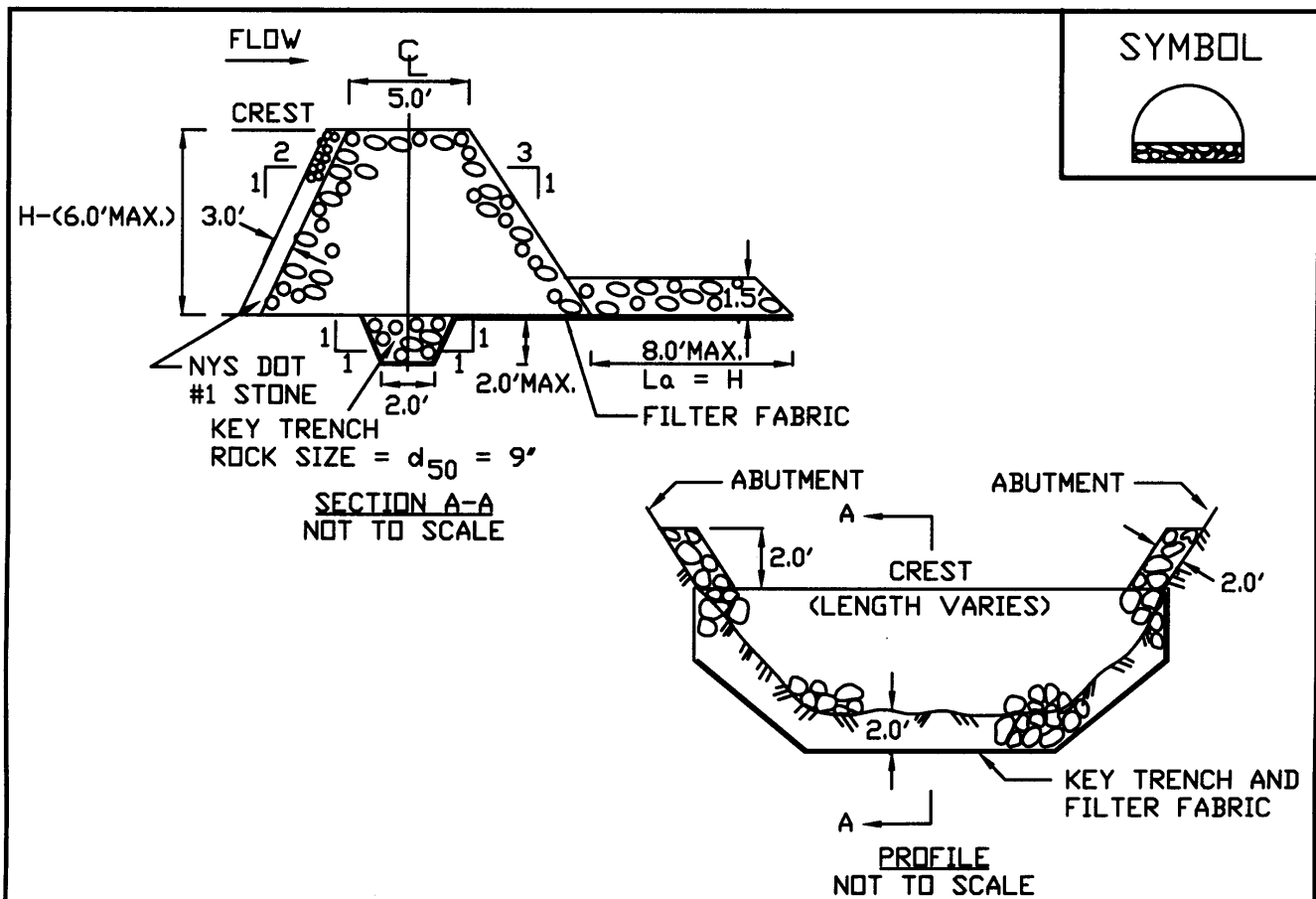

CONSTRUCTION SPECIFICATIONS

1. THE AREA UNDER THE ROCK DAM SHALL BE CLEARED AND STRIPPED OF ROOTS AND OTHER OBJECTIONABLE MATERIAL. THE RESERVOIR SHALL BE CLEARED AS NEEDED TO FACILITATE SEDIMENT REMOVAL.
2. DIMENSIONS SHOWN ARE MINIMUM. TRENCH SHALL BE EXCAVATED FROM ABUTMENT TO ABUTMENT ON THE DAM CENTERLINE. FILTER FABRIC SHALL BE PLACED FROM UPSTREAM EDGE OF KEYTRENCH TO DOWNSTREAM EDGE OF APRON. JOINTS WILL LAP A MINIMUM OF 1 FT. WITH UPSTREAM STRIP ON TOP.
3. CONSTRUCT THE ROCK EMBANKMENT TO THE DIMENSIONS SHOWN ON THE DRAWING. ROCK ABUTMENTS SHALL BE MAINTAINED 2 FT. ABOVE THE CREST.
4. THE ROCK DAM SHALL BE CONSTRUCTED PRIOR TO CLEARING THE BASIN AREA. STABILIZE ALL DISTURBED AREAS, EXCEPT THE BASIN AREA, WITH TEMPORARY SEEDING.
5. FENCES AND WARNING SIGNS SHOULD BE PLACED AS APPROPRIATE.

MAXIMUM DRAINAGE AREA: 50 ACRES

ADAPTED FROM DETAILS PROVIDED BY: USDA - NRCS,
NEW YORK STATE DEPARTMENT OF TRANSPORTATION,
NEW YORK STATE DEPARTMENT OF ENVIRONMENTAL CONSERVATION,
NEW YORK STATE SOIL & WATER CONSERVATION COMMITTEE

ROCK DAM

STANDARD AND SPECIFICATIONS FOR STORM DRAIN INLET PROTECTION



Definition

A temporary, somewhat permeable barrier, installed around inlets in the form of a fence, berm or excavation around an opening, trapping water and thereby reducing the sediment content of sediment laden water by settling.

Purpose

To prevent heavily sediment laden water from entering a storm drain system through inlets.

Conditions Where Practice Applies

This practice shall be used where the drainage area to an inlet is disturbed, it is not possible to temporarily divert the storm drain outfall into a trapping device, and watertight blocking of inlets is not advisable. **It is not to be used in place of sediment trapping devices.** This may be used in conjunction with storm drain diversion to help prevent siltation of pipes installed with low slope angle.

Types of Storm Drain Inlet Practices

There are four (4) specific types of storm drain inlet protection practices that vary according to their function, location, drainage area, and availability of materials:

- I. Excavated Drop Inlet Protection
- II. Fabric Drop Inlet Protection
- III. Stone & Block Drop Inlet Protection
- IV. Curb Drop Inlet Protection

Design Criteria

Drainage Area – The drainage area for storm drain inlets shall not exceed one acre. The crest elevations of these practices shall provide storage and minimize bypass flow.

Type I – Excavated Drop Inlet Protection

See details for Excavated Drop Inlet Protection in Figure 5A.11 on page 5A.29.

Limit the drainage area to the inlet device to 1 acre. Excavated side slopes shall be no steeper than 2:1. The minimum depth shall be 1 foot and the maximum depth 2 feet as measured from the crest of the inlet structure. Shape the excavated basin to fit conditions with the longest dimension oriented toward the longest inflow area to provide maximum trap efficiency. The capacity of the excavated basin should be established to contain 900 cubic feet per acre of disturbed area. Weep holes, protected by fabric and stone, should be provided for draining the temporary pool.

Inspect and clean the excavated basin after every storm. Sediment should be removed when 50 percent of the storage volume is achieved. This material should be incorporated into the site in a stabilized manner.

Type II – Fabric Drop Inlet Protection

See Figure 5A.12 for details on Filter Fabric Drop Inlet Protection on page 5A.30.

Limit the drainage area to 1 acre per inlet device. Land area slope immediately surrounding this device should not exceed 1 percent. The maximum height of the fabric above the inlet crest shall not exceed 1.5 feet unless reinforced.

The top of the barrier should be maintained to allow overflow to drop into the drop inlet and not bypass the inlet to unprotected lower areas. Support stakes for fabric shall be a minimum of 3 feet long, spaced a maximum 3 feet apart. They should be driven close to the inlet so any overflow drops into the inlet and not on the unprotected soil. Improved performance and sediment storage volume can be obtained by excavating the area.

Inspect the fabric barrier after each rain event and make repairs as needed. Remove sediment from the pool area as

necessary with care not to undercut or damage the filter fabric. Upon stabilization of the drainage area, remove all materials and unstable sediment and dispose of properly. Bring the adjacent area of the drop inlet to grade, smooth and compact and stabilize in the appropriate manner to the site.

If straw bales are used in lieu of filter fabric, they should be placed tight with the cut edge adhering to the ground at least 3 inches below the elevation of the drop inlet. Two anchor stakes per bale shall be driven flush to bale surface. Straw bales will be replaced every 4 months until the area is stabilized.

Type III – Stone and Block Drop Inlet Protection

See Figure 5A.13 for details on Stone and Block Drop Inlet Protection on page 5A.31.

Limit the drainage area to 1 acre at the drop inlet. The stone barrier should have a minimum height of 1 foot and a maximum height of 2 feet. Do not use mortar. The height should be limited to prevent excess ponding and bypass flow.

Recess the first course of blocks at least 2 inches below the crest opening of the storm drain for lateral support. Subsequent courses can be supported laterally if needed by placing a 2x4 inch wood stud through the block openings perpendicular to the course. The bottom row should have a few blocks oriented so flow can drain through the block to dewater the basin area.

The stone should be placed just below the top of the blocks on slopes of 2:1 or flatter. Place hardware cloth of wire mesh with ½ inch openings over all block openings to hold stone in place.

As an optional design, the concrete blocks may be omitted and the entire structure constructed of stone, ringing the outlet (“doughnut”). The stone should be kept at a 3:1 slope toward the inlet to keep it from being washed into the inlet.

A level area 1 foot wide and four inches below the crest will further prevent wash. Stone on the slope toward the inlet should be at least 3 inches in size for stability and 1 inch or smaller away from the inlet to control flow rate. The elevation of the top of the stone crest must be maintained 6 inches lower than the ground elevation down slope from the inlet to ensure that all storm flows pass over the stone into the storm drain and not past the structure. Temporary diking should be used as necessary to prevent bypass flow.

The barrier should be inspected after each rain event and repairs made where needed. Remove sediment as necessary to provide for accurate storage volume for subsequent rains. Upon stabilization of contributing drainage area, remove all materials and any unstable soil and dispose of properly.

Bring the disturbed area to proper grade, smooth, compact and stabilized in a manner appropriate to the site.

Type IV – Curb Drop Inlet Protection

See Figure 5A. 14 for details on Curb Drop Inlet Protection on page 5A.32.

The drainage area should be limited to 1 acre at the drop inlet. The wire mesh must be of sufficient strength to support the filter fabric and stone with the water fully impounded against it. Stone is to be 2 inches in size and clean. The filter fabric must be of a type approved for this purpose with an equivalent opening size (EOS) of 40-85. The protective structure will be constructed to extend beyond the inlet 2 feet in both directions. Assure that storm flow does not bypass the inlet by installing temporary dikes (such as sand bags) directing flow into the inlet. Make sure that the overflow weir is stable. Traffic safety shall be integrated with the use of this practice.

The structure should be inspected after every storm event. Any sediment should be removed and disposed of on the site. Any stone missing should be replaced. Check materials for proper anchorage and secure as necessary.

**Figure 5A.11
Excavated Drop Inlet Protection**

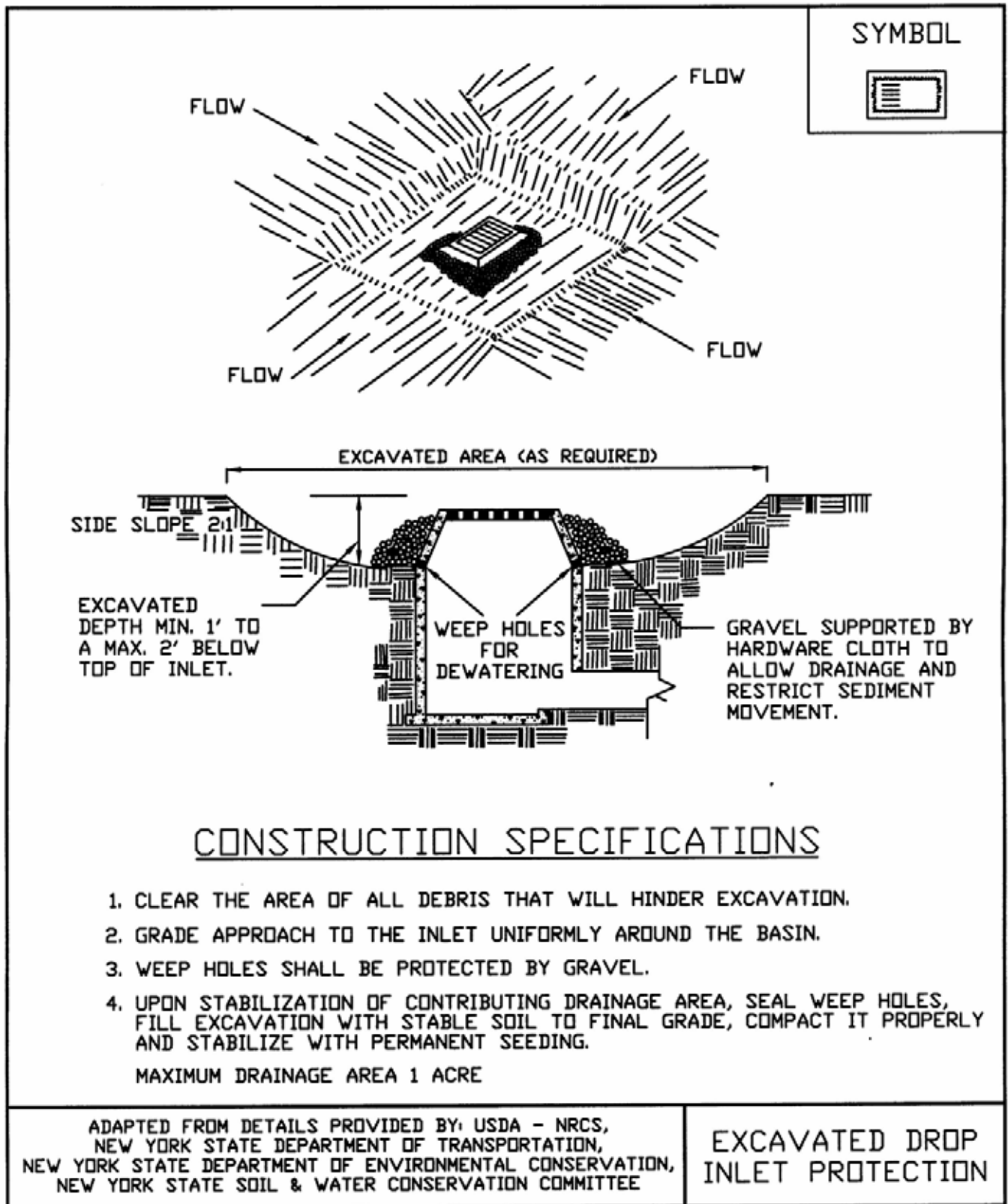

Figure 5A.12
Filter Fabric Drop Inlet Protection

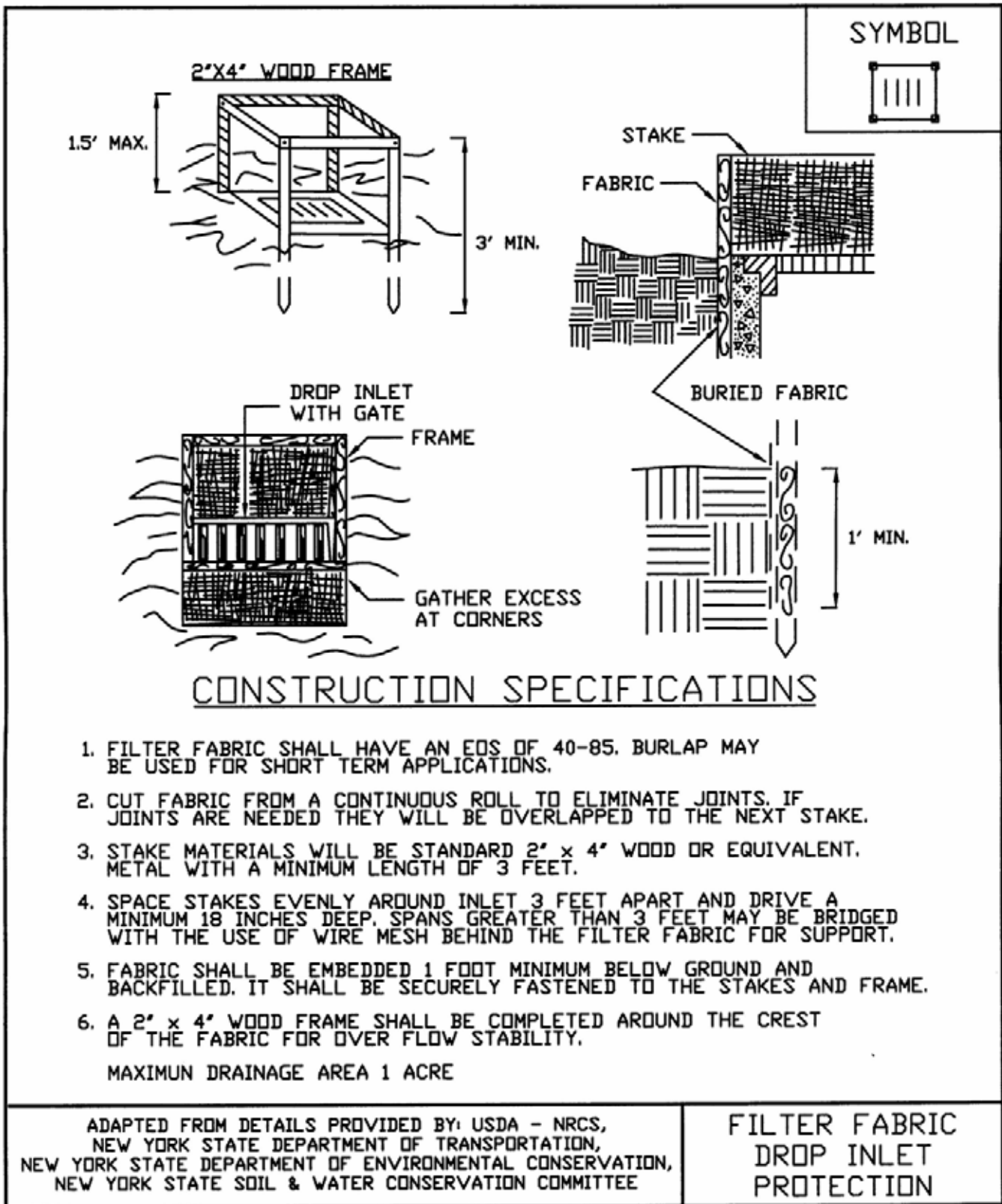

Figure 5A.13
Stone & Block Drop Inlet Protection

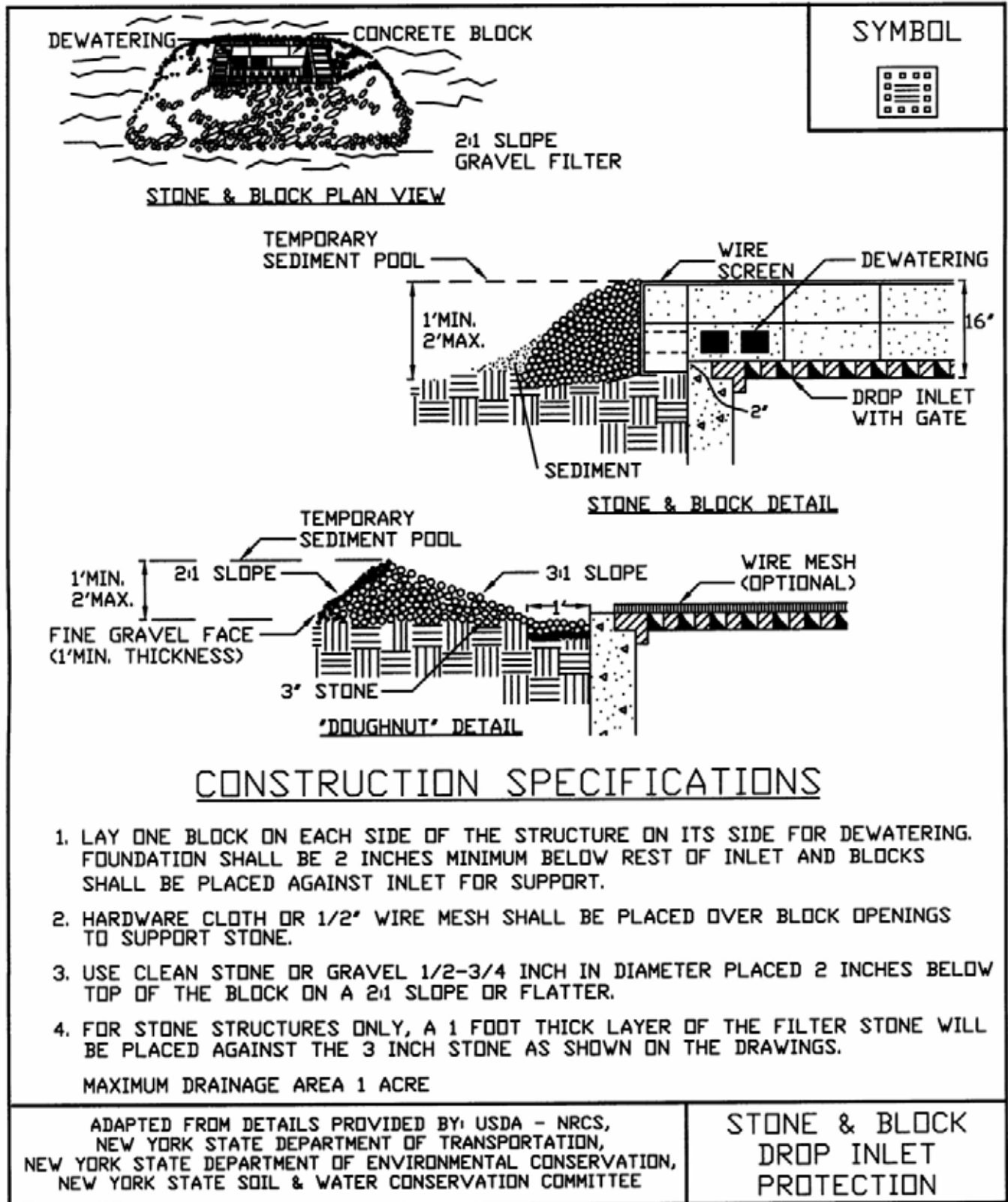
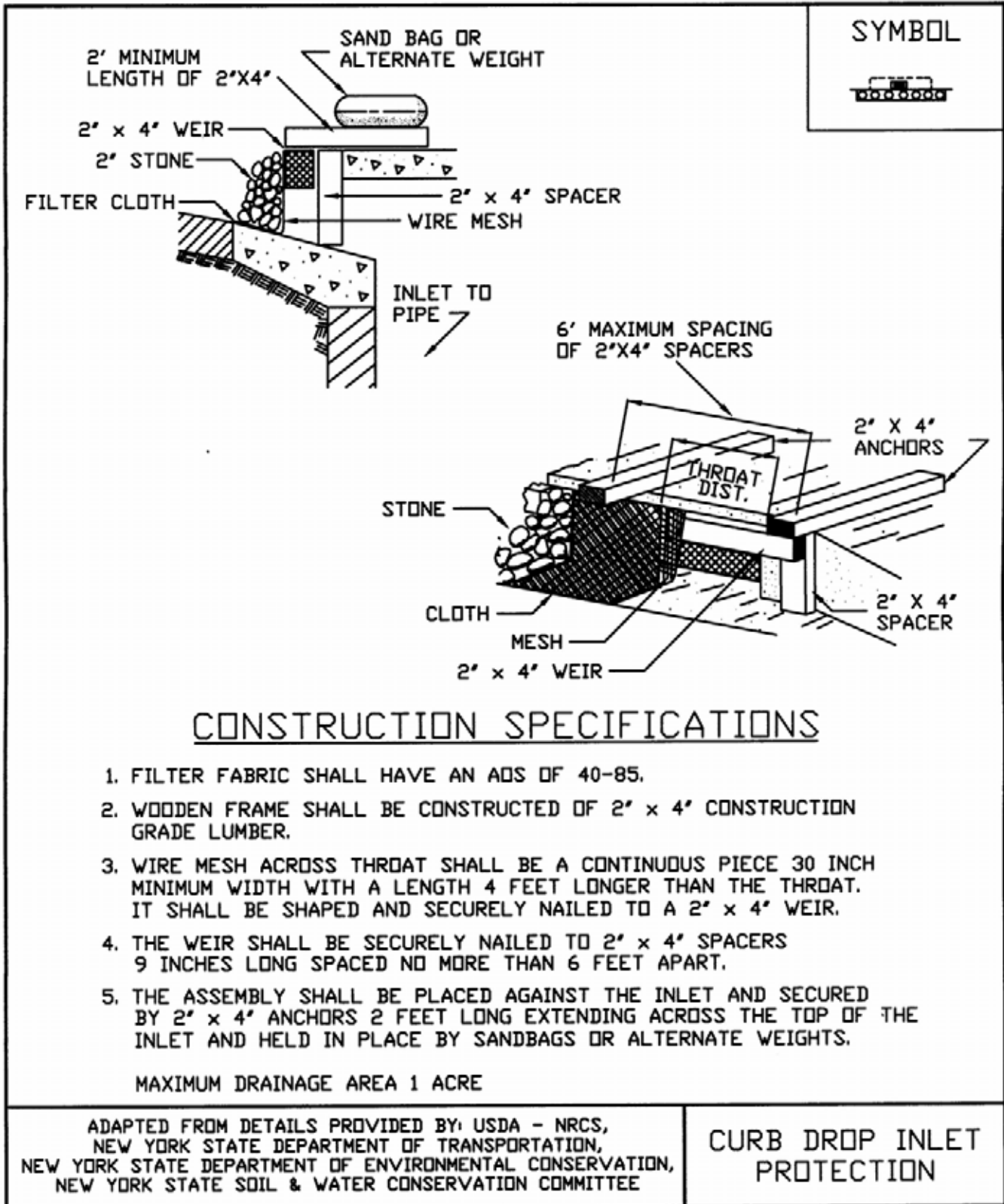

Figure 5A.14
Curb Drop Inlet Protection



STANDARD AND SPECIFICATIONS FOR TURBIDITY CURTAIN



Definition

A flexible, impenetrable barrier used to trap sediment in water bodies. This curtain is weighted at the bottom to achieve closure while supported at the top through a flotation system.

Purpose

To prevent the migration of silt from a work site in a water environment into the larger body of water.

Condition Where Practice Applies

A turbidity curtain is generally used when construction activity occurs within a waterbody or along its shoreline and is of short duration, generally less than one month. Curtains are used in calm water surfaces. **Turbidity curtains are not to be used across flowing watercourses.**

Design Criteria

The turbidity curtain shall be located beyond the lateral limits of the construction site and firmly anchored in place. The alignment should be set as close to the work area as

possible but not so close as to be disturbed by applicable construction equipment. The height of the curtain shall be 20 percent greater than the depth of the water to allow for water level fluctuations. The area that the turbidity curtain protects shall not contain large culverts or drainage areas that if flows occur behind the curtain would cause a breach or lost contact at the bottom surface.

If water depths at the design alignment are minimal, the toe can be anchored in place by staking.

See Figure 5A.15 on page 5A.34.

Construction Specifications

The area of proposed installation of the curtain shall be inspected for obstacles and impediments that could damage the curtain or impair its effectiveness to retain sediment. All materials shall be removed so they cannot enter the waterbody. Shallow installations can be made by securing the curtain by staking rather than using a flotation system. Supplemental anchors of the turbidity curtain toe shall be used, as needed, depending on water surface disturbances such as boats and wave action by winds.

Maintenance

The turbidity curtain shall be inspected daily and repaired or replaced immediately. It is not normally necessary to remove sediment deposited behind the curtain; but, when necessary, removal is usually done by hand prior to removal of the barrier. All removed silt is stabilized away from the waterbody. The barrier shall be removed by carefully pulling it toward the construction site to minimize the release of attached sediment. Any floating construction or natural debris shall be immediately removed to prevent damage to the curtain. If the curtain is oriented in a manner that faces the prevailing winds, frequent checks of the anchorage shall be made.

**Figure 5A.15
Turbidity Curtain**

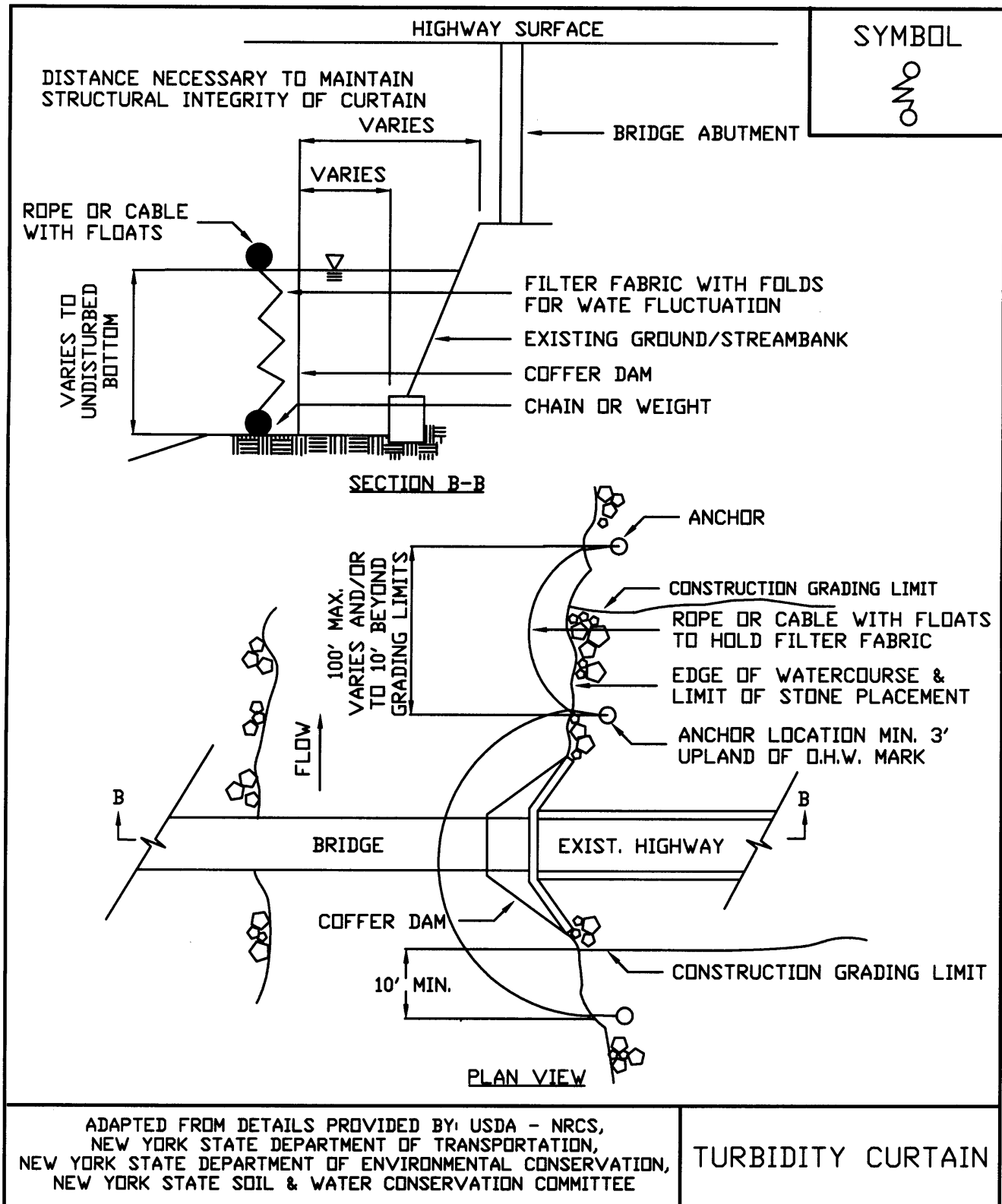

STANDARD AND SPECIFICATIONS FOR SEDIMENT TRAP



Definition

A temporary sediment control device formed by excavation and/or embankment to intercept sediment laden runoff and retain the sediment.

Purpose

The purpose of the structure is to intercept sediment-laden runoff and trap the sediment in order to protect drainage ways, properties, and rights-of-way below the sediment trap from sedimentation.

Conditions Where Practice Applies

A sediment trap is usually installed in a drainage way, at a storm drain inlet, or other points of collection from a disturbed area.

Sediment traps should be used to artificially break up the natural drainage area into smaller sections where a larger device (sediment basin) would be less effective.

Design Criteria

If any of the design criteria presented here cannot be met, see Standard and Specification for Sediment Basin on page 5A.49.

Drainage Area

The drainage area for sediment traps shall be in accordance with the specific type of sediment trap used (Type I through V).

Location

Sediment traps shall be located so that they can be installed

prior to grading or filling in the drainage area they are to protect. Traps must not be located any closer than 20 feet from a proposed building foundation if the trap is to function during building construction. Locate traps to obtain maximum storage benefit from the terrain and for ease of cleanout and disposal of the trapped sediment.

Trap Size

The volume of a sediment trap as measured at the elevation of the crest of the outlet shall be at least 3,600 cubic feet per acre of drainage area. The volume of a constructed trap shall be calculated using standard mathematical procedures. The volume of a natural sediment trap may be approximated by the equation: Volume (cu.ft.) = 0.4 x surface area (sq.ft.) x maximum depth (ft.).

Trap Cleanout

Sediment shall be removed and the trap restored to the original dimensions when the sediment has accumulated to ½ of the design depth of the trap. Sediment removed from the trap shall be deposited in a protected area and in such a manner that it will not erode.

Embankment

All embankments for sediment traps shall not exceed five (5) feet in height as measured at the low point of the original ground along the centerline of the embankment. Embankments shall have a minimum four (4) foot wide top and side slopes of 2:1 or flatter. The embankment shall be compacted by traversing with equipment while it is being constructed. The embankment shall be stabilized with seed and mulch as soon as it is completed

The elevation of the top of any dike directing water to any sediment trap will equal or exceed the maximum height of the outlet structure along the entire length of the trap.

Excavation

All excavation operations shall be carried out in such a manner that erosion and water pollution shall be minimal. Excavated portions of sediment traps shall have 1:1 or flatter slopes.

Outlet

The outlet shall be designed, constructed, and maintained in such a manner that sediment does not leave the trap and that erosion at or below the outlet does not occur.

Sediment traps must outlet onto stabilized (preferable undisturbed) ground, into a watercourse, stabilized channel, or into a storm drain system. Distance between inlet and outlet should be maximized to the longest length practicable.

Trap Details Needed on Erosion and Sediment Control Plans

Each trap shall be delineated on the plans in such a manner that it will not be confused with any other features. Each trap on a plan shall indicate all the information necessary to properly construct and maintain the structure. If the drawings are such that this information cannot be delineated on the drawings, then a table shall be developed. If a table is developed, then each trap on a plan shall have a number and the numbers shall be consecutive.

The following information shall be shown for each trap in a summary table format on the plans.

1. Trap number
2. Type of trap
3. Drainage area
4. Storage required
5. Storage provided (if applicable)
6. Outlet length or pipe sizes
7. Storage depth below outlet or cleanout elevation
8. Embankment height and elevation (if applicable)

Type of Sediment Traps

There are five (5) specific types of sediment traps which vary according to their function, location, or drainage area.

- I. Pipe Outlet Sediment Trap
- II. Grass Outlet Sediment Trap
- III. Catch Basin Sediment Trap
- IV. Stone Outlet Sediment Trap
- V. Riprap Outlet Sediment Trap

I. Pipe Outlet Sediment Trap

A Pipe Outlet Sediment Trap consists of a trap formed by embankment or excavation. The outlet for the trap is through a perforated riser and a pipe through the embankment. The outlet pipe and riser shall be made of steel, corrugated metal or other suitable material. The top of the embankment shall be at least 1 ½ feet above the crest of the riser. The top 2/3 of the riser shall be perforated with one (1) inch nominal diameter holes or slits spaced six (6) inches vertically and horizontally placed in the concave portion of the corrugated pipe.

No holes or slits will be allowed within six (6) inches of the top of the horizontal barrel. All pipe connections shall be watertight. The riser shall be wrapped with ½ to ¼ inch hardware cloth wire then wrapped with filter cloth with a sieve size between #40-80 and secured with strapping or

connecting band at the top and bottom of the cloth. The cloth shall cover an area at least six (6) inches above the highest hole and six (6) inches below the lowest hole. The top of the riser pipe shall not be covered with filter cloth. The riser shall have a base with sufficient weight to prevent flotation of the riser. Two approved bases are:

1. A concrete base 12 in. thick with the riser embedded 9 in. into the concrete base, or
2. One quarter inch, minimum, thick steel plate attached to the riser by a continuous weld around the circumference of the riser to form a watertight connection. The plate shall have 2.5 feet of stone, gravel, or earth placed on it to prevent flotation. In either case, each side of the square base measurement shall be the riser diameter plus 24 inches.

Pipe outlet sediment traps shall be limited to a five (5) acre maximum drainage area. Pipe outlet sediment traps may be interchangeable in the field with stone outlet or riprap sediment traps provided that these sediment traps are constructed in accordance with the detail and specifications for that trap.

Select pipe diameter from the following table:

Minimum Sizes

Barrel Diameter ¹ (in.)	Riser Diameter ¹ (in.)	Maximum Drainage Area (ac.)
12	15	1
15	18	2
18	21	3
21	24	4
21	27	5

¹ Barrel diameter may be same size as riser diameter.

See details for Pipe Outlet Sediment Trap ST-I in Figure 5A.16 (1) and 5A.16 (2) on pages 5A.38 and 5A.39.

II. Grass Outlet Sediment Trap

A Grass Outlet Sediment Trap consists of a trap formed by excavating the earth to create a holding area. The trap has a discharge point over natural existing grass. The outlet crest width (feet) shall be equal to four (4) times the drainage area (acres) with a minimum width of four (4) feet. The outlet shall be free of any restrictions to flow. The outlet lip must remain undisturbed and level. The volume of this trap shall be computed at the elevation of the crest of the outlet. Grass outlet sediment traps shall be limited to a five (5) acre maximum drainage area.

See details for Grass Outlet Sediment Trap ST-II in Figure 5A.17 on page 5A.40.

III. Catch Basin Sediment Trap

A Catch Basin Sediment Trap consists of a basin formed by excavation on natural ground that discharges through an opening in a storm drain inlet structure. This opening can either be the inlet opening or a temporary opening made by omitting bricks or blocks in the inlet.

A yard drain inlet or an inlet in the median strip of a dual highway could use the inlet opening for the type outlet. The trap should be out of the roadway so as not to interfere with future compaction or construction. Placing the trap on the opposite side of the opening and diverting water from the roadway to the trap is one means of doing this. Catch basin sediment traps shall be limited to a three (3) acre maximum drainage area. The volume of this trap is measured at the elevation of the crest of the outlet (invert of the inlet opening).

See details for Catch Basin Sediment Trap ST-III in Figure 5A.18 on page 5A.41.

IV. Stone Outlet Sediment Trap

A Stone Outlet Sediment Trap consists of a trap formed by an embankment or excavation. The outlet of this trap is over a stone section placed on level ground. The minimum length (feet) of the outlet shall be equal to four (4) times the drainage area (acres).

Required storage shall be 3,600 cubic feet per acre of drainage area.

The outlet crest (top of stone in weir section) shall be level, at least one (1) foot below top of embankment and no more than one (1) foot above ground beneath the outlet. Stone used in the outlet shall be small riprap (4 in. x 8 in.). To provide more efficient trapping effect, a layer of filter cloth should be embedded one (1) foot back into the upstream face of the outlet stone or a one (1) foot thick layer of two (2) inch or finer aggregate shall be placed on the upstream face of the outlet.

Stone Outlet Sediment Traps may be interchangeable in the field with pipe or riprap outlet sediment traps provided they are constructed in accordance with the detail and specifications for those traps. Stone outlet sediment traps shall be limited to a five (5) acre maximum drainage area.

See details for Stone Outlet Sediment Trap ST-IV in Figure 5A.19 on page 5A.42.

V. Riprap Outlet Sediment Trap

A Riprap Outlet Sediment Trap consists of a trap formed by an excavation and embankment. The outlet for this trap

shall be through a partially excavated channel lined with riprap. This outlet channel shall discharge onto a stabilized area or to a stable watercourse. The riprap outlet sediment trap may be used for drainage areas of up to a maximum of 15 acres.

Design Criteria for Riprap Outlet Sediment Trap

1. The total contributing drainage area (disturbed or undisturbed either on or off the developing property) shall not exceed 15 acres.
2. The storage needs for this trap shall be computed using 3600 cubic feet of required storage for each acre of drainage area. The storage volume provided can be figured by computing the volume of storage area available behind the outlet structure up to an elevation of one (1) foot below the level weir crest.
3. The maximum height of embankment shall not exceed five (5) feet.
4. The elevation of the top of any dike directing water to a riprap outlet sediment trap will equal or exceed the minimum elevation of the embankment along the entire length of this trap.

Riprap Outlet Sediment Trap ST-V (for Stone Lined Channel)

Contributing Drainage Area (ac.)	Depth of Channel (a) (ft.)	Length of Weir (b) (ft.)
1	1.5	4.0
2	1.5	5.0
3	1.5	6.0
4	1.5	10.0
5	1.5	12.0
6	1.5	14.0
7	1.5	16.0
8	2.0	10.0
9	2.0	10.0
10	2.0	12.0
11	2.0	14.0
12	2.0	14.0
13	2.0	16.0
14	2.0	16.0
15	2.0	18.0

See details for Riprap Outlet Sediment Trap ST-V on Figures 5A.20(1) and 5A.20(2) on pages 5A.43 and 5A.44.

Optional Dewatering Methods

Optional dewatering devices may be designed for use with sediment traps. Included are two methods, which may be used. See Figure 5A.21 on page 5A.45 for details.

Figure 5A.16(1)
Pipe Outlet Sediment Trap: ST-I

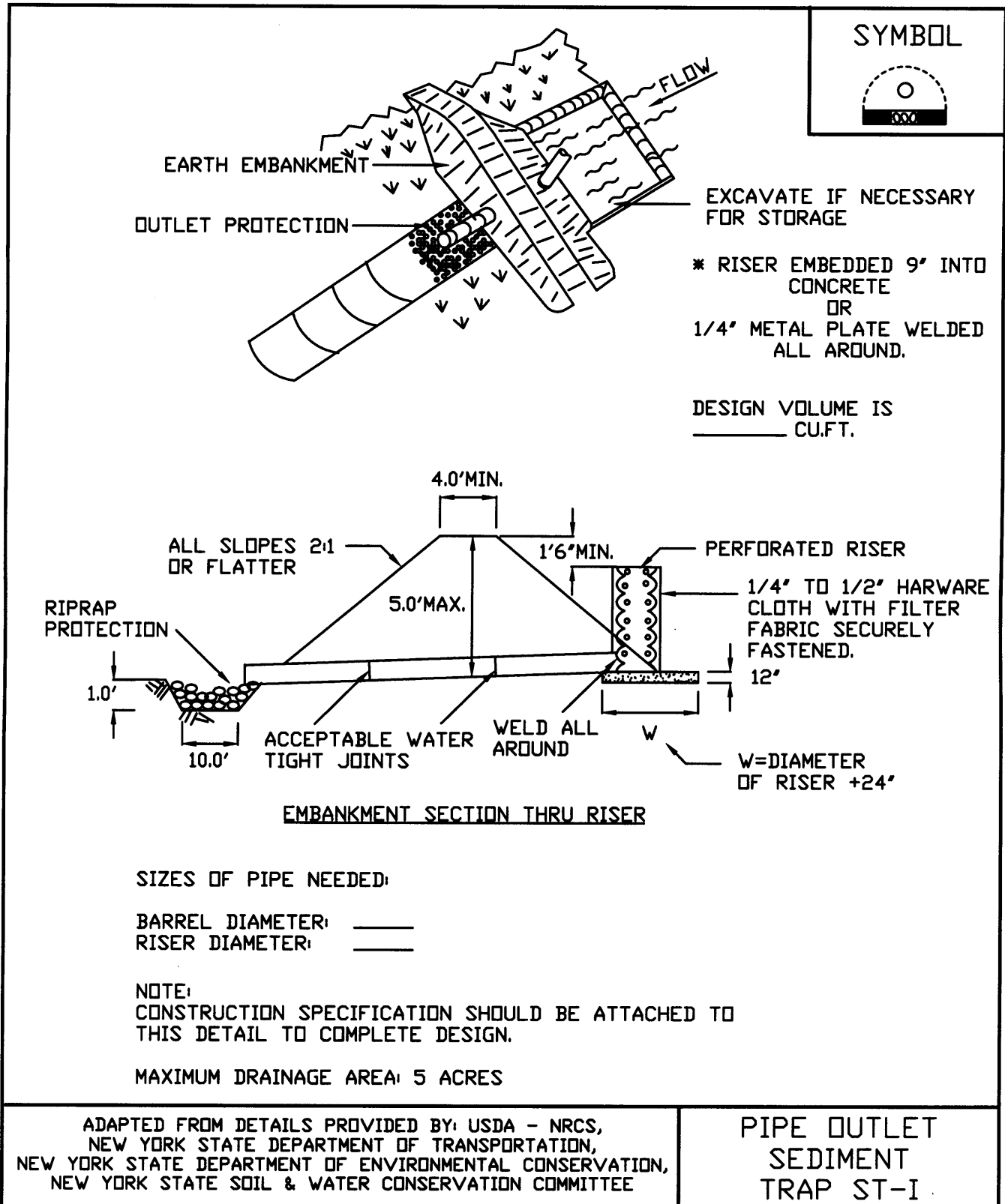

Figure 5A.16(2)
Pipe Outlet Sediment Trap: ST-I—Construction Specifications

<p>CONSTRUCTION SPECIFICATIONS</p>	<p>SYMBOL</p> 
<ol style="list-style-type: none"> 1. AREA UNDER EMBANKMENT SHALL BE CLEARED, GRUBBED AND STRIPPED OF ANY VEGETATION AND ROOT MAT. THE POOL AREA SHALL BE CLEARED. 2. THE FILL MATERIAL FOR THE EMBANKMENT SHALL BE FREE OF ROOTS OR OTHER WOODY VEGETATION AS WELL AS OVER-SIZED STONES, ROCKS, ORGANIC MATERIAL, OR OTHER OBJECTIONABLE MATERIAL. THE EMBANKMENT SHALL BE COMPACTED BY TRAVERSING WITH EQUIPMENT WHILE IT IS BEING CONSTRUCTED. 3. VOLUME OF SEDIMENT STORAGE SHALL BE 3600 CUBIC FEET PER ACRE OF CONTRIBUTORY DRAINAGE. 4. SEDIMENT SHALL BE REMOVED AND TRAP RESTORED TO ITS ORIGINAL DIMENSIONS WHEN THE SEDIMENT HAS ACCUMULATED TO 1/2 THE DESIGN DEPTH OF THE TRAP. REMOVED SEDIMENT SHALL BE DEPOSITED IN A SUITABLE AREA AND STABILIZED. 5. THE STRUCTURE SHALL BE INSPECTED AFTER EACH RAIN AND REPAIRS MADE AS NEEDED. 6. CONSTRUCTION OPERATIONS SHALL BE CARRIED OUT IN SUCH A MANNER THAT EROSION AND SEDIMENT ARE CONTROLLED. 7. THE STRUCTURE SHALL BE REMOVED AND AREA STABILIZED WHEN THE DRAINAGE AREA HAS BEEN PROPERLY STABILIZED. 8. ALL FILL SLOPES SHALL BE 2:1 OR FLATTER; CUT SLOPES 1:1 OR FLATTER. 9. ALL PIPE CONNECTIONS SHALL BE WATERTIGHT. 10. THE TOP 2/3 OF THE RISER SHALL BE PERFORATED WITH ONE (1) INCH DIAMETER HOLES OR SLITS SPACED SIX (6) INCHES VERTICALLY AND HORIZONTALLY AND PLACED IN THE CONCAVE PORTION OF PIPE. NO HOLES WILL BE ALLOWED WITHIN SIX (6) INCHES OF THE HORIZONTAL BARREL. 11. THE RISER SHALL BE WRAPPED WITH 1/4 TO 1/2 INCH HARDWARE CLOTH WIRE THEN WRAPPED WITH FILTER CLOTH (HAVING AN EQUIVALENT SIEVE SIZE OF 40-80). THE FILTER CLOTH SHALL EXTEND SIX (6) INCHES ABOVE THE HIGHEST HOLE AND SIX (6) INCHES BELOW THE LOWEST HOLE. WHERE ENDS OF THE FILTER CLOTH COME TOGETHER, THEY SHALL BE OVER-LAPPED, FOLDED AND STAPLED TO PREVENT BYPASS. 12. STRAPS OR CONNECTING BANDS SHALL BE USED TO HOLD THE FILTER CLOTH AND WIRE FABRIC IN PLACE. THEY SHALL BE PLACED AT THE TOP AND BOTTOM OF THE CLOTH. 13. FILL MATERIAL AROUND THE PIPE SPILLWAY SHALL BE HAND COMPACTED IN FOUR (4) INCH LAYERS. A MINIMUM OF TWO (2) FEET OF HAND COMPACTED BACKFILL SHALL BE PLACED OVER THE PIPE SPILLWAY BEFORE CROSSING IT WITH CONSTRUCTION EQUIPMENT. 14. THE RISER SHALL BE ANCHORED WITH EITHER A CONCRETE BASE OR STEEL PLATE BASE TO PREVENT FLOTATION. FOR CONCRETE BASED THE DEPTH SHALL BE TWELVE (12) INCHES WITH THE RISER EMBEDDED NINE (9) INCHES. A 1/4 INCH MINIMUM THICKNESS STEEL PLATE SHALL BE ATTACHED TO THE RISER BY A CONTINUOUS WELD AROUND THE BOTTOM TO FORM A WATERTIGHT CONNECTION AND THEN PLACE TWO (2) FEET OF STONE, GRAVEL, OR TAMPED EARTH ON THE PLATE. 	
<p>ADAPTED FROM DETAILS PROVIDED BY: USDA - NRCS, NEW YORK STATE DEPARTMENT OF TRANSPORTATION, NEW YORK STATE DEPARTMENT OF ENVIRONMENTAL CONSERVATION, NEW YORK STATE SOIL & WATER CONSERVATION COMMITTEE</p>	<p>PIPE OUTLET SEDIMENT TRAP ST-I</p>

Figure 5A.17
Grass Outlet Sediment Trap: ST-II

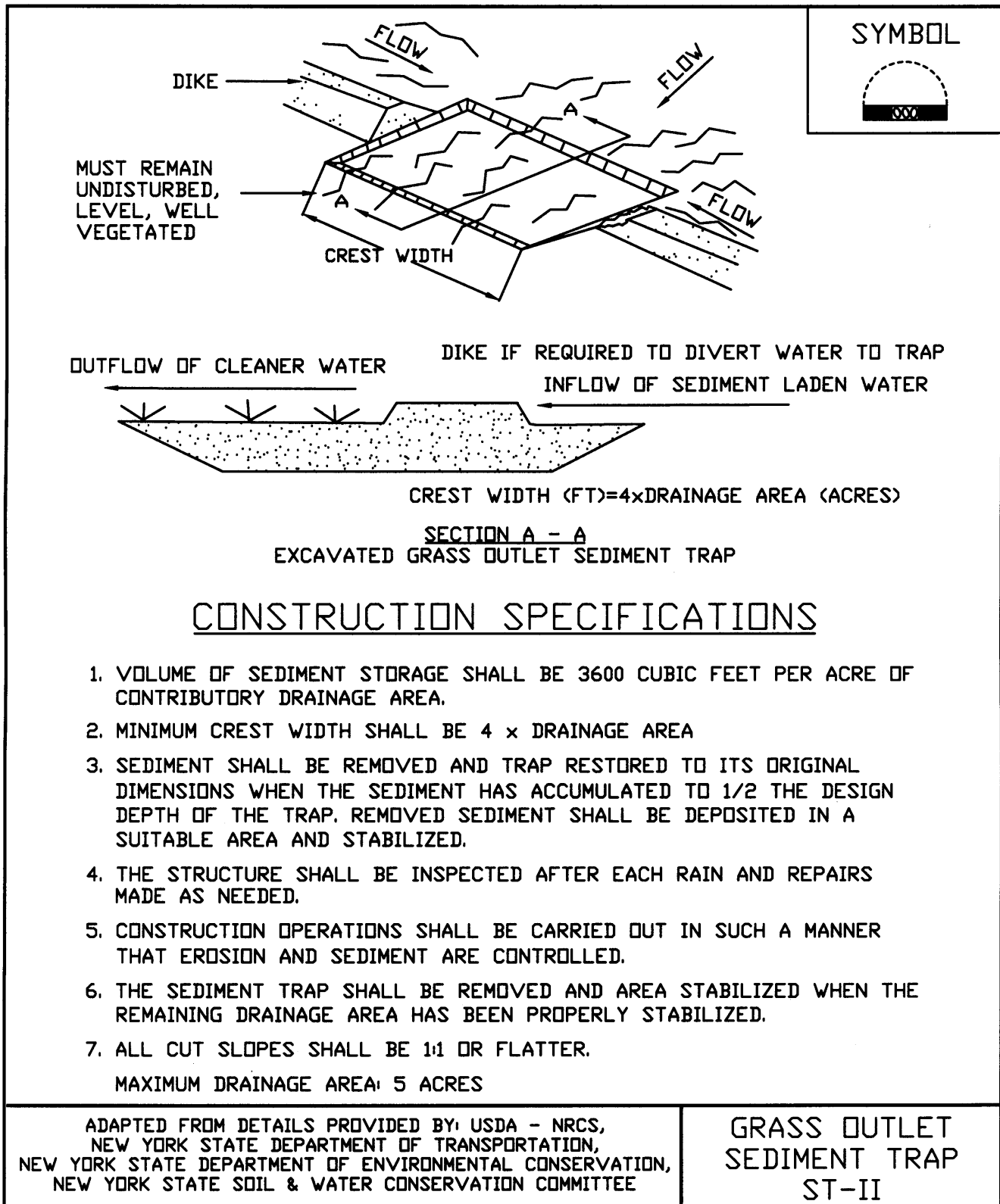

Figure 5A.18
Catch Basin Sediment Trap: ST-III

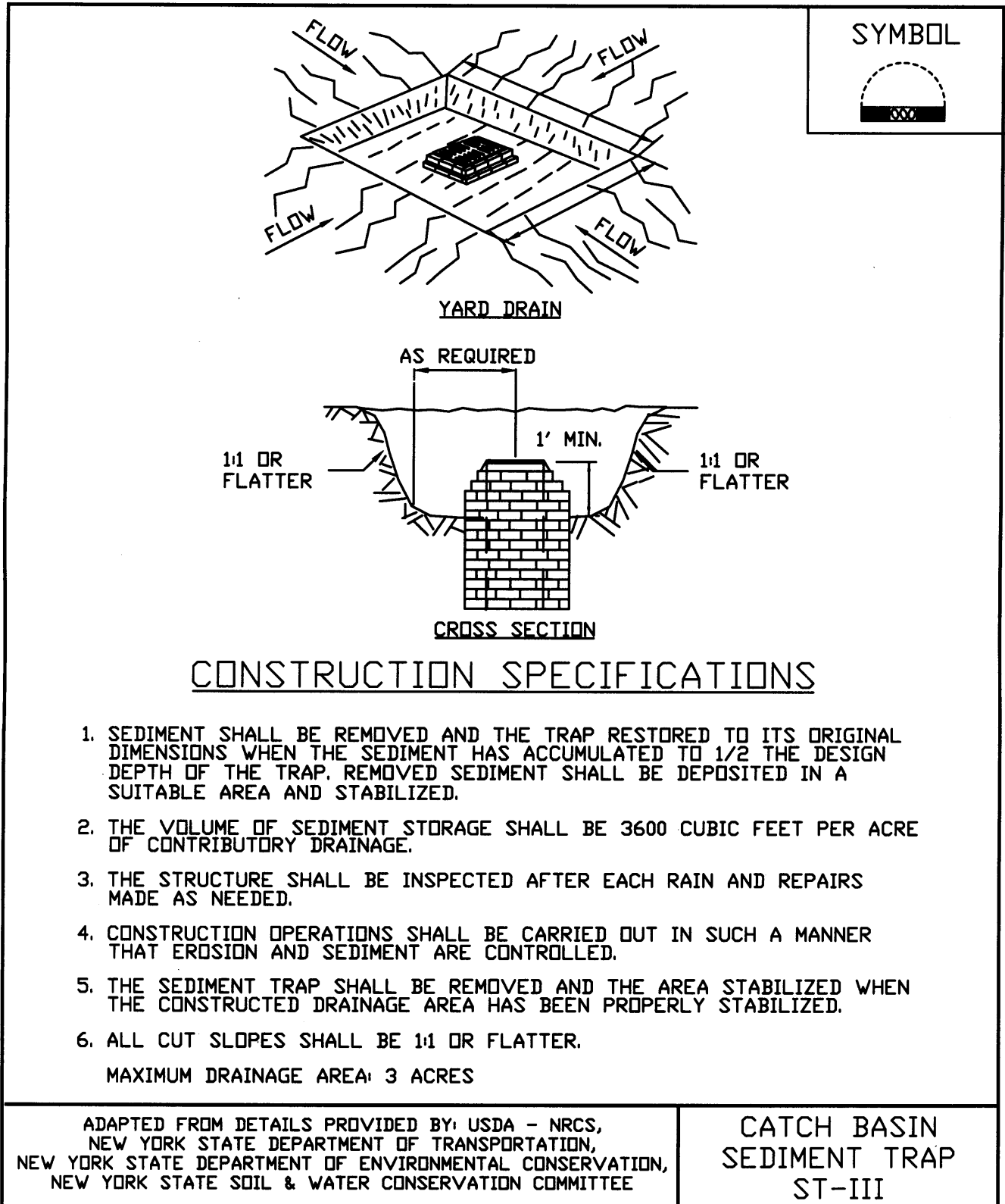
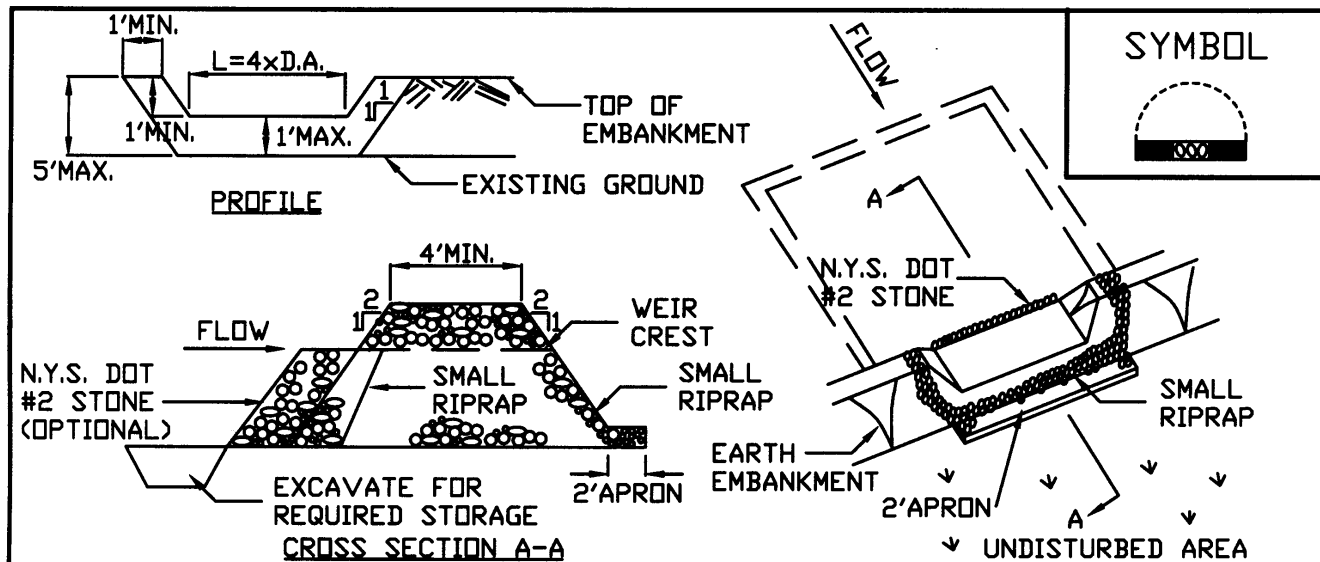

Figure 5A.19
Stone Outlet Sediment Trap: ST-IV



OPTION: A ONE FOOT LAYER OF N.Y.S. DOT #2 STONE MAY BE PLACED ON THE UPSTREAM SIDE OF THE RIPRAP IN PLACE OF THE EMBEDDED FILTER CLOTH.

CONSTRUCTION SPECIFICATIONS

1. AREA UNDER EMBANKMENT SHALL BE CLEARED, GRUBBED AND STRIPPED OF ANY VEGETATION AND ROOT MAT. THE POOL AREA SHALL BE CLEARED.
2. THE FILL MATERIAL FOR THE EMBANKMENT SHALL BE FREE OF ROOTS AND OTHER WOODY VEGETATION AS WELL AS OVER-SIZED STONES, ROCKS, ORGANIC MATERIAL OR OTHER OBJECTIONABLE MATERIAL. THE EMBANKMENT SHALL BE COMPACTED BY TRAVERSING WITH EQUIPMENT WHILE IT IS BEING CONSTRUCTED.
3. ALL CUT AND FILL SLOPES SHALL BE 2:1 OR FLATTER.
4. THE STONE USED IN THE OUTLET SHALL BE SMALL RIPRAP 4"-8" ALONG WITH A 1' THICKNESS OF 2" AGGREGATE PLACED ON THE UP-GRADE SIDE ON THE SMALL RIPRAP OR EMBEDDED FILTER CLOTH IN THE RIPRAP.
5. SEDIMENT SHALL BE REMOVED AND TRAP RESTORED TO ITS ORIGINAL DIMENSIONS WHEN THE SEDIMENT HAS ACCUMULATED TO 1/2 THE DESIGN DEPTH OF THE TRAP. IT SHALL BE PLACED ON SITE AND STABILIZED.
6. THE STRUCTURE SHALL BE INSPECTED AFTER EACH RAIN AND REPAIRS MADE AS NEEDED.
7. CONSTRUCTION OPERATIONS SHALL BE CARRIED OUT IN SUCH A MANNER THAT EROSION AND SEDIMENT ARE CONTROLLED.
8. THE STRUCTURE SHALL BE REMOVED AND THE AREA STABILIZED WHEN THE DRAINAGE AREA HAS BEEN PROPERLY STABILIZED.

MAXIMUM DRAINAGE AREA 5 ACRES

ADAPTED FROM DETAILS PROVIDED BY: USDA - NRCS,
NEW YORK STATE DEPARTMENT OF TRANSPORTATION,
NEW YORK STATE DEPARTMENT OF ENVIRONMENTAL CONSERVATION,
NEW YORK STATE SOIL & WATER CONSERVATION COMMITTEE

STONE OUTLET
SEDIMENT TRAP
ST-IV

Figure 5A.20(1)
Riprap Outlet Sediment Trap: ST-V

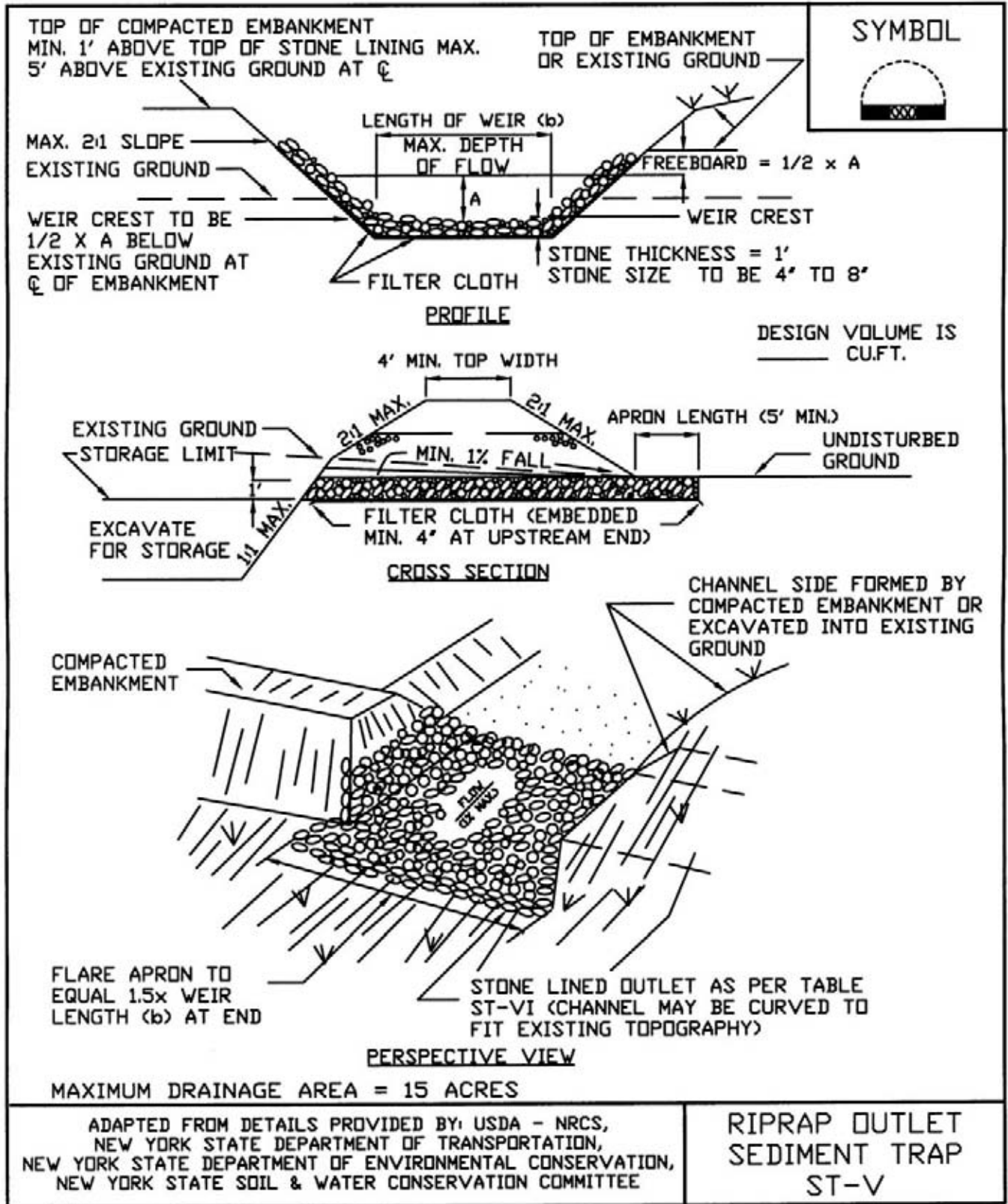

Figure 5A.202)

Riprap Outlet Sediment Trap: ST-V—Construction Specifications

<p>SYMBOL</p> 	
<h2><u>CONSTRUCTION SPECIFICATIONS</u></h2>	
<ol style="list-style-type: none">1. THE AREA UNDER EMBANKMENT SHALL BE CLEARED, GRUBBED AND STRIPPED OF ANY VEGETATION AND ROOT MAT. THE POOL AREA SHALL BE CLEARED.2. THE FILL MATERIAL FOR THE EMBANKMENT SHALL BE FREE OF ROOTS OR OTHER WOODY VEGETATION AS WELL AS OVER-SIZED STONES, ROCKS, ORGANIC MATERIAL OR OTHER OBJECTIONABLE MATERIAL. THE EMBANKMENT SHALL BE COMPACTED BY TRAVERSING WITH EQUIPMENT WHILE IT IS BEING CONSTRUCTED. MAXIMUM HEIGHT OF OF EMBANKMENT SHALL BE FIVE (5) FEET, MEASURED AT CENTERLINE OF EMBANKMENT.3. ALL FILL SLOPES SHALL BE 2:1 OR FLATTER, CUT SLOPES 1:1 OR FLATTER.4. ELEVATION OF THE TOP OF ANY DIKE DIRECTING WATER INTO TRAP MUST EQUAL OR EXCEED THE HEIGHT OF EMBANKMENT.5. STORAGE AREA PROVIDED SHALL BE FIGURED BY COMPUTING THE VOLUME AVAILABLE BEHIND THE OUTLET CHANNEL UP TO AN ELEVATION OF ONE (1) FOOT BELOW THE LEVEL WEIR CREST.6. FILTER CLOTH SHALL BE PLACED OVER THE BOTTOM AND SIDES OF THE OUTLET CHANNEL PRIOR TO PLACEMENT OF STONE. SECTIONS OF FABRIC MUST OVERLAP AT LEAST ONE (1) FOOT WITH SECTION NEAREST THE ENTRANCE PLACED ON TOP. FABRIC SHALL BE EMBEDDED AT LEAST SIX (6) INCHES INTO EXISTING GROUND AT ENTRANCE OUTLET CHANNEL.7. STONE USED IN THE OUTLET CHANNEL SHALL BE FOUR (4) TO EIGHT (8) INCH RIPRAP. TO PROVIDE A FILTERING EFFECT, A LAYER OF FILTER CLOTH SHALL BE EMBEDDED ONE (1) FOOT WITH SECTION NEAREST ENTRANCE PLACED ON TOP. FABRIC SHALL BE EMBEDDED AT LEAST SIX (6) INCHES INTO EXISTING GROUND AT ENTRANCE OF OUTLET CHANNEL.8. SEDIMENT SHALL BE REMOVED AND TRAP RESTORED TO ITS ORIGINAL DIMENSIONS WHEN SEDIMENT HAS ACCUMULATED TO 1/2 THE DESIGN DEPTH OF THE TRAP. REMOVED SEDIMENT SHALL BE DEPOSITED IN A SUITABLE AREA AND IN SUCH A MANNER THAT IT WILL NOT ERODE.9. THE STRUCTURE SHALL BE INSPECTED AFTER EACH RAIN AND REPAIRED AS NEEDED.10. CONSTRUCTION OPERATIONS SHALL BE CARRIED OUT IN SUCH A MANNER THAT EROSION AND WATER POLLUTION ARE MINIMIZED.11. THE STRUCTURE SHALL BE REMOVED AND THE AREA STABILIZED WHEN DRAINAGE AREA HAS BEEN PROPERLY STABILIZED.12. DRAINAGE AREA FOR THIS PRACTICE IS LIMITED TO 15 ACRES OR LESS.	
<p>ADAPTED FROM DETAILS PROVIDED BY: USDA - NRCS, NEW YORK STATE DEPARTMENT OF TRANSPORTATION, NEW YORK STATE DEPARTMENT OF ENVIRONMENTAL CONSERVATION, NEW YORK STATE SOIL & WATER CONSERVATION COMMITTEE</p>	<h3>RIPRAP OUTLET SEDIMENT TRAP ST-V</h3>

Figure 5A.21
Optional Sediment Trap Dewatering Devices



STANDARD AND SPECIFICATIONS FOR PORTABLE SEDIMENT TANK

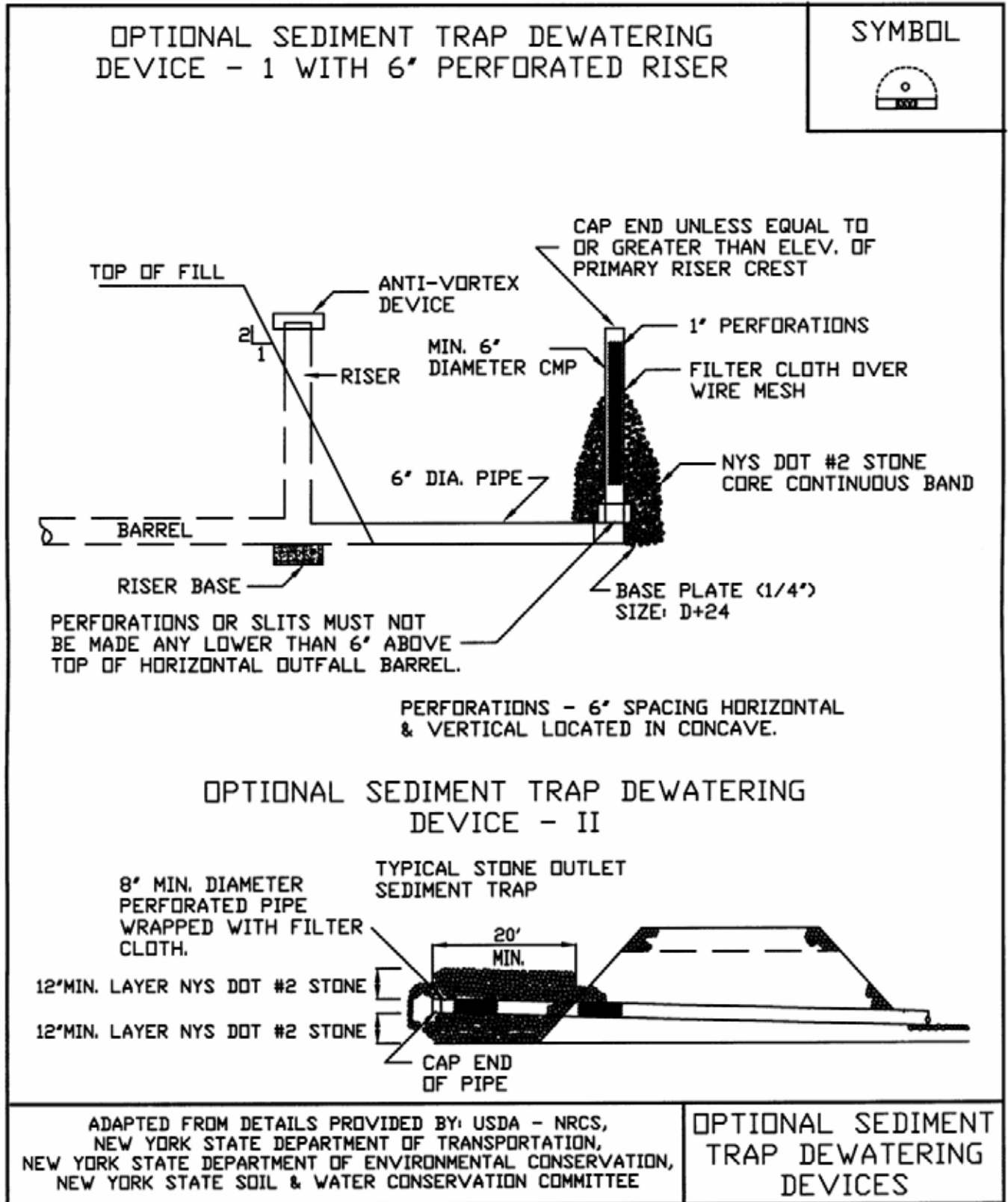

Definition

A sediment tank is a compartmented tank container to which sediment laden water is pumped to trap and retain the sediment.

Purpose

To trap and retain sediment prior to pumping the water to drainageways, adjoining properties, and rights-of-way below the sediment tank site.

Conditions Where Practice Applies

A sediment tank is to be used on sites where excavations are deep, and space is limited, such as urban construction, where direct discharge of sediment laden water to stream and storm drainage systems is to be avoided.

Design Criteria

Location

The sediment tank shall be located for ease of clean-out and disposal of the trapped sediment, and to minimize the interference with construction activities and pedestrian traffic.

Tank Size

The following formula should be used in determining the storage volume of the sediment tank; pump discharge (G.P.M.) x 16 = Cubic Foot Storage.

An example of a typical sediment tank is shown on Figure 5A.22 on page 5A.48. Other container designs can be used if the storage volume is adequate and approval is obtained from the local approving agency. Commercially manufactured tanks are also available.

Figure 5A.22
Portable Sediment Tank

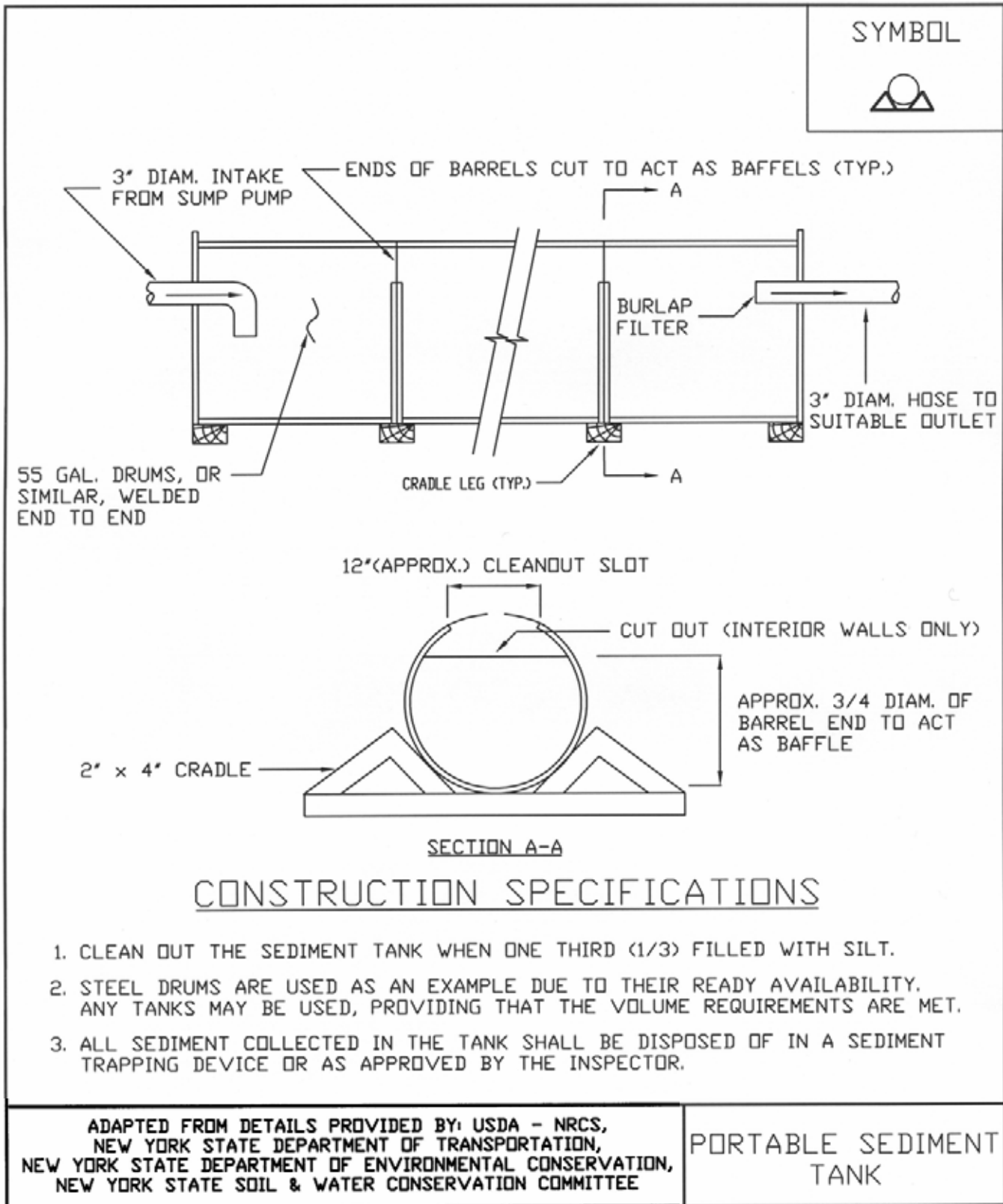

STANDARD AND SPECIFICATIONS FOR SEDIMENT BASIN



Class	1	2
Max. Drainage Area (acres)	100	100
Max. Height ¹ of Dam (ft.)	10	15
Min. Embankment Top Width	8	10
Embankment Side Slopes	2:1 or Flatter	2 ½:1 or Flatter
Anti-Seep Control Required	Yes	Yes

¹ Height is measured from the low point of original ground at the downstream toe of the dam to the top of the dam.

Definition

A temporary barrier or dam constructed across a drainage way or at other suitable locations to intercept sediment laden runoff and to trap and retain the sediment.

Scope

This standard applies to the installation of temporary sediment basins on sites where: (a) failure of the structure would not result in loss of life, damage to homes or buildings, or interruption of use or service of public roads or utilities; (b) the drainage area does not exceed 100 acres; and (c) the basin is to be removed within 36 months after the beginning of construction of the basin.

Permanent (to function more than 36 months) sediment basins, or temporary basins exceeding the classification requirements for class 1 and 2, or structures that temporarily function as a sediment basin but are intended for use as a permanent pool shall be classified as permanent structures and shall conform to criteria appropriate for permanent structures. These structures shall be designed and constructed to conform to NRCS Standard And Specification No. 378 for Ponds in the National Handbook of Conservation Practices and the New York State Department of Environmental Conservation, "Guidelines for the Design of Dams." The total volume of permanent sediment basins shall equal to or exceed the capacity requirements for temporary basins contained herein.

Classification of Temporary Sediment Basins

For the purpose of this standard, temporary sediment basins are classified as follows:

Purpose

The purpose of a sediment basin is to intercept sediment-laden runoff and reduce the amount of sediment leaving the disturbed area in order to protect drainage ways, properties, and rights-of-way below the sediment basin.

Conditions Where Practice Applies

A sediment basin is appropriate where physical site conditions or land ownership restrictions preclude the installation of other erosion control measures to adequately control runoff, erosion, and sedimentation. However, it is strongly encouraged to use a basin in addition to other ESC measures if practicable. It may be used below construction operations which expose critical areas to soil erosion. The basin shall be maintained until the disturbed area is protected against erosion by permanent stabilization.

Design Criteria

Compliance with Laws and Regulations

Design and construction shall comply with state and local laws, ordinances, rules and regulations, including permits.

Location

The sediment basin should be located to obtain the maximum storage benefit from the terrain and for ease of cleanout of the trapped sediment. It should be located to minimize interference with construction activities and

construction of utilities. Whenever possible, sediment basins should be located so that storm drains may outfall or be diverted into the basin. **Do not locate basins in perennial streams.**

Size and Shape of the Basin

The minimum sediment storage volume of the basin, as measured from the bottom of the basin to the elevation of the crest of the principal spillway shall be at least 3,600 cubic feet per acre draining to the basin. This 3,600 cubic feet is equivalent to one inch of sediment per acre of drainage area. The entire drainage area is used for this computation, rather than the disturbed area above, to maximize trapping efficiency. The length to width ratio shall be greater than 2:1, where length is the distance between the inlet and outlet. A wedge shape shall be used with the inlet located at the narrow end.

Surface Area

Recent studies (Barfield and Clar 1985; Pitt, 2003) indicate that the following relationship between surface area and peak inflow rate gives a trapping efficiency of 75% for silt loam soils, and greater than 90% for loamy sand soils:

$A = 0.01 Q_p$ or, $A = 0.015 \times D.A.$
(whichever is greater)
where,

A = the basin surface area, acres, measured at the service spillway crest; and

Q_p = the peak inflow rate for the design storm.
(The minimum design storm will be a 10 year, 24 hour storm under construction conditions).

D.A. = contributing drainage area.

One half of the design sediment storage volume (67 cubic yards per acre drainage area) shall be in the form of a permanent pool, and the remaining half as drawdown volume.

Sediment basins shall be cleaned out when the permanent pool volume remaining as described above is reduced by 50 percent, except in no case shall the sediment level be permitted to build up higher than one foot below the principal spillway crest. At this elevation, cleanout shall be performed to restore the original design volume to the sediment basin.

The elevation corresponding to the maximum allowable sediment level shall be determined and shall be stated in the design data as a distance below the top of the riser and shall be clearly marked on the riser.

The basin dimensions necessary to obtain the required basin volume as stated above shall be clearly shown on the plans to facilitate plan review, construction, and inspection.

Spillway Design

Runoff shall be computed by the method outlined in: Chapter 2, Estimating Runoff, Engineering Field Handbook available in the Natural Resources Conservation Service offices or, by TR-55, Urban Hydrology for Small Watersheds. **Runoff computations shall be based upon the worst soil cover conditions expected to prevail in the contributing drainage area during the anticipated effective life of the structure.** The combined capacities of the principal and emergency spillway shall be sufficient to pass the peak rate of runoff from a ten-year frequency storm.

1. Principal spillway: A spillway consisting of a vertical pipe or box type riser joined (watertight connection) to a pipe (barrel) which shall extend through the embankment and outlet beyond the downstream toe of the fill. The minimum capacity of the principal spillway shall be 0.2 cfs per acre of drainage area when the water surface is at the emergency spillway crest elevation. For those basins with no emergency spillway, the principal spillway shall have the capacity to handle the peak flow from a ten-year frequency rainfall event. The minimum size of the barrel shall be 8 inches in diameter. See Figures 5A.25, 5A.26, and 5A.27 on pages 5A.60, 5A.61, and 5A.62 for principal spillway sizes and capacities.

A. Crest elevation: When used in combination with an emergency spillway, the crest elevation of the riser shall be a minimum one foot below the elevation of the control section of the emergency spillway.

B. Watertight riser and barrel assembly: The riser and all pipe connections shall be completely watertight except for the inlet opening at the top, or a dewatering opening. There shall not have any other holes, leaks, rips, or perforations in the structure.

C. Dewatering the basin: The drawdown volume will be discharged over a 10 hour period. The size of the orifice to provide this control can be approximated as follows:

$$A_o = \frac{A_s \times 2h^{0.5}}{T \times C_d \times 20,428} \quad \text{therefore,} \quad A_o = \frac{A_s \times 2h^{0.5}}{122,568}$$

where,

A_o = surface area of the dewatering orifice

A_s = surface area of the basin

h = head of water above orifice

C_d = coefficient of contraction for an orifice (0.6)

T = detention time needed to dewater the basin (10 hours)

D. Anti-vortex device and trash rack: An anti-vortex device and trash rack shall be securely installed on top of the riser and shall be the concentric type as shown in Figure 5A.29(1) and 5A.29(2) on pages 5A.64 and 5A.65.

E. Base: The riser shall have a base attached with a

watertight connection and shall have sufficient weight to prevent flotation of the riser. Two approved bases for risers ten feet or less in height are: 1) a concrete base 18 in. thick with the riser embedded 9 in. in the base, and 2) a ¼" minimum thickness steel plate attached to the riser by a continuous weld around the circumference of the riser to form a watertight connection. The plate shall have 2.5 feet of stone, gravel, or compacted earth placed on it to prevent flotation. In either case, each side of the square base shall be twice the riser diameter.

For risers greater than ten feet high, computations shall be made to design a base which will prevent flotation. The minimum factor of safety shall be 1.20 (Downward forces = 1.20 x upward forces). See Figure 5A.30 on page 5A.66 for details.

F. Anti-Seep Collars: Anti-seep collars shall be installed around all conduits through earth fills of impoundment structures according to the following criteria:

- 1) Collars shall be placed to increase the seepage length along the conduit by a minimum of 15 percent of the pipe length located within the saturation zone.
- 2) Collar spacing shall be between 5 and 14 times the vertical projection of each collar.
- 3) All collars shall be placed within the saturation zone.
- 4) The assumed normal saturation zone (phreatic line) shall be determined by projecting a line at a slope of 4 horizontal to 1 vertical from the point where the normal water (riser crest) elevation touches the upstream slope of the fill to a point where this line intersects the invert of the pipe conduit. All fill located within this line may be assumed as saturated.

When anti-seep collars are used, the equation for revised seepage length becomes:

$$2(N)(P)=1.15(L_s) \text{ or,} \\ N=(0.075)(L_s)/P$$

Where: L_s = Saturated length is length, in feet, of pipe between riser and intersection of phreatic line and pipe invert.

N = number of anti-seep collars.

P = vertical projection of collar from pipe, in feet.

- 5) All anti-seep collars and their connections shall

be watertight.

See Figure 5A.31(1) and 5A.31(2) on pages 5A.67 and 5A.68 for anti-seep collar design and Figure 5A.32 on page 5A.69 for construction details. Seepage diaphragms may be used in lieu of anti-seep collars. They shall be designed in accordance to USDA NRCS Pond Standard 378.

G. Outlet: An outlet shall be provided, including a means of conveying the discharge in an erosion free manner to an existing stable channel. Where discharge occurs at the property line, drainage easements will be obtained in accordance with local ordinances. Adequate notes and references will be shown on the erosion and sediment control plan.

Protection against scour at the discharge end of the pipe spillway shall be provided. Measures may include basin, riprap, revetment, excavated plunge pools, or other approved methods. See Standard and Specification for Rock Outlet Protection, page 5B.21.

2. Emergency Spillways: The entire flow area of the emergency spillway shall be constructed in undisturbed ground (not fill). The emergency spillway cross-section shall be trapezoidal with a minimum bottom width of eight feet. This spillway channel shall have a straight control section of at least 20 feet in length; and a straight outlet section for a minimum distance equal to 25 feet.

A. Capacity: The minimum capacity of the emergency spillway shall be that required to pass the peak rate of runoff from the 10 year 24-hour frequency storm, less any reduction due to flow in the pipe spillway. Emergency spillway dimensions may be determined by using the method described in Figure 5A.33 on page 5A.70.

B. Velocities: The velocity of flow in the exit channel shall not exceed 5 feet per second for vegetated channels. For channels with erosion protection other than vegetation, velocities shall be within the non-erosive range for the type of protection used.

C. Erosion Protection: Erosion protection shall be provided for by vegetation as prescribed in this publication or by other suitable means such as riprap, asphalt or concrete.

D. Freeboard: Freeboard is the difference between the design high water elevation in the emergency spillway and the top of the settled embankment. If there is no emergency spillway, it is the difference between the water surface elevation required to pass the design flow through the pipe and the top of the settled embankment. Freeboard shall be at least one foot.

Embankment Cross-Section

Class 1 Basins: The minimum top width shall be eight feet. The side slopes shall not be steeper than 2:1.

Class 2 Basins: The minimum top width shall be ten feet. The side slopes shall not be steeper than 2 ½:1.

Entrance of Runoff into Basin

Points of entrance of surface runoff into excavated sediment basins shall be protected to prevent erosion. Considerable care should be given to the major points of inflow into basins. In many cases the difference in elevation of the inflow and the bottom of the basin is considerable, thus creating a potential for severe gullying and sediment generation. Often a riprap drop at major points of inflow would eliminate gullying and sediment generation.

Diversions, grade stabilization structures or other water control devices shall be installed as necessary to ensure direction of runoff and protect points of entry into the basin. Points of entry should be located so as to ensure maximum travel distance of entering runoff to point of exit (the riser) from the basin.

Disposal

The sediment basin plans shall indicate the method(s) of disposing of the sediment removed from the basin. The sediment shall be placed in such a manner that it will not erode from the site. The sediment shall not be deposited downstream from the basin, adjacent to a stream or floodplain. Disposal sites will be covered by an approved sediment control plan.

The sediment basin plans shall also show the method of disposing of the sediment basin after the drainage area is stabilized, and shall include the stabilization of the sediment basin site. Water contained within the storage areas shall be removed from the basin by pumping, cutting the top of the riser, or other appropriate method prior to removing or breaching the embankment. Sediment shall not be allowed to flush into a stream or drainage way.

Chemical Treatment

Precipitation of sediment is enhanced with the use of specific chemical flocculants that can be applied to the sediment basin in liquid, powder, or solid form. Flocculants include polyacrylamides, aluminum sulfate (alum), and polyaluminum chloride. Cationic polyelectrolytes have a greater toxicity to fish and other aquatic organisms than anionic polyelectrolytes because they bind to the gills of fish resulting in respiratory failure (Pitt, 2003).

Chemical treatment shall not be substituted for proper erosion and sediment control. To reduce the need for flocculants, proper controls include planning, phasing, sequencing and practice design in accordance to NY

Standards. Chemical applications shall not be applied without written approval from the NYSDEC.

Safety

Sediment basins are attractive to children and can be very dangerous. Local ordinances and regulations must be adhered to regarding health and safety. The developer or owner shall check with local building officials on applicable safety requirements. If fencing of sediment basins is required, the location of and type of fence shall be shown on the plans.

Construction Specifications

Site Preparation

Areas under the embankment shall be cleared, grubbed, and stripped of topsoil to remove trees, vegetation, roots, or other objectionable material. In order to facilitate cleanout and restoration, the pool area (measured at the top of the pipe spillway) will be cleared of all brush, trees, and other objectionable materials.

Cutoff-Trench

A cutoff trench shall be excavated along the centerline of earth fill embankments. The minimum depth shall be two feet. The cutoff trench shall extend up both abutments to the riser crest elevation. The minimum bottom width shall be four feet, but wide enough to permit operation of excavation and compaction equipment. The side slopes shall be no steeper than 1:1. Compaction requirements shall be the same as those for embankment. The trench shall be dewatered during the back-filling/compaction operations.

Embankment

The fill material shall be taken from approved areas shown on the plans. It shall be clean mineral soil free of roots, woody vegetation, oversized stones, rocks, or other objectionable material. Relatively pervious materials such as sand or gravel (Unified Soil Classes GW, GP, SW & SP) shall not be placed in the embankment. Areas on which fill is to be placed shall be scarified prior to placement of fill. The fill material shall contain sufficient moisture so that it can be formed by hand into a ball without crumbling. If water can be squeezed out of a ball, it is too wet for proper compaction. Fill material shall be placed in six to eight-inch thick continuous layers over the entire length of the fill. Compaction shall be obtained by routing and hauling the construction equipment over the fill so that the entire surface of each layer of the fill is traversed by at least one wheel or tread track of the equipment or by the use of a compactor. The embankment shall be constructed to an elevation 10 percent higher than the design height to allow for settlement.

Pipe Spillway

The riser shall be securely attached to the barrel or barrel stub by welding the full circumference making a watertight structural connection. The barrel stub must be attached to the riser at the same percent (angle) of grade as the outlet conduit. The connection between the riser and the riser base shall be watertight. All connections between barrel sections must be achieved by approved watertight bank assemblies. The barrel and riser shall be placed on a firm, smooth foundation of impervious soil. Pervious materials such as sand, gravel, or crushed stone shall not be used as backfill around the pipe or anti-seep collars. The fill material around the pipe spillway shall be placed in four-inch layers and compacted under and around the pipe to at least the same density as the adjacent embankment.

A minimum depth of two feet of hand compacted backfill shall be placed over the pipe spillway before crossing it with construction equipment. Steel base plates on risers shall have at least 2 ½ feet of compacted earth, stone, or gravel placed over it to prevent flotation.

Emergency Spillway

The emergency spillway shall be installed in undisturbed ground. The achievement of planned elevations, grades, design width, entrance and exit channel slopes are critical to the successful operation of the emergency spillway and must be constructed within a tolerance of +/- 0.2 feet.

Vegetative Treatment

Stabilize the embankment and emergency spillway in accordance with the appropriate vegetative standard and specification immediately following construction. In no case shall the embankment remain unstabilized for more than seven (7) days.

Erosion and Pollution Control

Construction operations shall be carried out in such a manner that erosion and water pollution will be minimized. State and local laws shall be complied with concerning pollution abatement.

Safety

State and local requirements shall be met concerning fencing and signs, warning the public of hazards of soft sediment and floodwater.

Maintenance

1. Repair all damages caused by soil erosion and construction equipment at or before the end of each working day.

2. Sediment shall be removed from the basin when it reaches the specified distance below the top of the riser (shall not exceed 50 percent capacity). This sediment shall be placed in such a manner that it will not erode from the site. The sediment shall not be deposited downstream from the embankment, adjacent to a stream or floodplain.

Final Disposal

When temporary structures have served their intended purpose and the contributing drainage area has been properly stabilized, the embankment and resulting sediment deposits are to be leveled or otherwise disposed of in accordance with the approved sediment control plan. The proposed use of a sediment basin site will often dictate final disposition of the basin and any sediment contained therein. If the site is scheduled for future construction, then the basin material and trapped sediments must be removed, safely disposed of, and backfilled with a structural fill. When the basin area is to remain open space, the pond may be pumped dry, graded, and back filled.

Information to be Submitted

Sediment basin designs and construction plans submitted for review to a local municipality, Soil and Water Conservation District, or other agency shall include the following:

1. Specific location of the basin.
2. Plan view of the storage basin and emergency spillway, showing existing and proposed contours.
3. Cross section of dam, principal spillway, emergency spillway, and profile of emergency spillway.
4. Details of pipe connections, riser to pipe connections, riser base, anti-seep control, trash rack cleanout elevation, and anti-vortex device.
5. Runoff calculations for 1 and 10-year frequency storms, if required.
6. Storage Computation
 - A. Total required
 - B. Total Available
 - C. Level of sediment at which cleanout shall be required; to be stated as a distance from the riser crest to the sediment surface.
7. Calculations showing design of pipe and emergency spillway.

Note: Items 5 through 7 above may be submitted using the design data sheet on pages 7A.54 through 7A.59.

TEMPORARY SEDIMENT BASIN DESIGN DATA SHEET

Computed by _____ Date _____ Checked by _____ Date _____
Project _____ Basin # _____
Location _____ Total Area draining to basin _____ Acres

BASIN SIZE DESIGN

1. Minimum sediment storage volume = 134 cu. yds. x _____ acres of drainage area = _____ cu.yds.
2. a. Cleanout at 50 percent of minimum required volume = _____ cu. yds.
b. Elevation corresponding to scheduled time to clean out _____
c. Distance below top of riser _____ feet
3. Minimum surface area is larger of $0.01 Q_{(1)}$ _____ or, $0.015 DA$ = _____ use _____ acres

DESIGN OF SPILLWAYS & ELEVATIONS

Runoff

4. $Q_{p(10)}$ = _____ cfs
(EFH, Ch. 2, TR-55, or Section 4; Attach runoff computation sheet)

Pipe Spillway (Q_{ps})

5. Min. pipe spillway cap., $Q_{ps} = 0.2 \times$ _____ ac. Drainage = _____ cfs
Note: If there is no emergency spillway, then req'd $Q_{ps} = Q_{p(10)}$ = _____ cfs.
6. H = _____ ft. Barrel length = _____ ft
7. Barrel: Diam. _____ inches; $Q_{ps} = (Q)$ _____ x (cor.fac.) _____ = _____ cfs.
8. Riser: Diam. _____ inches; Length _____ ft.; h = _____ ft. Crest Elev. _____
9. Trash Rack: Diam. _____ inches; H = _____ inches

Emergency Spillway Design

10. Emergency Spillway Flow, $Q_{es} = Q_p - Q_{ps} =$ _____ - _____ = _____ cfs.
11. Width _____ ft.; H_p _____ ft. Crest elevation _____; Design High Water Elev. _____
Entrance channel slope _____ % ; Top of Dam Elev. _____
Exit channel slope _____ %

ANTI-SEEP COLLAR/ SEEPAGE DIAPHRAGM DESIGN

Collars:

12. y = _____ ft.; z = _____ :1; pipe slope = _____ %, $L_s =$ _____ ft.
Use _____ collars, _____ - _____ inches square; projection = _____ ft.

Diaphragms:

_____ width _____ ft. height _____ ft.

DEWATERING ORIFICE SIZING

13. $A_o = \frac{A_s \times (2h)^{0.5}}{122,568}$ = _____ sq. ft.; h = _____ ft.; therefore use, _____

TEMPORARY SEDIMENT BASIN DESIGN DATA SHEET

INSTRUCTIONS FOR USE OF FORM

1. Minimum required sediment storage volume is 134 cubic yards (3600 cubic feet) per acre from each acre of drainage area. Values larger than 134 cubic yards per acre may be used for greater protection. Compute volume using entire drainage area although only part may be disturbed.
2. The volume of a naturally shaped basin (no excavation in basin) may be approximated by the formula $V = (0.4)(A)(d)$, where V is in cubic feet, A is the surface area of the basin, in square feet, and d is the maximum depth of the basin, in feet. Volume may be computed from contour information or other suitable methods.
3. If volume of basin is not adequate for required storage, excavate to obtain the required volume.
4. The minimum surface area of the basin pool at the storage volume elevation will be the larger of the two elevations shown.
5. USDA-NRCS TR-55 or the NRCS Engineering Field Handbook, Chapter 2, are the preferred methods for runoff computation. Runoff curve numbers will be computed for the drainage area that reflects the maximum construction condition.
6. Required minimum discharge from pipe spillway equals 0.2 cfs/ac. times total drainage area. (This is equivalent to a uniform runoff of 5 in. per 24 hours). The pipe shall be designed to carry Q_p if site conditions preclude installation of an emergency spillway to protect the structure.
7. Determine value of "H" from field conditions; "H" is the interval between the centerline of the outlet pipe and the emergency spillway crest, or if there is no emergency spillway, to the design high water.
8. See Pipe Spillway Design Charts, Figures 5A.26 and 5A.27 on pages 5A.61 and 5A.62.
9. See Riser Inflow Curves, Figure 5A.25 on page 5A.60.
10. Compute the orifice size required to dewater the basin over a 10 hour period.
11. See Trash Rack and Anti-Vortex Device Design, Figures 5A.29 on pages 5A.64 and 5A.65.
12. Compute Q_{es} by subtracting actual flow carried by the pipe spillway from the total inflow, Q_p .
13. Use appropriate tables to obtain values of H_p , bottom width, and actual Q_{es} . If no emergency spillway is to be used, so state, giving reason(s).
14. See Anti-Seep Collar / Seepage Diaphragm Design.
15. Fill in design elevations. The emergency spillway crest must be set no closer to riser crest than value of h , which causes pipe spillway to carry the minimum, required Q . Therefore, the elevation difference between spillways shall be equal to the value of h , or one foot, whichever is greater. Design high water is the elevation of the emergency spillway crest plus the value of H_p , or if there is no emergency spillway, it is the elevation of the riser crest plus h required to handle the 10-year storm. Minimum top of dam elevation requires 1.0 ft. of freeboard above design high water.

Pipe Spillway Design

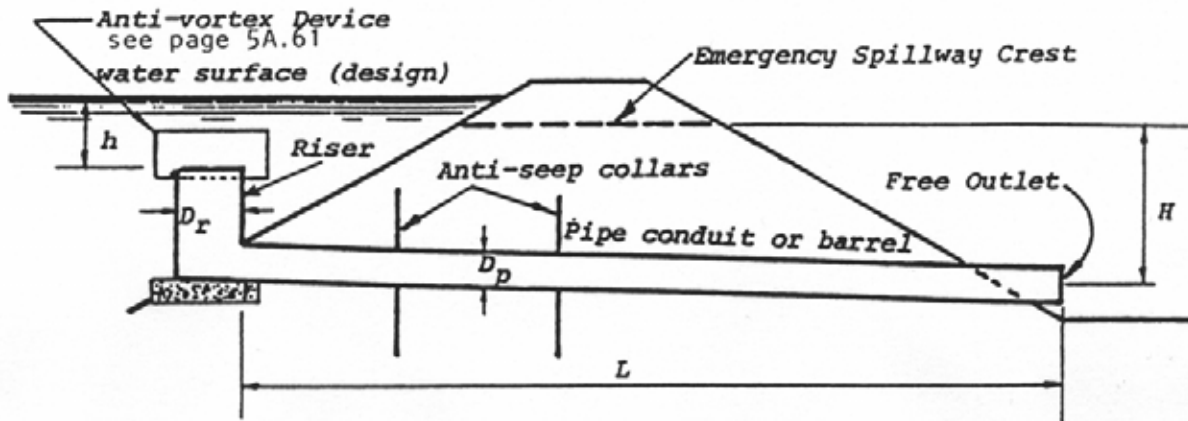

H = Head on pipe spillway (pipe flow), ft. (centerline of outlet to emergency spillway crest or to design high water if no emergency spillway)

h = Head over riser crest, ft.

L = Length of pipe in ft.

D_p = Diameter of pipe conduit (barrel)

D_r = Diameter of riser

To use charts for pipe spillway design:

- Enter chart, Figures 5A.26 and 5A.27 on Pages 5A.61 and 5A.62 with H and required discharge.
- Find diameter of pipe conduit that provides equal or greater discharge
- Enter chart, Figure 5A.25 on Page 5A.60 with actual pipe discharge. Read across to select smallest riser that provides discharge within weir flow portion of rating curve. Read down to find corresponding h required. This h must be 1 foot or less.

Example:

Given: Q (required) = 5.8 cfs, L = 60 ft., H = 9 ft. to centerline of pipe = Free outlet

Find: Pipe size, actual Q and size of riser, use corrugated metal pipe, n = 0.025

Q of 12 in. pipe = 5.95 cfs \times (correction factor) 1.07 = 6.4 cfs from the Pipe Flow Chart. From Riser Inflow Curves (Figures 5A.25 on page 5A.60), smallest riser = 18 in. (@ h = 0.60).

Design Example #1

(see Page 5A.58).

Snooks Pond is a senior citizen assisted living center under construction. A sediment basin will be utilized as a component of the erosion and sediment control plan for the project. The Drainage area to the basin is 20 acres, the one year storm peak discharge is 32 cubic feet per second, and 88 cfs for the 10 year storm based on analysis of the site under maximum construction condition. Design the sediment basin when the overall head (H) is 10 feet and the smooth steel pipe spillway is used. An emergency spillway can be constructed on the site. Base the design volumes and elevations on the stage storage curve developed for the natural topography or as excavated

Design Example # 2

Use the same data as example #1, but no emergency spillway is possible (see Page 7A. 59).

Notes:

1. Use a 1.0 foot minimum between riser crest and emergency spillway crest, thus riser crest = 1.0 ft.
2. To provide 50% of the storage as permanent pool, the dewatering orifice is set at the out elevation.

**Figure 5A.23
Sediment Basin**

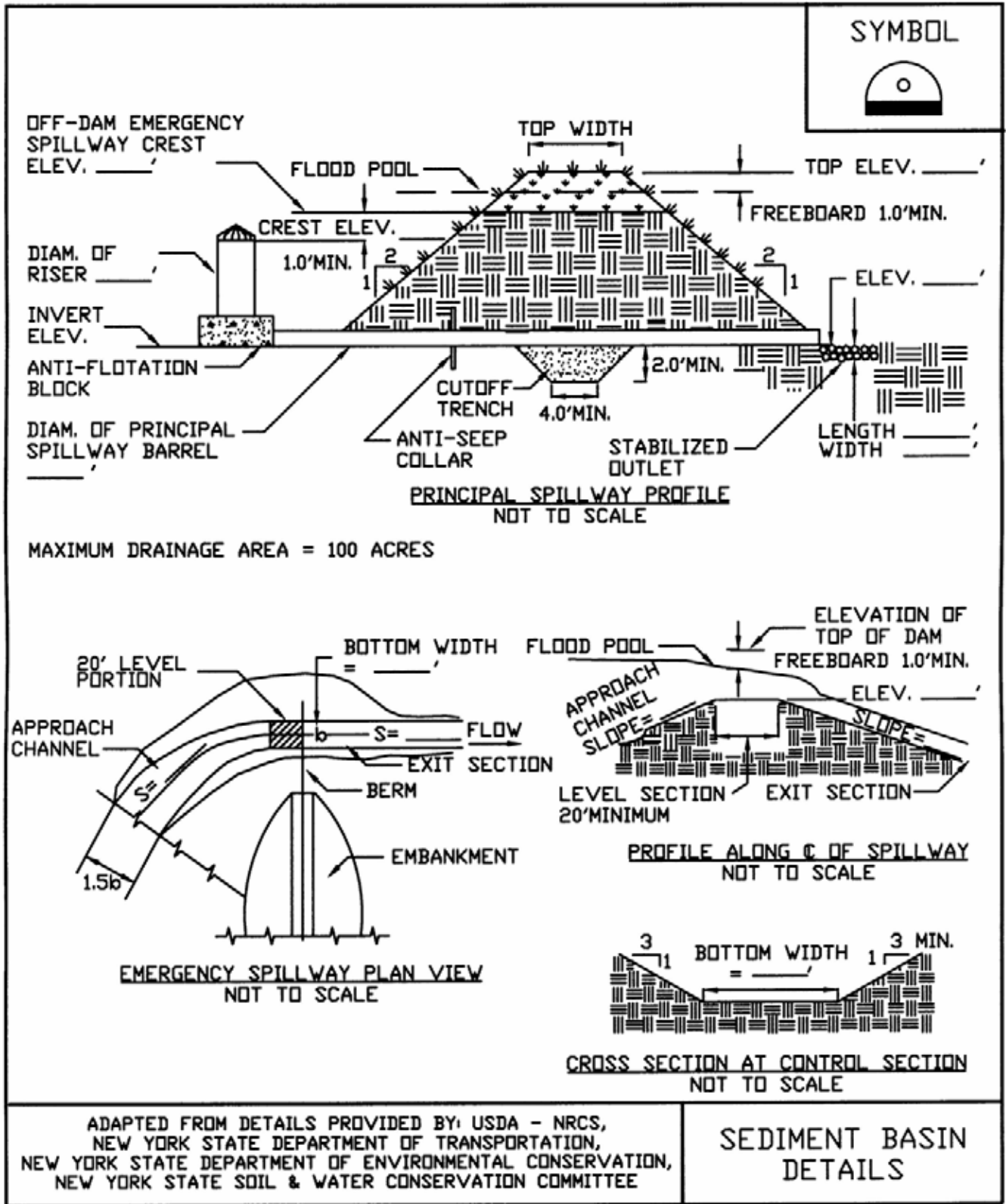

Figure 5A.24(1) Sediment Basin Design Example #1

TEMPORARY SEDIMENT BASIN DESIGN DATA SHEET

Computed by DWL Date 1-04 Checked by PLS Date 1-04
 Project SNOOKS POND Basin # 1
 Location MANLIUS, NY Total Area draining to basin 20 Acres

BASIN SIZE DESIGN

1. Minimum sediment storage volume = 134 cu. yds. x 20 acres of drainage area = 2,680 cu. yds.
2. a. Cleanout at 50 percent of minimum required volume = 1,340 cu. yds.
 b. Elevation corresponding to scheduled time to clean out 96.5
 c. Distance below top of riser 3.5 Ft.
3. Minimum surface area is larger of $0.01 Q_{(1)}$ 0.32 or, $0.015 DA$ = 0.30 use 0.32 Acres

DESIGN OF SPILLWAYS & ELEVATIONS

Runoff

4. $Q_{p(10)}$ = 88 cfs
 (EFH, Ch. 2, TR-55, or Section 4; Attach runoff computation sheet)

Pipe Spillway (Q_{ps})

5. Min. pipe spillway cap., $Q_{ps} = 0.2 \times$ 20 ac. Drainage = 4 cfs
 Note: If there is no emergency spillway, then req'd $Q_{ps} = Q_{p(10)}$ = 88 cfs.
6. $H =$ 10 ft. Barrel length = 85 ft
7. Barrel: Diam. 12 inches; $Q_{ps} = (Q)$ 10.2 x (cor.fac.) .945 = 9.6 cfs.
8. Riser: Diam. 21 inches; Length 9 ft.; $h =$ 1.0 ft. Crest Elev. 100.0
9. Trash Rack: Diam. 30 inches; $H =$ 11 inches

Emergency Spillway Design

10. Emergency Spillway Flow, $Q_{es} = Q_p - Q_{ps} =$ 88 - 10 = 78 cfs.
11. Width 20 ft.; H_p 1.4 ft. Crest elevation 101.0; Design High Water Elev. 102.4
 Entrance channel slope 2 %; Top of Dam Elev. 103.4
 Exit channel slope > 2.7 %

ANTI-SEEP COLLAR/

SEEPAGE DIAPHRAGM DESIGN

Collars:

12. $y =$ 8 ft.; $z =$ 2 :1; pipe slope = 1 %, $L_s =$ 50 ft.
 Use 2 collars, 4' - 6" inches square; projection = 1.8 ft.

Diaphragms:

1 width 7 ft. height 10 ft.

DEWATERING ORIFICE SIZING

13. $A_o = \frac{A_s \times (2h)^{0.5}}{122,568} =$ 0.30 sq. ft.; $h =$ 3.5 ft.; therefore use, 7.4" → USE 6" orifice

Figure 5A.24(2) Sediment Basin Design Example #2

TEMPORARY SEDIMENT BASIN DESIGN DATA SHEET

Computed by DWL Date 1-04 Checked by PLS Date 1-04
 Project SNOOKS POND Basin # 1
 Location MANLIUS, NY Total Area draining to basin 20 Acres

BASIN SIZE DESIGN

1. Minimum sediment storage volume = 134 cu. yds. x 20 acres of drainage area = 2,680 cu. yds.
2. a. Cleanout at 50 percent of minimum required volume = 1,340 cu. yds.
 b. Elevation corresponding to scheduled time to clean out 96.5
 c. Distance below top of riser 3.5 feet
3. Minimum surface area is larger of 0.01 $Q_{(1)}$ 0.32 or, 0.015 DA = 0.30 use 0.32 acres

DESIGN OF SPILLWAYS & ELEVATIONS

Runoff

4. $Q_{p(10)}$ = 88 cfs
 (EFH, Ch. 2, TR-55, or Section 4; Attach runoff computation sheet)

Pipe Spillway (Q_{ps})

5. Min. pipe spillway cap., $Q_{ps} = 0.2 \times$ 20 ac. Drainage = 4 cfs
 Note: If there is no emergency spillway, then req'd $Q_{ps} = Q_{p(10)} =$ 88 cfs.
6. H = 10 ft. Barrel length = 85 ft
7. Barrel: Diam. 36 inches; $Q_{ps} = (Q)$ 91.2 x (cor. fac.) .955 = 87.1 cfs.
8. Riser: Diam. 54 inches; Length 9 ft.; h = 1.7 ft. Crest Elev. 100.0
9. Trash Rack: Diam. 78 inches; H = 25 inches

Emergency Spillway Design

10. Emergency Spillway Flow, $Q_{es} = Q_p - Q_{ps} =$ _____ - _____ = _____ cfs.
11. Width _____ ft.; H_p _____ ft. Crest elevation _____; Design High Water Elev. _____
 Entrance channel slope _____ %; Top of Dam Elev. _____
 Exit channel slope _____ %

ANTI-SEEP COLLAR/ SEEPAGE DIAPHRAGM DESIGN

Collars:

12. y = 8 ft.; z = 2 :1; pipe slope = 1 %, $L_s =$ 50 ft.
 Use 2 collars, 4' - 6 inches square; projection = 1.8 ft.

Diaphragms:

1 width 7 ft. height 10 ft.

DEWATERING ORIFICE SIZING

13. $A_o = \frac{A_s \times (2h)^{0.5}}{122,568} =$ 0.30 sq. ft.; h = 3.5 ft.; therefore use, 7.4" → USE 6" orifice

Figure 5A.25
Riser Inflow Chart (USDA - NRCS)

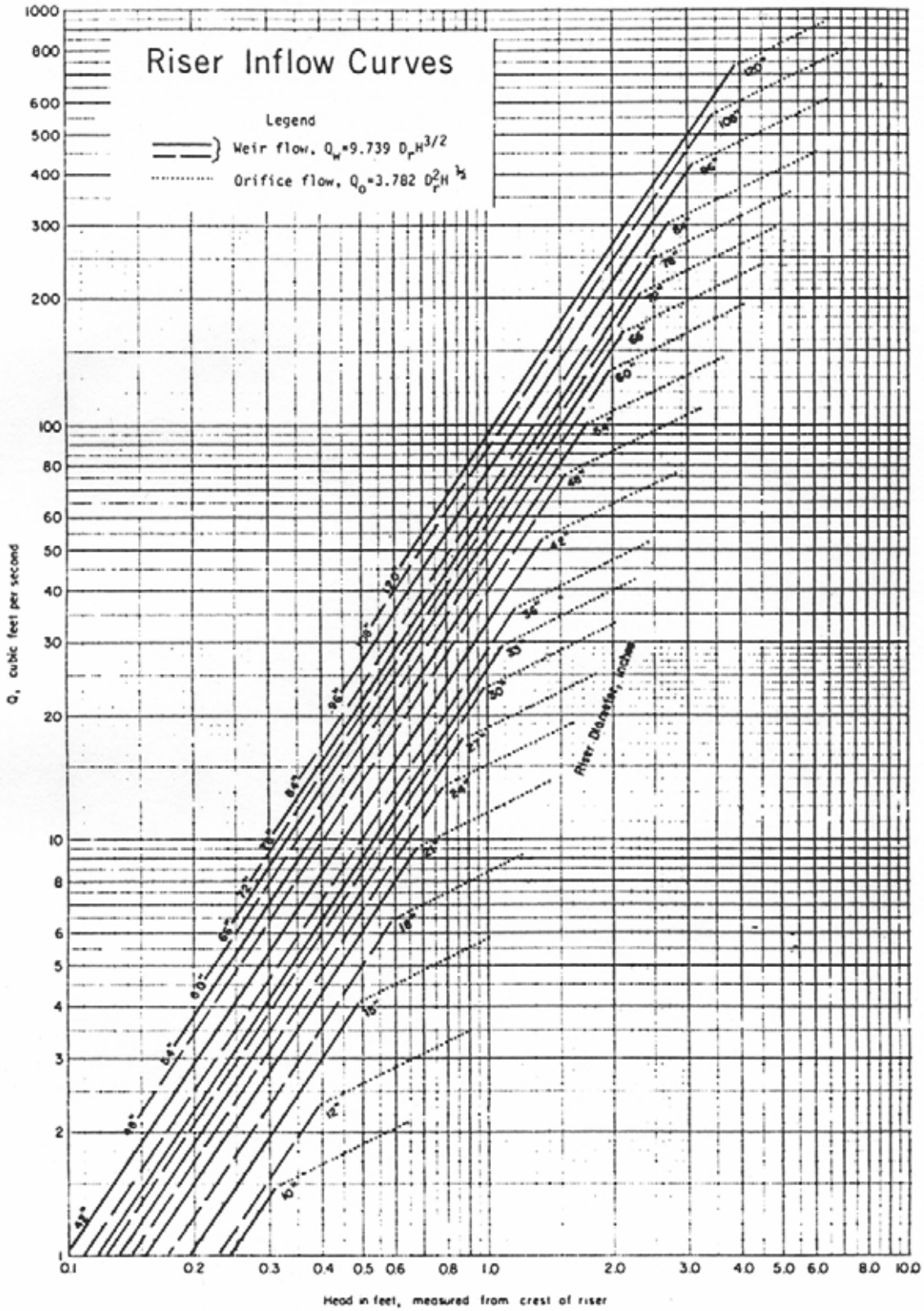

Figure 5A.26
Pipe Flow Chart; "n" = 0.025 (USDA - NRCS)

PIPE FLOW CHART n = 0.025
 FOR CORRUGATED METAL PIPE INLET $K_a + K_b = K_a + K_b = 1.0$ AND 70 FEET OF CORRUGATED METAL PIPE CONDUIT (full flow assumed)
 Note correction factors for pipe lengths other than 70 feet
 diameter of pipe in inches

H, in feet	6"	8"	10"	12"	15"	18"	21"	24"	30"	36"	42"	48"	54"	60"	66"	72"	78"	84"	90"	96"	102"
1	0.33	0.70	1.25	1.98	3.46	5.47	7.99	11.0	18.8	28.8	41.1	55.7	72.6	91.8	111	137	163	191	222	255	290
2	0.47	0.99	1.76	2.80	4.92	7.74	11.3	15.6	26.6	40.8	58.2	78.8	103	130.8	160	194	231	271	314	360	410
3	0.58	1.22	2.16	3.43	6.02	9.48	13.8	19.1	32.6	49.9	71.2	96.5	126	159	196	237	282	331	384	441	502
4	0.67	1.40	2.49	3.97	6.96	10.9	16.0	22.1	37.6	57.7	82.3	111	145	184	226	274	326	383	444	510	580
5	0.74	1.57	2.79	4.41	7.78	12.2	17.9	24.7	42.1	64.5	92.0	125	162	205	253	306	365	428	496	570	648
6	0.82	1.72	3.05	4.86	8.52	13.4	19.6	27.0	46.1	70.6	101	136	178	225	277	336	399	469	544	624	710
7	0.88	1.86	3.30	5.25	9.20	14.5	21.1	29.2	49.8	76.3	109	147	192	243	300	362	431	506	587	674	767
8	0.94	1.99	3.53	5.61	9.84	15.5	22.6	31.2	53.2	81.5	116	158	205	260	320	388	461	541	628	721	820
9	1.00	2.11	3.74	5.95	10.4	16.4	24.0	33.1	56.4	86.5	123	167	218	275	340	411	489	574	666	764	870
10	1.05	2.22	3.94	6.27	11.0	17.3	25.3	34.9	59.5	91.2	130	176	230	290	358	433	516	605	702	806	917
11	1.10	2.33	4.13	6.50	11.5	18.2	26.5	36.6	62.4	95.6	136	185	241	304	376	454	541	635	736	845	962
12	1.15	2.43	4.32	6.87	12.1	19.0	27.7	38.2	65.2	99.9	142	193	252	318	392	475	565	663	769	883	1004
13	1.20	2.53	4.49	7.15	12.6	19.7	28.8	39.8	67.8	104	148	201	262	331	408	494	589	690	800	919	1045
14	1.25	2.63	4.66	7.42	13.0	20.5	29.9	41.3	70.4	108	154	208	272	343	424	513	610	716	830	953	1085
15	1.29	2.72	4.83	7.60	13.5	21.2	30.9	42.8	72.8	112	159	216	281	355	439	531	631	741	860	987	1123
16	1.33	2.81	4.99	7.73	13.9	21.9	32.0	44.2	75.2	115	165	223	290	367	453	548	652	765	888	1019	1160
17	1.37	2.90	5.14	8.18	14.3	22.6	32.9	45.5	77.5	119	170	230	299	378	467	565	672	789	915	1051	1195
18	1.41	2.98	5.29	8.41	14.8	23.2	33.9	46.8	79.8	120	174	236	308	389	480	581	692	812	942	1081	1230
19	1.45	3.06	5.43	8.64	15.2	23.9	34.8	48.1	82.0	126	179	243	316	400	494	597	711	834	967	1111	1264
20	1.49	3.14	5.57	8.87	15.6	24.5	35.7	49.4	84.1	129	184	249	325	410	506	613	729	856	993	1139	1297
21	1.53	3.22	5.71	9.09	15.9	25.1	36.6	50.6	86.2	132	188	255	333	421	519	628	747	877	1017	1168	1329
22	1.56	3.29	5.85	9.30	16.3	25.7	37.5	51.8	88.2	135	193	261	341	430	531	643	765	898	1041	1195	1360
23	1.60	3.37	5.98	9.51	16.7	26.2	38.3	53.0	90.2	138	197	267	348	440	543	657	782	918	1064	1222	1390
24	1.63	3.44	6.11	9.72	17.0	26.8	39.1	54.1	92.1	141	201	273	356	450	555	671	799	937	1087	1248	1420
25	1.66	3.51	6.23	9.92	17.4	27.4	39.9	55.2	94.0	144	206	279	363	459	566	685	815	957	1110	1274	1450
26	1.70	3.58	6.36	10.1	17.7	27.9	40.7	56.3	95.9	147	210	284	370	468	577	699	831	976	1132	1299	1478
27	1.73	3.65	6.48	10.3	18.1	28.4	41.5	57.4	97.7	150	214	290	377	477	588	712	847	994	1153	1324	1507
28	1.76	3.72	6.60	10.5	18.4	28.9	42.3	58.4	99.5	153	218	295	384	486	599	725	863	1013	1174	1348	1534
29	1.79	3.78	6.71	10.7	18.7	29.5	43.0	59.5	101	155	221	300	391	494	610	738	878	1030	1195	1372	1561
30	1.82	3.85	6.83	10.9	19.1	30.0	43.7	60.5	103	158	225	305	398	503	620	750	893	1048	1216	1396	1588

L, in feet	20	30	40	50	60	70	80	90	100	120	140	160
20	1.69	1.63	1.58	1.53	1.47	1.42	1.37	1.34	1.28	1.24	1.20	1.18
30	1.44	1.41	1.39	1.36	1.32	1.29	1.27	1.24	1.21	1.18	1.15	1.13
40	1.26	1.27	1.25	1.23	1.21	1.20	1.18	1.17	1.14	1.12	1.11	1.10
50	1.16	1.16	1.15	1.14	1.13	1.12	1.11	1.10	1.09	1.08	1.07	1.06
60	1.07	1.07	1.07	1.06	1.06	1.05	1.05	1.05	1.04	1.04	1.04	1.04
70	1.00	1.00	1.00	1.00	1.00	1.00	1.00	1.00	1.00	1.00	1.00	1.00
80	0.94	0.94	0.95	0.95	0.95	0.96	0.96	0.96	0.96	0.96	0.96	0.96
90	0.89	0.89	0.90	0.90	0.91	0.91	0.92	0.92	0.93	0.94	0.94	0.94
100	0.85	0.85	0.86	0.86	0.87	0.88	0.89	0.89	0.90	0.91	0.92	0.93
120	0.78	0.79	0.80	0.81	0.82	0.83	0.83	0.83	0.85	0.86	0.87	0.89
140	0.72	0.73	0.74	0.75	0.76	0.77	0.78	0.79	0.81	0.82	0.84	0.85
160	0.68	0.69	0.70	0.71	0.73	0.74	0.75	0.77	0.79	0.80	0.82	0.83

Correction Factors For Other Pipe Lengths

Figure 5A.27
Pipe Flow Chart; "n" = 0.013 (USDA - NRCS)

PIPE FLOW CHART n = 0.013
FOR REINFORCED CONCRETE PIPE INLET $K_a + K_b = 1.00$ AND 70 FEET OF REINFORCED CONCRETE PIPE CONDUIT (full flow assumed)

Note correction factors for pipe lengths other than 70 feet
diameter of pipe in inches

H, in feet	13"	15"	18"	21"	24"	30"	36"	42"	48"	54"	60"	66"	72"	78"	84"	90"	96"	102"
1	3.72	5.44	8.29	11.8	15.9	26.0	38.6	53.8	71.4	91.5	114	139	167	197	229	264	302	342
2	4.55	7.69	11.7	16.7	22.5	36.8	54.6	76.0	101	129	161	197	236	278	324	374	427	483
3	5.57	9.42	14.4	20.4	27.5	45.0	66.9	93.1	124	159	198	241	289	341	397	458	523	592
4	6.43	10.9	16.6	23.5	31.8	52.0	77.3	108	143	183	228	278	334	394	459	529	604	683
5	7.19	12.2	18.5	26.3	35.5	58.1	86.4	120	160	205	255	311	373	440	513	591	675	764
6	7.88	13.3	20.3	28.8	38.9	63.7	94.6	132	175	224	280	341	409	482	562	647	739	837
7	8.51	14.4	21.9	31.1	42.0	68.8	102	142	189	242	302	368	441	521	607	699	798	904
8	9.10	15.4	23.5	33.3	44.9	73.5	109	152	202	259	323	394	472	557	648	748	854	966
9	9.65	16.3	24.9	35.3	47.7	78.0	116	161	214	275	342	418	500	590	688	793	905	1025
10	10.2	17.2	26.2	37.2	50.2	82.2	122	170	226	289	361	440	527	622	725	836	954	1080
11	10.7	18.0	27.5	39.0	52.7	86.2	128	178	237	304	379	462	553	653	761	877	1001	1133
12	11.1	18.9	28.7	40.8	55.0	90.1	134	186	247	317	395	482	578	682	794	916	1045	1184
13	11.6	19.6	29.9	42.4	57.3	93.7	139	194	257	330	411	502	601	710	827	953	1088	1232
14	12.0	20.4	31.0	44.1	59.4	97.3	145	201	267	342	427	521	624	736	858	989	1129	1278
15	12.5	21.1	32.1	45.6	61.5	101	150	208	277	354	442	539	646	762	888	1024	1169	1323
16	12.9	21.8	33.2	47.1	63.5	104	155	215	286	366	457	557	667	787	917	1057	1207	1367
17	13.3	22.4	34.2	48.5	65.5	107	159	222	294	377	471	574	688	812	946	1090	1244	1409
18	13.7	23.1	35.2	49.9	67.4	110	164	228	303	388	484	591	708	835	973	1121	1280	1450
19	14.0	23.7	36.1	51.3	69.2	113	168	234	311	399	497	607	727	858	1000	1152	1315	1489
20	14.4	24.3	37.1	52.6	71.0	116	173	240	319	409	510	623	746	880	1026	1182	1350	1528
21	14.7	24.9	38.0	53.9	72.8	119	177	246	327	419	523	638	764	902	1051	1211	1383	1566
22	15.1	25.5	38.9	55.2	74.5	122	181	252	335	429	535	653	782	923	1076	1240	1415	1603
23	15.4	26.1	39.8	56.5	76.2	125	186	258	342	439	547	668	800	944	1100	1260	1447	1639
24	15.8	26.7	40.6	57.7	77.8	127	189	263	350	448	559	682	817	964	1123	1295	1478	1674
25	16.1	27.2	41.5	58.9	79.4	130	193	269	357	458	571	696	834	984	1147	1322	1509	1708
26	16.4	27.7	42.3	60.0	81.0	133	197	274	364	467	582	710	850	1004	1169	1348	1539	1742
27	16.7	28.3	43.1	61.2	82.5	135	201	279	371	476	593	723	867	1023	1192	1373	1568	1775
28	17.0	28.8	43.9	62.3	84.1	138	204	285	378	484	604	737	883	1041	1214	1399	1597	1808
29	17.3	29.3	44.7	63.4	85.5	140	208	290	384	493	615	750	898	1060	1235	1423	1625	1840
30	17.6	29.8	45.4	64.5	87.0	142	212	294	391	501	625	763	913	1078	1256	1448	1653	1871

L, in feet	1.30	1.24	1.21	1.18	1.15	1.12	1.10	1.08	1.07	1.06	1.05	1.05	1.04	1.04	1.03	1.03	1.02	1.02	1.01
20	1.30	1.24	1.21	1.18	1.15	1.12	1.10	1.08	1.07	1.06	1.05	1.05	1.04	1.04	1.03	1.03	1.02	1.02	1.01
30	1.22	1.18	1.15	1.13	1.12	1.09	1.08	1.06	1.05	1.05	1.04	1.04	1.03	1.03	1.02	1.02	1.01	1.01	1.01
40	1.15	1.13	1.11	1.10	1.08	1.07	1.05	1.05	1.04	1.04	1.03	1.03	1.02	1.02	1.01	1.01	1.01	1.01	1.01
50	1.09	1.08	1.07	1.06	1.05	1.04	1.04	1.03	1.03	1.02	1.02	1.01	1.01	1.01	1.01	1.01	1.01	1.01	1.01
60	1.04	1.04	1.03	1.03	1.03	1.02	1.02	1.02	1.01	1.01	1.01	1.01	1.01	1.01	1.01	1.01	1.01	1.01	1.01
70	1.00	1.00	1.00	1.00	1.00	1.00	1.00	1.00	1.00	1.00	1.00	1.00	1.00	1.00	1.00	1.00	1.00	1.00	1.00
80	.96	.97	.97	.97	.98	.98	.98	.99	.99	.99	.99	.99	.99	.99	.99	.99	.99	.99	.99
90	.93	.94	.94	.94	.95	.95	.95	.96	.96	.96	.96	.96	.96	.96	.96	.96	.96	.96	.96
100	.90	.91	.92	.93	.93	.93	.93	.94	.94	.94	.94	.94	.94	.94	.94	.94	.94	.94	.94
120	.84	.86	.87	.89	.90	.91	.91	.92	.92	.92	.92	.92	.92	.92	.92	.92	.92	.92	.92
140	.80	.82	.83	.85	.86	.88	.88	.89	.89	.89	.89	.89	.89	.89	.89	.89	.89	.89	.89
160	.76	.78	.80	.82	.83	.86	.86	.88	.89	.90	.91	.92	.93	.94	.95	.96	.96	.96	.96

Correction Factors For Other Pipe Lengths

Figure 5A.28
Optional Sediment Basin Dewatering Methods

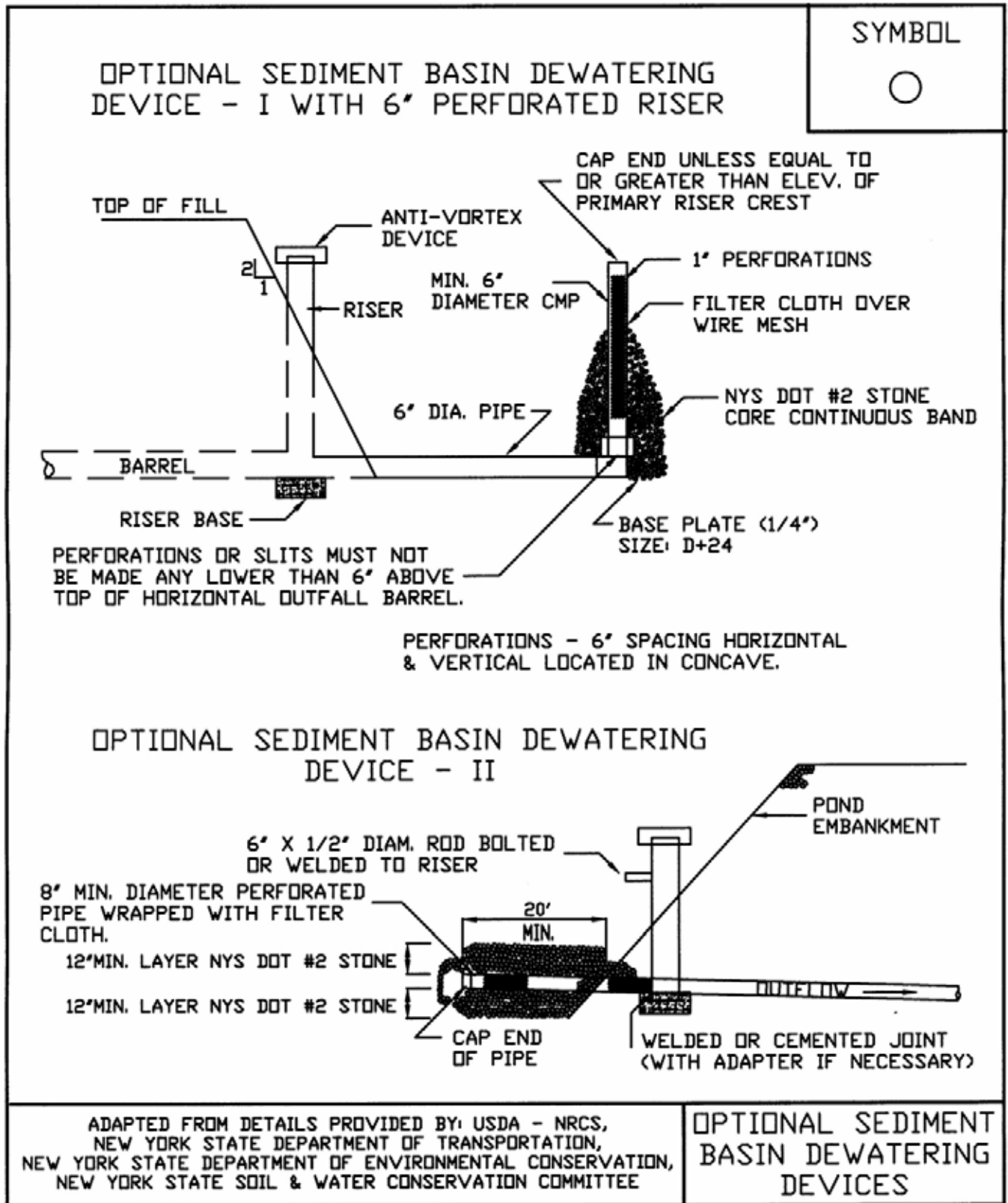
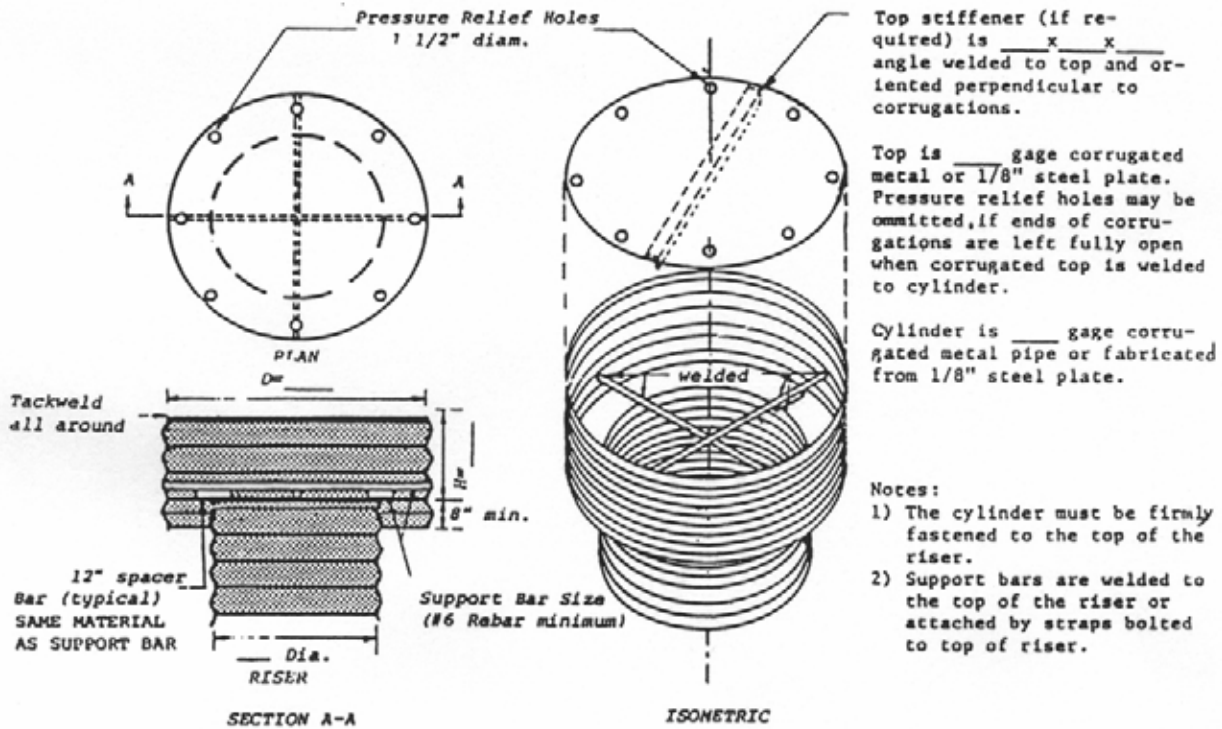

Figure 5A.29(1) Concentric Trash Rack and Anti-Vortex Device (USDA - NRCS)



CONCENTRIC TRASH RACK AND ANTI-VORTEX DEVICE
(not to scale)

Figure 5A.29(2)
Concentric Trash Rack and Anti-Vortex Device Design Table
 (USDA - NRCS)

Riser Diam.(in)	Cylinder Diam.(in.)	Thick. Gage	H.(in.)	Minimum Size Support Bar	Minimum Top	
					Thickness	Stiffener
12	18	16	6	#6 Rebar	16 ga.	—
15	21	16	7	#6 Rebar	16 ga.	—
18	27	16	8	#6 Rebar	16 ga.	—
21	30	16	11	#6 Rebar	16 ga.	—
24	36	16	13	#6 Rebar	14 ga.	—
27	42	16	15	#6 Rebar	14 ga.	—
36	54	14	17	#8 Rebar	12 ga.	—
42	60	14	19	#8 Rebar	12 ga.	—
48	72	12	21	1 1/4" pipe or 1 1/4x1 1/4x1/4 angle	10 ga.	—
54	78	12	25	See 48" Riser	10 ga.	—
60	90	12	29	1 1/2" pipe or 1 1/2x1 1/2x1/2 angle	8 ga.	—
66	96	10	33	2" pipe or 2x2x3/16 angle	8 ga. w/stiffener	2x2x1/4 angle
72	102	10	36	— See 66" Riser —		2 1/2x2 1/2x1/4 angle
78	114	10	39	2 1/2" pipe or 2x2x1/4 angle	See 72" Riser	See 72" Riser
84	120	10	42	2 1/2" pipe or 2 1/2x2 1/2x1/4 angle	See 72" Riser	2 1/2x 5/16 angle

Note: The criteria for sizing the cylinder is that the area between the inside of the cylinder and the outside of the riser is equal to or greater than the area inside the riser. Therefore, the above table is invalid for use with concrete pipe risers.

Figure 5A.30
Riser Base Details

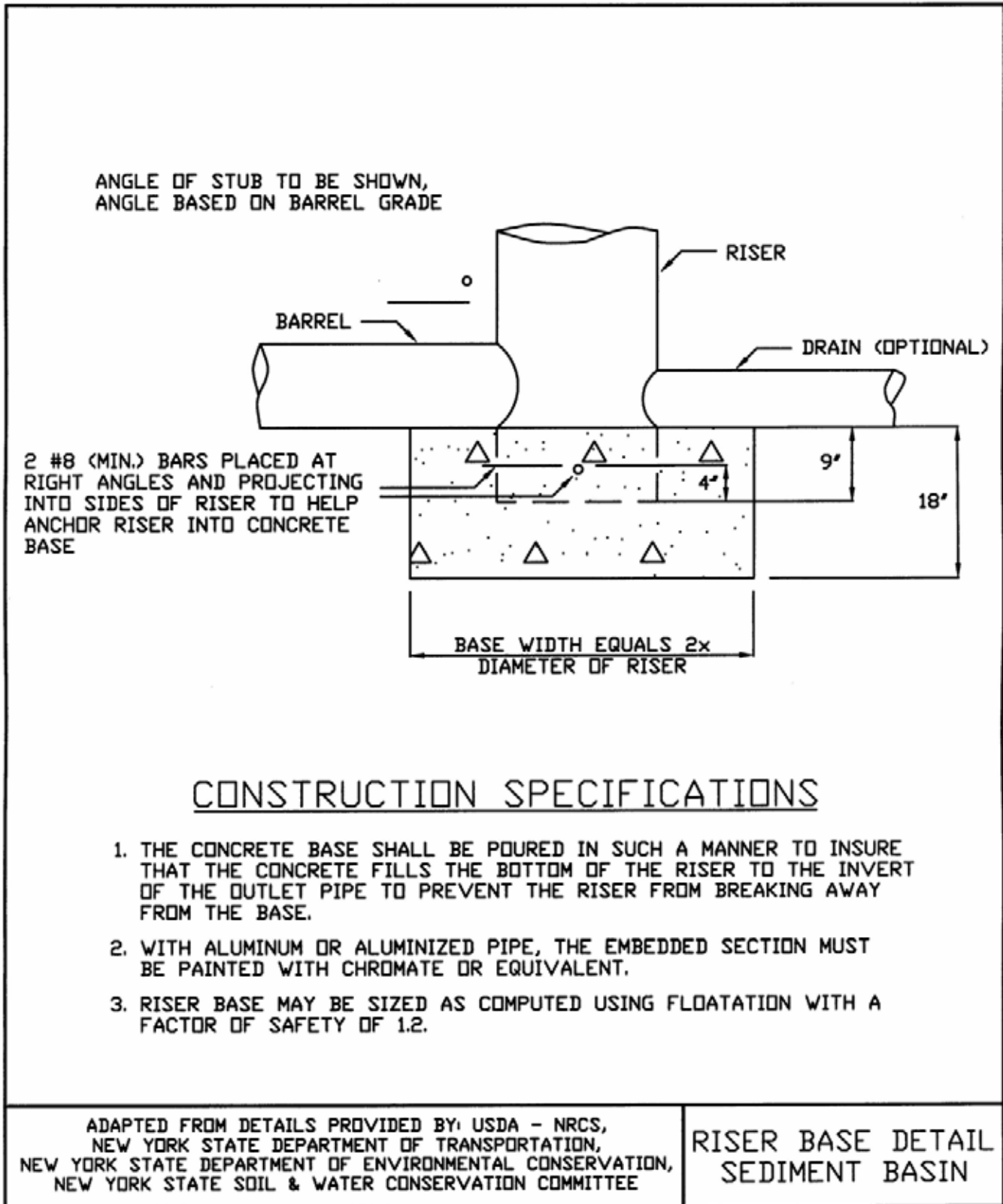

Figure 5A.31(1) Anti-Seep Collar Design

This procedure provides the anti-seep collar dimensions for only temporary sediment basins to increase the seepage length by 15% for various pipe slopes, embankment slopes and riser heights.

The first step in designing anti-seep collars is to determine the length of pipe within the saturated zone of the embankment. This can be done graphically or by the following equation, assuming that the upstream slope of the embankment intersects the invert of the pipe at its upstream end. (See embankment-invert intersection on the drawing below:

$$L_s = y (z + 4) \left[1 + \frac{\text{pipe slope}}{0.25 - \text{pipe slope}} \right]$$

Where: L_s = length of pipe in the saturated zone (ft.)

y = distance in feet from upstream invert of pipe to highest normal water level expected to occur during the life of the structure, usually the top of the riser.

z = slope of upstream embankment as a ratio of z ft. horizontal to one ft. vertical.

pipe slope = slope of pipe in feet per foot.

This procedure is based on the approximation of the phreatic line as shown in the drawing below:

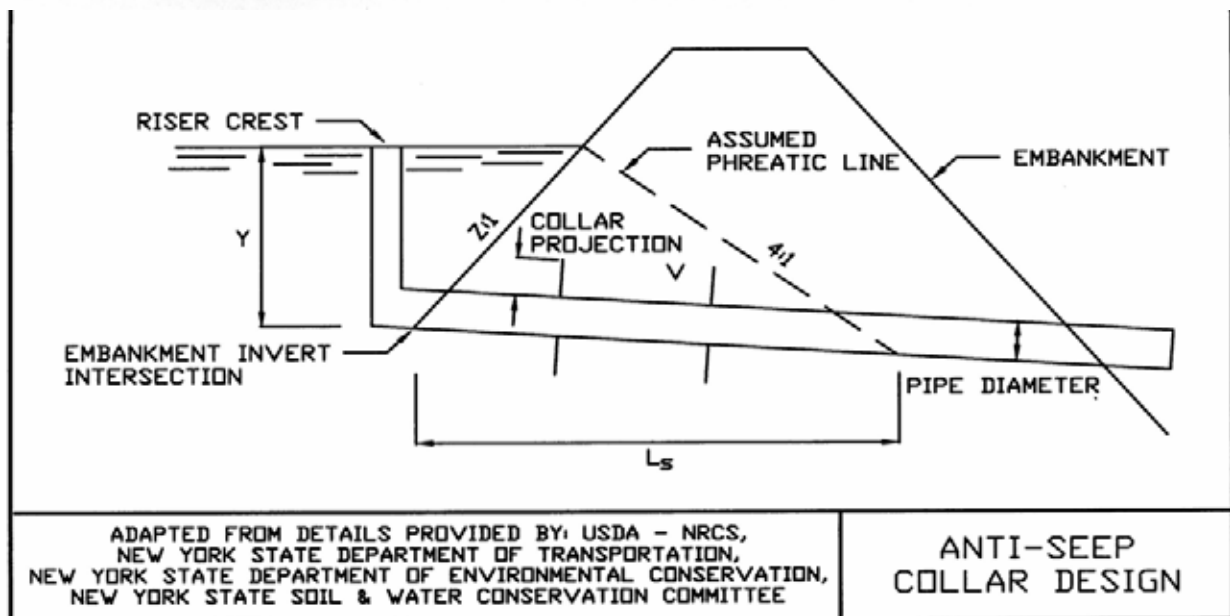
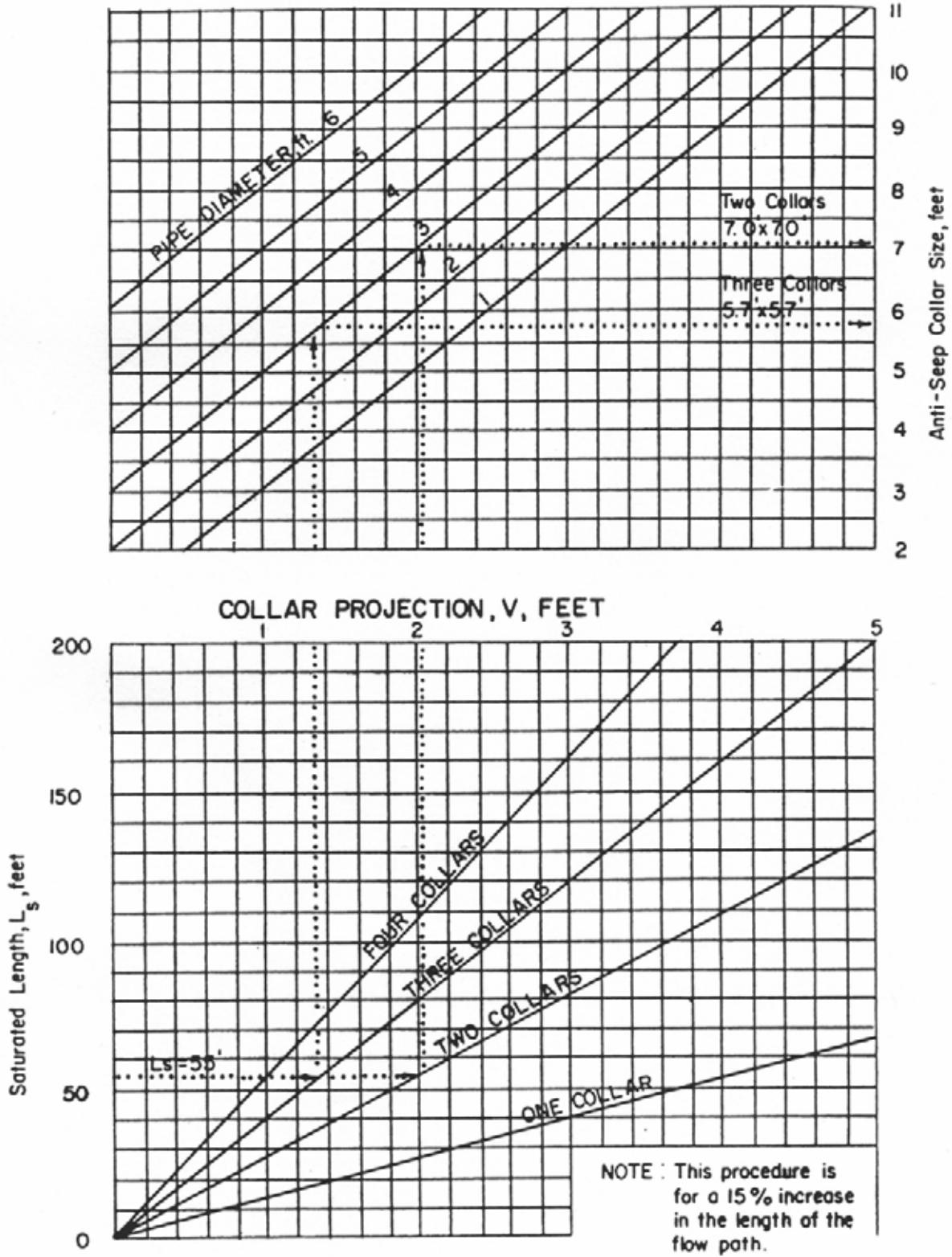

Figure 5A.31(2)
Anti-Seep Collar Design Charts (USDA - NRCS)



**Figure 5A.32
Anti-Seep Collar Design**

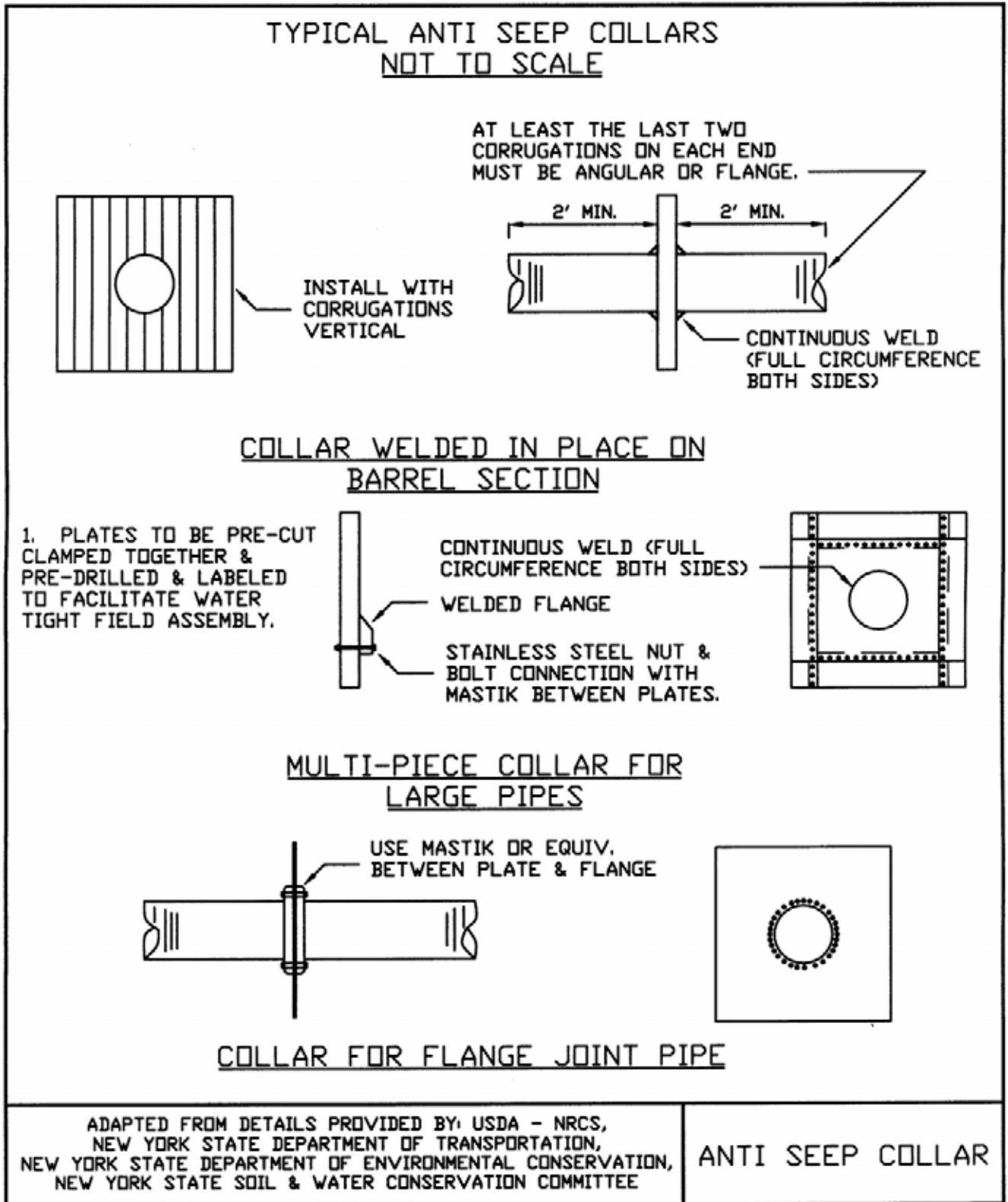

Figure 5A.33(1)
Design Data for Earth Spillways

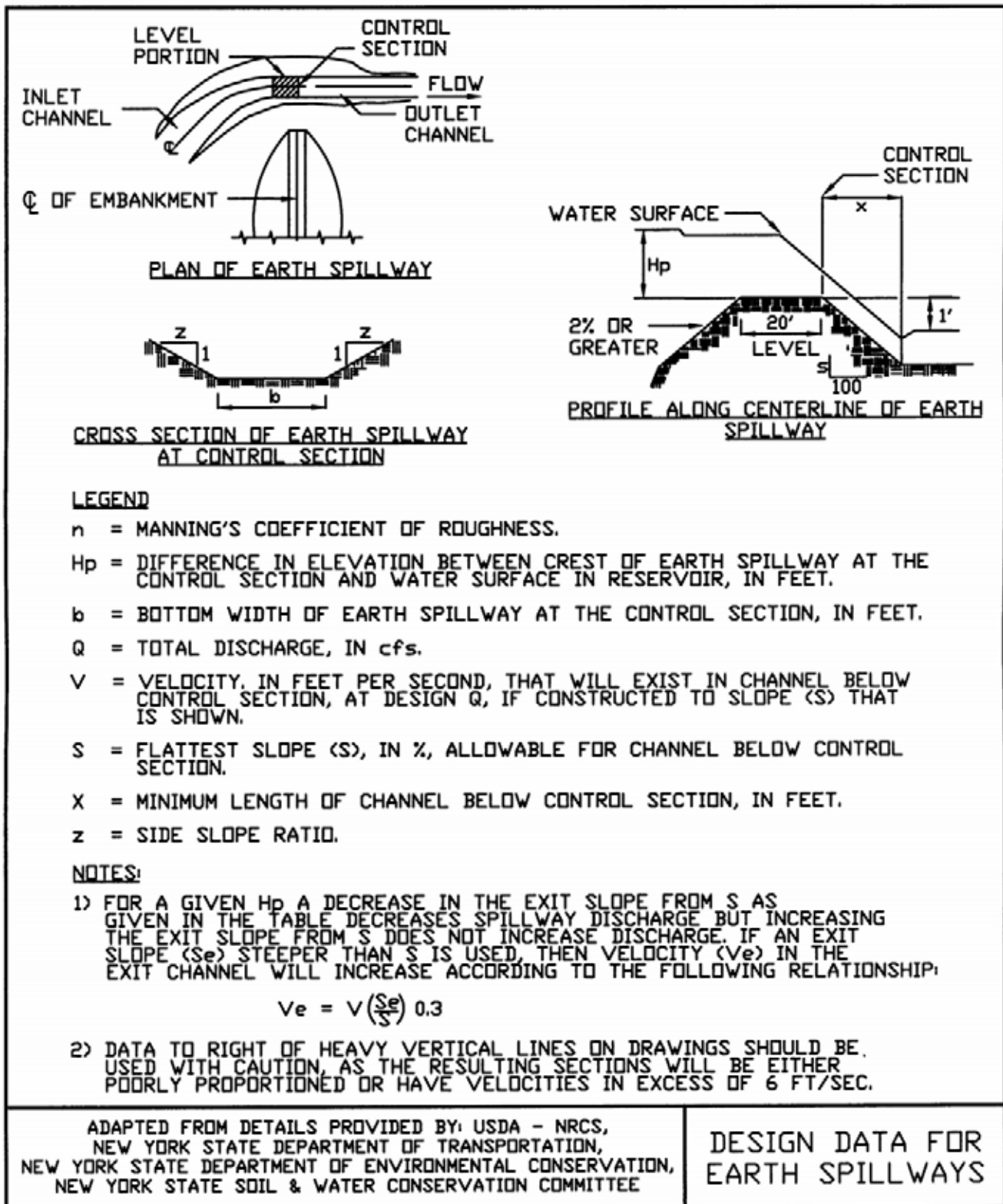

Figure 5A.33(2)
Design Table for Vegetated Spillways Excavated in
Erosion Resistant Soils (side slopes—3 horizontal : 1 vertical)
 (USDA - NRCS)

Discharge Q CFS	Slope Range		Bottom Width Feet	Stage Feet	Discharge Q CFS	Slope Range		Bottom Width Feet	Stage Feet
	Minimum Percent	Maximum Percent				Minimum Percent	Maximum Percent		
15	3.3	12.2	8	.83	80	2.8	5.2	24	1.24
	3.5	18.2	12	.89		2.8	5.9	28	1.14
20	3.1	8.9	8	.97	90	2.9	7.0	32	1.08
	3.2	13.0	12	.81		2.5	2.6	12	1.84
25	3.3	17.3	16	.70	2.5	3.1	16	1.61	
	2.9	7.1	8	1.09	2.6	3.8	20	1.45	
	3.2	9.9	12	.91	2.7	4.5	24	1.32	
30	3.3	13.2	16	.79	2.8	5.3	28	1.22	
	3.3	17.2	20	.70	2.8	6.1	32	1.14	
	2.9	6.0	8	1.20	2.5	2.8	16	1.71	
35	3.0	8.2	12	1.01	2.6	3.3	20	1.54	
	3.0	10.7	16	.88	2.6	4.0	24	1.41	
	3.3	13.8	20	.78	2.7	4.8	28	1.30	
40	2.8	5.1	8	1.30	2.7	5.3	32	1.21	
	2.9	6.9	12	1.10	2.8	6.1	36	1.13	
	3.1	9.0	16	.94	2.5	2.8	20	1.71	
	3.1	11.3	20	.85	2.6	3.2	24	1.56	
45	3.2	14.1	24	.77	2.7	3.8	28	1.44	
	2.7	4.5	8	1.40	2.7	4.2	32	1.34	
	2.9	6.0	12	1.18	2.7	4.8	36	1.26	
	2.9	7.6	16	1.03	2.5	2.7	24	1.71	
50	3.1	9.7	20	.91	2.5	3.2	28	1.58	
	3.1	11.9	24	.83	2.6	3.6	32	1.47	
	2.6	4.1	8	1.49	2.6	4.0	36	1.38	
	2.8	5.3	12	1.25	2.7	4.5	40	1.30	
55	2.9	6.7	16	1.09	2.5	2.7	28	1.70	
	3.0	8.4	20	.98	2.5	3.1	32	1.58	
	3.0	10.4	24	.89	2.6	3.4	36	1.49	
	2.7	3.7	8	1.57	2.6	3.8	40	1.40	
60	2.8	4.7	12	1.33	2.7	4.3	44	1.33	
	2.8	6.0	16	1.16	2.4	2.7	32	1.72	
	2.9	7.3	20	1.03	2.4	3.0	36	1.60	
	3.1	9.0	24	.94	2.5	3.4	40	1.51	
65	2.6	3.1	8	1.73	2.6	3.7	44	1.43	
	2.7	3.9	12	1.47	2.5	2.7	36	1.70	
	2.7	4.8	16	1.28	2.5	2.9	40	1.60	
	2.9	5.9	20	1.15	2.5	3.3	44	1.52	
	2.9	7.3	24	1.05	2.6	3.6	48	1.45	
70	3.0	8.6	28	.97	2.4	2.6	40	1.70	
	2.5	2.8	8	1.88	2.5	2.9	44	1.61	
	2.6	3.3	12	1.60	2.5	3.2	48	1.53	
	2.6	4.1	16	1.40	2.5	2.6	44	1.70	
	2.7	5.0	20	1.26	2.5	2.9	48	1.62	
75	2.8	6.1	24	1.15	2.6	3.2	52	1.54	
	2.9	7.0	28	1.05	2.4	2.6	48	1.70	
	2.5	2.9	12	1.72	2.5	2.9	52	1.62	
	2.6	3.6	16	1.51	2.4	2.6	52	1.70	
	2.7	4.3	20	1.35	2.5	2.6	56	1.69	

Figure 5A.33(3)
Design Table for Vegetated Spillways Excavated in
Very Erodible Soils (side slopes—3 horizontal : 1 vertical)
 (USDA - NRCS)

Discharge Q CFS	Slope Range		Bottom Width Feet	Stage Feet
	Minimum Percent	Maximum Percent		
10	3.5	4.7	8	.68
15	3.4	4.4	12	.69
	3.4	5.9	16	.60
20	3.3	3.3	12	.80
	3.3	4.1	16	.70
	3.5	5.3	20	.62
25	3.3	3.3	16	.79
	3.3	4.0	20	.70
	3.5	4.9	24	.64
30	3.3	3.3	20	.78
	3.3	4.0	24	.71
	3.4	4.7	28	.65
	3.4	5.5	32	.61
35	3.2	3.2	24	.77
	3.3	3.9	28	.71
	3.5	4.6	32	.66
	3.5	5.2	36	.62
40	3.3	3.3	28	.76
	3.4	3.8	32	.71
	3.4	4.4	36	.67
	3.4	5.0	40	.64
45	3.3	3.3	32	.76
	3.4	3.8	36	.71
	3.4	4.3	40	.67
	3.4	4.8	44	.64
50	3.3	3.3	36	.75
	3.3	3.8	40	.71
	3.3	4.3	44	.68
60	3.2	3.2	44	.75
	3.2	3.7	48	.72
70	3.3	3.3	52	.75
80	3.1	3.1	56	.78

Procedure for Determining or Altering Sediment Basin Shape

As specified in the Standard and Specification, the pool area at the elevation of the crest of the principal spillway shall have a length to width ratio of at least 2.0 to 1. The purpose of this requirement is to minimize the “short circuiting” effect of the sediment laden inflow to the riser and thereby increase the effectiveness of the sediment basin. The purpose of this procedure is to prescribe the parameters, procedures, and methods of determining and modifying the shape of the basin.

The length of the flow path (L) is the distance from the point of inflow to the riser (outflow point). The point of inflow is the point that the stream enters the normal pool (pool level at the riser crest elevation). The pool area (A) is the area of the normal pool. The effective width (W_e) is found by the equation:

$$W_e = A/L \text{ and } L:W \text{ ratio} = L/W_e$$

In the event there is more than one inflow point, any inflow point that conveys more than 30 percent of the total peak inflow rate shall meet the length to width ratio criteria.

The required basin shape may be obtained by proper site selection by excavation or by constructing a baffle in the basin. The purpose of the baffle is to increase the effective flow length from the inflow point to the riser. Baffles (see Figure 5A.34 on following page) shall be placed midway between the inflow point around the end of the baffle to the outflow point. Then:

$$W_e = A/L_e \text{ and } L:W \text{ ratio} = L_e/W_e$$

Three examples are shown on the following page. Note that for the special case in example C the water is allowed to go around both ends of the baffle and the effective length, $L_e = L_1 + L_2$. Otherwise, the length to width ratio computations are the same as shown above. This special case procedure for computing L_e is allowable only when the two flow paths are equal, i.e., when $L_1 = L_2$. A baffle detail is also shown in Figure 5A.37 on page 5A.72.

Figure 5A.34 Sediment Basin Baffle Details (USDA - NRCS)

Examples: Plan Views - not to scale

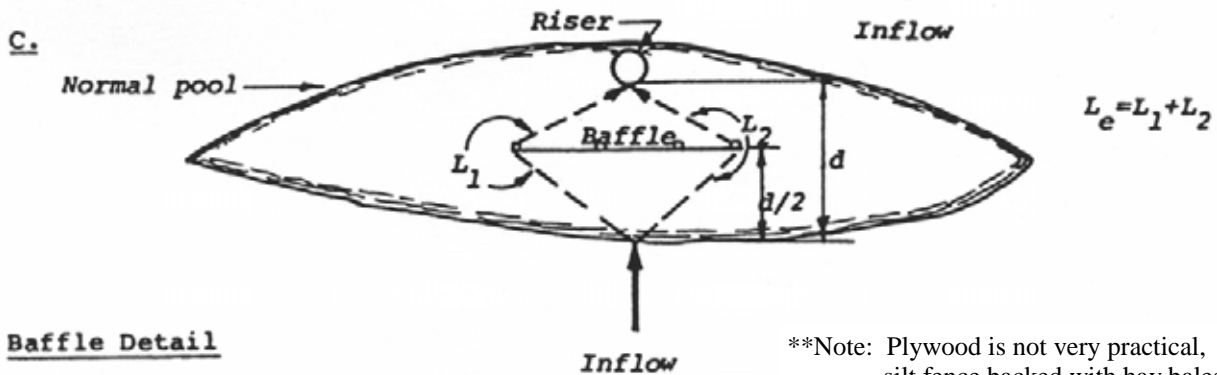
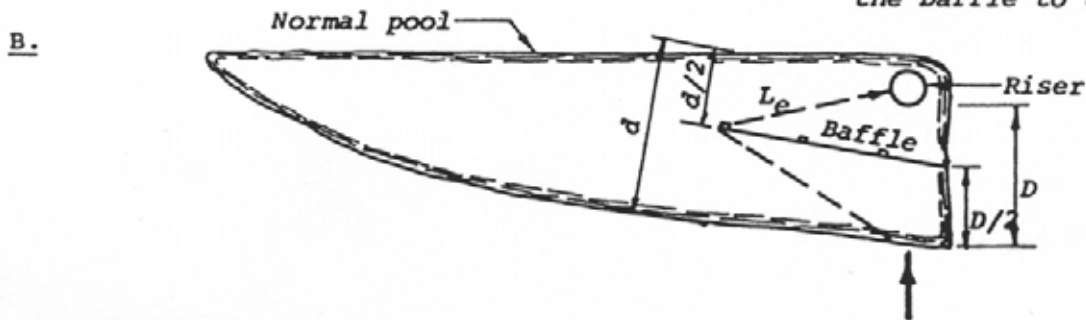
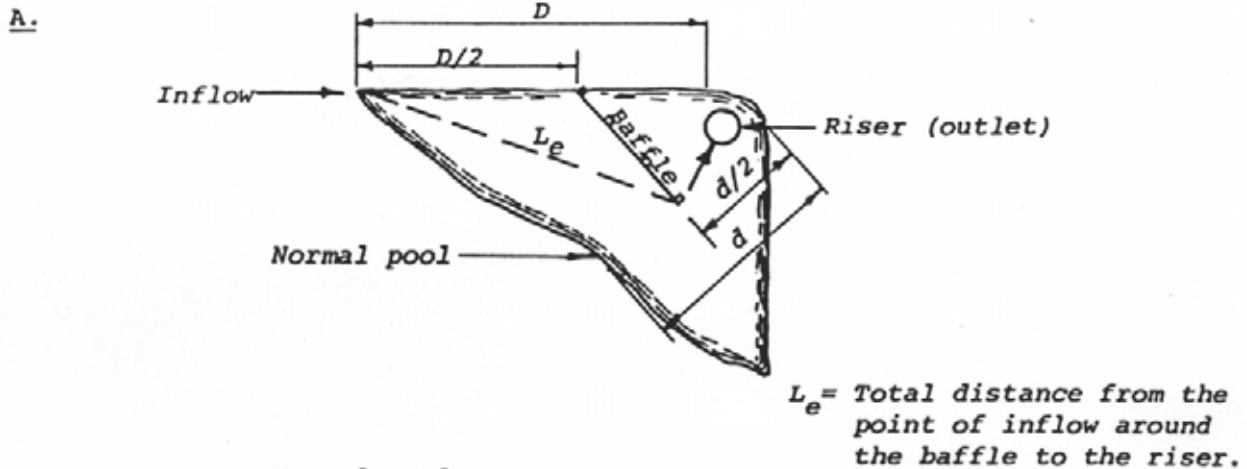

Baffle Detail

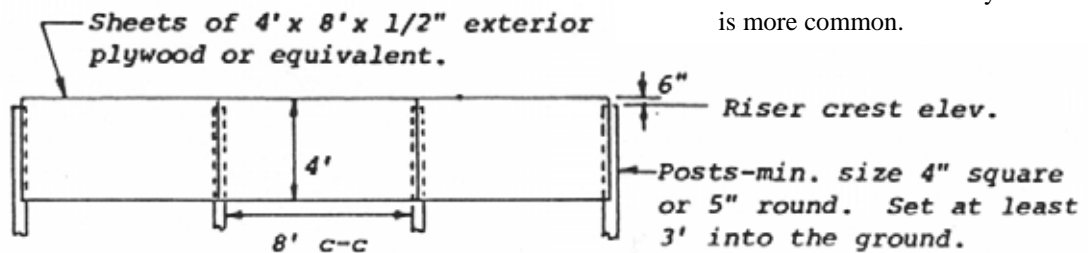

**Note: Plywood is not very practical, silt fence backed with hay bales is more common.

STANDARD AND SPECIFICATIONS FOR STABILIZED CONSTRUCTION ENTRANCE



Definition

A stabilized pad of aggregate underlain with geotextile located at any point where traffic will be entering or leaving a construction site to or from a public right-of-way, street, alley, sidewalk, or parking area.

Purpose

The purpose of stabilized construction entrance is to reduce or eliminate the tracking of sediment onto public rights-of-way or streets.

Conditions Where Practice Applies

A stabilized construction entrance shall be used at all points of construction ingress and egress.

Design Criteria

See Figure 5A.35 on page 5A.76 for details.

Aggregate Size: Use a matrix of 1-4 inch stone, or reclaimed or recycled concrete equivalent.

Thickness: Not less than six (6) inches.

Width: 12-foot minimum but not less than the full width of points where ingress or egress occurs. 24-foot minimum if there is only one access to the site.

Length: As required, but not less than 50 feet (except on a single residence lot where a 30 foot minimum would apply).

Geotextile: To be placed over the entire area to be covered with aggregate. Filter cloth will not be required on a single-family residence lot. Piping of surface water under entrance shall be provided as required. If piping is impossible, a mountable berm with 5:1 slopes will be permitted.

Criteria for Geotextile

The geotextile shall be woven or nonwoven fabric consisting only of continuous chain polymeric filaments or yarns of polyester. The fabric shall be inert to commonly encountered chemicals, hydro-carbons, mildew, rot resistant, and conform to the fabric properties as shown:

Fabric Properties ³	Light Duty ¹	Heavy Duty ²	Test Method
	Roads Grade Subgrade	Haul Roads Rough Graded	
Grab Tensile Strength (lbs)	200	220	ASTM D1682
Elongation at Failure (%)	50	60	ASTM D1682
Mullen Brust Strength (lbs)	190	430	ASTM D3786
Puncture Strength (lbs)	40	125	ASTM D751 modified
Equivalent Opening Size	40-80	40-80	US Std Sieve CW-02215
Aggregate Depth	6	10	--

¹Light Duty Road: Area sites that have been graded to subgrade and where most travel would be single axle vehicles and an occasional multi-axle truck. Acceptable materials are Trevira Spunbond 1115, Mirafi 100X, Tynpar 3401, or equivalent.

²Heavy Duty Road: Area sites with only rough grading, and where most travel would be multi-axle vehicles. Acceptable materials are Trevira Spunbond 1135, Mirafi 600X, or equivalent.

³Fabrics not meeting these specifications may be used only when design procedure and supporting documentation are supplied to determine aggregate depth and fabric strength.

Maintenance

The entrance shall be maintained in a condition which will prevent tracking of sediment onto public rights-of-way or streets. This may require periodic top dressing with additional aggregate. All sediment spilled, dropped, or washed onto public rights-of-way must be removed immediately.

When necessary, wheels must be cleaned to remove sediment prior to entrance onto public rights-of-way. When washing is required, it shall be done on an area stabilized with aggregate, which drains into an approved sediment-trapping device. All sediment shall be prevented from entering storm drains, ditches, or watercourses.

**Figure 5A.35
Stabilized Construction Entrance**

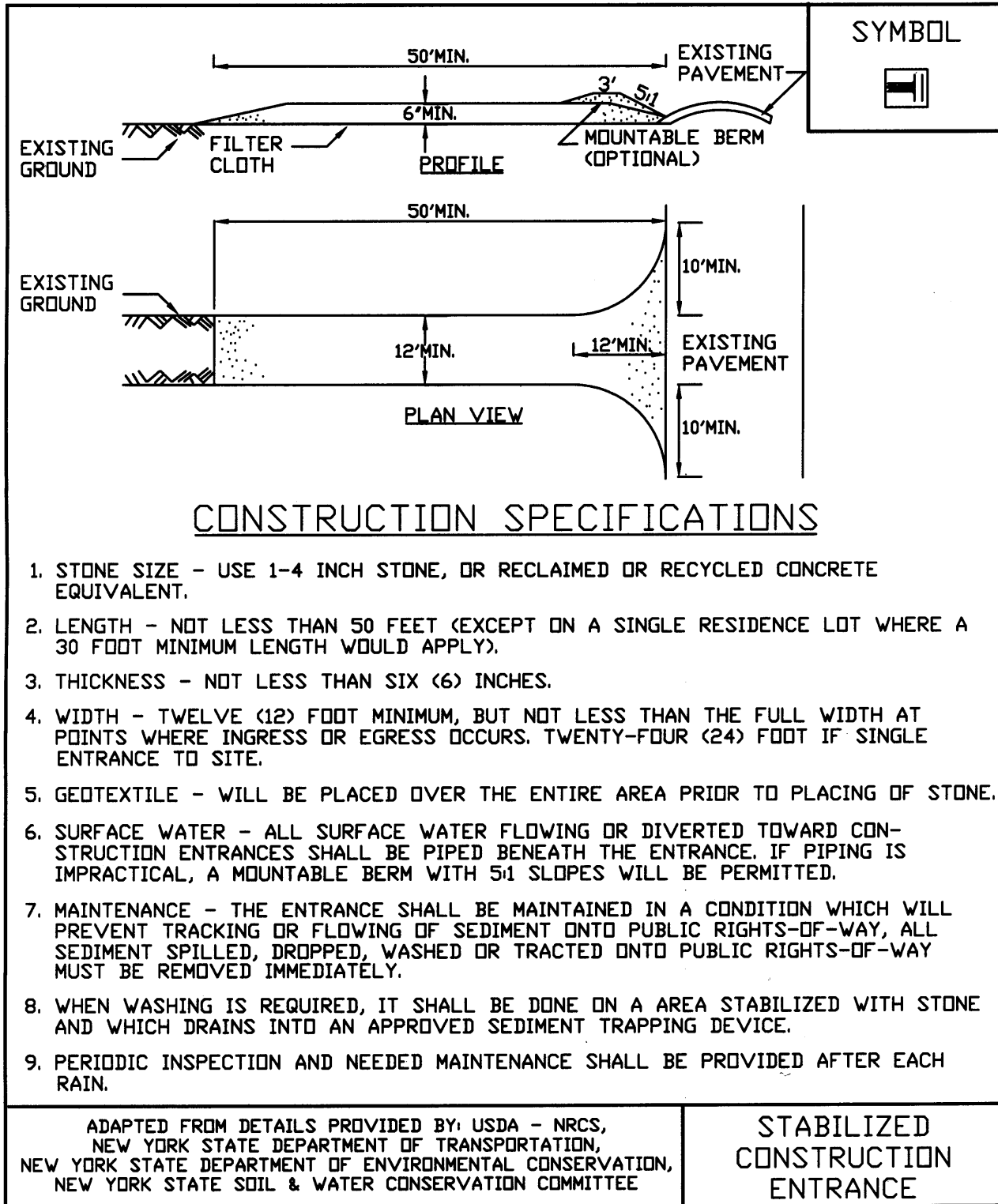

STANDARD AND SPECIFICATIONS FOR CONSTRUCTION ROAD STABILIZATION



Definition

The stabilization of temporary construction access routes, on-site vehicle transportation routes, and construction parking areas.

Purpose

To control erosion on temporary construction routes and parking areas.

Condition Where Practice Applies

All traffic routes and parking areas for temporary use by construction traffic.

Design Criteria

Construction roads should be located to reduce erosion potential, minimize impact on existing site resources, and maintain operations in a safe manner. Highly erosive soils, wet or rocky areas, and steep slopes should be avoided. Roads should be routed where seasonal water tables are deeper than 18 inches. Surface runoff and control should be in accordance with other standards.

Road Grade – A maximum grade of 12% is recommended, although grades up to 15% are possible for short distances.

Road Width – 14 foot minimum for one-way traffic or 24 foot minimum for two-way traffic.

Side Slope of Road Embankment – 2:1 or flatter.

Ditch Capacity – On-site roadside ditch and culvert capacities shall be the 10 yr. peak runoff.

Composition – Use a 6-inch layer of NYS DOT sub-base Types 1,2,3, 4 or equivalent as specified in NYS – Standards and Specifications for Highways.

Construction Specifications

1. Clear and strip roadbed and parking areas of all vegetation, roots, and other objectionable material.
2. Locate parking areas on naturally flat areas as available. Keep grades sufficient for drainage, but not more than 2 to 3 percent.
3. Provide surface drainage and divert excess runoff to stabilized areas.
4. Maintain cut and fill slopes to 2:1 or flatter and stabilized with vegetation as soon as grading is accomplished.
5. Spread 6-inch layer of sub-base material evenly over the full width of the road and smooth to avoid depressions.
6. Provide appropriate sediment control measures to prevent offsite sedimentation.

Maintenance

Inspect construction roads and parking areas periodically for condition of surface. Topdress with new gravel as needed. Check ditches for erosion and sedimentation after rainfall events. Maintain vegetation in a health, vigorous condition. Areas producing sediment should be treated immediately.

STANDARD AND SPECIFICATIONS FOR TEMPORARY ACCESS WATERWAY CROSSING



Definition

A temporary access waterway crossing is a structure placed across a waterway to provide access for construction purposes for a period of less than one year. Temporary access crossings shall not be utilized to maintain traffic for the general public.

Purpose

The purpose of the temporary access waterway crossing is to provide safe, environmentally sound access across a waterway for construction equipment by establishing minimum standards and specifications for the design, construction, maintenance, and removal of the structure. Temporary access waterway crossings are necessary to prevent construction equipment from damaging the waterway, blocking fish migration, and tracking sediment and other pollutants into the waterway. This standard and specification may represent a channel constriction, thus, the temporary nature of waterway access crossing must be stressed. They should be planned to be in service for the shortest practical period of time and removed as soon as their function is completed.

Conditions Where Practice Applies

The following standard and specification for temporary access waterway crossings are applicable in non-tidal waterways. These standard and specifications provide designs based on waterway geometry rather than the drainage area contributing to the point of crossing.

The principal consideration for development of the standard and specifications is concern for erosion and sediment

control. Structural utility and safety must also be considered when designing temporary access waterway crossings to withstand expected loads.

The three types of standard temporary access waterway crossings are bridges, culverts, and fords.

General Requirements

1. **In-Stream Excavation:** In-Stream excavation shall be limited to only that necessary to allow installation of the standard methods as presented in Subsection "Temporary Access Waterway Crossing Methods."

2. **Elimination of Fish Migration Barriers:** Of the three basic methods presented in Subsection "Temporary Access Waterway Crossing Methods," bridges pose the least potential for creating barriers to aquatic migration. The construction of any specific crossing method as presented in Subsection "Temporary Access Waterway Crossing Methods," shall not cause a significant water level difference between the upstream and downstream water surface elevations. Fish spawning or migration within waterways is from October 1 to April 30 for water classified for trout and from March 15 to June 15 for other streams. Restrictions imposed by the NYS Department of Environmental Conservation during these time periods may apply and must be checked.

3. **Crossing Alignment:** The temporary waterway crossing shall be at right angles to the stream. Where approach conditions dictate, the crossing may vary 15 degrees from a line drawn perpendicular to the centerline of the stream at the intended crossing location.

4. **Road Approaches:** The centerline of both roadway approaches shall coincide with the crossing alignment centerline for a minimum distance of 50 feet from each bank of the waterway being crossed. If physical or right-of-way restraints preclude the 50 feet minimum, a shorter distance may be provided. All fill materials associated with the roadway approach shall be limited to a maximum height of 2 feet above the existing flood plain elevation.

5. **Surface Water Diverting Structure:** A water diverting structure such as a swale shall be constructed (across the roadway on both roadway approaches) 50 feet (maximum) on either side of the waterway

crossing. This will prevent roadway surface runoff from directly entering the waterway. The 50 feet is measured from the top of the waterway bank. Design criteria for this diverting structure shall be in accordance with the “Standard and Specification” for the individual design standard of choice. If the roadway approach is constructed with a reverse grade away from the waterway, a separate diverting structure is not required.

6. **Road Width:** All crossings shall have one traffic lane. The minimum width shall be 12 feet with a maximum width of 20 feet.

7. **Time of Operation:** All temporary crossing shall be removed within 14 calendar days after the structure is no longer needed. Unless prior written approval is obtained, all structures shall be removed within one year from the date of the installation.

8. **Materials**

A. **Aggregate:** There shall be no earth or soil materials used for construction within the waterway channel. NYS DOT specifications for coarse aggregate designation No. 4 (3/4” to 4”), also referenced as AASHTO designation No. 1, shall be the minimum acceptable aggregate size for temporary crossings. Larger aggregates will be allowed.

B. **Filter Cloth:** Filter cloth is a fabric consisting of either woven or nonwoven plastic, polypropylene, or nylon used to distribute the load, retain fines, allow increased drainage of the aggregate and reduce mixing of the aggregate with the subgrade soil. Filter cloths such as Mirafi, Typar, Adva Filter, Polyfilter X, or approved equivalent shall be used, as required by the specific method.

Temporary Access Waterway Crossing Methods

The following criteria for erosion and sediment control shall be considered when selecting a specific temporary access waterway crossing standard method:

1. **Site aesthetics:** Select a standard design method that will least disrupt the existing terrain of the stream reach. Consider the effort that will be required to restore the area after the temporary crossing is removed.
2. **Site location:** Locate the temporary crossing where there will be the least disturbance to the soils of the

existing waterway banks. When possible, locate the crossing at a point receiving minimal surface runoff.

3. **Physical site constraints:** The physical constraints of a site may preclude the selection of one or more of the standard methods.

4. **Time of year:** The time of year may preclude the selection of one or more of the standard methods due to fish spawning or migration restrictions.

5. **Vehicular loads and traffic patterns:** Vehicular loads, traffic patterns, and frequency of crossing should be considered in choosing a specific method.

6. **Maintenance of crossing:** The standard methods will require various amounts of maintenance. The bridge method should require the least maintenance, whereas the ford method will probably require more intensive maintenance.

7. **Removal of the Structure:** Ease of removal and subsequent damage to the waterway should be primary factors in considering the choice of a standard method.

Temporary Access Bridge (Figure 5A.36 on page 5A.84)

A temporary access bridge is a structure made of wood, metal, or other materials, which provides access across a stream or waterway.

Considerations

1. This is the preferred method for temporary access waterway crossings. Normally, bridge construction causes the least disturbance to the waterway bed and banks when compared to the other access waterway crossings.
2. Most bridges can be quickly removed and reused.
3. Temporary access bridges pose the least chance for interference with fish migration when compared to the other temporary access waterway crossings.
4. **Restrictions and Permits:** A permit from the New York State Department of Environmental Conservation, Division of Regulatory Affairs, Regional Permit Administrator, will be needed to install and remove temporary access culverts in streams with a classification of C(T) and higher. Installation and removal may not be permitted during the period of time from the start of trout spawning until the eggs have hatched. In some instances, restrictions may also be applied to bass spawning waters.

Construction Specifications

1. **Restriction:** Construction, use, or removal of a temporary access bridge will not normally have any time of year restrictions if construction, use, or removal does not disturb the stream or its banks.
2. **Bridge Placement:** A temporary bridge structure shall be constructed at or above bank elevation to prevent the entrapment of floating materials and debris.
3. **Abutments:** Abutments shall be placed parallel to and on stable banks.
4. **Bridge Span:** Bridges shall be constructed to span the entire channel. If a footing, pier, or bridge support is constructed within the waterway, a stream-disturbance permit may be required.
5. **Stringers:** Stringers shall either be logs, saw timber, pre-stressed concrete beams, metal beams, or other approved materials.
6. **Deck Material:** Decking shall be of sufficient strength to support the anticipated load. All decking members shall be placed perpendicular to the stringers, butted tightly, and securely fastened to the stringers. Decking materials must be butted tightly to prevent any soil material tracked onto the bridge from falling into the waterway below.
7. **Run Planks (optional):** Run planking shall be securely fastened to the length of the span. One run plank shall be provided for each track of the equipment wheels. Although run planks are optional, they may be necessary to properly distribute loads.
8. **Curbs or Fenders:** Curbs or fenders may be installed along the outer sides of the deck. Curbs or fenders are an option, which will provide additional safety.
9. **Bridge Anchors:** Bridges shall be securely anchored at only one end using steel cable or chain. Anchoring at only one end will prevent channel obstruction in the event that floodwaters float the bridge. Acceptable anchors are large trees, large boulders, or driven steel anchors. Anchoring shall be sufficient to prevent the bridge from floating downstream and possibly causing an obstruction to the flow.
10. **Stabilization:** All areas disturbed during installation shall be stabilized within 14 calendar days of that disturbance in accordance with the Standard and Specification for Temporary Critical Area Plantings on page 3.3.

Bridge Maintenance Requirements

1. **Inspection:** Periodic inspection shall be performed by the user to ensure that the bridge, streambed, and streambanks are maintained and not damaged.
2. **Maintenance:** Maintenance shall be performed, as needed to ensure that the structure complies with the standard and specifications. This shall include removal and disposal of any trapped sediment or debris. Sediment shall be disposed of outside of the floodplain and stabilized.

Bridge Removal and Clean-Up Requirements

1. **Removal:** When the temporary bridge is no longer needed, all structures including abutments and other bridging materials shall be removed within 14 calendar days. In all cases, the bridge materials shall be removed within one year of installation.
2. **Final Clean-Up:** Final clean-up shall consist of removal of the temporary bridge from the waterway, protection of banks from erosion, and removal of all construction materials. All removed materials shall be stored outside the waterway floodplain.
3. **Method:** Removal of the bridge and clean-up of the area shall be accomplished without construction equipment working in the waterway channel.
4. **Final Stabilization:** All areas disturbed during removal shall be stabilized within 14 calendar days of that disturbance in accordance with the Standard and Specifications for Permanent Critical Area Plantings on page 5.5.

Temporary Access Culvert (Figure 5A.37 on page 5A.85)

A temporary access culvert is a structure consisting of a section(s) of circular pipe, pipe arches, or oval pipes of reinforcing concrete, corrugated metal, or structural plate, which is used to convey flowing water through the crossing.

Considerations

1. Temporary culverts are used where a) the channel is too wide for normal bridge construction, b) anticipated loading may prove unsafe for single span bridges, or c) access is not needed from bank to bank.
2. This temporary waterway crossing method is normally preferred over a ford type of crossing, since disturbance to the waterway is only during construction and removal of the culvert.
3. Temporary culverts can be salvaged and reused.

Construction Specifications

1. **Restrictions and Permits:** A permit from the New York State Department of Environmental Conservation, Division of Regulatory Affairs, Regional Permit Administrator, will be needed to install and remove temporary access culverts in streams with a classification of C(T) and higher. Installation and removal may not be permitted during the period of time from the start of trout spawning until the eggs have hatched. In some instances, restrictions may also be applied to bass spawning waters.
2. **Culvert Strength:** All culverts shall be strong enough to support their cross sectional area under maximum expected loads.
3. **Culvert Size:** The size of the culvert pipe shall be the largest pipe diameter that will fit into the existing channel without major excavation of the waterway channel or without major approach fills. If a channel width exceeds 3 feet, additional pipes may be used until the cross sectional area of the pipes is greater than 60 percent of the cross sectional area of the existing channel. The minimum size culvert that may be used is 12-inch diameter pipe.
4. **Culvert Length:** The culvert(s) shall extend a minimum of one foot beyond the upstream and downstream toe of the aggregate placed around the culvert. In no case shall the culvert exceed 40 feet in length.
5. **Filter Cloth:** Filter cloth shall be placed on the streambed and streambanks prior to placement of the pipe culvert(s) and aggregate. The filter cloth shall cover the streambed and extend a minimum six inches and a maximum one foot beyond the end of the culvert and bedding material. Filter cloth reduces settlement and improves crossing stability.
6. **Culvert Placement:** The invert elevation of the culvert shall be installed on the natural streambed grade to minimize interference with fish migration (free passage of fish).
7. **Culvert Protection:** The culvert(s) shall be covered with a minimum of one foot of aggregate. If multiple culverts are used, they shall be separated by at least 12 in. of compacted aggregate fill. At the minimum, the bedding and fill material used in the construction of them temporary access culvert crossings shall conform with the aggregate requirements cited in the General Requirements subsection.
8. **Stabilization:** All areas disturbed during culvert installation shall be stabilized within 14 calendar days of the disturbance in accordance with the Standard for

Permanent Critical Area Plantings.

Culvert Maintenance Requirements

1. **Inspection:** Periodic inspection shall be performed to ensure that the culverts, streambed, and streambanks are not damaged, and that sediment is not entering the stream or blocking fish passage or migration.
2. **Maintenance:** Maintenance shall be performed, as needed in a timely manner to ensure that structures are in compliance with this standard and specification. This shall include removal and disposal of any trapped sediment or debris. Sediment shall be disposed of and stabilized outside the waterway flood plain.

Culvert Removal and Clean-Up Requirements

1. **Removal:** When the crossing has served its purpose, all structures, including culverts, bedding, and filter cloth materials shall be removed within 14 calendar days. In all cases, the culvert materials shall be removed within one year of installation. No structure shall be removed during the spawning season (March 15 through June 15).
2. **Final Clean-Up:** Final clean-up shall consist of removal of the temporary structure from the waterway, removal of all construction materials, restoration of original stream channel cross section, and protection of the streambanks from erosion. Removed material shall be stored outside of the waterway floodplain.
3. **Method:** Removal of the structure and clean-up of the area shall be accomplished without construction equipment working in the waterway channel.
4. **Final Stabilization:** All areas disturbed during culvert removal shall be stabilized within 14 calendar days of the disturbance in accordance with the Standard for Permanent Critical Area Plantings.

Temporary Access Ford (Figure 5A.38 on page 5A.86)

A temporary access ford is a shallow structure placed in the bottom of a waterway over which the water flows while still allowing traffic to cross the waterway.

Considerations

Temporary fords may be used when the streambanks are less than four (4) feet above the invert of the stream, and the streambed is armored with naturally occurring bedrock, or can be protected with an aggregate layer in conformance with these specifications.

Construction Specifications

1. Restrictions and Permits: A permit from New York State Department of Environmental Conservation, Division of Regulatory Affairs, Regional Permit Administrator, will be needed to install, use, and remove temporary fords in streams with a classification of C(T) or higher. Installation and removal may not be permitted during the period of time from the start of trout spawning until the eggs have hatched. In some instances, restrictions may also be applied to bass spawning waters.

2. The approaches to the structure shall consist of stone pads constructed to comply with the aggregate requirements of the General Requirements subsection.

The entire ford approach (where banks were cut) shall be covered with filter cloth and protected with aggregate to a depth of four (4) inches.

3. Fords shall be prohibited when the streambanks are four (4) feet or more in height above the invert of the stream.

4. The approach roads at the cut banks shall be no steeper than 5:1. Spoil material from the banks shall be stored out of the floodplain and stabilized.

5. One layer of filter cloth shall be placed on the streambed, streambanks, and road approaches prior to placing the bedding material on the stream channel or approaches. The filter cloth will be a minimum of six (6) inches and a maximum one foot beyond bedding material.

6. The bedding material shall be coarse aggregate or gabion mattresses filled with coarse aggregate.

7. Aggregate used in ford construction shall meet the minimum requirements of the General Requirements subsection.

8. All fords shall be constructed to minimize the blockage of stream flow and shall allow free flow over the ford. The placing of any material in the waterway bed will cause some upstream ponding. The depth of this ponding will be equivalent to the depth of the material placed within the stream and therefore should be kept to a minimum height. However, in no case will the bedding material be placed deeper than 12 inches or one-half (1/2) the height of the existing banks whichever is smaller.

9. Stabilization: All areas disturbed during ford installation shall be stabilized within 14 calendar days of that disturbance in accordance with the Standard and Specifications for Temporary Critical Area Planting on page 3.3.

10. Ford removal and Clean-Up Requirements

A. Removal: When the temporary structure has served its purpose, excess material used for this structure need not be removed. Care should be taken so that any aggregate left does not create an impoundment or restrict fish passage.

B. Final Clean-Up: Final clean-up shall consist of removal of excess temporary ford materials from the waterway. All materials shall be stored outside the waterway floodplain.

C. Method: Clean up shall be accomplished without construction equipment working in the stream channel.

D. Approach Disposition: The approach slopes of the cut banks shall not be backfilled.

E. Final Stabilization: All areas disturbed during ford removal shall be stabilized within 14 calendar days of that disturbance in accordance with the Standard and Specifications for Permanent Critical Area Planting on page 3.3.

NOTE: Any temporary access crossing shall conform to the technical requirements of this Standard and Specifications as well as any specific requirement imposed by the New York State Department of Environmental Conservation. Permits may be required for streambank disturbance.

Figure 5A.36
Temporary Access Bridge

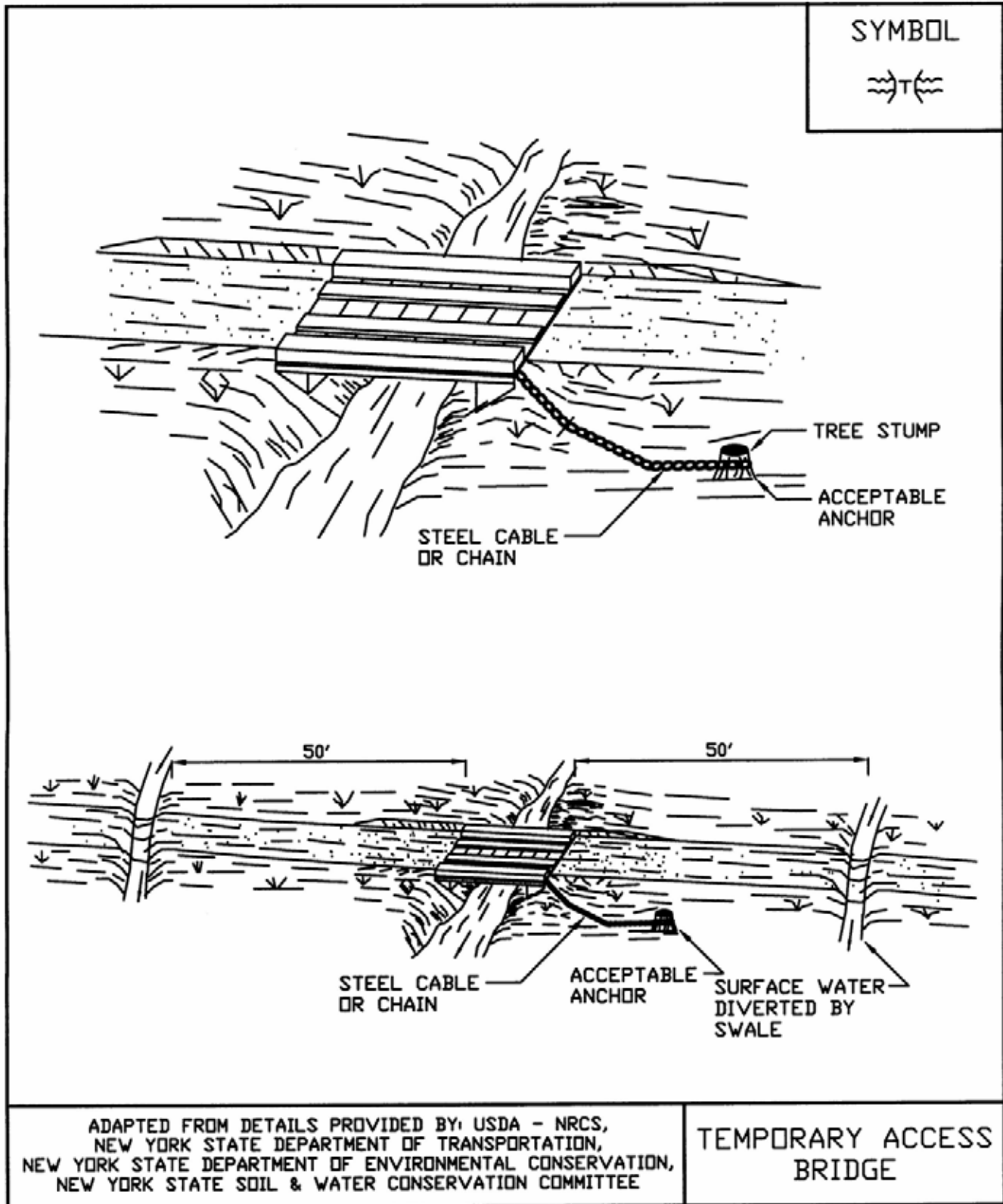
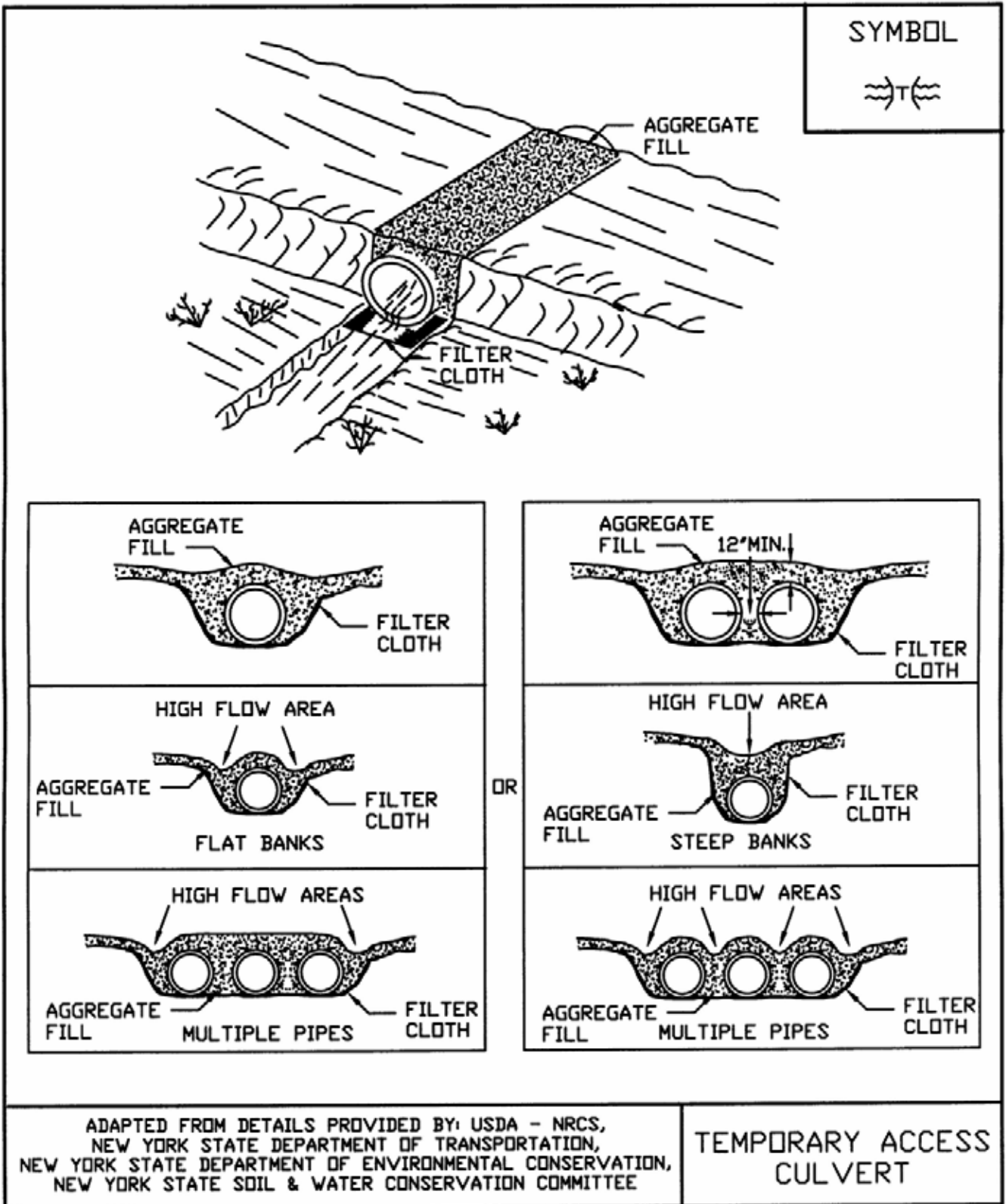
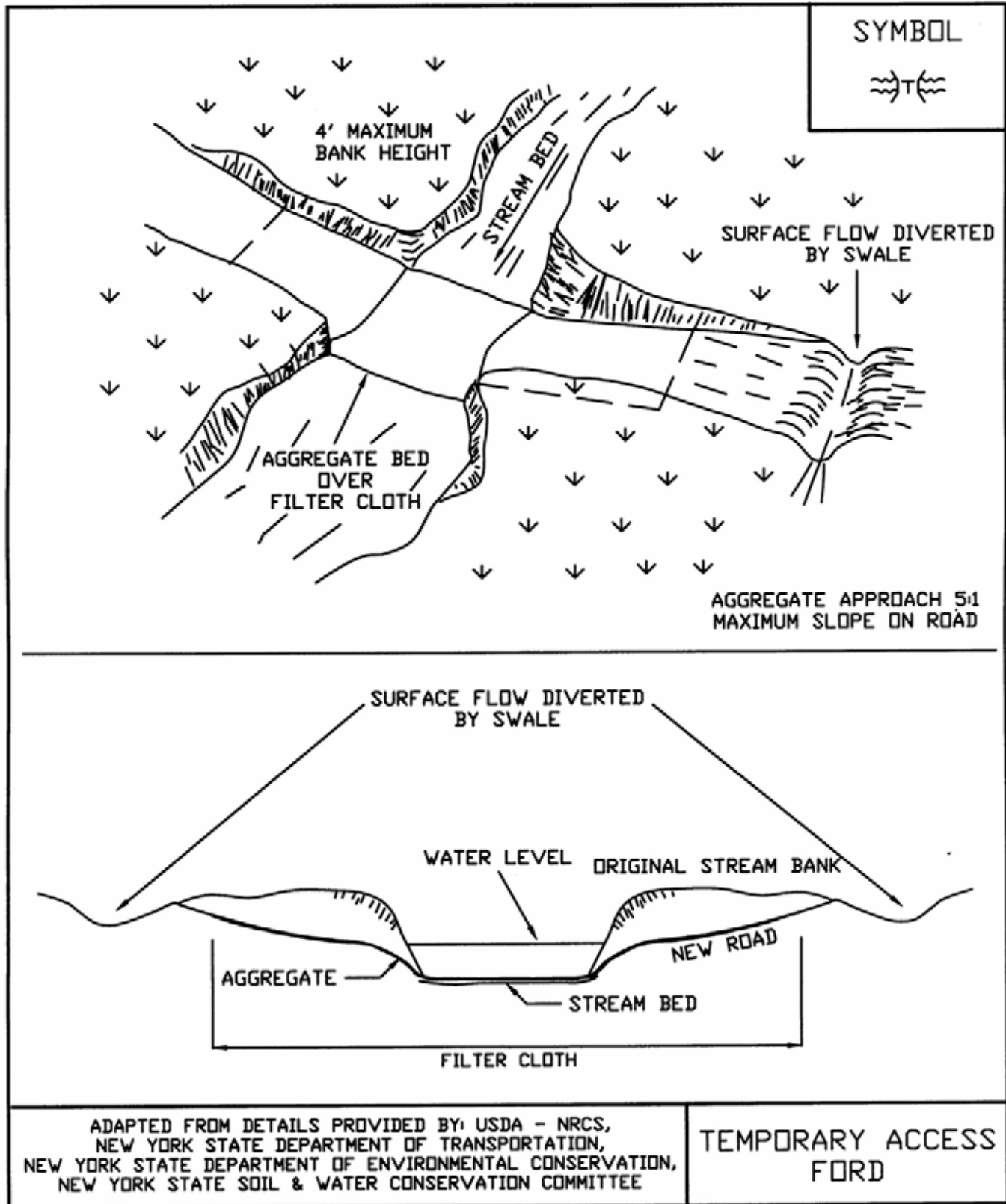

Figure 5A.37
Temporary Access Culvert



**Figure 5A.38
Temporary Access Ford**



STANDARD AND SPECIFICATIONS FOR DUST CONTROL



Definition

The control of dust resulting from land-disturbing activities.

Purpose

To prevent surface and air movement of dust from disturbed soil surfaces that may cause off-site damage, health hazards, and traffic safety problems.

Conditions Where Practice Applies

On construction roads, access points, and other disturbed areas subject to surface dust movement and dust blowing where off-site damage may occur if dust is not controlled.

Design Criteria

Construction operations should be scheduled to minimize the amount of area disturbed at one time. Buffer areas of vegetation should be left where practical. Temporary or permanent stabilization measures shall be installed. No specific design criteria is given; see construction specifications below for common methods of dust control.

Water quality must be considered when materials are selected for dust control. Where there is a potential for the material to wash off to a stream, ingredient information must be provided to the local permitting authority.

Construction Specifications

A. Non-driving Areas – These areas use products and materials applied or placed on soil surfaces to prevent airborne migration of soil particles.

Vegetative Cover – For disturbed areas not subject to traffic, vegetation provides the most practical method of dust control (see Section 3).

Mulch (including gravel mulch) – Mulch offers a fast effective means of controlling dust. This can also include rolled erosion control blankets.

Spray adhesives – These are products generally composed of polymers in a liquid or solid form that are mixed with water to form an emulsion that is sprayed on the soil surface with typical hydroseeding equipment. The mixing ratios and application rates will be in accordance with the manufacturer's recommendations for the specific soils on the site. In no case should the application of these adhesives be made on wet soils or if there is a probability of precipitation within 48 hours of its proposed use. Material Safety Data Sheets will be provided to all applicators and others working with the material.

B. Driving Areas – These areas utilize water, polymer emulsions, and barriers to prevent dust movement from the traffic surface into the air.

Sprinkling – The site may be sprayed with water until the surface is wet. This is especially effective on haul roads and access routes.

Polymer Additives – These polymers are mixed with water and applied to the driving surface by a water truck with a gravity feed drip bar, spray bar or automated distributor truck. The mixing ratios and application rates will be in accordance with the manufacturer's recommendations. Incorporation of the emulsion into the soil will be done to the appropriate depth based on expected traffic. Compaction after incorporation will be by vibratory roller to a minimum of 95%. The prepared surface shall be moist and no application of the polymer will be made if there is a probability of precipitation within 48 hours of its proposed use. Material Safety Data Sheets will be provided to all applicators working with the material.

Barriers – Woven geotextiles can be placed on the driving surface to effectively reduce dust throw and particle migration on haul roads. Stone can also be used for construction roads for effective dust control.

Windbreak – A silt fence or similar barrier can control air currents at intervals equal to ten times the barrier height. Preserve existing wind barrier vegetation as much as practical.

All Stormwater Pollution Prevention Plans must contain the NYS DEC issued “Conditions for Use” and “Application Instructions” for any polymers used on the site. This information can be obtained from the NYS DEC website.

Maintenance

Maintain dust control measures through dry weather periods until all disturbed areas are stabilized.

STANDARD AND SPECIFICATIONS FOR SUMP PIT



Definition

A temporary pit which is constructed to trap and filter water for pumping to a suitable discharge area.

Purpose

To remove excessive water from excavations.

Conditions Where Practice Applies

Sump pits are constructed when water collects during the excavation phase of construction. This practice is particularly useful in urban areas during excavation for building foundations.

Design Criteria

The number of sump pits and their locations shall be determined by the contractor/engineer. A design is not required, but construction should conform to the general criteria outlined on Figure 7A.39 on page 7A.90.

A perforated vertical standpipe is placed in the center of the pit to collect filtered water. Water is then pumped from the center of the pipe to a suitable discharge area.

Discharge of water pumped from the standpipe should be to a sediment trap, sediment basin, or stabilized area, such as a filter strip. If water from the sump pit will be pumped directly to a storm drain system, filter cloth (Mirafi 100X, Poly Filter GB, or a filter cloth with an equivalent sieve size between 40-80) should be wrapped around the standpipe to ensure clean water discharge. It is recommended that $\frac{1}{4}$ to $\frac{1}{2}$ inch hardware cloth be wrapped around and secured to the standpipe prior to attaching the filter cloth. This will increase the rate of water seepage into the standpipe.

**Figure 5A.39
Sump Pit**

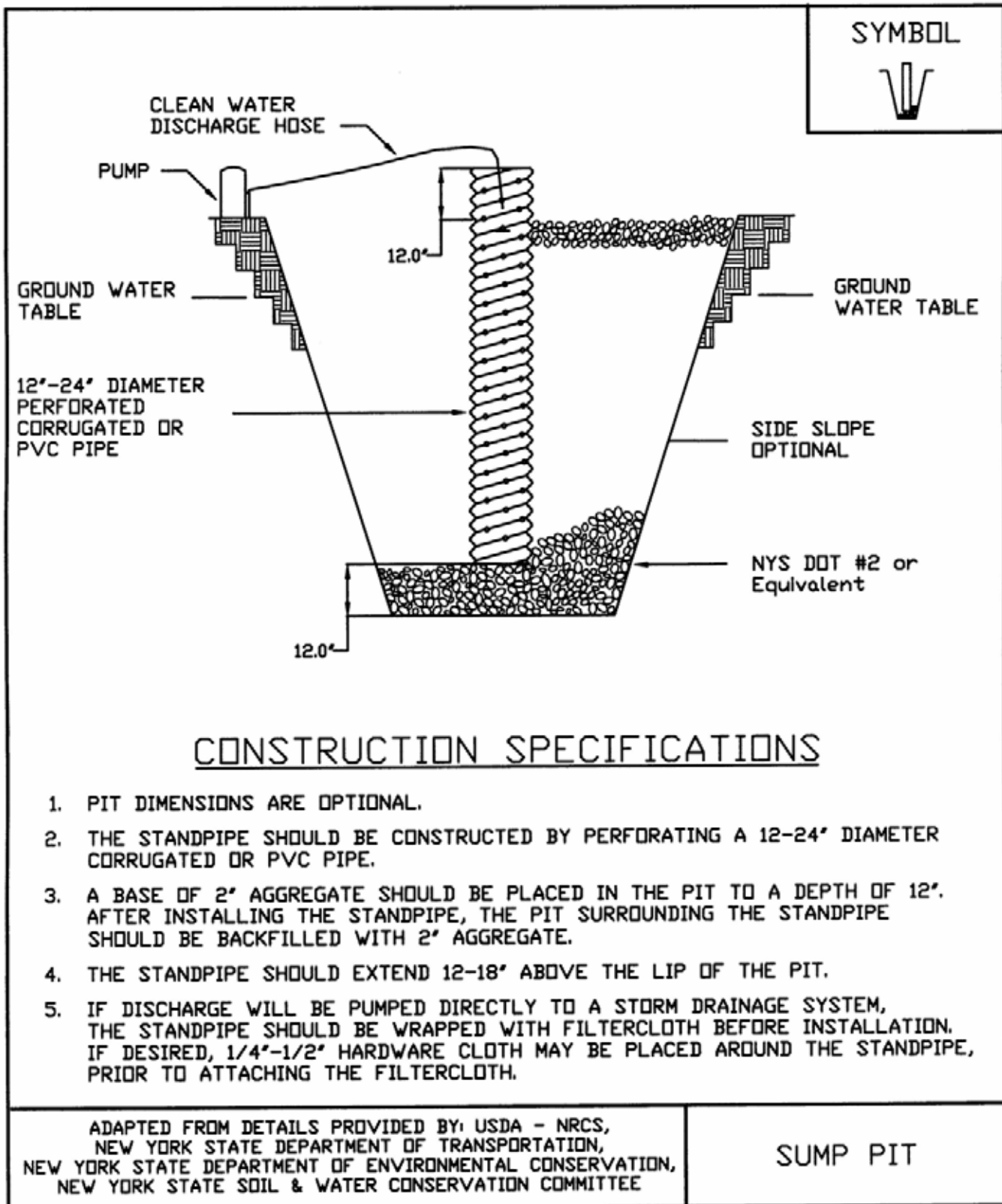

**SECTION 5B
PERMANENT STRUCTURAL MEASURES
FOR
EROSION AND SEDIMENT CONTROL**

CONTENTS

	<u>Page</u>
List of Tables	
List of Figures	
Diversion.....	5B.1
Grassed Waterway.....	5B.11
Lined Waterway or Outlet.....	5B.17
Rock Outlet Protection.....	5B.21
Grade Stabilization Structure.....	5B.31
Paved Flume.....	5B.33
Structural Streambank Protection.....	5B.37
Debris Basin.....	5B.41
Subsurface Drain.....	5B.45
Landgrading.....	5B.49
Surface Roughening.....	5B.55
Riprap Slope Protection.....	5B.57
Retaining Walls.....	5B.61
References	

List of Tables

<u>Table</u>	<u>Name</u>	<u>Page</u>
5B.1	Diversion Maximum Permissible Design Velocities.....	5B.1
5B.2	Retardance Factors for Various Grasses and Legumes.....	5B.2
5B.3	Riprap Gradations.....	5B.38

List of Figures

<u>Figure</u>	<u>Title</u>	<u>Page</u>
5B.1	Diversion Details	5B.3
5B.2	Parabolic Diversion Design, without freeboard-1.....	5B.4
5B.3	Parabolic Diversion Design, without freeboard-2.....	5B.5
5B.4	Parabolic Diversion Design, without freeboard-3.....	5B.6
5B.5	Parabolic Diversion Design, without freeboard-4.....	5B.7
5B.6	Parabolic Diversion Design, without freeboard-5.....	5B.8
5B.7	Parabolic Diversion Design, without freeboard-6.....	5B.9
5B.8	Typical Waterway Cross Sections.....	5B.13
5B.9	Parabolic Waterway Design Chart.....	5B.14
5B.10	Grassed Waterway Details.....	5B.15
5B.11	Determining “n” for Riprap Lined Channel Using Depth of Flow.....	5B.20
5B.12	Outlet Protection Design—Minimum Tailwater Condition.....	5B.25
5B.13	Outlet Protection Design—Maximum Tailwater Condition.....	5B.26
5B.14	Riprap Outlet Protection Example (1).....	5B.27
5B.15	Riprap Outlet Protection Example (2).....	5B.28
5B.16	Riprap Outlet Protection Example (3).....	5B.29
5B.17	Examples of Outlet Structures.....	5B.35
5B.18	Paved Flume Details.....	5B.36
5B.19	Riprap Streambank Protection Details.....	5B.39
5B.20	Structural Streambank Protection Examples.....	5B.40
5B.21	One Year Debris Basin Sediment Capacity.....	5B.44
5B.22	Surface Drain Chart—Corrugated Plastic Drain Tubing.....	5B.48
5B.23	Typical Section of Serrated Cut Slope.....	5B.51
5B.24(1)	Landgrading Details.....	5B.52
5B.24(2)	Landgrading Construction Specifications.....	5B.53
5B.25	Surface Roughening Details.....	5B.56
5B.26	Angle of Repose of Riprap Stones.....	5B.59
5B.27	Typical Rock Slope Protection Details.....	5B.59
5B.28	Retaining Wall Examples.....	5B.63
5B.29	Segmented Retaining Wall.....	5B.64

STANDARD AND SPECIFICATIONS FOR DIVERSION



Definition

A drainage way of parabolic or trapezoidal cross-section with a supporting ridge on the lower side that is constructed across the slope.

Purpose

The purpose of a diversion is to intercept and convey runoff to stable outlets at non-erosive velocities.

Conditions Where Practice Applies

Diversions are used where:

1. Runoff from higher areas has potential for damaging properties, causing erosion, or interfering with, or preventing the establishment of, vegetation on lower areas.
2. Surface and/or shallow subsurface flow is damaging sloping upland.
3. The length of slopes needs to be reduced so that soil loss will be kept to a minimum.

Diversions are only applicable below stabilized or protected areas. Avoid establishment on slopes greater than fifteen percent. Diversions should be used with caution on soils subject to slippage. Construction of diversions shall be in compliance with state drainage and water laws.

Design Criteria

Location

Diversion location shall be determined by considering

outlet conditions, topography, land use, soil type, length of slope, seep planes (when seepage is a problem), and the development layout.

Capacity

Peak rates of runoff values used in determining the capacity requirements shall be computed by TR-55, Urban Hydrology for Small Watersheds, or other appropriate methods.

The constructed diversion shall have capacity to carry, as a minimum, the peak discharge from a ten-year frequency rainfall event with freeboard of not less than 0.3 feet.

Diversions designed to protect homes, schools, industrial buildings, roads, parking lots, and comparable high-risk areas, and those designed to function in connection with other structures, shall have sufficient capacity to carry peak runoff expected from a storm frequency consistent with the hazard involved.

Cross Section

The diversion channel shall be parabolic or trapezoidal in shape. Parabolic Diversion design charts are provided in Figures 5B.2 through 5B.7 on pages 5B.4 to 5B.9. The diversion shall be designed to have stable side slopes. The side slopes shall not be steeper than 2:1 and shall be flat enough to ensure ease of maintenance of the diversion and its protective vegetative cover.

The ridge shall have a minimum width of four feet at the design water elevation; a minimum of 0.3 feet freeboard and a reasonable settlement factor shall be provided.

Velocity and Grade

The permissible velocity for the specified method of stabilization will determine the maximum grade. Maximum permissible velocities of flow for the stated conditions of stabilization shall be as shown in Table 5B.1 on page 5B.2 of this standard.

Diversions are not usually applicable below high sediment producing areas unless land treatment practices or structural measures, designed to prevent damaging accumulations of sediment in the channels, are installed with, or before, the diversions.

Outlets

Each diversion must have an adequate outlet. The outlet may be a grassed waterway, vegetated or paved area, grade stabilization structure, stable watercourse, or subsurface drain outlet. In all cases, the outlet must convey runoff to a point where outflow will not cause damage. Vegetated outlets shall be installed before diversion construction, if needed, to ensure establishment of vegetative cover in the outlet channel.

The design elevation of the water surface in the diversion shall not be lower than the design elevation of the water surface in the outlet at their junction when both are

operating at design flow.

Stabilization

Diversions shall be stabilized in accordance with the following tables.

Construction Specifications

See Figure 5B.1 on page 5B.3 for details.

**Table 5B.1
Diversion Maximum Permissible Design Velocities**

Soil Texture	Retardance and Cover	Permissible Velocity (ft / second) for Selected Channel Vegetation
Sand, Silt, Sandy loam, silty loam, loamy sand (ML, SM, SP, SW)	C-Kentucky 31 tall fescue and Kentucky bluegrass	3.0
	D-Annuals ¹ Small grain (rye, oats, barley, millet) Ryegrass	2.5
Silty clay loam, Sandy clay loam (ML-CL, SC)	C-Kentucky 31 tall fescue and Kentucky bluegrass	4.0
	D-Annuals ¹ Small grain (rye, oats, barley, millet) Ryegrass	3.5
Clay (CL)	C-Kentucky 31 tall fescue and Kentucky bluegrass	5.0
	D-Annuals ¹ Small grain (rye, oats, barley, millet) Ryegrass	4.0

¹ Annuals—Use only as temporary protection until permanent vegetation is established.

Table 5B.2—Retardance Factors for Various Grasses and Legumes

Retardance	Cover	Condition
A	Reed canarygrass.....	Excellent stand, tall (average 36 inches)
B	Smooth bromegrass.....	Good stand, mowed (average 12 to 15 inches)
	Tall fescue.....	Good stand, unmowed (average 18 inches)
	Grass-legume mixture—Timothy, smooth bromegrass, or Orchard grass with birdsfoot trefoil.....	Good stand, uncut (average 20 inches)
	Reed canarygrass.....	Good stand, mowed (average 12 to 15 inches)
	Tall fescue, with birdsfoot trefoil or ladino clover.....	Good stand, uncut (average 18 inches)
C	Redtop.....	Good stand, headed (15 to 20 inches)
	Grass-legume mixture—summer (Orchard grass, redtop, Annual ryegrass, and ladino or white clover).....	Good stand, uncut (6 to 8 inches)
	Kentucky bluegrass.....	Good stand, headed (6 to 12 inches)
D	Red fescue.....	Good stand, headed (12 to 18 inches)
	Grass-legume mixture—fall, spring (Orchard grass, redtop, Annual ryegrass, and white or ladino clover).....	Good stand, uncut (4 to 5 inches)

Figure 5B.1
Diversion

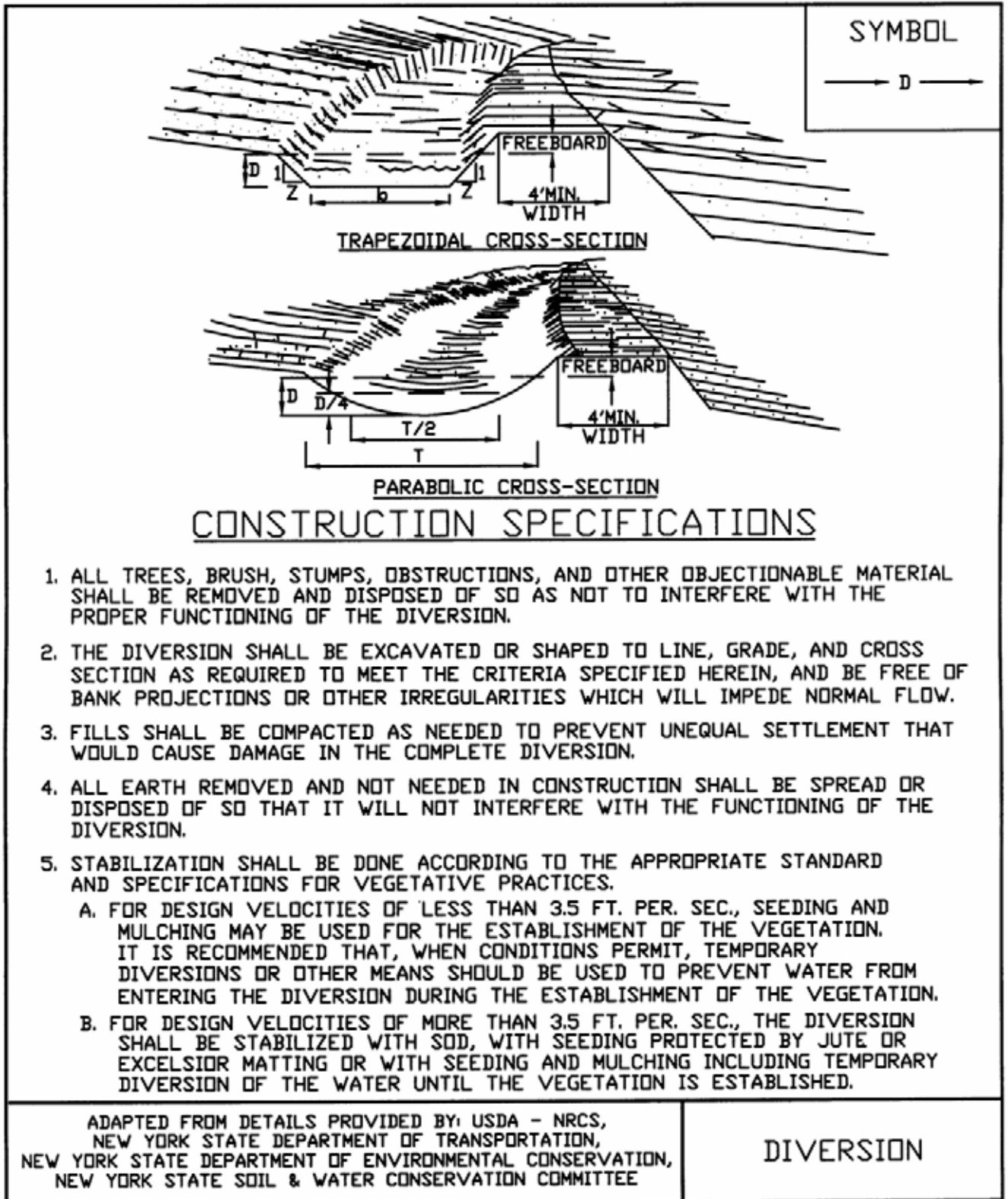

Figure 5B.2
Parabolic Diversion Design, Without Freeboard-1 (USDA - NRCS)

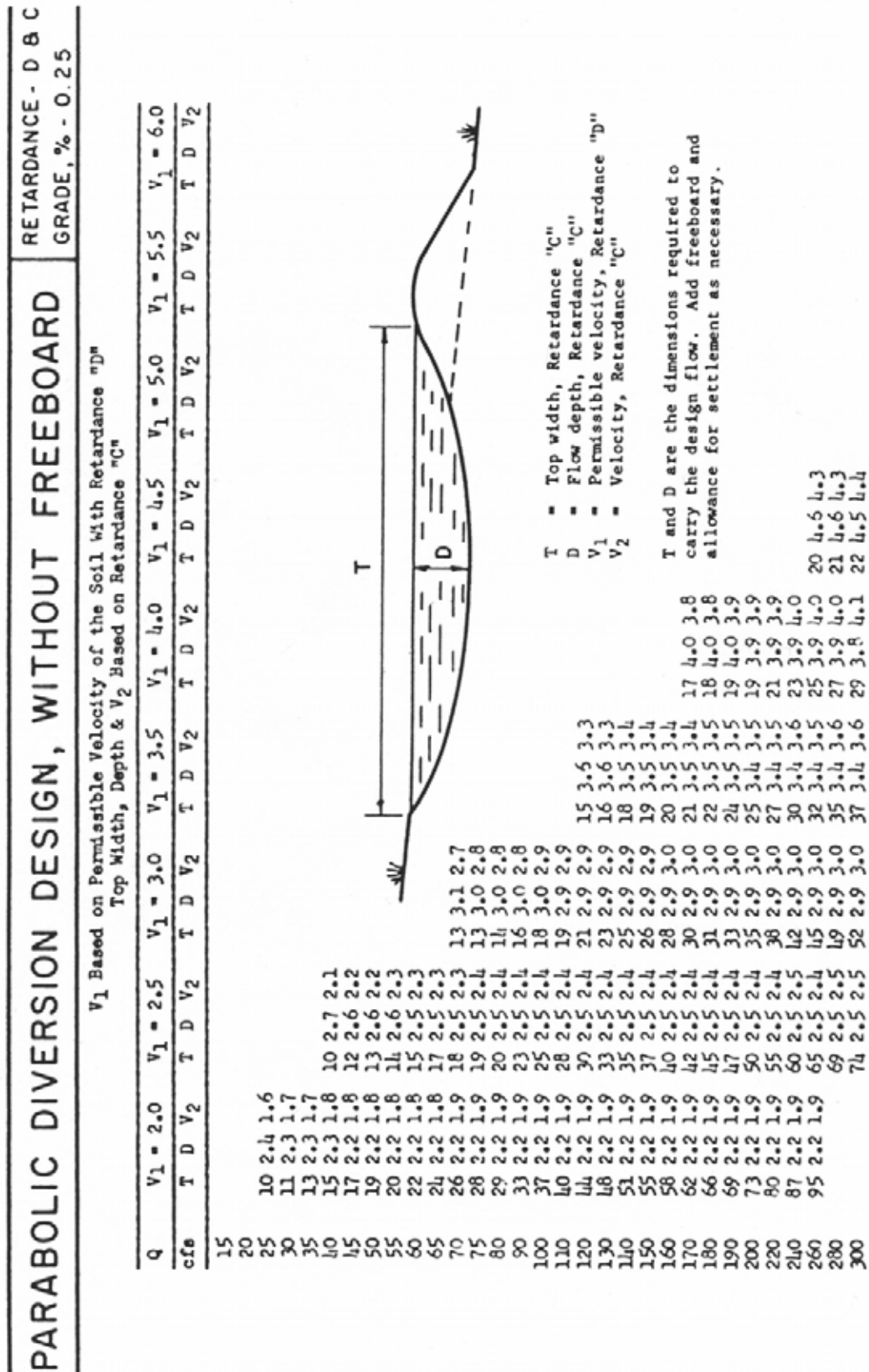

Figure 5B.3
Parabolic Diversion Design, Without Freeboard-2 (USDA - NRCS)

Q		RETARDANCE - D & C GRADE, % - 0.50																																					
		V ₁ = 2.0		V ₁ = 2.5		V ₁ = 3.0		V ₁ = 3.5		V ₁ = 4.0		V ₁ = 4.5		V ₁ = 5.0		V ₁ = 5.5		V ₁ = 6.0																					
cfs	T	D	V ₂	T	D	V ₂	T	D	V ₂	T	D	V ₂	T	D	V ₂	T	D	V ₂	T	D	V ₂	T	D	V ₂	T	D	V ₂	T	D	V ₂	T	D	V ₂	T	D	V ₂			
15	9	1.6	1.6																																				
20	11	1.6	1.7																																				
25	14	1.6	1.7																																				
30	17	1.6	1.7																																				
35	20	1.6	1.7																																				
40	22	1.6	1.7																																				
45	25	1.5	1.7																																				
50	28	1.5	1.7																																				
55	31	1.5	1.7																																				
60	33	1.5	1.7																																				
65	36	1.5	1.8																																				
70	39	1.5	1.7																																				
75	42	1.5	1.8																																				
80	44	1.5	1.8																																				
90	50	1.5	1.8																																				
100	55	1.5	1.8																																				
110	61	1.5	1.8																																				
120	66	1.5	1.8																																				
130	72	1.5	1.8																																				
140	77	1.5	1.8																																				
150	83	1.5	1.8																																				
160	88	1.5	1.8																																				
170	93	1.5	1.8																																				
180	99	1.5	1.8																																				
190																																							
200																																							
220																																							
240																																							
260																																							
280																																							
300																																							

Figure 5B.4
Parabolic Diversion Design, Without Freeboard-3 (USDA - NRCS)

PARABOLIC DIVERSION DESIGN, WITHOUT FREEBOARD										RETARDANCE - D & C GRADE, % - 0.75											
Q	V ₁ Based on Permissible Velocity of the Soil With Retardance "D" Top Width, Depth & V ₂ Based on Retardance "C"										T	D	V ₂	T	D	V ₂	T	D	V ₂		
	V ₁ = 2.0	V ₁ = 2.5	V ₁ = 3.0	V ₁ = 3.5	V ₁ = 4.0	V ₁ = 4.5	V ₁ = 5.0	V ₁ = 5.5	V ₁ = 6.0												
cfs	T	D	V ₂	T	D	V ₂	T	D	V ₂	T	D	V ₂	T	D	V ₂	T	D	V ₂	T	D	V ₂
15	12	1.3	1.5	7	1.6	2.0															
20	16	1.3	1.5	9	1.5	2.2															
25	19	1.3	1.5	11	1.5	2.2															
30	23	1.3	1.5	13	1.5	2.2	8	1.7	2.6												
35	27	1.3	1.5	15	1.5	2.3	11	1.7	2.7	9	1.9	3.1									
40	31	1.3	1.5	18	1.5	2.3	13	1.7	2.8	10	1.9	3.2									
45	35	1.3	1.6	20	1.5	2.3	14	1.7	2.8	11	1.8	3.2									
50	38	1.3	1.6	22	1.5	2.3	16	1.6	2.9	13	1.8	3.3	9	2.2	3.7						
55	42	1.3	1.6	24	1.5	2.3	18	1.6	2.9	14	1.8	3.3	10	2.1	3.8						
60	46	1.3	1.6	26	1.5	2.3	19	1.6	2.8	15	1.8	3.3	11	2.1	3.9						
65	50	1.3	1.6	28	1.5	2.3	21	1.6	2.9	15	1.8	3.3	12	2.1	3.8	10	2.4	4.1			
70	53	1.3	1.6	30	1.5	2.3	22	1.6	2.9	17	1.8	3.3	13	2.1	3.8	11	2.4	4.2			
75	57	1.3	1.6	33	1.5	2.3	24	1.6	2.9	19	1.8	3.3	14	2.1	4.0	11	2.3	4.2			
80	61	1.3	1.6	35	1.5	2.3	25	1.6	2.9	20	1.8	3.4	15	2.1	4.0	12	2.3	4.3			
90	68	1.3	1.6	39	1.5	2.3	28	1.6	2.9	22	1.8	3.4	16	2.1	4.0	13	2.3	4.4	11	2.6	4.6
100	76	1.3	1.6	43	1.5	2.3	32	1.6	2.9	25	1.8	3.4	18	2.1	4.0	15	2.3	4.4	12	2.6	4.8
110	83	1.3	1.6	48	1.5	2.3	35	1.6	2.9	27	1.8	3.4	20	2.0	4.0	16	2.3	4.5	13	2.6	4.8
120	91	1.3	1.6	52	1.5	2.3	38	1.6	2.9	30	1.8	3.4	22	2.1	4.0	18	2.3	4.4	15	2.5	4.8
130	98	1.3	1.6	56	1.5	2.4	41	1.6	2.9	32	1.8	3.4	23	2.1	4.0	19	2.2	4.5	15	2.5	4.9
140				60	1.5	2.4	44	1.6	2.9	34	1.8	3.4	25	2.0	4.1	21	2.3	4.5	17	2.5	4.9
150				65	1.5	2.4	47	1.6	2.9	37	1.8	3.4	27	2.0	4.1	22	2.2	4.5	18	2.5	4.9
160				69	1.5	2.4	50	1.6	2.9	39	1.8	3.4	29	2.0	4.1	24	2.2	4.5	19	2.5	4.9
170				73	1.5	2.4	53	1.6	2.9	42	1.8	3.4	30	2.0	4.1	25	2.2	4.5	20	2.5	5.0
180				77	1.5	2.4	56	1.6	2.9	44	1.8	3.4	32	2.0	4.1	27	2.2	4.5	22	2.5	5.0
190				81	1.5	2.4	60	1.6	2.9	47	1.8	3.4	34	2.0	4.1	29	2.2	4.5	23	2.5	5.0
200				85	1.5	2.4	63	1.6	3.0	49	1.8	3.4	36	2.0	4.1	31	2.2	4.6	24	2.5	5.0
220				94	1.5	2.4	69	1.6	3.0	54	1.8	3.4	39	2.0	4.1	32	2.2	4.6	26	2.5	5.1
240							75	1.6	3.0	59	1.8	3.4	43	2.0	4.1	35	2.2	4.6	29	2.5	5.1
260							81	1.6	3.0	64	1.8	3.4	46	2.0	4.1	38	2.2	4.6	31	2.5	5.1
280							87	1.6	3.0	68	1.8	3.4	50	2.0	4.1	41	2.2	4.6	33	2.5	5.1
300							93	1.6	3.0	73	1.8	3.5	53	2.0	4.1	44	2.2	4.6	35	2.5	5.1

Figure 5B.5
Parabolic Diversion Design, Without Freeboard-4 (USDA - NRCS)

PARABOLIC DIVERSION DESIGN, WITHOUT FREEBOARD										RETARDANCE - D & C GRADE, %- 1.0												
Q	V ₁ = 2.0		V ₁ = 2.5		V ₁ = 3.0		V ₁ = 3.5		V ₁ = 4.0		V ₁ = 4.5		V ₁ = 5.0		V ₁ = 5.5		V ₁ = 6.0					
	T	D	V ₂	T	D	V ₂	T	D	V ₂	T	D	V ₂	T	D	V ₂	T	D	V ₂	T	D	V ₂	
15	13	1.1	1.5	8	1.3	2.0																
20	18	1.1	1.5	11	1.3	2.1	8	1.5	2.6													
25	22	1.1	1.5	14	1.3	2.1	9	1.5	2.6	8	1.6	3.0										
30	27	1.1	1.5	17	1.3	2.1	11	1.5	2.7	9	1.6	3.0										
35	31	1.1	1.5	19	1.3	2.2	13	1.5	2.8	11	1.6	3.1	8	1.8	3.5							
40	35	1.1	1.5	22	1.3	2.1	15	1.4	2.8	12	1.5	3.1	9	1.8	3.7							
45	40	1.1	1.5	25	1.3	2.2	17	1.5	2.8	13	1.6	3.2	10	1.8	3.7							
50	44	1.1	1.5	28	1.3	2.2	19	1.4	2.8	15	1.5	3.2	11	1.8	3.7							
55	48	1.1	1.5	30	1.3	2.2	20	1.4	2.8	16	1.5	3.3	12	1.8	3.7							
60	53	1.1	1.5	33	1.3	2.2	22	1.4	2.8	18	1.5	3.3	14	1.7	3.8							
65	57	1.1	1.5	36	1.3	2.2	24	1.4	2.8	19	1.5	3.3	15	1.7	3.8							
70	61	1.1	1.5	38	1.3	2.2	26	1.4	2.8	21	1.5	3.3	16	1.7	3.9	9	2.0	4.2				
75	66	1.1	1.5	41	1.3	2.2	28	1.4	2.9	22	1.5	3.3	17	1.7	3.9	10	2.0	4.3				
80	70	1.1	1.5	44	1.3	2.2	29	1.4	2.9	24	1.5	3.3	18	1.7	3.9	11	2.0	4.3				
85	74	1.1	1.5	47	1.3	2.2	31	1.4	2.9	27	1.5	3.3	20	1.7	3.9	13	2.0	4.5				
90	79	1.1	1.5	51	1.3	2.2	33	1.4	2.9	29	1.5	3.3	22	1.7	3.9	15	1.9	4.5				
95	83	1.1	1.5	55	1.3	2.2	37	1.4	2.9	32	1.5	3.3	24	1.7	3.9	17	1.9	4.5				
100	87	1.1	1.5	60	1.3	2.2	40	1.4	2.9	35	1.5	3.3	27	1.7	4.0	20	1.9	4.6				
110	96	1.1	1.5	65	1.3	2.2	44	1.4	2.9	38	1.5	3.3	29	1.7	4.0	22	1.9	4.6				
120				71	1.3	2.2	47	1.4	2.9	41	1.5	3.3	31	1.7	4.0	24	1.9	4.6				
130				76	1.3	2.2	51	1.4	2.9	44	1.5	3.3	33	1.7	4.0	25	1.9	4.6				
140				81	1.3	2.2	55	1.4	2.9	47	1.5	3.3	35	1.7	4.0	27	1.9	4.6				
150				87	1.3	2.2	58	1.4	2.9	50	1.5	3.3	38	1.7	4.0	29	1.9	4.6				
160				92	1.3	2.2	62	1.4	2.9	53	1.5	3.3	40	1.7	4.0	30	1.9	4.6				
170				97	1.3	2.2	65	1.4	2.9	55	1.5	3.3	42	1.7	4.0	32	1.9	4.6				
180							69	1.4	2.9	58	1.5	3.3	44	1.7	4.0	34	1.9	4.7				
190							72	1.4	2.9	61	1.5	3.3	46	1.7	4.0	37	1.9	4.6				
200							80	1.4	2.9	64	1.5	3.3	48	1.7	4.0	40	1.9	4.6				
210							87	1.4	2.9	70	1.5	3.3	53	1.7	4.0	44	1.9	4.7				
220							94	1.4	2.9	76	1.5	3.3	57	1.7	4.0	48	1.9	4.7				
240										81	1.5	3.4	61	1.7	4.0	47	1.9	4.7				
260										87	1.5	3.4	66	1.7	4.0	50	1.9	4.7				
280																						
300																						

Figure 5B.6
Parabolic Diversion Design, Without Freeboard-5 (USDA - NRCS)

Q		RETARDANCE - D & C GRADE, % - 1.5											
		V ₁ = 2.0	V ₁ = 2.5	V ₁ = 3.0	V ₁ = 3.5	V ₁ = 4.0	V ₁ = 4.5	V ₁ = 5.0	V ₁ = 5.5	V ₁ = 6.0	T	D	V ₂
cfs	T D V ₂	T D V ₂	T D V ₂	T D V ₂	T D V ₂	T D V ₂	T D V ₂	T D V ₂	T D V ₂	T D V ₂	T D V ₂	T D V ₂	T D V ₂
15	17 0.9 1.4	11 1.1 1.9	8 1.2 2.4	7 1.4 3.0	6 1.5 3.4	7 1.6 4.0	7 1.6 4.1	7 1.6 4.2	7 1.6 4.3	7 1.6 4.4	7 1.6 4.5	7 1.6 4.6	7 1.6 4.7
20	23 0.9 1.4	15 1.0 1.9	10 1.2 2.5	8 1.4 3.2	7 1.5 3.6	8 1.6 4.2	8 1.6 4.3	8 1.6 4.4	8 1.6 4.5	8 1.6 4.6	8 1.6 4.7	8 1.6 4.8	8 1.6 4.9
25	28 0.9 1.4	19 1.0 1.9	12 1.2 2.6	10 1.3 3.2	8 1.5 3.6	9 1.6 4.2	9 1.6 4.3	9 1.6 4.4	9 1.6 4.5	9 1.6 4.6	9 1.6 4.7	9 1.6 4.8	9 1.6 4.9
30	34 0.9 1.4	22 1.0 1.9	15 1.2 2.6	12 1.3 3.3	10 1.4 3.7	10 1.5 4.3	10 1.5 4.4	10 1.5 4.5	10 1.5 4.6	10 1.5 4.7	10 1.5 4.8	10 1.5 4.9	10 1.5 5.0
35	40 0.9 1.4	26 1.0 2.0	17 1.1 2.6	14 1.3 3.4	11 1.4 3.8	11 1.5 4.4	11 1.5 4.5	11 1.5 4.6	11 1.5 4.7	11 1.5 4.8	11 1.5 4.9	11 1.5 5.0	11 1.5 5.1
40	45 0.9 1.4	30 1.0 1.9	20 1.2 2.6	15 1.3 3.4	12 1.4 3.9	12 1.5 4.5	12 1.5 4.6	12 1.5 4.7	12 1.5 4.8	12 1.5 4.9	12 1.5 5.0	12 1.5 5.1	12 1.5 5.2
45	51 0.9 1.4	33 1.0 2.0	22 1.1 2.6	17 1.3 3.4	13 1.4 3.9	13 1.5 4.5	13 1.5 4.6	13 1.5 4.7	13 1.5 4.8	13 1.5 4.9	13 1.5 5.0	13 1.5 5.1	13 1.5 5.2
50	56 0.9 1.4	37 1.0 2.0	25 1.1 2.7	19 1.3 3.4	14 1.4 3.9	14 1.5 4.5	14 1.5 4.6	14 1.5 4.7	14 1.5 4.8	14 1.5 4.9	14 1.5 5.0	14 1.5 5.1	14 1.5 5.2
55	62 0.9 1.5	41 1.0 2.0	27 1.1 2.6	20 1.3 3.4	15 1.4 3.9	15 1.5 4.5	15 1.5 4.6	15 1.5 4.7	15 1.5 4.8	15 1.5 4.9	15 1.5 5.0	15 1.5 5.1	15 1.5 5.2
60	67 0.9 1.5	44 1.0 2.0	30 1.1 2.7	22 1.3 3.4	16 1.4 3.9	16 1.5 4.5	16 1.5 4.6	16 1.5 4.7	16 1.5 4.8	16 1.5 4.9	16 1.5 5.0	16 1.5 5.1	16 1.5 5.2
65	73 0.9 1.5	48 1.0 2.0	32 1.1 2.7	24 1.3 3.4	18 1.4 3.9	18 1.5 4.5	18 1.5 4.6	18 1.5 4.7	18 1.5 4.8	18 1.5 4.9	18 1.5 5.0	18 1.5 5.1	18 1.5 5.2
70	78 0.9 1.5	51 1.0 2.0	34 1.1 2.7	25 1.3 3.4	19 1.4 3.9	19 1.5 4.5	19 1.5 4.6	19 1.5 4.7	19 1.5 4.8	19 1.5 4.9	19 1.5 5.0	19 1.5 5.1	19 1.5 5.2
75	83 0.9 1.5	55 1.0 2.0	37 1.1 2.7	27 1.3 3.4	21 1.4 3.9	21 1.5 4.5	21 1.5 4.6	21 1.5 4.7	21 1.5 4.8	21 1.5 4.9	21 1.5 5.0	21 1.5 5.1	21 1.5 5.2
80	89 0.9 1.5	59 1.0 2.0	39 1.1 2.7	29 1.3 3.4	22 1.4 3.9	22 1.5 4.5	22 1.5 4.6	22 1.5 4.7	22 1.5 4.8	22 1.5 4.9	22 1.5 5.0	22 1.5 5.1	22 1.5 5.2
90	100 0.9 1.5	66 1.0 2.0	44 1.1 2.7	30 1.3 3.5	25 1.4 3.9	25 1.5 4.5	25 1.5 4.6	25 1.5 4.7	25 1.5 4.8	25 1.5 4.9	25 1.5 5.0	25 1.5 5.1	25 1.5 5.2
100		73 1.0 2.0	49 1.1 2.7	33 1.3 3.5	27 1.4 3.9	27 1.5 4.5	27 1.5 4.6	27 1.5 4.7	27 1.5 4.8	27 1.5 4.9	27 1.5 5.0	27 1.5 5.1	27 1.5 5.2
110		80 1.0 2.0	54 1.1 2.7	37 1.3 3.5	30 1.4 3.9	30 1.5 4.5	30 1.5 4.6	30 1.5 4.7	30 1.5 4.8	30 1.5 4.9	30 1.5 5.0	30 1.5 5.1	30 1.5 5.2
120		87 1.0 2.0	58 1.1 2.7	40 1.3 3.5	33 1.4 3.9	33 1.5 4.5	33 1.5 4.6	33 1.5 4.7	33 1.5 4.8	33 1.5 4.9	33 1.5 5.0	33 1.5 5.1	33 1.5 5.2
130		95 1.0 2.0	63 1.1 2.7	43 1.3 3.5	35 1.4 3.9	35 1.5 4.5	35 1.5 4.6	35 1.5 4.7	35 1.5 4.8	35 1.5 4.9	35 1.5 5.0	35 1.5 5.1	35 1.5 5.2
140			68 1.1 2.7	47 1.3 3.5	38 1.4 3.9	38 1.5 4.5	38 1.5 4.6	38 1.5 4.7	38 1.5 4.8	38 1.5 4.9	38 1.5 5.0	38 1.5 5.1	38 1.5 5.2
150			73 1.1 2.7	50 1.3 3.5	41 1.4 3.9	41 1.5 4.5	41 1.5 4.6	41 1.5 4.7	41 1.5 4.8	41 1.5 4.9	41 1.5 5.0	41 1.5 5.1	41 1.5 5.2
160			78 1.1 2.7	53 1.3 3.5	43 1.4 3.9	43 1.5 4.5	43 1.5 4.6	43 1.5 4.7	43 1.5 4.8	43 1.5 4.9	43 1.5 5.0	43 1.5 5.1	43 1.5 5.2
170			82 1.1 2.7	56 1.3 3.5	46 1.4 3.9	46 1.5 4.5	46 1.5 4.6	46 1.5 4.7	46 1.5 4.8	46 1.5 4.9	46 1.5 5.0	46 1.5 5.1	46 1.5 5.2
180			87 1.1 2.7	60 1.3 3.5	49 1.4 3.9	49 1.5 4.5	49 1.5 4.6	49 1.5 4.7	49 1.5 4.8	49 1.5 4.9	49 1.5 5.0	49 1.5 5.1	49 1.5 5.2
190			92 1.1 2.7	63 1.3 3.5	51 1.4 3.9	51 1.5 4.5	51 1.5 4.6	51 1.5 4.7	51 1.5 4.8	51 1.5 4.9	51 1.5 5.0	51 1.5 5.1	51 1.5 5.2
200			97 1.1 2.7	66 1.3 3.5	54 1.4 3.9	54 1.5 4.5	54 1.5 4.6	54 1.5 4.7	54 1.5 4.8	54 1.5 4.9	54 1.5 5.0	54 1.5 5.1	54 1.5 5.2
220				73 1.3 3.5	59 1.4 4.0	59 1.5 4.5	59 1.5 4.6	59 1.5 4.7	59 1.5 4.8	59 1.5 4.9	59 1.5 5.0	59 1.5 5.1	59 1.5 5.2
240				79 1.3 3.5	65 1.4 4.0	65 1.5 4.5	65 1.5 4.6	65 1.5 4.7	65 1.5 4.8	65 1.5 4.9	65 1.5 5.0	65 1.5 5.1	65 1.5 5.2
260				86 1.3 3.5	70 1.4 4.0	70 1.5 4.5	70 1.5 4.6	70 1.5 4.7	70 1.5 4.8	70 1.5 4.9	70 1.5 5.0	70 1.5 5.1	70 1.5 5.2
280				92 1.3 3.5	75 1.4 4.0	75 1.5 4.5	75 1.5 4.6	75 1.5 4.7	75 1.5 4.8	75 1.5 4.9	75 1.5 5.0	75 1.5 5.1	75 1.5 5.2
300				99 1.3 3.5	81 1.4 4.0	81 1.5 4.5	81 1.5 4.6	81 1.5 4.7	81 1.5 4.8	81 1.5 4.9	81 1.5 5.0	81 1.5 5.1	81 1.5 5.2

Figure 5B.7

Parabolic Diversion Design, Without Freeboard-6 (USDA - NRCS)

		PARABOLIC DIVERSION DESIGN, WITHOUT FREEBOARD																RETARDANCE - D & C			
																		GRADE, % - 2.0			
Q	cfs	V ₁ = 2.0		V ₁ = 2.5		V ₁ = 3.0		V ₁ = 3.5		V ₁ = 4.0		V ₁ = 4.5		V ₁ = 5.0		V ₁ = 5.5		V ₁ = 6.0			
		T	D	T	D	T	D	T	D	T	D	T	D	T	D	T	D	T	D	T	D
15	21	0.8	1.3	13	0.9	1.9	9	1.0	2.4	7	1.2	2.9	7	1.3	3.5	5	1.4	3.8			
20	28	0.8	1.3	17	0.9	1.9	12	1.0	2.4	9	1.1	3.0	8	1.3	3.7	7	1.4	4.0			
25	35	0.8	1.3	21	0.9	1.9	15	1.0	2.4	11	1.1	3.0	8	1.3	3.7	7	1.4	4.0			
30	41	0.8	1.3	26	0.9	1.9	18	1.0	2.5	13	1.1	3.0	10	1.2	3.7	8	1.3	4.2	7	1.5	4.7
35	48	0.8	1.4	30	0.9	1.9	22	1.0	2.4	15	1.1	3.1	11	1.2	3.8	9	1.3	4.2	8	1.5	4.7
40	55	0.8	1.3	34	0.9	1.9	25	1.0	2.5	18	1.1	3.1	13	1.2	3.8	11	1.3	4.3	9	1.5	4.7
45	62	0.8	1.4	38	0.9	1.9	28	1.0	2.5	20	1.1	3.1	14	1.2	3.8	12	1.3	4.3	10	1.4	4.8
50	68	0.8	1.4	42	0.9	1.9	31	1.0	2.5	22	1.1	3.1	16	1.2	3.9	13	1.3	4.3	11	1.4	4.8
55	75	0.8	1.4	46	0.9	1.9	34	1.0	2.5	24	1.1	3.1	17	1.2	3.9	14	1.3	4.3	12	1.4	4.9
60	82	0.8	1.4	51	0.9	1.9	37	1.0	2.5	26	1.1	3.1	19	1.2	3.9	16	1.3	4.4	13	1.4	4.9
65	88	0.8	1.4	55	0.9	1.9	40	1.0	2.5	28	1.1	3.1	21	1.2	3.9	17	1.3	4.4	14	1.4	4.9
70	95	0.8	1.4	59	0.9	1.9	43	1.0	2.5	30	1.1	3.1	22	1.2	3.9	18	1.3	4.4	15	1.4	4.9
75	63	0.9	1.9	63	0.9	1.9	46	1.0	2.5	32	1.1	3.2	24	1.2	3.9	20	1.3	4.4	16	1.4	5.0
80	67	0.9	2.0	67	0.9	2.0	48	1.0	2.5	35	1.1	3.1	25	1.2	3.9	21	1.3	4.4	17	1.4	4.9
90	75	0.9	2.0	75	0.9	2.0	54	1.0	2.5	39	1.1	3.2	28	1.2	3.9	23	1.3	4.4	19	1.4	4.9
100	83	0.9	2.0	83	0.9	2.0	60	1.0	2.5	43	1.1	3.2	31	1.2	3.9	26	1.3	4.4	21	1.4	5.0
110	92	0.9	2.0	92	0.9	2.0	66	1.0	2.5	47	1.1	3.2	34	1.2	3.9	28	1.3	4.4	23	1.4	5.0
120	100	0.9	2.0	100	0.9	2.0	72	1.0	2.5	52	1.1	3.2	38	1.2	3.9	31	1.3	4.4	26	1.4	5.0
130	78	1.0	2.5	78	1.0	2.5	56	1.1	3.2	56	1.1	3.2	41	1.2	3.9	34	1.3	4.5	28	1.4	5.0
140	84	1.0	2.5	84	1.0	2.5	60	1.1	3.2	60	1.1	3.2	44	1.2	4.0	36	1.3	4.5	30	1.4	5.0
150	90	1.0	2.5	90	1.0	2.5	64	1.1	3.2	64	1.1	3.2	47	1.2	4.0	39	1.3	4.5	32	1.4	5.0
160	96	1.0	2.5	96	1.0	2.5	69	1.1	3.2	69	1.1	3.2	50	1.2	4.0	41	1.3	4.5	34	1.4	5.1
170	73	1.1	3.2	73	1.1	3.2	73	1.1	3.2	73	1.1	3.2	53	1.2	4.0	44	1.3	4.5	36	1.4	5.1
180	77	1.1	3.2	77	1.1	3.2	77	1.1	3.2	77	1.1	3.2	56	1.2	4.0	46	1.3	4.5	38	1.4	5.0
190	81	1.1	3.2	81	1.1	3.2	81	1.1	3.2	81	1.1	3.2	59	1.2	4.0	49	1.3	4.5	40	1.4	5.0
200	85	1.1	3.2	85	1.1	3.2	85	1.1	3.2	85	1.1	3.2	62	1.2	4.0	51	1.3	4.5	42	1.4	5.0
220	94	1.1	3.2	94	1.1	3.2	94	1.1	3.2	94	1.1	3.2	68	1.2	4.0	56	1.3	4.5	46	1.4	5.0
240	74	1.2	4.0	74	1.2	4.0	74	1.2	4.0	74	1.2	4.0	74	1.2	4.0	61	1.3	4.5	51	1.4	5.1
260	80	1.2	4.0	80	1.2	4.0	80	1.2	4.0	80	1.2	4.0	80	1.2	4.0	66	1.3	4.5	55	1.4	5.1
280	86	1.2	4.0	86	1.2	4.0	86	1.2	4.0	86	1.2	4.0	86	1.2	4.0	71	1.3	4.5	59	1.4	5.1
300	92	1.2	4.0	92	1.2	4.0	92	1.2	4.0	92	1.2	4.0	92	1.2	4.0	76	1.3	4.5	63	1.4	5.1

STANDARD AND SPECIFICATIONS FOR GRASSED WATERWAY



Definition

A natural or man-made channel of parabolic or trapezoidal cross-section that is below adjacent ground level and is stabilized by suitable vegetation. The flow channel is normally wide and shallow and conveys the runoff down the slope.

Purpose

The purpose of a grassed waterway is to convey runoff without causing damage by erosion.

Conditions Where Practice Applies

Grass waterways are used where added vegetative protection is needed to control erosion resulting from concentrated runoff.

Design Criteria

Capacity

The minimum capacity shall be that required to confine the peak rate of runoff expected from a 10-year frequency rainfall event or a higher frequency corresponding to the hazard involved. This requirement for confinement may be waived on slopes of less than one (1) percent where out-of-bank flow will not cause erosion or property damage.

Peak rates of runoff values used in determining the capacity requirements shall be computed by [TR-55, Urban Hydrology for Small Watersheds](#), or other appropriate methods.

Where there is base flow, it shall be handled by a stone

center, subsurface drain, or other suitable means since sustained wetness usually prevents adequate vegetative cover. The cross-sectional area of the stone center or subsurface drain size to be provided shall be determined by using a flow rate of 0.1 cfs/acre or by actual measurement of the maximum base flow.

Velocity

Please see Table 5B.1, Diversion Maximum Permissible Design Velocities, for seed, soil, and velocity variables.

Cross Section

The design water surface elevation of a grassed waterway receiving water from diversions or other tributary channels shall be equal to or less than the design water surface elevation in the diversion or other tributary channels.

The top width of parabolic waterways shall not exceed 30 feet and the bottom width of trapezoidal waterways shall not exceed 15 feet unless multiple or divided waterways, stone center, or other means are provided to control meandering of low flows.

Structural Measures

In cases where grade or erosion problems exist, special control measures may be needed such as lined waterways (5B.17), or grade stabilization measures (5B.31). Where needed, these measures will be supported by adequate design computations. For typical cross sections of waterways with riprap sections or stone centers, refer to Figure 5B.8 on page 5B.13.

The design procedures for parabolic and trapezoidal channels are available in the NRCS Engineering Field Handbook; Figure 5B.9 on page 5B.14 also provides a design chart for parabolic waterway.

Outlets

Each waterway shall have a stable outlet. The outlet may be another waterway, a stabilized open channel, grade stabilization structure, etc. In all cases, the outlet must discharge in such a manner as not to cause erosion. Outlets shall be constructed and stabilized prior to the operation of the waterway.

Stabilization

Waterways shall be stabilized in accordance with the appropriate vegetative stabilization standard and specifications, and will be dependent on such factors as slope, soil class, etc.

Construction Specifications

See Figure 5B.10 on page 5B.15 for details.

Figure 5B.8
Typical Waterway Cross Sections

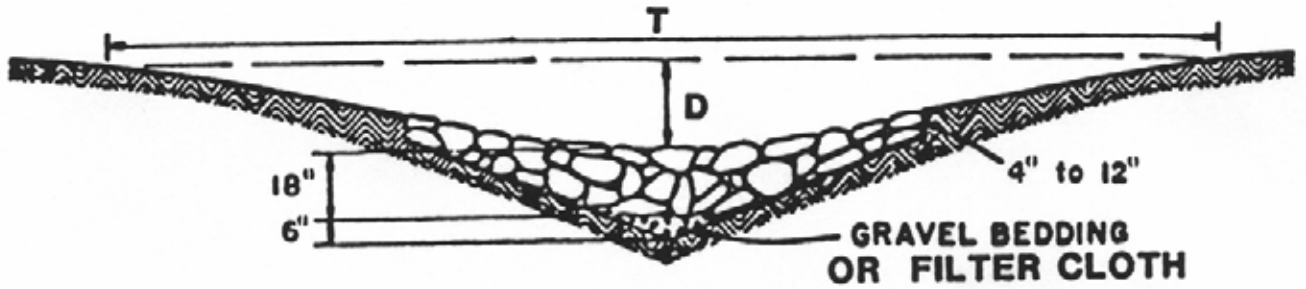

Waterway with stone center drain. "V" section shaped by motor grader.

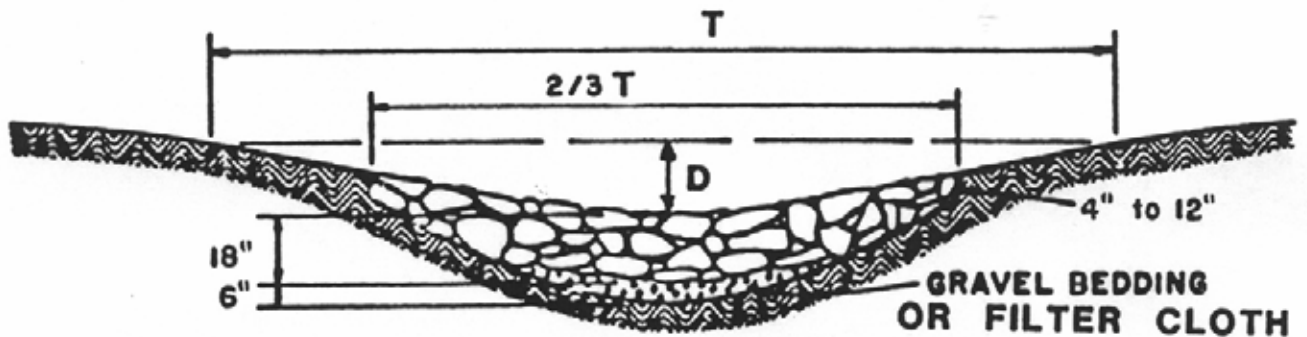

Waterway with stone center drain. Rounded section shaped by bulldozer.

Figure 5B.9
Parabolic Waterway Design Chart (USDA - NRCS)

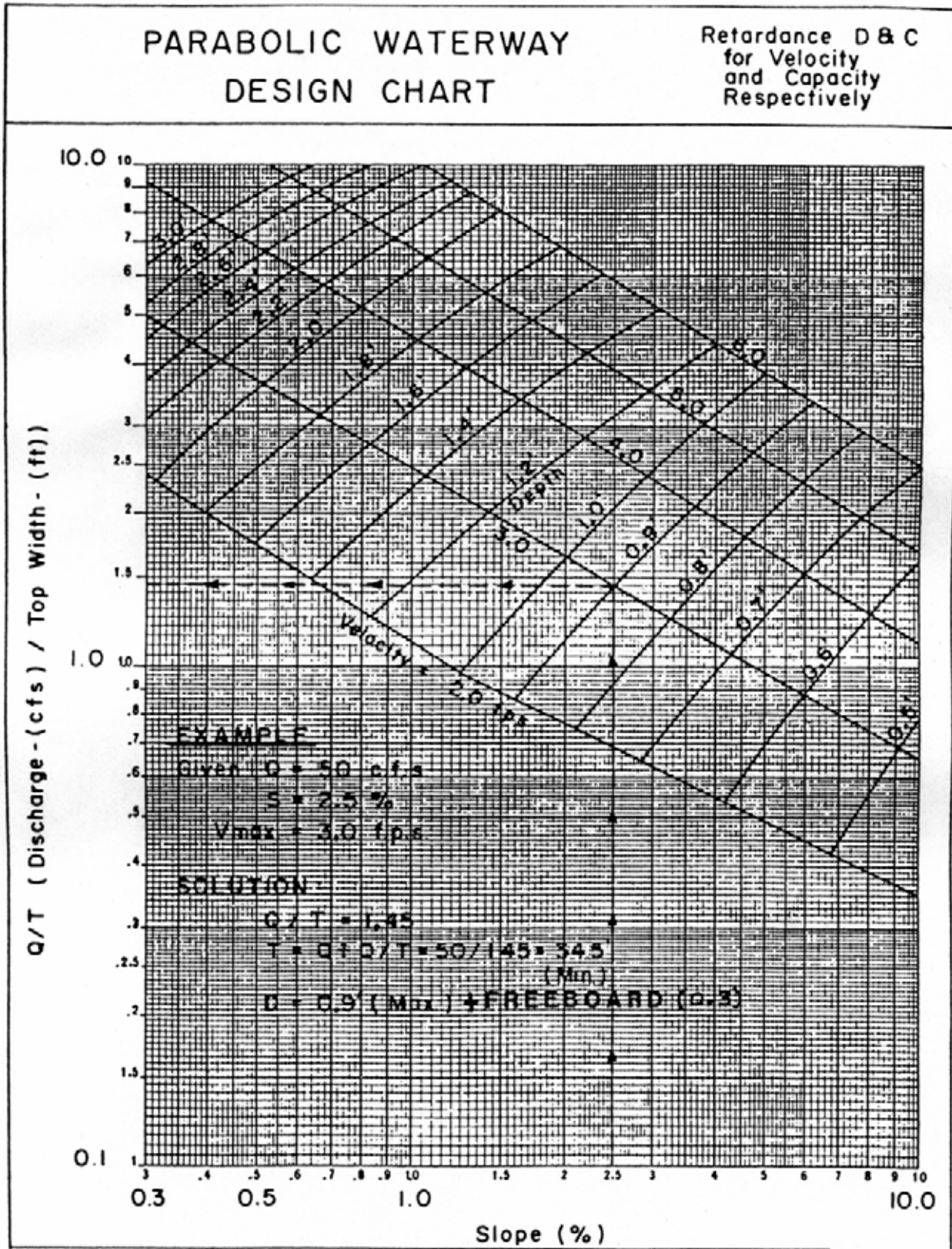

**Figure 5B.10
Grassed Waterway**

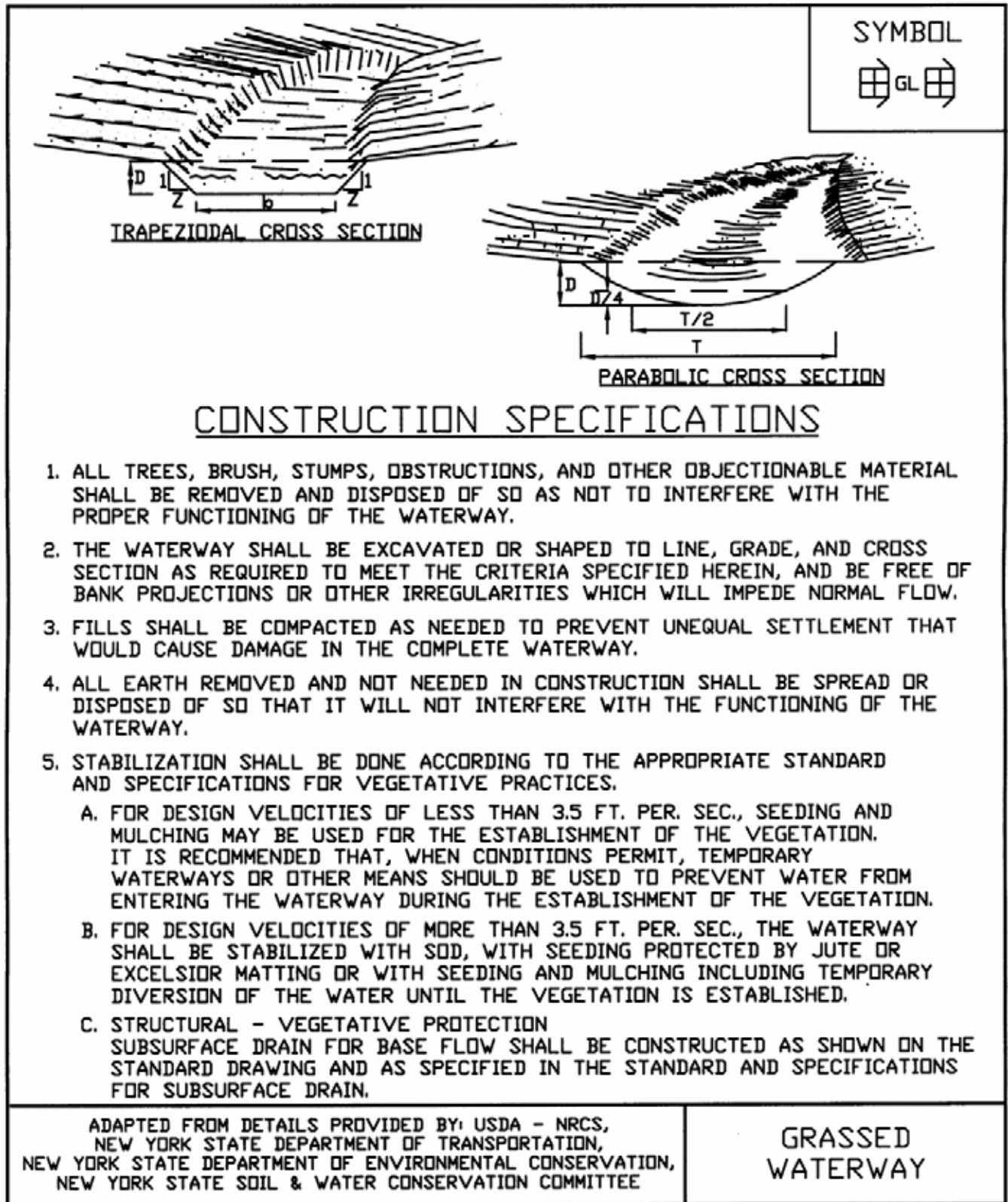

STANDARD AND SPECIFICATIONS FOR LINED WATERWAY OR OUTLET



Definition

A waterway or outlet with a lining of concrete, stone, or other permanent material. The lined section extends up the side slopes to the designed depth. The earth above the permanent lining may be vegetated or otherwise protected.

Purpose

To provide for the disposal of concentrated runoff without damage from erosion or flooding, where grassed waterways would be inadequate due to high velocities.

Scope

This standard applies to waterways or outlets with linings of cast-in-place concrete, flagstone mortared in place, rock riprap, gabions, or similar permanent linings. It does not apply to irrigation ditch or canal linings, grassed waterways with stone centers or small lined sections that carry prolonged low flows, or to reinforced concrete channels. The maximum capacity of the waterway flowing at design depth shall not exceed 100 cubic feet per second.

Conditions Where Practice Applies

This practice applies where the following or similar conditions exist:

1. Concentrated runoff is such that a lining is required to control erosion.
2. Steep grades, wetness, prolonged base flow, seepage, or piping that would cause erosion.

3. The location is such that damage from use by people or animals precludes use of vegetated waterways or outlets.
4. Soils are highly erosive or other soil and climate conditions preclude using vegetation.
5. High value property or adjacent facilities warrant the extra cost to contain design runoff in a limited space.

Design Criteria

Capacity

1. The minimum capacity shall be adequate to carry the peak rate of runoff from a 10-year, 24-hour storm. Velocity shall be computed using Manning's equation with a coefficient of roughness "n" as follows:

<u>Lined Material</u>	<u>"n"</u>
Concrete (Type):	
Trowel Finish	0.015
Float Finish	0.019
Gunitite	0.019
Flagstone	0.022
Riprap	Determine from Figure 5B.11 on page 5B.19
Gabion	0.030

2. Riprap gradation and filter (bedding) are generally designed in accordance with criteria set forth in the National Cooperative Highway Research Program Report 108, available from the University Microfilm International, 300 N. Zeeb Road, Ann Arbor, Michigan 48106, Publication No. PB-00839; or the Hydraulic Engineering Circular No. 11, prepared by the U.S. Bureau of Public Roads, available from Federal Highway Administration, 400 7th Street, S.W., Washington, D.C. 20590, HNG-31, or the procedure in the USDA-NRCS's Engineering Field Manual, Chapter 16.

Velocity

1. Maximum design velocity shall be as shown below. Except for short transition sections, flow with a channel gradient within the range of 0.7 to 1.3 of this

flow's critical slope must be avoided unless the channel is straight. Velocities exceeding critical will be restricted to straight reaches.

Design Flow Depth (ft.)	Maximum Velocity (ft./sec.)
0.0 – 0.5	25
0.5 – 1.0	15
Greater than 1.0	10

- Waterways or outlets with velocities exceeding critical shall discharge into an energy dissipater to reduce velocity to less than critical, or to a velocity the downstream soil and vegetative conditions will allow.

Cross Section

The cross section shall be triangular, parabolic, or trapezoidal. Monolithic concrete or gabions may be rectangular.

Freeboard

The minimum freeboard for lined waterways or outlets shall be 0.25 feet above design high water in areas where erosion resistant vegetation cannot be grown adjacent to the paved side slopes. No freeboard is required where good vegetation can be grown and is maintained.

Side Slope

Steepest permissible side slopes, horizontal to vertical will be as follows:

- Non-Reinforced Concrete
 - Hand-placed, formed concrete
 - Height of lining, 1.5 ft or less..... Vertical
 - Hand placed screened concrete or mortared In-place flagstone
 - Height of lining, less than 2 ft..... 1 to 1
 - Height of lining, more than 2 ft..... 2 to 1
- Slip form concrete:
 - Height of lining, less than 3 ft..... 1 to 1
- Rock Riprap..... 2 to 1
- Gabions..... Vertical
- Pre-cast Concrete Sections..... Vertical

Lining Thickness

Minimum lining thickness shall be as follows:

- Concrete.....4 in. (In most problem areas, shall be 5 in. with welded wire fabric reinforcing.)
- Rock Riprap.....1.5 x maximum stone size plus thickness of filter or bedding.
- Flagstone.....4 in. including mortar bed.

Related Structures

Side inlets, drop structures, and energy dissipaters shall meet the hydraulic and structural requirements of the site.

Filters or Bedding

Filters or bedding to prevent piping, reduce uplift pressure, and collect water will be used as required and will be designed in accordance with sound engineering principles. Weep holes and drains should be provided as needed.

Concrete

Concrete used for lining shall be so proportioned that it is plastic enough for thorough consolidation and stiff enough to stay in place on side slopes. A dense product will be required. A mix that can be certified as suitable to produce a minimum strength of at least 3,000 pounds per square inch will be required. Cement used shall be Portland Cement, Type I, II, IV, or V. Aggregate used shall have a maximum diameter of 1 1/2 inches.

Weep holes should be provided in concrete footings and retaining walls to allow free drainage of water. Pipe used for weep holes shall be non-corrosive.

Mortar

Mortar used for mortared in-place flagstone shall consist of a mix of cement, sand, and water. Follow directions on the bag of mortar for proper mixing of mortar and water.

Contraction Joints

Contraction joints in concrete linings, where required, shall be formed transversely to a depth of about one third the thickness of the lining at a uniform spacing in the range of 10 to 15 feet.

Rock Riprap or Flagstone

Stone used for riprap or gabions shall be dense and hard enough to withstand exposure to air, water, freezing, and thawing. Flagstone shall be flat for ease of placement and have the strength to resist exposure and breaking. Rock riprap maximum size shall be as follows:

Velocity, f.p.s.	dmax, inches
5.0	6
8.5	12
10	18
12	24
15	36

A complete riprap gradations is provided in Table 5B.4, page 5B.38.

Cutoff Walls

Cutoff walls shall be used at the beginning and ending of concrete lining. For rock riprap lining, cutoff walls shall be keyed into the channel bottom and at both ends of the lining.

Construction Specifications

1. The foundation area shall be cleared of trees, stumps, roots, sod, loose rock, or other objectionable material.
2. The cross-section shall be excavated to the neat lines and grades as shown on the plans. Over-excavated areas shall be backfilled with moist soil compacted to the density of the surrounding material.
3. No abrupt deviations from design grade or horizontal alignment shall be permitted.
4. Concrete linings shall be placed to the thickness shown on the plans and finished in a workmanlike manner. Adequate precautions shall be taken to

protect freshly placed concrete from extreme (hot or cold) temperatures, to ensure proper curing.

5. Filter bedding and rock riprap shall be placed to line and grade in the manner specified.
6. Construction operation shall be done in such a manner that erosion, air pollution, and water pollution will be minimized and held within legal limits. The completed job shall present a workmanlike appearance. All disturbed areas shall be vegetated or otherwise protected against soil erosion.

Maintenance

Pavement or lining should be maintained as built to prevent undermining and deterioration. Existing trees next to pavements should be removed, as roots can cause uplift damage.

Vegetation next to pavement should be maintained in good condition to prevent scouring if the pavement is overtopped. See Standard and Specifications for Permanent Critical Area Seeding on page 3.5.

Figure 5B.11
Determining “n” for Riprap Lined Channel using Depth of Flow
 (USDA - NRCS)

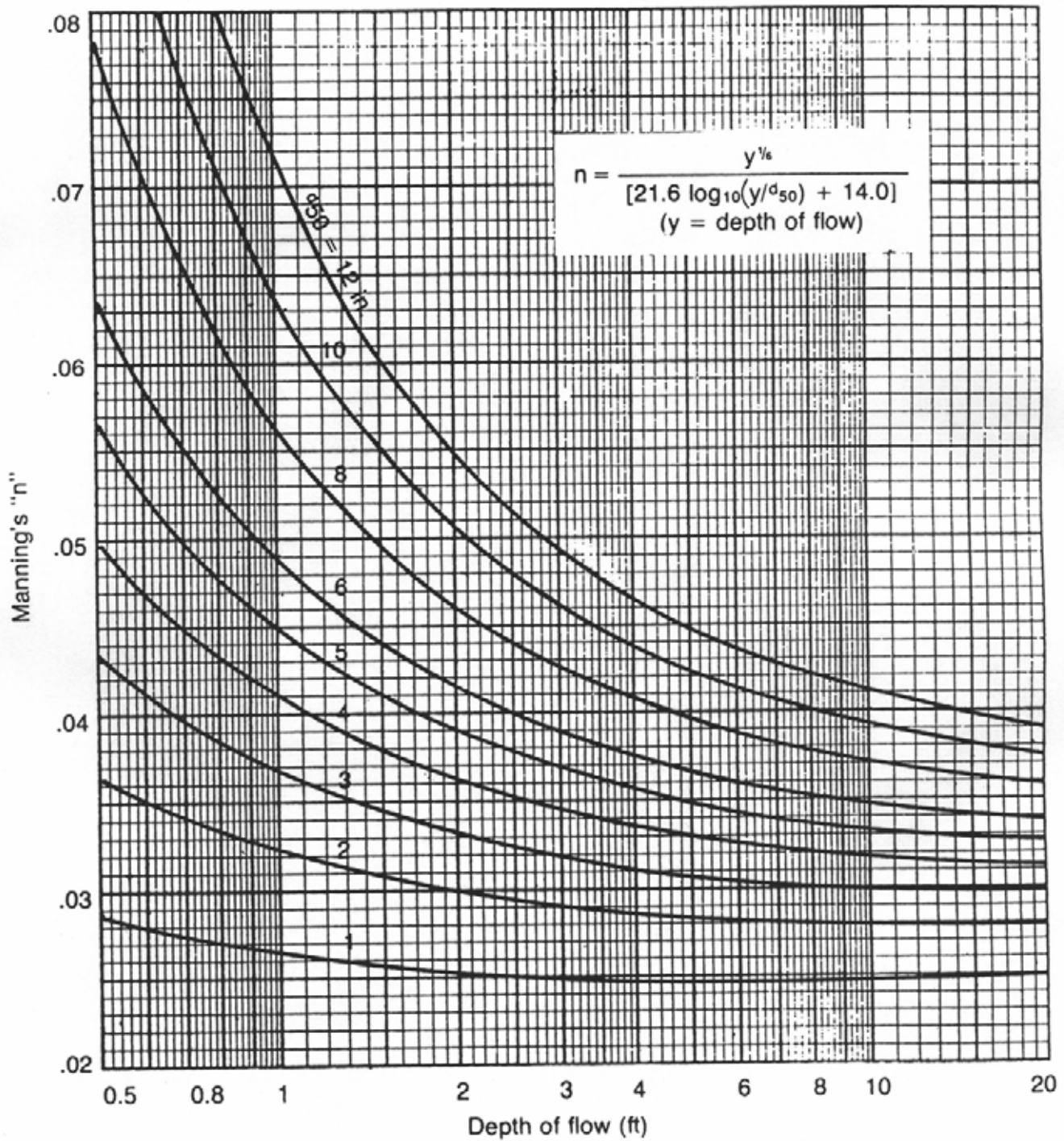

STANDARD AND SPECIFICATIONS FOR ROCK OUTLET PROTECTION



Definition

A section of rock protection placed at the outlet end of the culverts, conduits, or channels.

Purpose

The purpose of the rock outlet protection is to reduce the depth, velocity, and energy of water, such that the flow will not erode the receiving downstream reach.

Scope

This standard applies to the planning, design, and construction of rock riprap and gabions for protection of downstream areas. It does not apply to rock lining of channels or streams.

Conditions Where Practice Applies

This practice applies where discharge velocities and energies at the outlets of culverts, conduits, or channels are sufficient to erode the next downstream reach. This applies to:

1. Culvert outlets of all types.
2. Pipe conduits from all sediment basins, dry storm water ponds, and permanent type ponds.
3. New channels constructed as outlets for culverts and conduits.

Design Criteria

The design of rock outlet protection depends entirely on the location. Pipe outlet at the top of cuts or on slopes steeper than 10 percent, cannot be protected by rock aprons or riprap sections due to re-concentration of flows and high velocities encountered after the flow leaves the apron.

Many counties and state agencies have regulations and design procedures already established for dimensions, type and size of materials, and locations where outlet protection is required. Where these requirements exist, they shall be followed.

Tailwater Depth

The depth of tailwater immediately below the pipe outlet must be determined for the design capacity of the pipe. If the tailwater depth is less than half the diameter of the outlet pipe, and the receiving stream is wide enough to accept divergence of the flow, it shall be classified as a Minimum Tailwater Condition; see Figure 5B.12 on page 5B.25 as an example. If the tailwater depth is greater than half the pipe diameter and the receiving stream will continue to confine the flow, it shall be classified as a Maximum Tailwater Condition; see Figure 5B.13 on page 5B.26 as an example. Pipes which outlet onto flat areas with no defined channel may be assumed to have a Minimum Tailwater Condition; see Figure 5B.12 on page 5B.25 as an example.

Apron Size

The apron length and width shall be determined from the curves according to the tailwater conditions:

- Minimum Tailwater – Use Figure 5B.12 on page 5B.25
- Maximum Tailwater – Use Figure 5B.13 on page 5B.26

If the pipe discharges directly into a well defined channel, the apron shall extend across the channel bottom and up the channel banks to an elevation one foot above the maximum tailwater depth or to the top of the bank, whichever is less.

The upstream end of the apron, adjacent to the pipe, shall have a width two (2) times the diameter of the outlet pipe, or conform to pipe end section if used.

Bottom Grade

The outlet protection apron shall be constructed with no slope along its length. There shall be no overfall at the end of the apron. The elevation of the downstream end of the apron shall be equal to the elevation of the receiving channel or adjacent ground.

Alignment

The outlet protection apron shall be located so that there are no bends in the horizontal alignment.

Materials

The outlet protection may be done using rock riprap, grouted riprap, or gabions.

Riprap shall be composed of a well-graded mixture of stone size so that 50 percent of the pieces, by weight, shall be larger than the d_{50} size determined by using the charts. A well-graded mixture, as used herein, is defined as a mixture composed primarily of larger stone sizes, but with a sufficient mixture of other sizes to fill the smaller voids between the stones. The diameter of the largest stone size in such a mixture shall be 1.5 times the d_{50} size.

Thickness

The minimum thickness of the riprap layer shall be 1.5 times the maximum stone diameter for d_{50} of 15 inches or less; and 1.2 times the maximum stone size for d_{50} greater than 15 inches. The following chart lists some examples:

D_{50} (inches)	d_{max} (inches)	Minimum Blanket Thickness (inches)
4	6	9
6	9	14
9	14	20
12	18	27
15	22	32
18	27	32
21	32	38
24	36	43

Stone Quality

Stone for riprap shall consist of field stone or rough unhewn quarry stone. The stone shall be hard and angular and of a quality that will not disintegrate on exposure to water or weathering. The specific gravity of the individual stones shall be at least 2.5.

Recycled concrete equivalent may be used provided it has a

density of at least 150 pounds per cubic foot, and does not have any exposed steel or reinforcing bars.

Filter

A filter is a layer of material placed between the riprap and the underlying soil surface to prevent soil movement into and through the riprap. Riprap shall have a filter placed under it in all cases.

A filter can be of two general forms: a gravel layer or a plastic filter cloth. The plastic filter cloth can be woven or non-woven monofilament yarns, and shall meet these base requirements: thickness 20-60 mils, grab strength 90-120 lbs; and shall conform to ASTM D-1777 and ASTM D-1682.

Gravel filter blanket, when used, shall be designed by comparing particle sizes of the overlying material and the base material. Design criteria are available in Standard and Specification for Riprap Slope Protection on page 5B.57.

Gabions

Gabions shall be made of hexagonal triple twist mesh with heavily galvanized steel wire. The maximum linear dimension of the mesh opening shall not exceed 4 ½ inches and the area of the mesh opening shall not exceed 10 square inches.

Gabions shall be fabricated in such a manner that the sides, ends, and lid can be assembled at the construction site into a rectangular basket of the specified sizes. Gabions shall be of single unit construction and shall be installed according to manufacturers recommendations.

The area on which the gabion is to be installed shall be graded as shown on the drawings. Foundation conditions shall be the same as for placing rock riprap, and filter cloth shall be placed under all gabions. Where necessary, key, or tie, the structure into the bank to prevent undermining of the main gabion structure.

Maintenance

Once a riprap outlet has been installed, the maintenance needs are very low. It should be inspected after high flows for evidence of scour beneath the riprap or for dislodged stones. Repairs should be made immediately.

Design Procedure

1. Investigate the downstream channel to assure that nonerosive velocities can be maintained.
2. Determine the tailwater condition at the outlet to establish which curve to use.
3. Enter the appropriate chart with the design discharge to

determine the riprap size and apron length required. It is noted that references to pipe diameters in the charts are based on full flow. For other than full pipe flow, the parameters of depth of flow and velocity must be used to adjust the design discharges.

- Calculate apron width at the downstream end if a flare section is to be employed.

Examples

Example 1: Pipe Flow (full) with discharge to unconfined section.

Given: A circular conduit flowing full.

$Q = 280$ cfs, diam. = 66 in., tailwater (surface) is 2 ft. above pipe invert (minimum tailwater condition).

Find: Read $d_{50} = 1.2$ and apron length (L_a) = 38 ft.

Apron width = diam. + $L_a = 5.5 + 38 = 43.5$ ft.

Use: $d_{50} = 15''$, $d_{max} = 22''$, blanket thickness = 32''

Example 2: Box Flow (partial) with high tailwater

Given: A box conduit discharging under partial flow conditions. A concrete box 5.5 ft. x 10 ft. flowing 5.0 ft. deep,

$Q = 600$ cfs and tailwater surface is 5 ft. above invert (max. tailwater condition).

Since this is not full pipe and does not directly fit the nomograph assumptions of Figure 7B.13 substitute depth as the diameter, to find a discharge equal to full pipe flow for that diameter, in this case 60 inches.

Since, $Q = AV$ and $A = \frac{\pi D^2}{4}$

First, compute velocity:

$V = (Q/A) = (600/(5) (10)) = 12$ fps

Then substituting:

$$Q = \frac{\pi D^2}{4} \times V = \frac{3.14 (5 \text{ ft})^2}{4} \times 12 \text{ fps} = 236 \text{ cfs}$$

At the intersection of the curve $d = 60$ in. and $Q = 236$ cfs, read $d_{50} = 0.4$ ft.

Then reading the $d = 60$ in. curve, read apron length (L_a) = 40 ft.

Apron width, $W = \text{conduit width} + (6.4)(L_a) = 10 + (0.4)(40) = 26$ ft.

Example 3: Open Channel Flow with Discharge to Unconfined Section

Given: A trapezoidal concrete channel 5 ft. wide with 2:1 side slopes is flowing 2 ft. deep, $Q = 180$ cfs (velocity = 10 fps) and the tailwater surface downstream is 0.8 ft. (minimum tailwater condition).

Find: Using similar principles as Example 2, compute equivalent discharge for a 2 foot, using depth as a diameter, circular pipe flowing full at 10 feet per second.

Velocity:

$$Q = \frac{\pi (2 \text{ ft})^2}{4} \times 10 \text{ fps} = 31.4 \text{ cfs}$$

At intersection of the curve, $d = 24$ in. and $Q = 32$ cfs, read $d_{50} = 0.6$ ft.

Then reading the $d = 24$ in. curve, read apron length (L_a) = 20 ft.

Apron width, $W = \text{bottom width of channel} + L_a = 5 + 20 = 25$ ft.

Example 4: Pipe flow (partial) with discharge to a confined section

Given: A 48 in. pipe is discharging with a depth of 3 ft. $Q = 100$ cfs, and discharge velocity of 10 fps (established from partial flow analysis) to a confined trapezoidal channel with a 2 ft. bottom, 2:1 side slopes, $n = .04$, and grade of 0.6%.

Calculation of the downstream channel (by Manning's Equation) indicates a normal depth of 3.1 ft. and normal velocity of 3.9 fps.

Since the receiving channel is confined, the maximum tailwater condition controls.

Find: discharge using previous principles:

$$Q = \frac{\pi (3 \text{ ft})^2}{4} \times 10 \text{ fps} = 71 \text{ cfs}$$

At the intersection of $d = 36$ in. and $Q = 71$ cfs, read $d_{50} = 0.3$ ft.

Reading the $d = 36''$ curve, read apron length (L_a) = 30 ft.

Since the maximum flow depth in this reach is 3.1 ft., that is the minimum depth of riprap to be maintained for the entire length.

Construction Specifications

1. The subgrade for the filter, riprap, or gabion shall be prepared to the required lines and grades. Any fill required in the subgrade shall be compacted to a density of approximately that of the surrounding undisturbed material.
2. The rock or gravel shall conform to the specified grading limits when installed respectively in the riprap or filter.
3. Filter cloth shall be protected from punching, cutting, or tearing. Any damage other than an occasional small hole shall be repaired by placing another piece of cloth over the damaged part or by completely replacing the cloth. All overlaps, whether for repairs or for joining two pieces of cloth shall be a minimum of one foot.
4. Stone for the riprap or gabion outlets may be placed by equipment. Both shall each be constructed to the full course thickness in one operation and in such a manner as to avoid displacement of underlying materials. The stone for riprap or gabion outlets shall be delivered and placed in a manner that will ensure that it is reasonably homogenous with the smaller stones and spalls filling the voids between the larger stones. Riprap shall be placed in a manner to prevent damage to the filter blanket or filter cloth. Hand placement will be required to the extent necessary to prevent damage to the permanent works.

Figure 5B.12
Outlet Protection Design—Minimum Tailwater Condition
(Design of Outlet Protection from a Round Pipe Flowing Full,
Minimum Tailwater Condition: $T_w < 0.5D_o$) (USDA - NRCS)

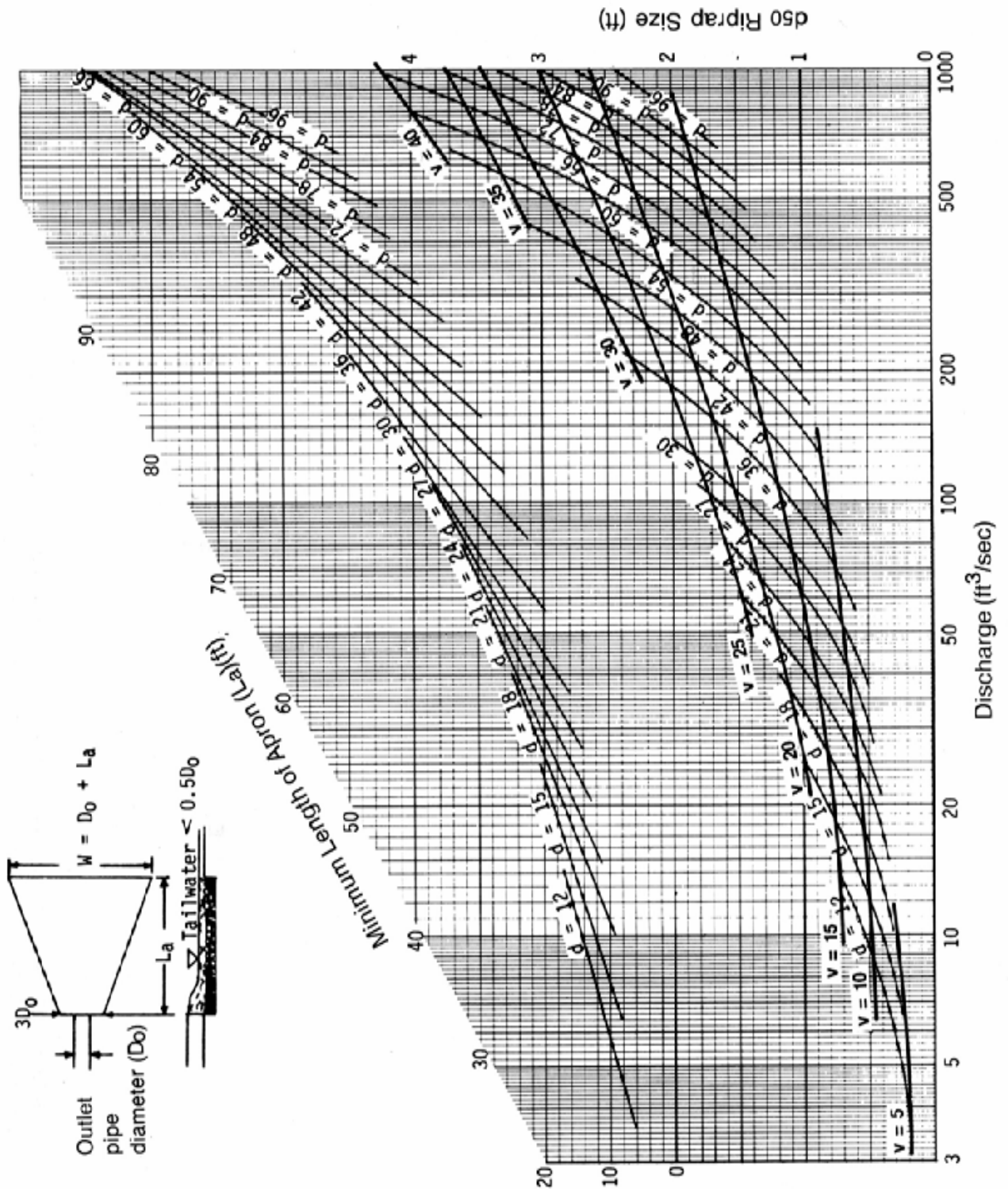
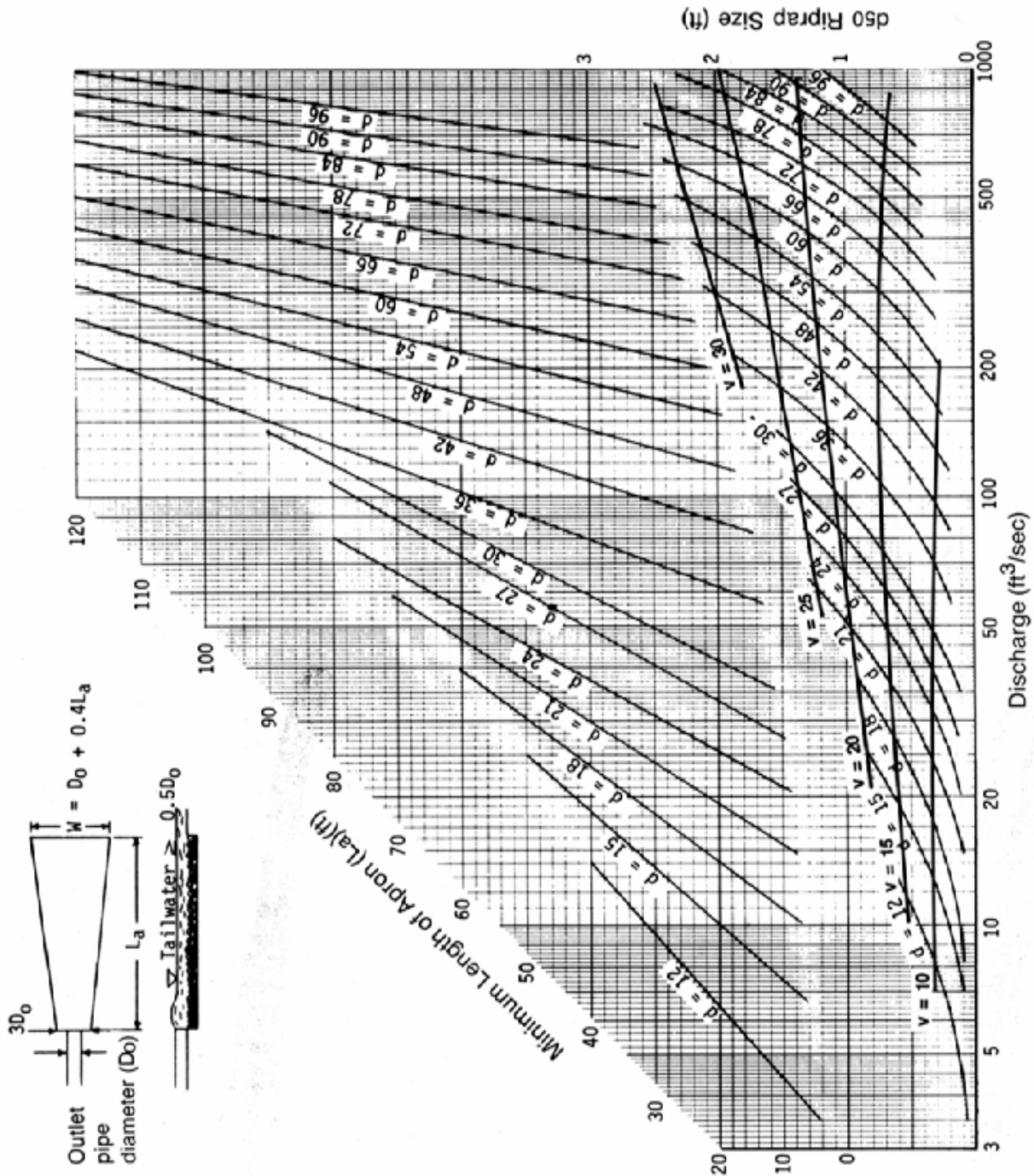

Figure 5B.13
Outlet Protection Design—Maximum Tailwater Condition
(Design of Outlet Protection from a Round Pipe Flowing Full,
Maximum Tailwater Condition: $T_w \geq 0.5D_o$) (USDA - NRCS)



**Figure 5B.14
Riprap Outlet Protection Detail (1)**

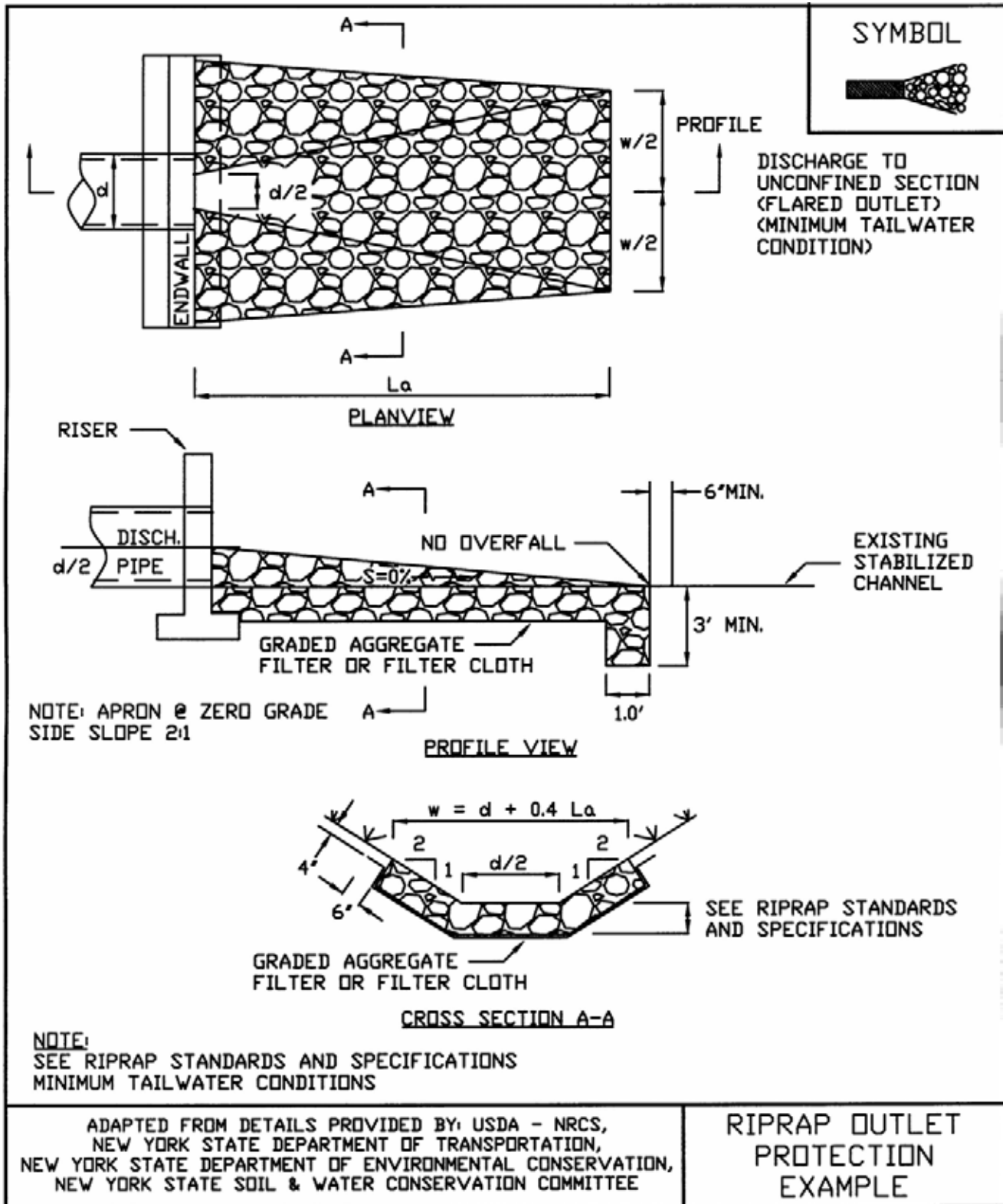
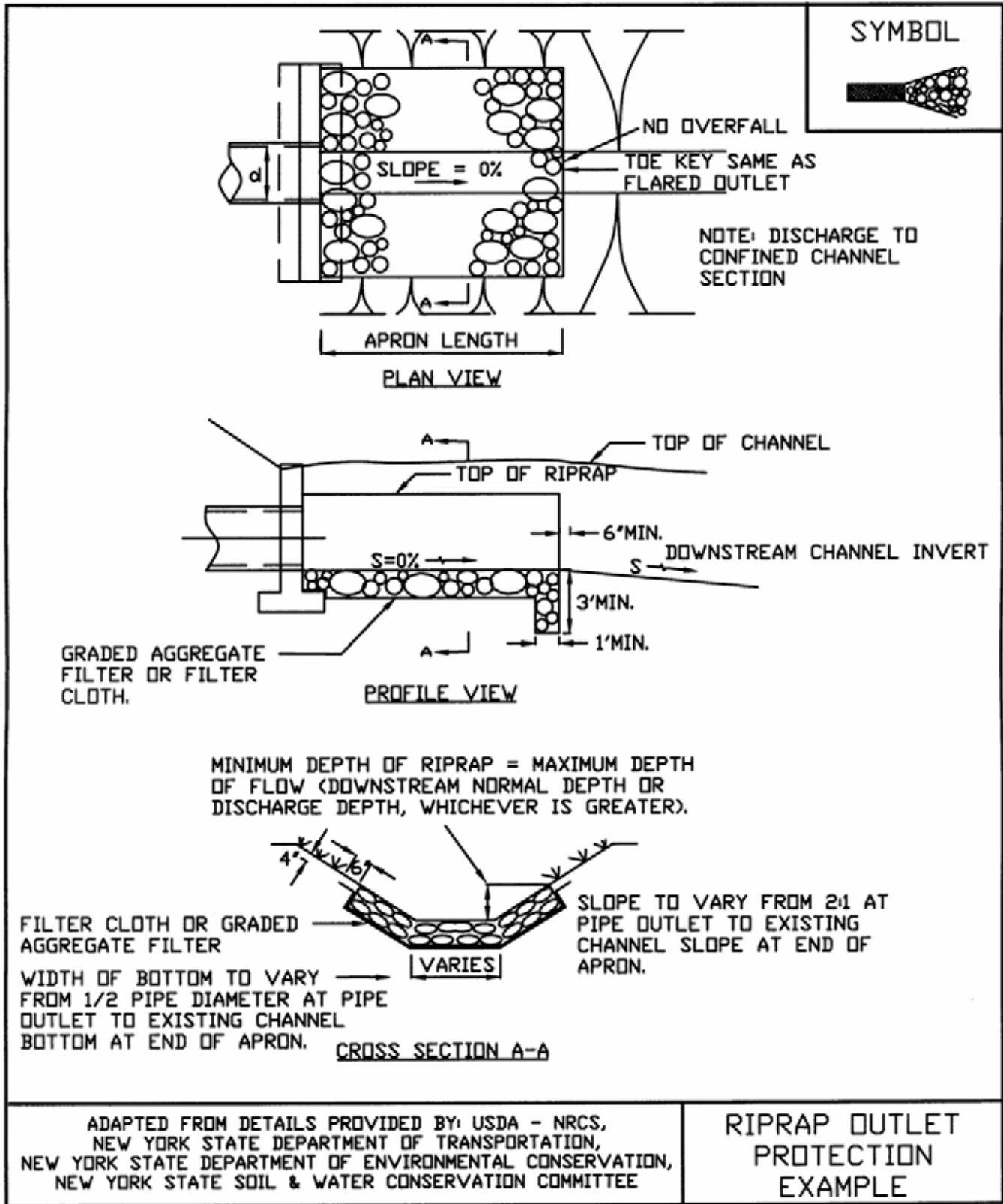
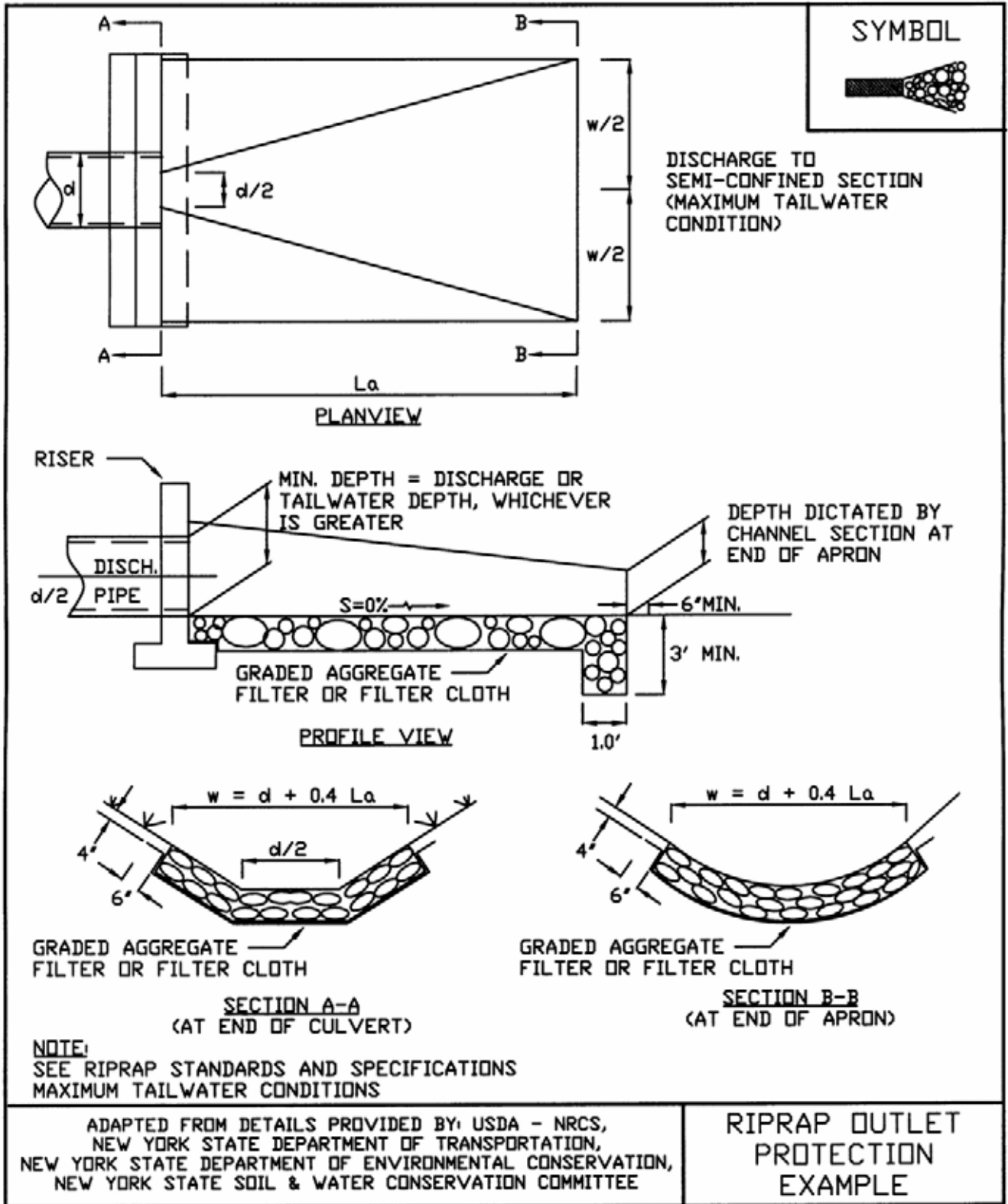

Figure 5B.15
Riprap Outlet Protection Detail (2)



**Figure 5B.16
Riprap Outlet Protection Detail (3)**



STANDARD AND SPECIFICATIONS FOR GRADE STABILIZATION STRUCTURE



Definition

A structure to stabilize the grade or to control head cutting in natural or artificial channels.

Scope

This standard applies to all types of grade stabilization structures. It does not apply to storm sewers or their component parts.

Purpose

Grade stabilization structures are used to reduce or prevent excessive erosion by reduction of velocities and grade in the watercourse or by providing channel linings or structures that can withstand the higher velocities.

Conditions Where Practice Applies

This practice applies to sites where the capability of earth and vegetative measures is exceeded in the safe handling of water at permissible velocities, where excessive grades or overfall conditions are encountered, or where water is to be lowered structurally from one elevation to another. These structures should generally be planned and installed along with, or as a part of, other conservation practices in an overall surface water disposal system.

Design Criteria

Compliance with Laws and Regulations

Design and construction shall be in compliance with state and local laws and regulations. Such compliance is the

responsibility of the landowner or developer.

General

Designs and specifications shall be prepared for each structure on an individual job basis depending on its purpose, site conditions, and the basic criteria of the conservation practice with which the structure is planned. Typical structures are as follows:

1. Channel linings of concrete, asphalt, half round metal pipe or other suitable lining materials. These linings should generally be used where channel velocities exceed safe velocities for vegetated channels due to increased grade or a change in channel cross section or where durability of vegetative lining is adversely affected by seasonal changes. Adequate protection will be provided to prevent erosion or scour of both ends of the channel lining.
2. Overfall structures of concrete, metal, rock riprap, or other suitable material is used to lower water from one elevation to another. These structures are applicable where it is desirable to drop the watercourse elevation over a very short horizontal distance. Adequate protection will be provided to prevent erosion or scour upstream, downstream and along sides of overfall structures. Structures should be located on straight sections of channel with a minimum of 100 feet of straight channel each way.
3. Pipe drops of metal pipe with suitable inlet and outlet structures. The inlet structure may consist of a vertical section of pipe or similar material, an embankment, or a combination of both. The outlet structure will provide adequate protection against erosion or scour at the pipe outlet.

Capacity

Structures that are designed to operate in conjunction with other erosion control practices shall have, as a minimum, capacity equal to the bankfull capacity of the channel delivering water to the structures. The minimum design capacity for structures that are not designed to perform in conjunction with other practices shall be that required to handle the peak rate of flow from a 10-year, 24-hour frequency storm or bankfull, whichever is greater. Peak rates of runoff used in determining the capacity requirements shall be determined by TR-55, Urban

Hydrology for Small Watersheds, or other appropriate method.

Set the rest of the structure at an elevation that will stabilize the grade of the upstream channel. The outlet should be set at an elevation to assure stability. Outlet velocities should be kept within the allowable limits for the receiving stream. Structural drop spillways need to include a foundation drainage system to reduce hydrostatic loads.

Structures which involve the retarding of floodwater or the impoundment of water shall be designed using the criteria set forth in the guidelines for Ponds or Floodwater Retarding Structures, whichever is applicable.

Construction Specifications

Structures shall be installed according to lines and grades shown on the plan. The foundation for structures shall be cleared of all undesirable materials prior to the installation of the structure. Materials used in construction shall be in conformance with the design frequency and life expectancy of the practice. Earth fill, when used as a part of the structure, shall be placed in 4-inch lifts and hand compacted within 2 feet of the structure.

Seeding, fertilizing, and mulching shall conform to the recommendation specification in Section 3.

Construction operations shall be carried out in such a manner that erosion and air and water pollution will be minimized. State and local laws concerning pollution abatement shall be complied with at every site.

Locate emergency bypass areas so that floods in excess of structural capacity enter the channel far enough downstream so as not to cause damage to the structure.

Maintenance

Once properly installed, the maintenance for the grade stabilization structure should be minimal. Inspect the structure periodically and after major storm events. Check fill for piping or extreme settlement. Ensure a good vegetative cover. Check the channel for scour or debris and loss of rock from aprons. Repair or replace failing structures immediately.

STANDARD AND SPECIFICATIONS FOR PAVED FLUME



Definition

A small concrete-lined channel to convey water on a relatively steep slope.

Purpose

To convey concentrated runoff safely down the face of a cut or fill slope without causing erosion.

Condition Where Practice Applies

Where concentrated storm runoff must be conveyed down a cut or fill slope as part of a permanent erosion control system. Paved flumes serve as stable outlets for diversions, drainage channels, or natural drainageways, that are located above relatively steep slopes. Paved flumes should be used on slopes of 1.5 to 1 or flatter.

Design Criteria

Capacity – Minimum capacity should be the 10-year frequency storm. Freeboard or enough bypass capacity should be provided to safeguard the structure from peak flows expected for the life of the structure.

Slope – The slope should not be steeper than 1.5:1 (67%).

Cutoff Walls – Install cutoff walls at the beginning and end of paved flumes. The cutoff should extend a minimum of 18 inches into the soil and across the full width of the flume and be 6 inches thick. Cutoff walls should be reinforced with #3 reinforcing bars (3/8") placed on a 6-inch grid in the center of the wall.

Anchor Lugs – Space anchor lugs a minimum of 10 feet on centers for the length of the flume. They will extend the width of the flume, extend 1 foot into subsoil, be a minimum of 6 inches thick, and be reinforced with #3 reinforcing bars placed on a 6-inch grid.

Concrete – Minimum strength of design mix shall be 3000 psi. Concrete thickness shall be a minimum of 6 inches reinforced with #3 reinforcing bars. Mix shall be dense, durable, stiff enough to stay in place on steep slopes, and sufficiently plastic for consolidation. Concrete mix should include an air-entraining admixture to resist freeze-thaw cycles.

Cross Section – Flumes shall have minimum depth of 1 foot with 1.5:1 side slopes. Bottom widths shall be based on maximum flow capacity. Chutes will be maintained in a straight alignment because of supercritical flow velocities.

Drainage filters – Use a drainage filter with all paved flumes to prevent piping and reduce uplift pressures. Size of the filter material will be dependent on the soil material the flume is located in.

Inlet Section – Design the inlet to the following minimum dimensions: side walls 2 feet high, length 6 feet, width equal to the flume channel bottom, and side slopes the same as the flume channel side slopes.

Outlet Section – Outlets must be protected from erosion. Usually an energy dissipater is used to reduce the high chute velocities to lower non-erosive velocities. Rock riprap should be placed at the end of the dissipater to spread flow evenly to the receiving channel.

See Figure 5B.17 on page 5B.35 for examples of outlet structures.

Invert – Precast concrete sections may be used in lieu of cast in place concrete. The sections should be designed at the joint to be overlapped to prevent displacement between sections. Joint sealing compound should be used to prevent migration of soil through a joint. Cutoff walls and anchor lugs should be cast in the appropriate sections to accommodate the design criteria.

Small Flumes – Where the drainage area is 10 acres or less, the design dimensions for concrete flumes may be selected from those shown in the table on the following page:

	Drainage Area (Acres)	
	<u>5</u>	<u>10</u>
Min Bottom Width	4	8
Min Inlet Depth (ft)	2	2
Min Channel Depth (ft)	1.3	1.3
Max Channel Slope	1.5:1	1.5:1
Max Side Slope	1.5:1	1.5:1

See **Figure 5B.18 on page 5B.36** for details.

Construction Specifications

1. The subgrade shall be constructed to the lines and grades shown on the plans. Remove all unsuitable material and replace them if necessary with compacted stable fill materials. Shape subgrade to uniform surface. Where concrete is poured directly on subsoil, maintain it in a moist condition.
2. On fill slopes, the soil adjacent to the chute, for a minimum of 5 feet, must be well compacted.

3. Where drainage filters are placed under the structure, the concrete will not be poured on the filter. A plastic liner, a minimum of 4 mils thick, will be placed to prevent contamination of filter layer.

4. Place concrete for the flume to the thickness shown on the plans and finish according to details. Protect freshly poured concrete from extreme temperatures (hot or cold) and ensure proper curing.

5. Form, reinforce, and pour together cutoff walls, anchor lugs and channel linings. Provide traverse joints to control cracking at 20-foot intervals. Joints can be formed by using a 1/8 inch thick removable template or by sawing to a minimum depth of 1 inch. Flumes longer than 50 feet shall have preformed expansion joints installed.

6. Immediately after construction, all disturbed areas will be final graded and seeded.

Maintenance

Inspect flumes after each rainfall until all areas adjoining the flume are permanently stabilized. Repair all damage immediately. Inspect outlet and rock riprap to assure presence and stability. Any missing components should be immediately replaced.

Figure 5B.17
Examples of Outlet Structures

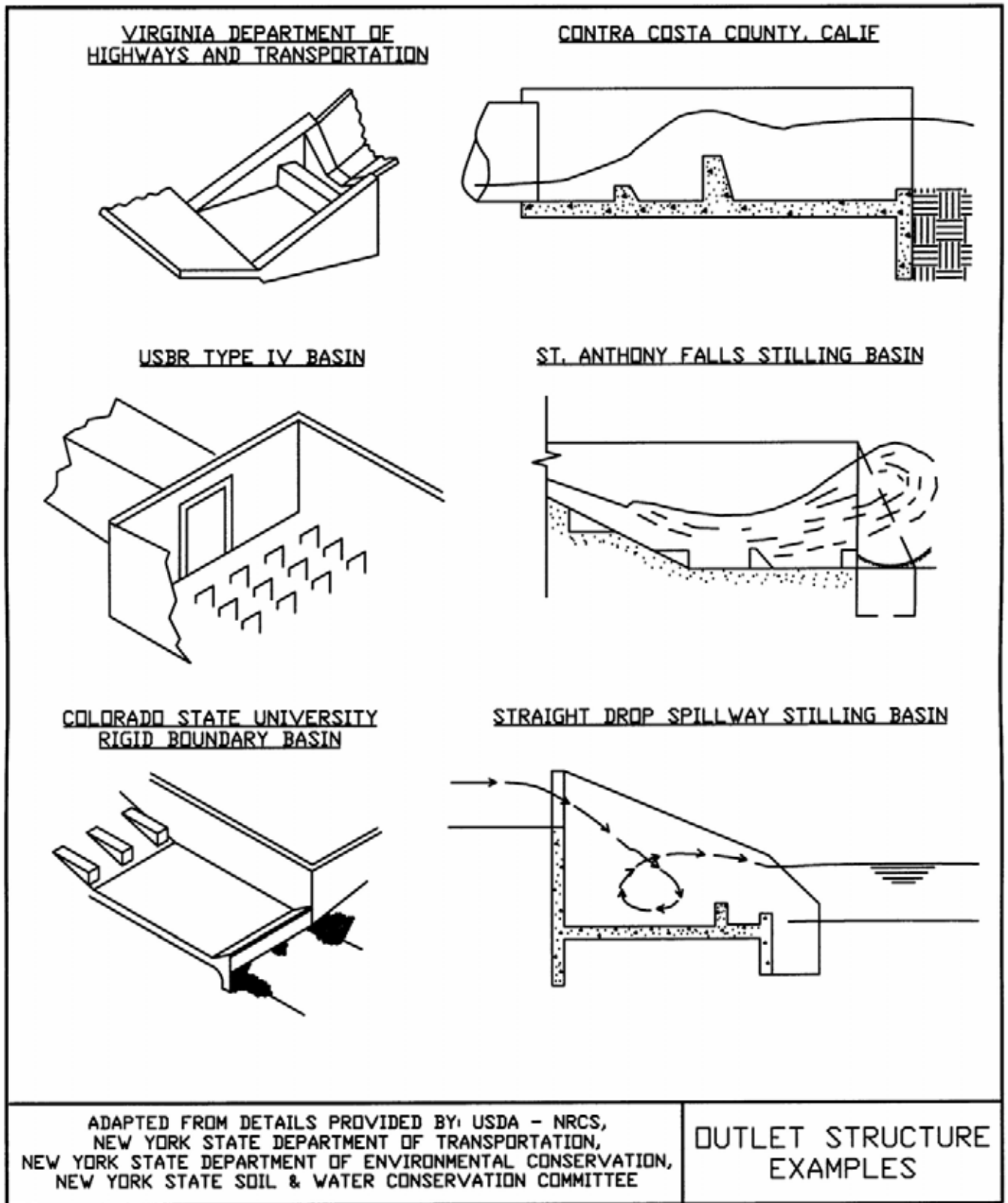

**Figure 5B.18
Paved Flume**

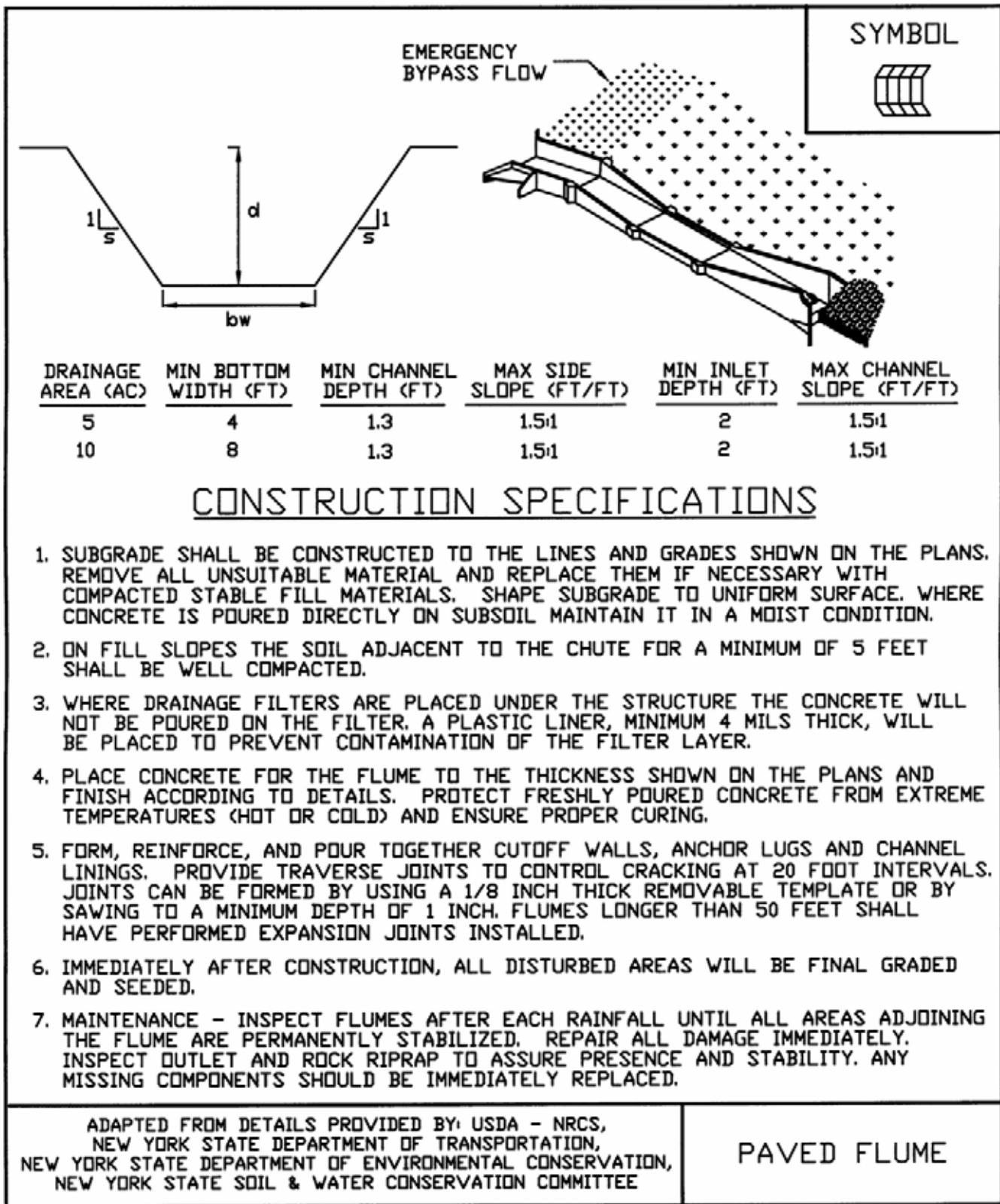

STANDARD AND SPECIFICATIONS FOR STRUCTURAL STREAMBANK PROTECTION



- Streambank protection should begin at a stable location and end at a stable point along the bank.
- Changes in alignment should not be done without a complete analysis of effects on the rest of the stream system for both environmental and stability effects.
- Provisions should be made to maintain and improve fish and wildlife habitat. For example, restoring lost vegetation will provide valuable shade, food, and/or cover.
- Ensure that all requirements of state law and all permit requirements of local, state, and federal agencies are met.

Definition

Stabilization of eroding streambanks by the use of designed structural measures, such as rock riprap, gabions, pre-cast concrete wall units and grid pavers.

Purpose

To protect exposed or eroded streambanks from the erosive forces of flowing water.

Condition Where Practice Applies

Generally applicable where flow velocities exceed 6 feet per second or where vegetative streambank protection is inappropriate. Necessary where excessive flows have created an erosive condition on a streambank.

Design Criteria

- Since each channel is unique, measures for structural streambank should be installed according to a design based on specific site conditions.
- Develop designs according to the following principles:
- Make protective measures compatible with other channel modifications planned or being carried out in the channel reaches.
- Use the design velocity of the peak discharge of the 10-year storm or bankfull discharge, whichever is less. Structural measures should be capable of withstanding greater flows without serious damage.
- Ensure that the channel bottom is stable or stabilized by structural means before installing any permanent bank protection.

Construction Specifications

Riprap – Riprap is the most commonly used material to structurally stabilize a streambank. While riprap will provide the structural stabilization necessary, the bank can be enhanced with vegetative material to slow the velocity of water, filter debris, and enhance habitat. See Biotechnical Measures for Erosion and Sediment Control, Section 4, for more information.

1. Bank slope – slopes shall be graded to 2:1 or flatter prior to placing bedding, filter fabric, or riprap.
2. Filter – filters should be placed between the base bank material and the riprap and meet the requirements of criteria listed in the Standards and Specifications for Riprap Slope Protection, page 5B.57.
3. Gradation – The gradation of the riprap is dependent on the velocity expected against the bank for the design conditions. See Table 5B.3 on page 5B.38. Once the velocity is known, gradation can be selected from the gradations below. The riprap should extend 2 feet below the channel bottom and be keyed into the bank both at the upstream end and downstream end of the proposed work or reach.

See Figure 5B.19 on page 5B.39 for details.

Gabions – Design and install gabions according to manufacturers recommendations. Since these are rectangular, rock-filled wire baskets, they are somewhat flexible in armoring channel bottoms and banks. They can withstand significantly higher velocities for the size stone they contain due to the basket structure. They also stack vertically to act as a retaining wall for constrained areas. (Figure 5B.20).

Gabions should not be used in streams that carry a bedload that can abrade the wire causing separation and failure.

Reinforced Concrete - May be used to armor eroding sections of streambank by constructing walls, bulk heads, or bank linings. Provide positive drainage behind these structures to relieve uplift pressures.

Grid Pavers – Modular concrete units with or without void areas can be used to stabilize streambanks. Units with void areas can allow the establishment of vegetation. These structures may be obtained in a variety of shapes (Figure 5B.20) or they may be formed and poured in place. Maintain design and installation in accordance with manufacturers instructions.

Revetment – Structural support or armoring to protect an embankment from erosion. Riprap and gabions are commonly used. Also used is a hollow fabric mattress with cells that receive a concrete mixture, (ie. Fabriform). Any revetment should be installed to a depth below the

anticipated channel degradation and into the channel bed as necessary to provide stability.

Modular Pre-Cast Units – Interlocking modular precast units of different sizes, shapes, heights, and depths, have been developed for a wide variety of applications. These units serve in the same manner as gabions. They provide vertical support in tight areas as well as durability. Many types are available with textured surfaces. They also act as gravity retaining walls. They should be designed and installed in accordance with the manufacturers recommendations (Figure 5B.20).

All areas disturbed by construction should be stabilized as soon as the structural measures are complete.

Maintenance

Check stabilized streambank sections after every high-water event, and make any needed repairs immediately to prevent any further damage or unraveling of the existing work.

Table 5B.3—Riprap Gradations

Class	Layer Thickness (in.)	Max Velocity (ft./s.)	Wave Height (ft.)	PERCENT FINER BY WEIGHT											
				D ₁₀			D ₅₀			D ₈₅			D ₁₀₀		
				Wt. (lbs.)	d _o (in.)	d _□ (in.)	Wt. (lbs.)	d _o (in.)	d _□ (in.)	Wt. (lbs.)	d _o (in.)	d _□ (in.)	Wt. (lbs.)	d _o (in.)	d _□ (in.)
I	18	8.5	-	5	5	4	50	10	8	100	13	10	150	15	12
II	18	10	-	17	7	6	170	15	12	340	19	15	500	22	18
III	24	12	2	46	10	8	460	21	17	920	26	21	1400	30	24
IV	36	14	3	150	15	12	1500	30	25	3000	39	32	4500	47	36
V	48	17	4.8	370	20	16	3700	42	34	7400	53	43	11,000	60	49

d_o = gravel material d_□ = angular rock riprap
 Wt = weight in pounds

**Figure 5B.19
Riprap Streambank Protection**

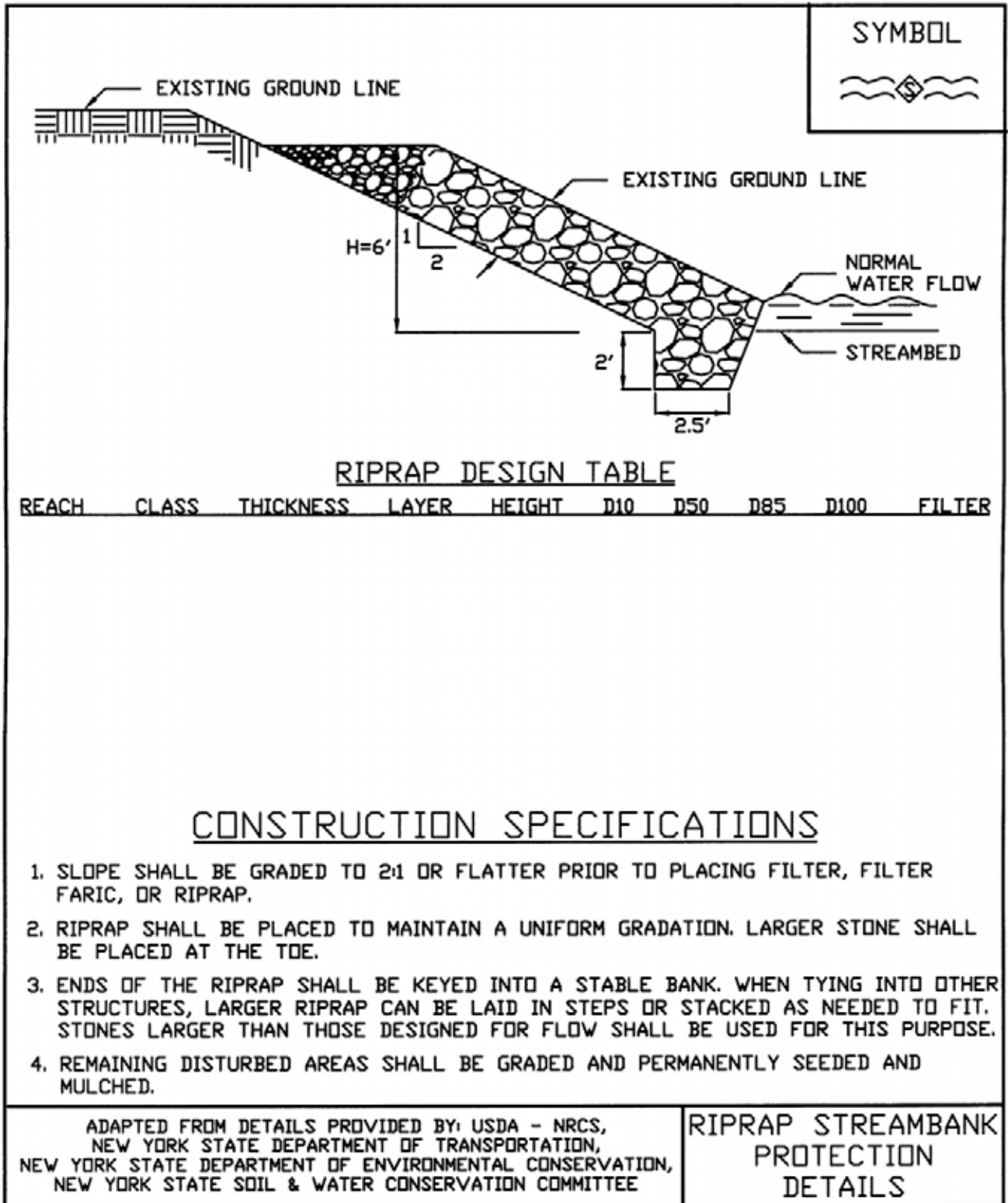
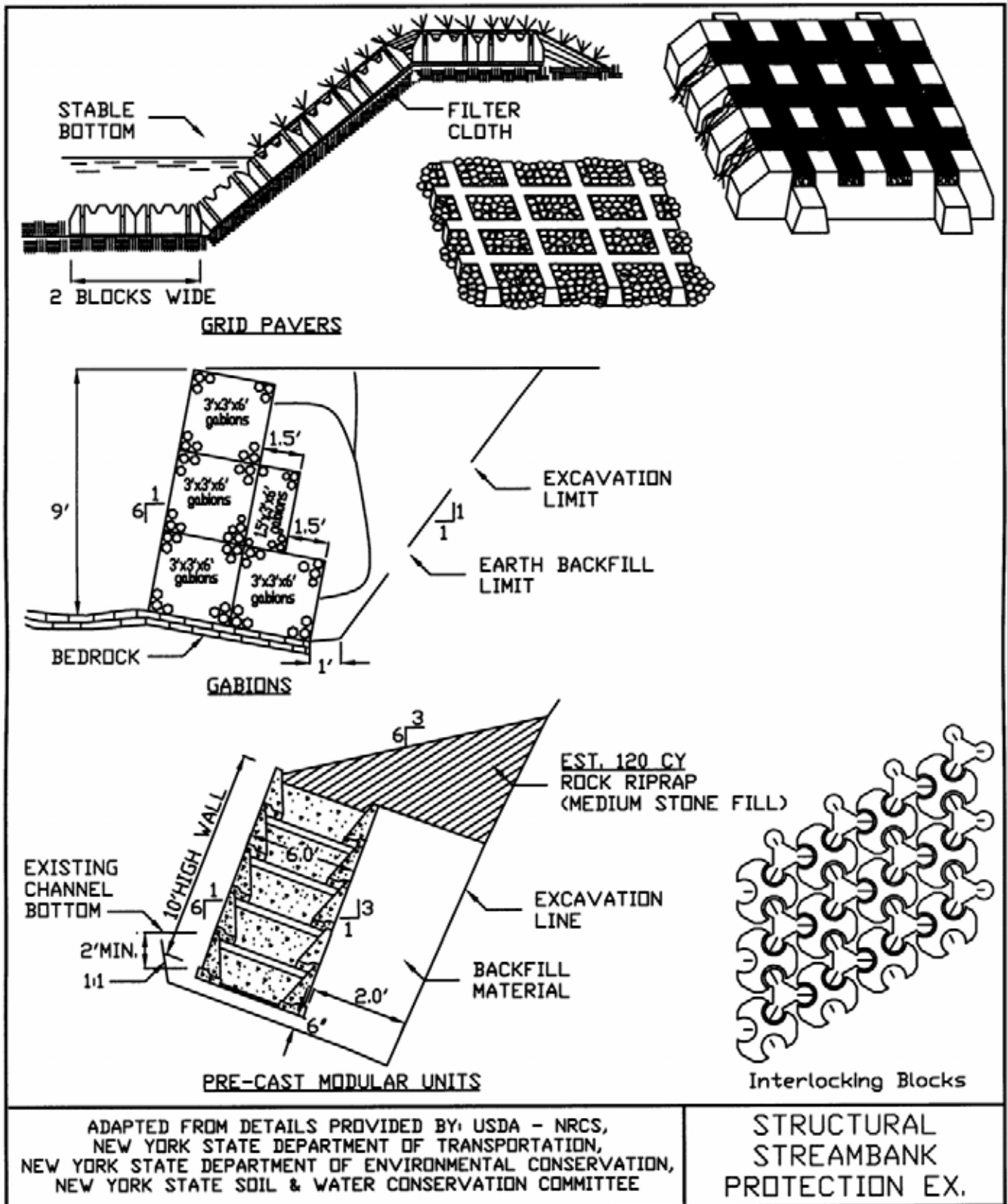

Figure 5B.20
Structural Streambank Protection Methods



STANDARD AND SPECIFICATIONS FOR DEBRIS BASIN



Definition

A barrier or dam constructed across a waterway or at other suitable locations to form a basin for catching and storing sediment and other waterborne debris.

Scope

This standard covers the installation of debris basins on sites where: (1) failure of the structure would not result in loss of life or interruption of use or service of public utilities; (2) the drainage area does not exceed 200 acres; and (3) the water surface area at the crest of the auxiliary spillway does not exceed 5 acres. For this purpose of this standard, debris basins are classified according to the following table:

Class	Maximum Drainage Area (Ac)	Maximum Height ¹ of Dam (ft)	Auxiliary Spillway Required	Design Storm Frequency
1 ²	20	5	No	—
2	20	10	Yes	50 yrs.
3	200	20	Yes	100 yrs.

¹ Height is measured from the low point of original ground at the downstream toe to the top of dam.

² Class 1 basins are to be used only where site conditions are such that it is impractical to construct an auxiliary spillway in undisturbed ground.

Purpose

To provide a permanent or temporary means of trapping and storing sediment from eroding areas in order to protect properties or stream channels below the installation from damage by excessive sedimentation and debris.

Conditions Where Practice Applies

Where physical conditions or land ownership preclude the treatment of the sediment source by the installation of erosion control measures to reduce runoff and erosion. It may also be used as a permanent or temporary measure during grading and development of areas above. If a debris basin is used as a temporary structure, it may be removed once the development is complete and the area is permanently protected against erosion by vegetative or mechanical means.

Design Criteria

The capacity of the debris basin to the elevation of the crest of the service spillway is to equal the volume of the expected sediment yield from the unprotected portions of the drainage area during the planned useful life of the structure. The minimum volume of sediment in acre feet per year can be determined for various drainage areas under construction from curves on Figure 5B.21 on page 5B.44.

NOTE: All Debris Basins will be designed and constructed in accordance with the New York State Department of Environmental Conservation Dam Safety Section, "Guidelines for Design of Dams," and all applicable permits must be obtained.

Spillway Design

Runoff will be computed by the USDA-NRCS, TR-55, or other appropriate method. Runoff computations should be based upon the soil cover conditions expected to prevail during the construction period of the development.

For Class 2 basins, the combined capacities of the service and auxiliary spillways will be sufficient to pass the peak rate of runoff from a 50-year frequency storm after adjusting for flood routing.

For Class 3 basins, the combined capacities of the service and auxiliary spillways will be sufficient to pass the peak rate of runoff from a 100-year frequency storm.

Pipe Spillway

The pipe spillway will consist of a vertical pipe box type riser jointed to a conduit, which will extend through the embankment and outlet beyond the downstream toe of the fill. The minimum diameter of the conduit will be 8 inches.

The service spillway system will be perforated to provide for a gradual drawdown after each storm event. The minimum average capacity of the service spillway will be sufficient to discharge 5 inches of runoff from the drainage area in 24 hours (0.21 cfs per acre of drainage area). The riser of the service spillway shall be a cross-sectional area at least 1.3 times that of the barrel.

1. **Crest Elevation:** The crest elevation of the riser shall be at least 3 feet below the crest elevation of the embankment.
2. **Perforated:** Metal pipe risers shall be perforated with 1-1/2 inch diameter holes spaced 8 inches vertically and 10-12 inches horizontally around the pipe. Box type risers shall be ported or have some means for complete drainage of the sediment pool within a 5 day period following storm inflows.
3. **Anti-vortex device:** An anti-vortex device shall be installed on the top of the riser.
4. **Base:** The riser shall have a base attached with a watertight connection. The base shall have sufficient weight to prevent flotation of the riser.
5. **Trash rack:** An approved trash rack shall be firmly attached to the top of the riser if the pipe spillway conveys 25 percent or more of the peak rate of runoff from the design storm.
6. **Anti-seepage measures:** Anti-seep collars, or seepage diaphragms, shall be installed around the pipe conduit within the normal saturation zone when any of the following conditions exist:
 - A. The settled height of dam exceeds 15 ft.
 - B. The conduit is of smooth pipe 8 inches, or larger, in diameter.
 - C. The conduit is of corrugated metal pipe 12 inches in diameter, or larger.
The anti-seep collars and their connections to the pipe shall be watertight. The maximum spacing shall be approximately 14 times the minimum projection of the collar measured perpendicular to the pipe. In lieu of anti-seep collars, a seepage diaphragm can be used whose projections are three times the diameter of the pipe in all directions.

7. **Outlet protection:** Protection against scour at the discharge end of the pipe spillway shall be provided. Protective measures may include structures of the impact basin type, rock riprap, paving, revetment, excavation of plunge pool or use of other approved methods.

Auxiliary Spillway

Class 2 and 3 basins: An auxiliary spillway shall be excavated in undisturbed ground whenever site conditions permit. The auxiliary spillway cross section shall be trapezoidal with a minimum bottom width of 8 feet.

Class 1 basins: The embankment may be used as an auxiliary spillway. In these cases, the downstream slope of the embankment shall be 5:1 or flatter and the embankment must be immediately protected against erosion by means such as sodding, rock riprap, asphalt coating, or other approved methods.

1. **Capacity:** The minimum capacity of the auxiliary spillway shall be that required to pass the peak rate of runoff from the design storm, less any reduction due to flow in the pipe spillway.
2. **Velocities:** The maximum allowable velocity of flow in the exit channel shall be 6 feet per second for vegetated channels. For channels with erosion protection other than vegetation, velocities shall be in the safe range for the type of protection used.
3. **Erosion protection:** Provide for erosion protection by vegetation or by other suitable means such as rock riprap, asphalt, concrete, etc.
4. **Freeboard:** Freeboard is the difference between the design flow elevation in the auxiliary spillway and the top of the settled embankment. The minimum freeboard for Class 2 and Class 3 basins shall be 1 foot.

Embankment (Earth Fill)

Class 1 basins: The minimum top width shall be 10 feet. The upstream slope shall be no steeper than 3:1. The downstream slope shall be no steeper than 5:1.

Class 2 basins: The minimum top width shall be 8 feet. The combined upstream and downstream side slopes shall not be less than 5:1 with neither slope steeper than 2½:1.

Class 3 basins: The minimum top width shall be 10 feet. Side slopes shall be no steeper than 3:1.

Embankment (other than Earth Fill)

Class 1 basins only: The embankment may be constructed

of the following materials:

1. Pressure treated timber crib – rock filled
2. Precast reinforced concrete crib – rock filled
3. Gabions

When the above material is used for the embankment, a principal spillway is not required; however, the dam shall be pervious to allow for drainage during time of low inflow. Basins constructed of the above materials should be used only when the sediment to be trapped is coarse-grained material such as well graded gravel (GW) or poorly graded gravel (GP) material (Unified Soil Classification System).

Construction Specifications

Site Preparation

Areas under the embankment and any structural works shall be cleared, grubbed, and the topsoil stripped to remove trees, vegetation, roots, and other objectionable material. In order to facilitate cleanout and restoration, the pool area will be cleared of all brush and excess trees.

Cutoff Trench

A cutoff trench shall be excavated along the centerline of dam on earth fill embankments to a depth of at least 1.0 foot into a layer of slowly permeable material. The minimum depth shall be 2 feet. The cutoff trench shall extend up both abutments to the riser crest elevation. The minimum bottom width shall be 4 feet, but wide enough to permit operation of compaction equipment. The side slopes shall be the same as those for embankment. The trench shall be kept free from standing water during the backfilling operations.

Embankment

The fill material shall be taken from approved designated borrow areas. It shall be free of roots, woody vegetation, oversized stones, rocks, or other objectionable material. Areas on which fill is to be placed shall be scarified prior to placement of fill. The fill material should contain sufficient moisture so that it can be formed into a ball without crumbling. If water can be squeezed out of the ball, it is too wet for proper compaction.

Fill material will be placed in 6 to 9 inch layers and shall be continuous over the entire length of the fill. Compaction will be obtained by routing the hauling equipment over the fill so that the entire surface of the fill is traversed by at least one track width of the equipment, or compaction shall be achieved by the use of a compactor. The embankment shall be constructed to an elevation 10 percent higher than the design height to allow for settlement if compaction is obtained with hauling equipment. If compactors are used for compaction, the overbuild may be reduced to 5 percent.

Pipe Spillway

The riser shall be solidly attached to the barrel and all connections shall be watertight. The barrel and riser shall be placed on a firm foundation. The fill material around the pipe spillway will be placed in 4-inch layers and compacted to at least the same density as the adjacent embankment.

Auxiliary Spillway (Class 2 and 3 basins)

The auxiliary spillway shall be installed in undisturbed earth unless otherwise specified in the plan. The lines and grades must conform to those shown on the plans as nearly as skillful operation of the excavating equipment will permit.

Embankment (other than Earth Fill)

The rock used to fill cribbing or gabions will be hard and durable and of an approved size and gradation.

Erosion and Pollution Control

Construction operations will be carried out in such a manner that erosion and water pollution will be minimized. State and local laws concerning pollution abatement shall be complied with.

Safety

State requirements shall be met concerning fencing and signs warning the public of hazards of soft sediment and floodwater.

Seeding

Seeding, fertilizing, and mulching shall conform to the recommendations in Section 5, Vegetative Measures for Erosion and Sediment Control, of this manual.

Final Disposal

In the case of temporary structures, when the intended purpose has been accomplished and the drainage area properly stabilized, the embankment and resulting silt deposits are to be leveled, or otherwise disposed of in accordance with the plan.

Figure 5B.21
One-Year Debris Basin Sediment Capacity (USDA - NRCS)

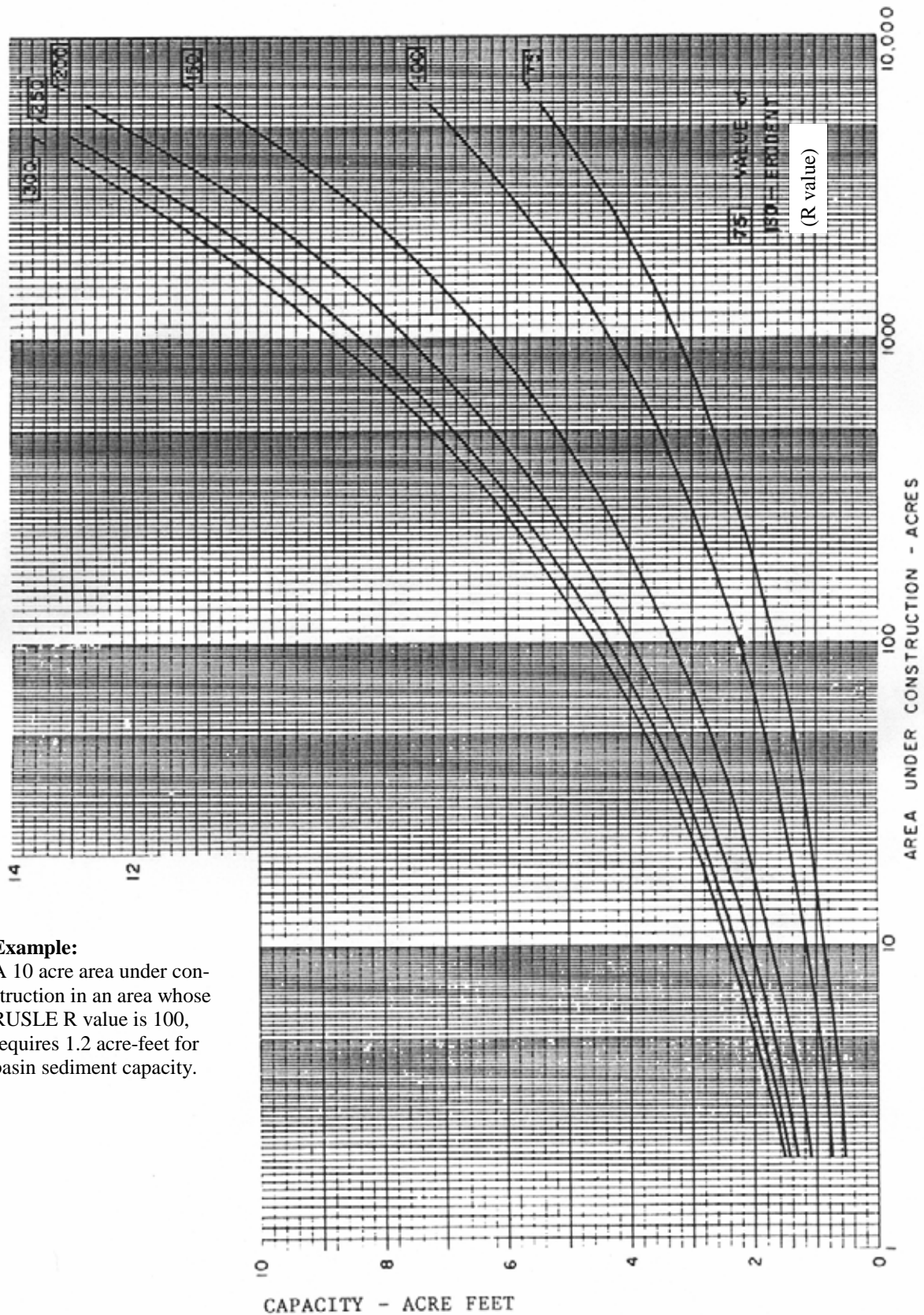

Example:
 A 10 acre area under construction in an area whose RUSLE R value is 100, requires 1.2 acre-feet for basin sediment capacity.

STANDARD AND SPECIFICATIONS FOR SUBSURFACE DRAIN



Definition

A conduit, such as tile, pipe, or tubing, installed beneath the ground surface, which intercepts, collects, and/or conveys drainage water.

Purpose

A subsurface drain may serve one or more of the following purposes:

1. Improve the environment for vegetative growth by regulating the water table and groundwater flow.
2. Intercept and prevent water movement into a wet area.
3. Relieve artesian pressures.
4. Remove surface runoff.
5. Provide internal drainage of slopes to improve their stability and reduce erosion.
6. Provide internal drainage behind bulkheads, retaining walls, etc.
7. Replace existing subsurface drains that are interrupted or destroyed by construction operations.
8. Provide subsurface drainage for dry storm water management structures.
9. Improve dewatering of sediment in sediment basins. (See Standard and Specification for Sediment Basins in Section 5A).

Conditions Where Practice Applies

Subsurface drains are used in areas having a high water table or where subsurface drainage is required. The soil shall have enough depth and permeability to permit installation of an effective system. This standard does not apply to storm drainage systems or foundation drains. Regulatory restrictions may apply if wetlands are present.

An outlet for the drainage system shall be available, either by gravity flow or by pumping. The outlet shall be adequate for the quantity of water to be discharged without causing damage above or below the point of discharge and shall comply with all state and local laws.

Design Criteria

The design and installation shall be based on adequate surveys and on-site soils investigations.

Required Capacity of Drains

The required capacity shall be determined by one or more of the following:

1. Where sub-surface drainage is to be uniform over an area through a systematic pattern of drains, a drainage coefficient of 1 inch to be removed in 24 hours shall be used; see Drain Chart, Figure 5B.22 on page 5B.48.
2. Where sub-surface drainage is to be by a random interceptor system, a minimum inflow rate of 0.5 cfs per 1,000 feet of line shall be used to determine the required capacity. If actual field tests and measurements of flow amounts are available, they may be used for determining capacity.

For interceptor subsurface drains on sloping land, increase the inflow rate as follows:

<u>Land Slope</u>	<u>Increase Inflow Rate By</u>
2-5 percent	10 percent
5-12 percent	20 percent
Over 12 percent	30 percent

3. Additional design capacity must be provided if surface water is allowed to enter the system.

Size of Subsurface Drain

The size of subsurface drains shall be determined from the drain chart found on Figures 5B.22 on page 5B.48. All subsurface drains shall have a nominal diameter, which equals or exceeds four (4) inches.

Depth and Spacing

The minimum depth of cover of subsurface drains shall be 24 inches where possible. The minimum depth of cover may be reduced to 15 inches where it is not possible to attain the 24 inch depth and where the drain is not subject to equipment loading or frost action. Roots from some types of vegetation can plug drains, as the drains get closer to the surface.

The spacing of drain laterals will be dependent on the permeability of the soil, the depth of installation of the drains and degree of drainage required. Generally, drains installed 36 inches deep and spaced 50 feet center-to-center will be adequate. For more specific information, see the New York Drainage Guide (USDA-NRCS).

Minimum Velocity and Grade

The minimum grade for subsurface drains shall be 0.10 percent. Where surface water enters the system a velocity of not less than 2 feet per second shall be used to establish the minimum grades. Provisions shall be made for preventing debris or sediment from entering the system by means of filters or collection and periodic removal of sediment from installed traps.

Materials for Subsurface Drains

Acceptable subsurface drain materials include perforated, continuous closed joint conduits of polyethylene plastic, concrete, corrugated metal, asbestos cement, bituminized fiber, polyvinyl chloride, and clay tile.

The conduit shall meet strength and durability requirements of the site.

Loading

The allowable loads on subsurface drain conduits shall be based on the trench and bedding conditions specified for the job. A factor of safety of not less than 1.5 shall be used in computing the maximum allowable depth of cover for a particular type of conduit.

Envelopes and Envelope Materials

Envelopes shall be used around subsurface drains for proper bedding and to provide better flow into the conduit. Not less than three inches of envelope material shall be used for

sand/gravel envelopes. Where necessary to improve the characteristics of flow of groundwater into the conduit, more envelope material may be required.

Where county regulations do not allow sand/gravel envelopes, but require a special type and size of envelope material, they shall be followed.

Envelope material shall be placed to the height of the uppermost seepage strata. Behind bulkheads and retaining walls, it shall go to within twelve inches of the top of the structure. This standard does not cover the design of filter materials where needed.

Materials used for envelopes shall not contain materials which will cause an accumulation of sediment in the conduit or render the envelope unsuitable for bedding of the conduit. Envelope materials shall consist of either filter cloth or sand/gravel material, which shall pass a 1 ½ inch sieve, 90 to 100 percent shall pass a ¾ inch sieve, and not more than 10 percent shall pass a No. 60 sieve.

Filter cloth envelope can be either woven or non-woven monofilament yarns and shall have a sieve opening ranging from 40 to 80. The envelope shall be placed in such a manner that once the conduit is installed, it shall completely encase the conduit.

The conduit shall be placed and bedded in a sand/gravel envelope. A minimum of three inches depth of envelope materials shall be placed on the bottom of a conventional trench. The conduit shall be placed on this and the trench completely filled with envelope material to minimum depth of 3 inches above the conduit.

Soft or yielding soils under the drain shall be stabilized where required and lines protected from settlement by adding gravel or other suitable material to the trench, by placing the conduit on plank or other rigid support, or by using long sections of perforated or watertight pipe with adequate strength to ensure satisfactory subsurface drain performance.

Use of Heavy Duty Corrugated Plastic Drainage Tubing

Heavy duty corrugated drainage tubing shall be specified where rocky or gravelly soils are expected to be encountered during installation operations. The quality of tubing will also be specified when cover over this tubing is expected to exceed 24 inches for 4, 5, 6, or 8 inch tubing. Larger size tubing designs will be handled on an individual job basis.

Auxiliary Structure and Subsurface Drain Protection

The outlet shall be protected against erosion and undermining of the conduit, against damaging periods of submergence, and against entry of rodents or other animals

into the subsurface drain. An animal guard shall be installed on the outlet end of the pipe. A swinging animal guard shall be used if surface water enters the pipe.

A continuous 10-foot section of corrugated metal, cast iron, polyvinyl chloride, or steel pipe without perforations shall be used at the outlet end of the line and shall outlet 1.0 foot above the normal elevation of low flow in the outlet ditch or above mean high tide in tidal areas. No envelope material shall be used around the 10-foot section of pipe. Two-thirds of the pipe shall be buried in the ditch bank and the cantilevered section shall extend to a point above the toe of the ditch side slope. If not possible, the side slope shall be protected from erosion.

Conduits under roadways and embankments shall be watertight and designed to exclude debris and prevent sediment from entering the conduit. Lines flowing under pressure shall be designed to withstand the resulting pressures and velocity of flow. Surface waterways shall be used where feasible.

The upper end of each subsurface drain line shall be capped with a tight fitting cap of the same material as the conduit or other durable material unless connected to a structure.

Construction Specifications

1. Deformed, warped, or otherwise damaged pipe or tubing shall not be used.
2. All subsurface drains shall be laid to a uniform line

and covered with envelope material. The pipe or tubing shall be laid with the perforations down and oriented symmetrically about the vertical centerline. Connections will be made with manufactured functions comparable in strength with the specified pipe or tubing unless otherwise specified. The method of placement and bedding shall be as specified on the drawing.

3. Envelope material shall consist of filter cloth or a sand/gravel (which shall pass the 1 ½ inch sieve, 90 to 100 percent shall pass ¾ inch sieve, and not more than 10 percent shall pass the No. 60 sieve).
4. The upper end of each subsurface drain line shall be capped with a tight fittings cap of the same material as the conduit or other durable material unless connected to a structure.
5. A continuous 10-foot section of corrugated metal, cast iron, polyvinyl chloride, or steel pipe without perforations shall be used at the outlet end of the line. No envelope material shall be used around the 10-foot section of the pipe. An animal guard shall be installed on the outlet end of the pipe.
6. Earth backfill material shall be placed in the trench in such a manner that displacement of the drain will not occur.
7. Where surface water is entering the system, the pipe outlet section of the system shall contain a swing type trash and animal guard.

Figure 5B.22
Drain Chart—Corrugated Plastic Drain Tubing (USDA - NRCS)

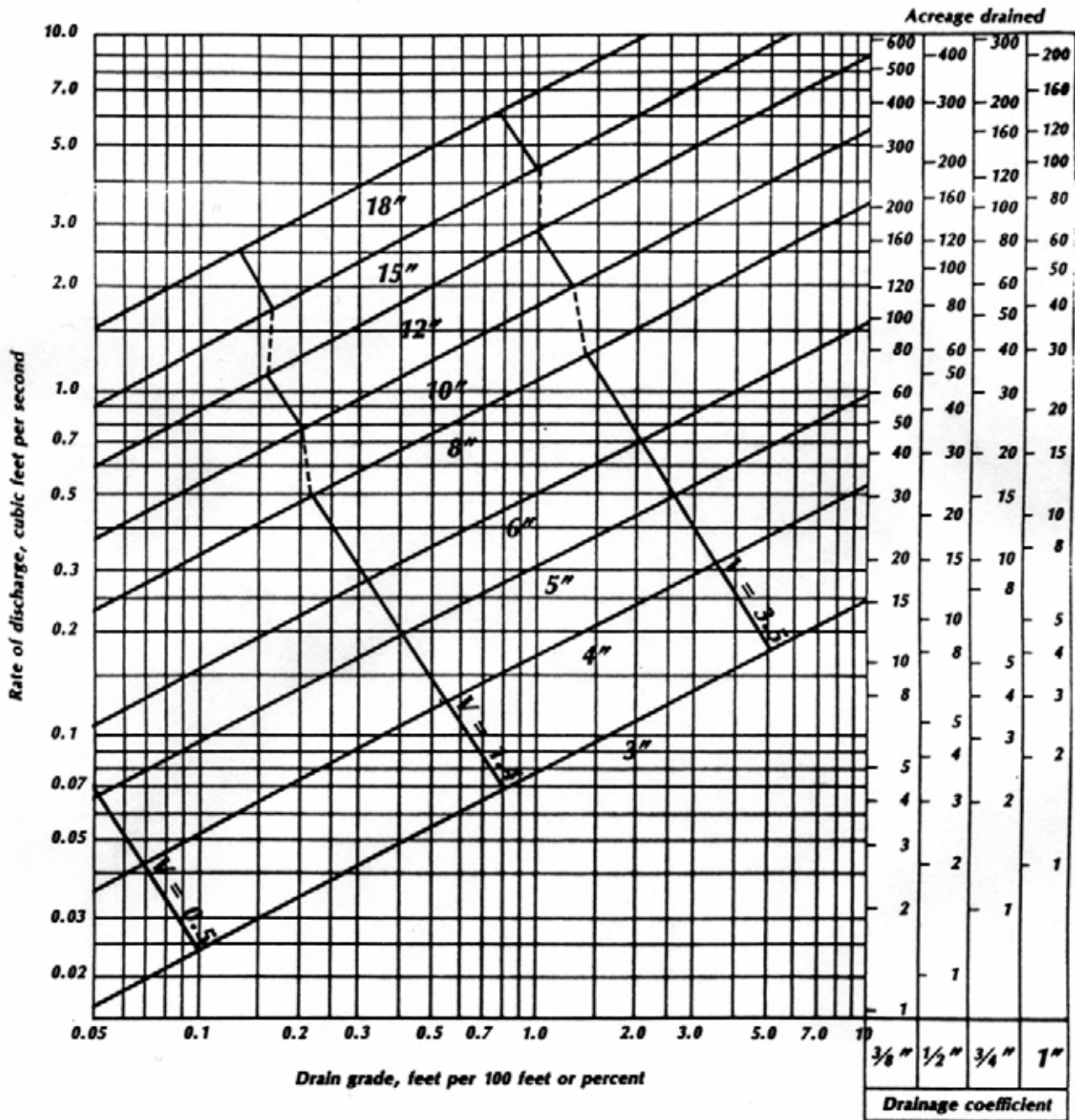

STANDARD AND SPECIFICATIONS FOR LANDGRADING



Definition

Reshaping of the existing land surface in accordance with a plan as determined by engineering survey and layout.

Purpose

The purpose of a landgrading specification is to provide for erosion control and vegetative establishment on those areas where the existing land surface is to be reshaped by grading according to plan.

Design Criteria

The grading plan should be based upon the incorporation of building designs and street layouts that fit and utilize existing topography and desirable natural surrounding to avoid extreme grade modifications. Information submitted must provide sufficient topographic surveys and soil investigations to determine limitations that must be imposed on the grading operation related to slope stability, effect on adjacent properties and drainage patterns, measures for drainage and water removal, and vegetative treatment, etc.

Many counties have regulations and design procedures already established for land grading and cut and fill slopes. Where these requirements exist, they shall be followed.

The plan must show existing and proposed contours of the area(s) to be graded. The plan shall also include practices for erosion control, slope stabilization, safe disposal of runoff water and drainage, such as waterways, lined ditches, reverse slope benches (include grade and cross section), grade stabilization structures, retaining walls, and surface and subsurface drains. The plan shall also include phasing

of these practices. The following shall be incorporated into the plan:

1. Provisions shall be made to safely conduct surface runoff to storm drains, protected outlets, or to stable water courses to ensure that surface runoff will not damage slopes or other graded areas; see standards and specifications for Grassed Waterway, Diversion, Grade Stabilization Structure.
2. Cut and fill slopes that are to be stabilized with grasses shall not be steeper than 2:1. When slopes exceed 2:1, special design and stabilization consideration are required and shall be adequately shown on the plans. (Note: Where the slope is to be mowed, the slope should be no steeper than 3:1, although 4:1 is preferred because of safety factors related to mowing steep slopes.)
3. Reverse slope benches or diversion shall be provided whenever the vertical interval (height) of any 2:1 slope exceeds 20 feet; for 3:1 slope it shall be increased to 30 feet and for 4:1 to 40 feet. Benches shall be located to divide the slope face as equally as possible and shall convey the water to a stable outlet. Soils, seeps, rock outcrops, etc., shall also be taken into consideration when designing benches.
 - A. Benches shall be a minimum of six feet wide to provide for ease of maintenance.
 - B. Benches shall be designed with a reverse slope of 6:1 or flatter to the toe of the upper slope and with a minimum of one foot in depth. Bench gradient to the outlet shall be between 2 percent and 3 percent, unless accompanied by appropriate design and computations.
 - C. The flow length within a bench shall not exceed 800 feet unless accompanied by appropriate design and computations; see Standard and Specifications for Diversion on page 5B.1
4. Surface water shall be diverted from the face of all cut and/or fill slopes by the use of diversions, ditches and swales or conveyed downslope by the use of a designed structure, except where:
 - A. The face of the slope is or shall be stabilized and the face of all graded slopes shall be protected from surface runoff until they are stabilized.

- B. The face of the slope shall not be subject to any concentrated flows of surface water such as from natural drainage ways, graded swales, downspouts, etc.
- C. The face of the slope will be protected by special erosion control materials, sod, gravel, riprap, or other stabilization method.
5. Cut slopes occurring in ripable rock shall be serrated as shown in Figure 5B.23 on page 5B.51. The serrations shall be made with conventional equipment as the excavation is made. Each step or serration shall be constructed on the contour and will have steps cut at nominal two-foot intervals with nominal three-foot horizontal shelves. These steps will vary depending on the slope ratio or the cut slope. The nominal slope line is 1 ½: 1. These steps will weather and act to hold moisture, lime, fertilizer, and seed thus producing a much quicker and longer-lived vegetative cover and better slope stabilization. Overland flow shall be diverted from the top of all serrated cut slopes and carried to a suitable outlet.
 6. Subsurface drainage shall be provided where necessary to intercept seepage that would otherwise adversely affect slope stability or create excessively wet site conditions.
 7. Slopes shall not be created so close to property lines as to endanger adjoining properties without adequately protecting such properties against sedimentation, erosion, slippage, settlement, subsidence, or other related damages.
 8. Fill material shall be free of brush, rubbish, rocks, logs, stumps, building debris, and other objectionable material. It should be free of stones over two (2) inches in diameter where compacted by hand or mechanical tampers or over eight (8) inches in diameter where compacted by rollers or other equipment. Frozen material shall not be placed in the fill nor shall the fill material be placed on a frozen foundation.
 9. Stockpiles, borrow areas, and spoil shall be shown on the plans and shall be subject to the provisions of this Standard and Specifications.
 10. All disturbed areas shall be stabilized structurally or vegetatively in compliance with the Standard and Specifications for Critical Area Treatment in Section 3.
1. All graded or disturbed areas, including slopes, shall be protected during clearing and construction in accordance with the erosion and sediment control plan until they are adequately stabilized.
 2. All erosion and sediment control practices and measures shall be constructed, applied and maintained in accordance with the sediment control plan and the "New York Standards and Specifications for Erosion and Sediment Control."
 3. Topsoil required for the establishment of vegetation shall be stockpiled in amount necessary to complete finished grading of all exposed areas.
 4. Areas to be filled shall be cleared, grubbed, and stripped of topsoil to remove trees, vegetation, roots, or other objectionable material.
 5. Areas that are to be topsoiled shall be scarified to a minimum depth of four inches prior to placement of topsoil.
 6. All fills shall be compacted as required to reduce erosion, slippage, settlement, subsidence, or other related problems. Fill intended to support buildings, structures, and conduits, etc., shall be compacted in accordance with local requirements or codes.
 7. All fill shall be placed and compacted in layers not to exceed 9 inches in thickness.
 8. Except for approved landfills or nonstructural fills, fill material shall be free of frozen particles, brush, roots, sod, or other foreign objectionable materials that would interfere with, or prevent, construction of satisfactory fills.
 9. Frozen material or soft, mucky or highly compressible materials shall not be incorporated into fill slopes or structural fills.
 10. Fill shall not be placed on saturated or frozen surfaces.
 11. All benches shall be kept free of sediment during all phases of development.
 12. Seeps or springs encountered during construction shall be handled in accordance with the Standard and Specification for Subsurface Drain on page 5B.44 or other approved methods.
 13. All graded areas shall be permanently stabilized immediately following finished grading.
 14. Stockpiles, borrow areas, and spoil areas shall be shown on the plans and shall be subject to the provisions of this Standard and Specifications.

Construction Specifications

See Figures 5B.23 and 5B.24 for details.

Figure 5B.23
Typical Section of Serrated Cut Slope

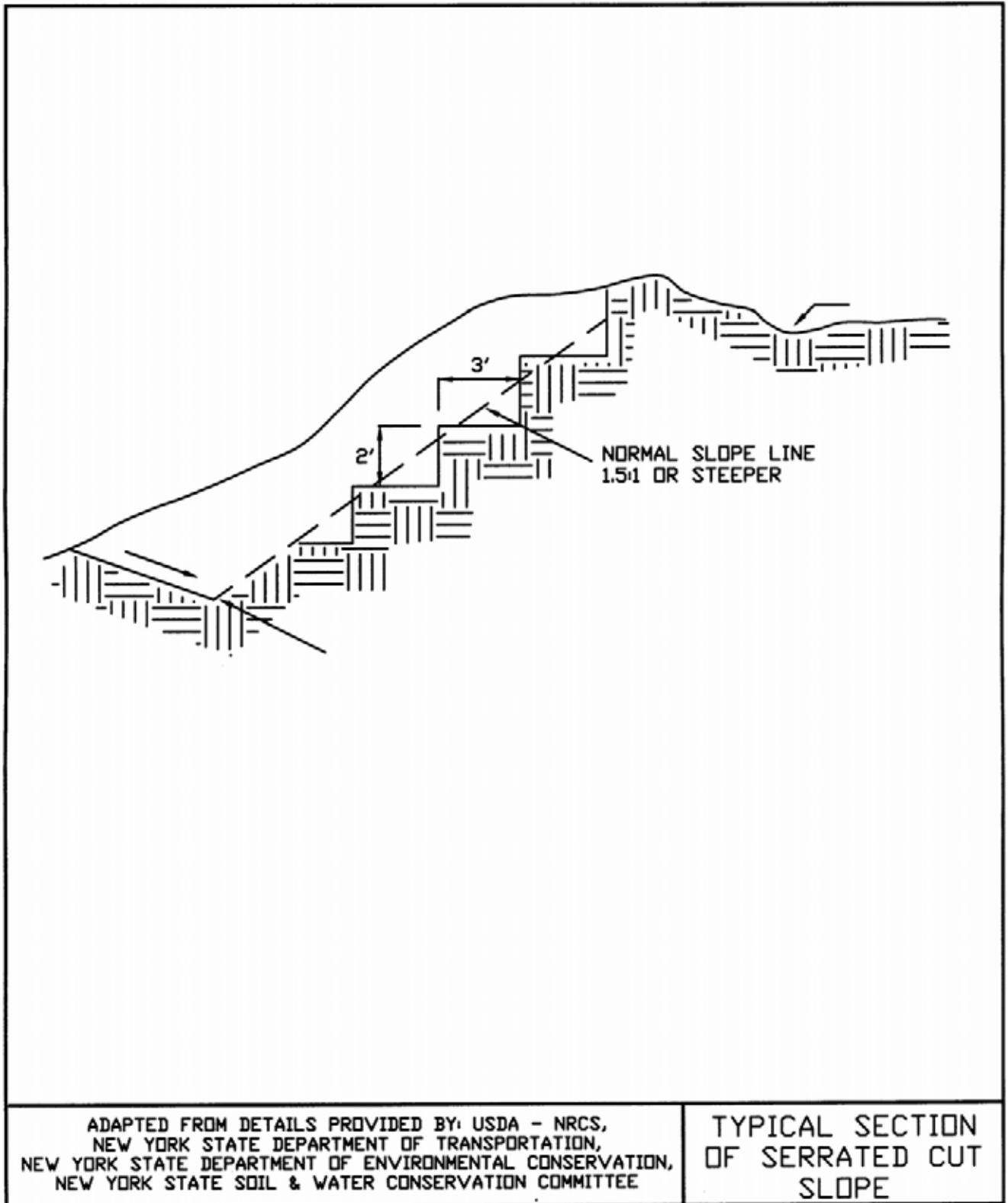

Figure 5B.24 (1)
Landgrading

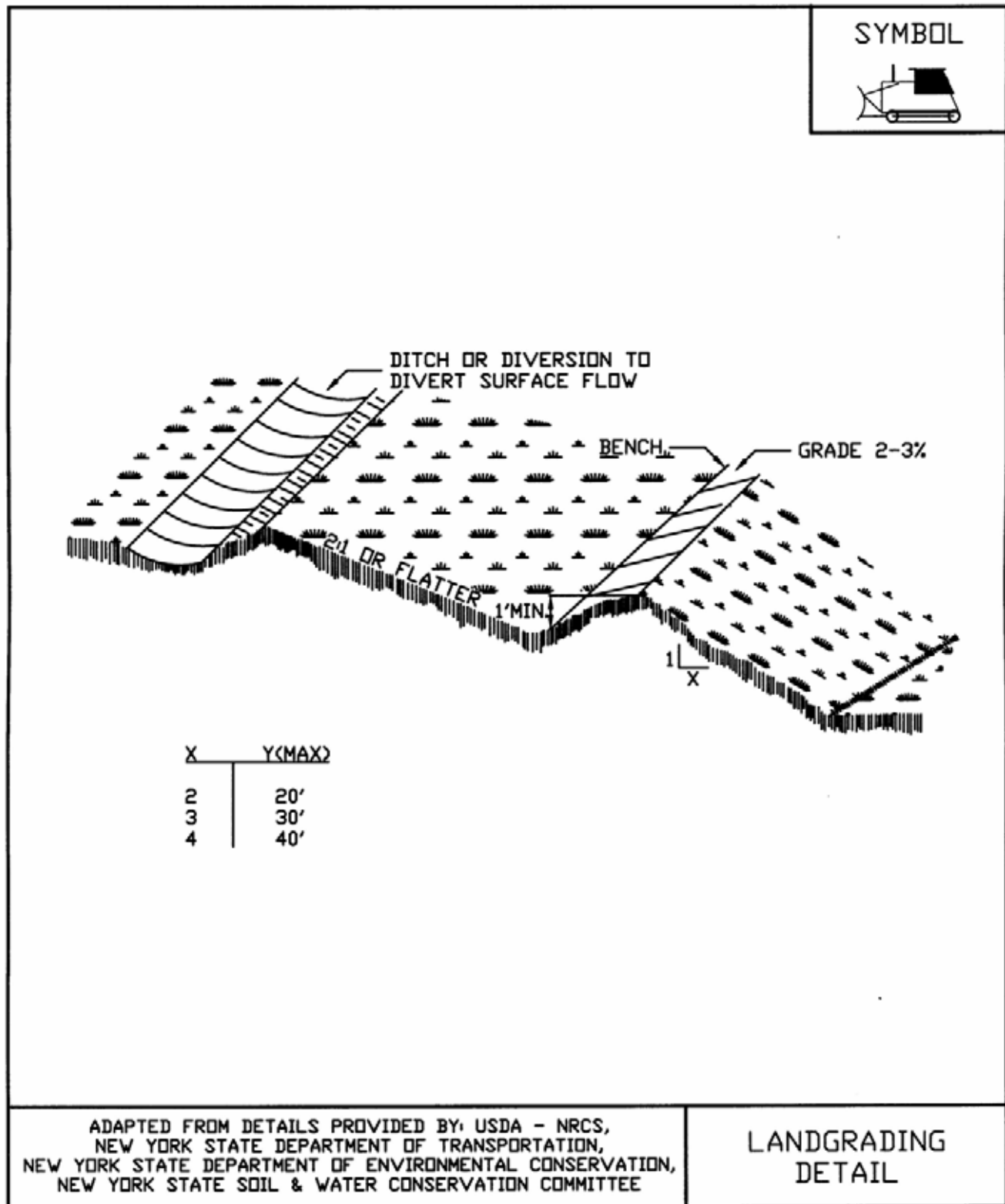

Figure 5B.24 (2)
Landgrading —Construction Specifications

CONSTRUCTION SPECIFICATIONS

1. ALL GRADED OR DISTURBED AREAS INCLUDING SLOPES SHALL BE PROTECTED DURING CLEARING AND CONSTRUCTION IN ACCORDANCE WITH THE APPROVED SEDIMENT CONTROL PLAN UNTIL THEY ARE PERMANENTLY STABILIZED.
2. ALL SEDIMENT CONTROL PRACTICES AND MEASURES SHALL BE CONSTRUCTED, APPLIED AND MAINTAINED IN ACCORDANCE WITH THE APPROVED SEDIMENT CONTROL PLAN AND THE "STANDARDS AND SPECIFICATIONS FOR SOIL EROSION AND SEDIMENT CONTROL IN DEVELOPING AREAS".
3. TOPSOIL REQUIRED FOR THE ESTABLISHMENT OF VEGETATION SHALL BE STOCKPILED IN AMOUNT NECESSARY TO COMPLETE FINISHED GRADING OF ALL EXPOSED AREAS.
4. AREAS TO BE FILLED SHALL BE CLEARED, GRUBBED, AND STRIPPED OF TOPSOIL TO REMOVE TREES, VEGETATION, ROOTS OR OTHER OBJECTIONABLE MATERIAL.
5. AREAS WHICH ARE TO BE TOPSOILED SHALL BE SCARIFIED TO A MINIMUM DEPTH OF FOUR INCHES PRIOR TO PLACEMENT OF TOPSOIL.
6. ALL FILLS SHALL BE COMPACTED AS REQUIRED TO REDUCE EROSION, SLIPPAGE, SETTLEMENT, SUBSIDENCE OR OTHER RELATED PROBLEMS. FILL INTENDED TO SUPPORT BUILDINGS, STRUCTURES AND CONDUITS, ETC. SHALL BE COMPACTED IN ACCORDANCE WITH LOCAL REQUIREMENTS OR CODES.
7. ALL FILL TO BE PLACED AND COMPACTED IN LAYERS NOT TO EXCEED 9 INCHES IN THICKNESS.
8. EXCEPT FOR APPROVED LANDFILLS, FILL MATERIAL SHALL BE FREE OF FROZEN PARTICLES, BRUSH, ROOTS, SOD, OR OTHER FOREIGN OR OTHER OBJECTIONABLE MATERIALS THAT WOULD INTERFERE WITH OR PREVENT CONSTRUCTION OF SATISFACTORY FILLS.
9. FROZEN MATERIALS OR SOFT, MUCKY OR HIGHLY COMPRESSIBLE MATERIALS SHALL NOT BE INCORPORATED IN FILLS.
10. FILL SHALL NOT BE PLACED ON SATURATED OR FROZEN SURFACES.
11. ALL BENCHES SHALL BE KEPT FREE OF SEDIMENT DURING ALL PHASES OF DEVELOPMENT.
12. SEEPS OR SPRINGS ENCOUNTERED DURING CONSTRUCTION SHALL BE HANDLED IN ACCORDANCE WITH THE STANDARD AND SPECIFICATION FOR SUBSURFACE DRAIN OR OTHER APPROVED METHOD.
13. ALL GRADED AREAS SHALL BE PERMANENTLY STABILIZED IMMEDIATELY FOLLOWING FINISHED GRADING.
14. STOCKPILES, BORROW AREAS AND SPOIL AREAS SHALL BE SHOWN ON THE PLANS AND SHALL BE SUBJECT TO THE PROVISIONS OF THIS STANDARD AND SPECIFICATION.

ADAPTED FROM DETAILS PROVIDED BY: USDA - NRCS,
NEW YORK STATE DEPARTMENT OF TRANSPORTATION,
NEW YORK STATE DEPARTMENT OF ENVIRONMENTAL CONSERVATION,
NEW YORK STATE SOIL & WATER CONSERVATION COMMITTEE

LANDGRADING
SPECIFICATIONS

STANDARD AND SPECIFICATIONS FOR SURFACE ROUGHENING



Definition

Roughening a bare soil surface whether through creating horizontal grooves across a slope, stair-stepping, or tracking with construction equipment.

Purpose

To aid the establishment of vegetative cover from seed, to reduce runoff velocity and increase infiltration, and to reduce erosion and provide for trapping of sediment.

Conditions Where Practice Applies

All construction slopes require surface roughening to facilitate stabilization with vegetation, particularly slopes steeper than 3:1.

Design Criteria

There are many different methods to achieve a roughened soil surface on a slope. No specific design criteria is required. However, the selection of the appropriate method depends on the type of slope. Methods include tracking, grooving, and stair-stepping. Steepness, mowing requirements, and/or a cut or fill slope operation are all factors considered in choosing a roughening method.

Construction Specifications

A. Cut Slope, No mowing.

1. Stair-step grade or groove cut slopes with a gradient steeper than 3:1 (Figure 5B.25).
2. Use stair-step grading on any erodible material soft

enough to be ripped with a bulldozer. Slopes of soft rock with some soil are particularly suited to stair-step grading.

3. Make the vertical cut distance less than the horizontal distance, and slightly slope the horizontal position of the “step” to the vertical wall.
4. Do not make vertical cuts more than 2 feet in soft materials or 3 feet in rocky materials.

Grooving uses machinery to create a series of ridges and depressions that run perpendicular to the slope following the contour. Groove using any appropriate implement that can be safely operated on the slope, such as disks, tillers, spring harrows, or the teeth of a front-end loader bucket. Do not make the grooves less than 3 inches deep or more than 15 inches apart.

B. Fill Slope, No mowing

1. Place fill to create slopes with a gradient steeper than 3:1 in lifts 9 inches or less and properly compacted. Ensure the face of the slope consists of loose, uncompacted fill 4 to 6 inches deep. Use grooving as described above to roughen the slope, if necessary.
2. Do not blade or scrape the final slope face.

C. Cuts/Fills, Mowed Maintenance

1. Make mowed slopes no steeper than 3:1.
2. Roughen these areas to shallow grooves by normal tilling, disking, harrowing, or use of cultipacker-seeder. Make the final pass of such tillage equipment on the contour.
3. Make grooves at least 1 inch deep and a maximum of 10 inches apart.
4. Excessive roughness is undesirable where mowing is planned.

Tracking should be used primarily in sandy soils to avoid undue compaction of the soil surface. Tracking is generally not as effective as the other roughening methods described. (It has been used as a method to track down mulch.) Operate tracked machinery up and down the slope to leave horizontal depressions in the soil. Do not back-blade during the final grading operation.

Figure 5B.25
Surface Roughening

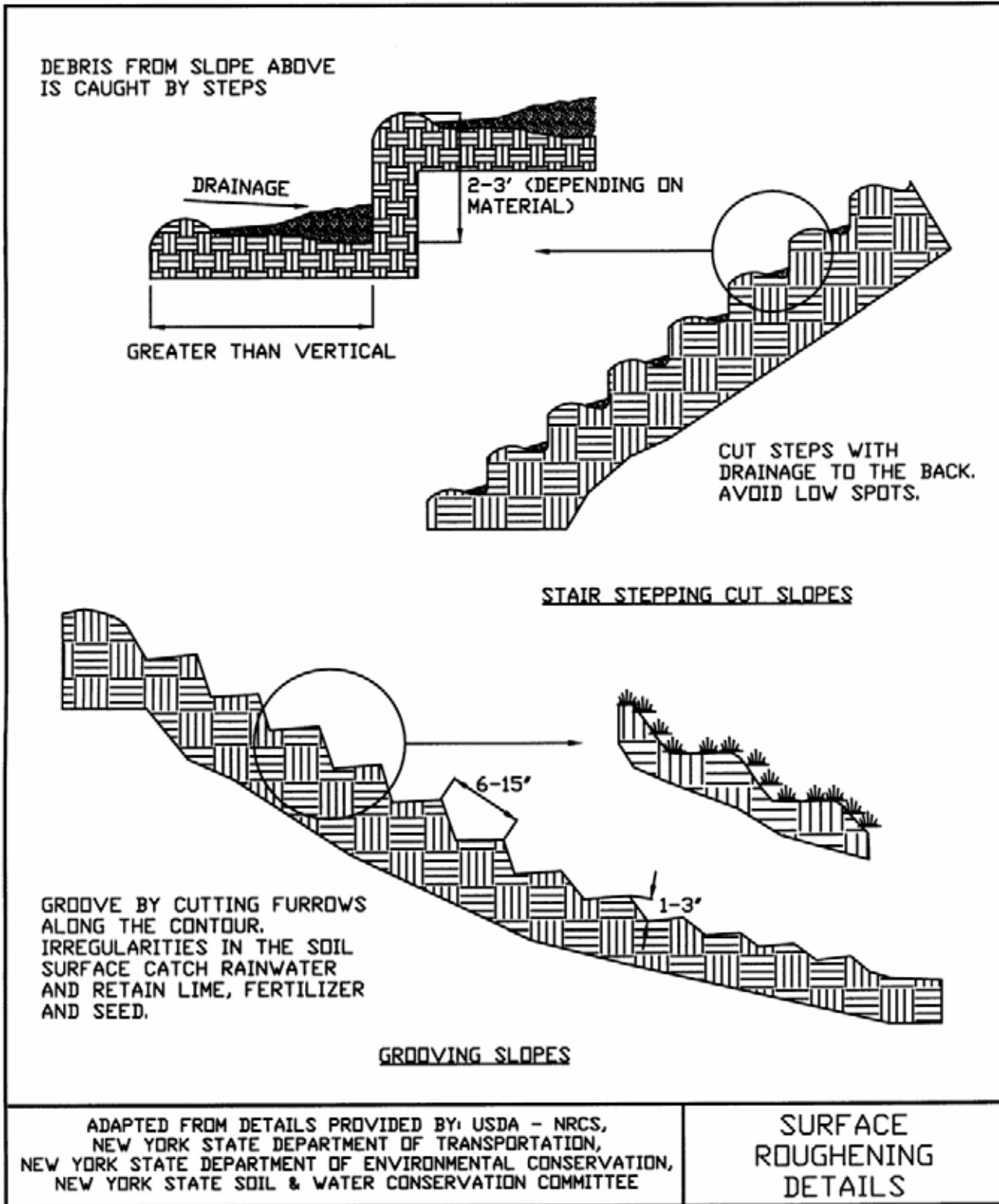

STANDARD AND SPECIFICATIONS FOR RIPRAP SLOPE PROTECTION



Definition

A layer of stone designed to protect and stabilize areas subject to erosion.

Purpose

To protect the soil surface from erosive forces and/or improve the stability of soil slopes that are subject to seepage or have poor soil structure.

Conditions Where Practice Applies

Riprap is used for cut and fill slopes subject to seepage, erosion, or weathering, particularly where conditions prohibit the establishment of vegetation. Riprap is also used for channel side slopes and bottoms, streambanks, grade sills, on shorelines subject to erosion, and at inlets and outlets to culverts, bridges, slope drains, grade stabilization structures, and storm drains.

Design Criteria

Gradation – Riprap should be a well-graded mixture with 50% by weight larger than the specified design size. The diameter of the largest stone size in such a mixture should be 1.5 times the d_{50} size with smaller sizes grading down to 1 inch. The designer should select the size or sizes that equal or exceed that minimum size based on riprap gradations commercially available in the area.

Thickness – The minimum layer thickness should be 1.5 times the maximum stone diameter, but in no case less than 6 inches.

Quality – Stone for riprap should be hard, durable field or quarry materials. They should be angular and not subject to breaking down when exposed to water or weathering. The specific gravity should be at least 2.5.

Size – The sizes of stones used for riprap protection are determined by purpose and specific site conditions:

1. Slope Stabilization – Riprap stone for slope stabilization not subject to flowing water or wave action should be sized for the proposed grade. The gradient of the slope to be stabilized should be less than the natural angle of repose of the stone selected. Angles of repose of riprap stones may be estimated from Figure 5B.26.

Riprap used for surface stabilization of slopes does not add significant resistance to sliding or slope failure and should not be considered a retaining wall. Slopes approaching 1.5:1 may require special stability analysis. The inherent stability of the soil must be satisfactory before riprap is used for surface stabilization.

2. Outlet Protection – Design criteria for sizing stone and determining dimensions of riprap aprons are presented in Standards and Specifications for Rock Outlet Protection.
3. Streambank Protection – Design criteria for sizing stone for stability of channel bank are presented in Standard and Specifications for Structural Streambank Protection.

Filter Blanket – A filter blanket is a layer of material placed between the riprap and the underlying soil to prevent soil movement into or through the riprap. A suitable filter may consist of a well-graded gravel or sand-gravel layer or a synthetic filter fabric manufactured for this purpose. The design of a gravel filter blanket is based on the ratio of particle size in the overlying filter material to that of the base material in accordance with the criteria below. Multiple layers may be designed to affect a proper filter if necessary.

A gravel filter blanket should have the following relationship for a stable design:

$$\frac{d_{15} \text{ filter}}{d_{85} \text{ base}} \leq 5$$

$$5 < \frac{d_{15} \text{ filter}}{d_{50} \text{ base}} \leq 20$$

and

$$\frac{d_{50} \text{ filter}}{d_{50} \text{ base}} \leq 40$$

Filter refers to the overlying material while base refers to the underlying material. These relationships must hold between the base and filter and the filter and riprap to prevent migration of material. In some cases, more than one filter may be needed. Each filter layer should be a minimum of 6 inches thick, unless an acceptable filter fabric is used.

A synthetic filter fabric may be used with or in place of gravel filters. The following particle size relationships should exist:

1. Filter fabric covering a base containing 50% or less by weight of fine particles (#200 sieve size):
 - a. $\frac{d_{85} \text{ base (mm)}}{\text{EOS} * \text{filter fabric (mm)}} > 1$
 - b. total open area of filter fabric should not exceed 36%
2. Filter fabric covering other soils:
 - a. EOS is no larger than 0.21 mm (#70 sieve size)
 - b. total open area of filter fabric should not exceed 10%

*EOS – Equivalent opening size compared to a U.S. standard sieve size.

No filter fabric should have less than 4% open area or an EOS less than U.S. Standard Sieve #100 (0.15 mm). The permeability of the fabric must be greater than that of the soil. The fabric may be made of woven or nonwoven monofilament yarns and should meet the following minimum requirements:

Thickness 20-60 mils

grab strength 90-120 lbs.

conform to ASTM D-1682 or ASTM D-177

Filter blankets should always be provided where seepage is significant or where flow velocity and duration of flow or turbulence may cause underlying soil particles to move through the riprap.

Construction Specifications

Subgrade Preparation – Prepare the subgrade for riprap

and filter to the required lines and grades shown on the plans. Compact any fill required in the subgrade to a density approximating that of the undisturbed material or overfill depressions with riprap. Remove brush, trees, stumps, and other objectionable material. Cut the subgrade sufficiently deep so that the finished grade of the riprap will be at the elevation of the surrounding area. Channels should be excavated sufficiently to allow placement of the riprap in a manner such that the finished inside dimensions and grade of the riprap meet design specifications.

Sand and gravel filter blanket – Place the filter blanket immediately after the ground foundation is prepared. For gravel, spread filter stone in a uniform layer to the specified depth. Where more than one layer of filter material is used, spread the layers with minimal mixing.

Synthetic filter fabric – Place the cloth directly on the prepared foundation. Overlap the edges by at least 2 feet, and space the anchor pins every 3 feet along the overlap. Bury the upper and lower ends of the cloth a minimum of 12 inches below ground. Take precautions not to damage the cloth by dropping the riprap. If damage occurs, remove the riprap and repair the sheet by adding another layer of filter fabric with a minimum overlap of 12 inches around the damaged area. Where large stones are to be placed, a 4-inch layer of fine sand or gravel is recommended to protect the filter cloth. Filter fabric is not recommended as a filter on slopes steeper than 2 horizontal to 1 vertical.

Stone placement – Placement of the riprap should follow immediately after placement of the filter. Place riprap so that it forms dense, well-graded mass of stone with a minimum of voids. The desired distribution of stones throughout the mass may be obtained by selective loading at the quarry and controlled dumping during final placement. Place riprap to its full thickness in one operation. Do not place riprap by dumping through chutes or other methods that cause segregation of stone sizes. Be careful not to dislodge the underlying base or filter when placing the stones.

The toe of the riprap should be keyed into a stable foundation at its base as shown in Figure 5B.27—Typical Riprap Slope Protection Detail. The toe should be excavated to a depth of 2.0 feet. The design thickness of the riprap should extend a minimum of 3 feet horizontally from the slope. The finished slope should be free of pockets of small stone or clusters of large stones. Hand placing may be necessary to achieve proper distribution of stone sizes to produce a relatively smooth, uniform surface. The finished grade of the riprap should blend with the surrounding area.

Maintenance

Riprap should be inspected periodically for scour or dislodged stones. Control weed and brush growth as needed.

Figure 5B.26
Angles of Repose of Riprap Stones (FHWA)

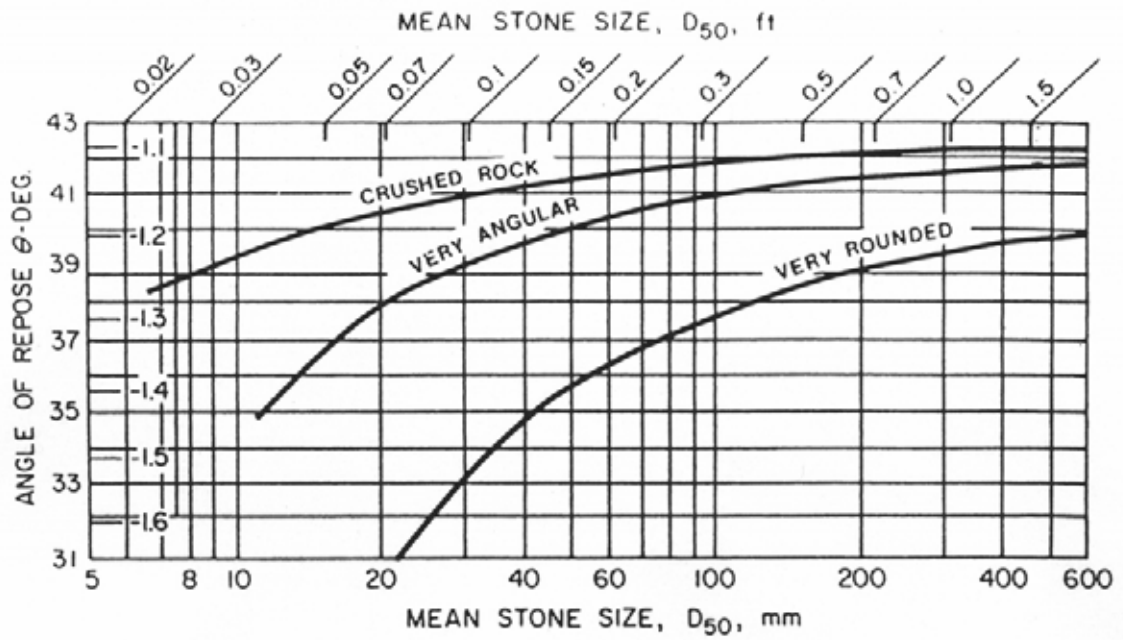
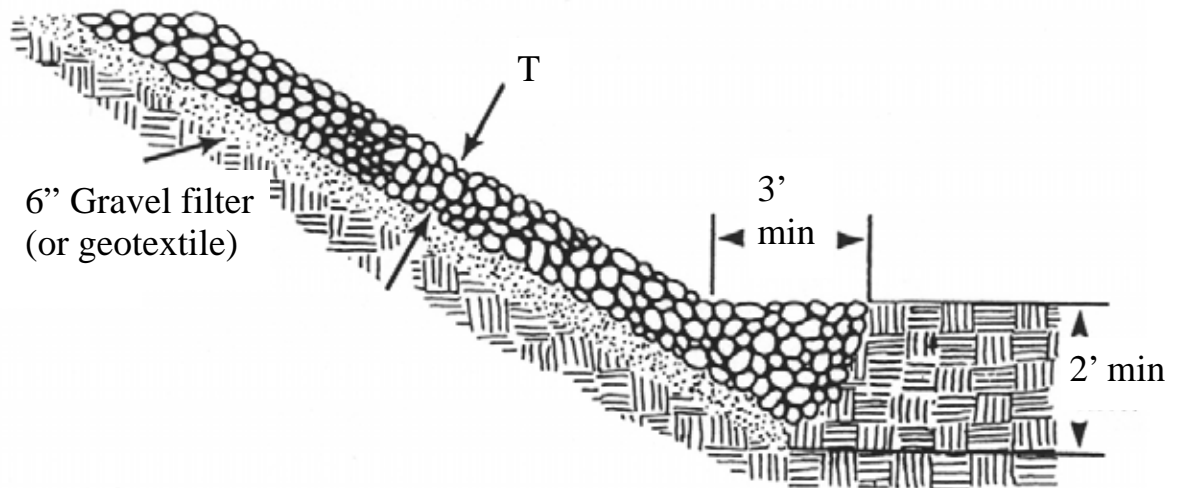

Figure 5B.27
Typical Riprap Slope Protection Detail



STANDARD AND SPECIFICATIONS FOR RETAINING WALLS



Definition

A structural wall constructed and located to prevent soil movement.

Purpose

To retain soil in place and prevent slope failures and movement of material down steep slopes.

Conditions Where Practice Applies

A retaining wall may be used where site constraints will not allow slope shaping and seeding to stabilize an area. Slope areas that demonstrate seepage problems or experience erosive conditions at the toe can utilize retaining walls to help stabilize these areas. Retaining walls can be built from mortared block or stone, cast-in-place concrete, railroad ties, gabions, and more recently, precast concrete modular units and segmented walls that form a gravity retaining wall (see Figure 5B.28 and 5B.29). These precast units allow for ease and quickness of installation while their granular backfill provides drainage. Selection of materials and type of wall should be based on hazard potential, load conditions, soil parameters, groundwater conditions, site constraints, and aesthetics.

Design Criteria

The design of any retaining wall structure must address the aspects of foundation bearing capacity, sliding, overturning, drainage and loading systems. These are complex systems and all but the smallest retaining walls should be designed by a licensed engineer.

Bearing Capacity – A minimum factor of safety of 1.5 should be maintained as the ratio of the ultimate bearing capacity to the designed unit loading. Spread footers and other methods may be used to meet factor requirements.

Sliding – A minimum factor of 2.0 should be maintained against sliding. This factor can be reduced to 1.5 when passive pressures on the front of the wall are ignored.

Overturning – A minimum factor of safety of 1.5 should be used as the ratio of the resisting moment (that which tends to keep the wall in place) to the overturning moment.

Drainage – Unless adequate provisions are made to control both surface and groundwater behind the retaining wall, a substantial increase in active pressures tending to slide or overturn the wall will result. When backfill is sloped down to a retaining wall, surface drainage should be provided. Drainage systems with adequate outlets should be provided behind retaining walls that are placed in cohesive soils. Drains should be graded or protected by filters so soil material will not move through the drainfill.

Load systems – Several different loads or combination of loads need to be considered when designing a retaining wall. The minimum load is the level backfill that the wall is being constructed to retain. Its unit weight will vary depending on its composition.

Additional loads such as line loads, surcharge loads, or slope fills, will add to make the composite design load system for the wall.

Construction Specifications

Concrete Walls

1. Foundation will be prepared by excavating to the lines and grades shown on the drawings and removing all objectionable material.
2. Subgrade will be compacted and kept moist at least 2 hours prior to placement of concrete.
3. Steel reinforcing will be in accordance with the schedule on the drawings and kept free of rust, scale, or dirt.
4. Exposed edges will be chamfered $\frac{3}{4}$ inches.
5. Drainfill will meet the gradations shown on the drawings.

6. Weep holes will be provided as drain outlets as shown on the drawings.
7. Concrete will be poured and cured in accordance with American Concrete Institute (ACI) specifications.

Precast Units

1. Foundation will be prepared by excavating to the lines and grades shown on the drawings.
2. Subgrade will be compacted and trimmed to receive the leveling beam.
3. Precast units will be placed in accordance with the manufacturers recommendation.
4. Granular fill placed in the precast bins shall be placed in 3-foot lifts, leveled off and compacted with a plate vibrator.

Segmented Walls

1. Foundation will be prepared by excavating to the lines and grades shown on the drawings.
2. Sub-grade will be compacted and screeded to form the base for the first course of wall units.
3. Units will be placed in accordance with the manufacturers recommendations, with each succeeding lift anchored and pinned as specified.

4. Granular fill will be placed behind the segmented wall to provide drainage. It shall be compacted with a plate vibrator. A drainage outlet will be provided as specified on the construction drawings.

Gabions

1. Foundation will be prepared by excavating to the lines and grades shown on the drawings.
2. Subgrade will be compacted and leveled to receive first layer of gabions. The first row will be keyed into the existing grade at the toe, a minimum of 1.5 feet.
3. Gabions will be placed according to the manufacturers recommendations.
4. Gabions will be filled with stone or crushed rock from 4 to 8 inches in diameter.
5. In corrosive environments, gabion wire should be coated with Poly Vinyl Chloride (PVC).

Maintenance

Once in place, a retaining wall should require little maintenance. They should be inspected annually for signs of tipping, clogged drains, or soil subsidence. If such conditions exist, they should be corrected immediately.

Figure 5B.28
Retaining Wall Examples

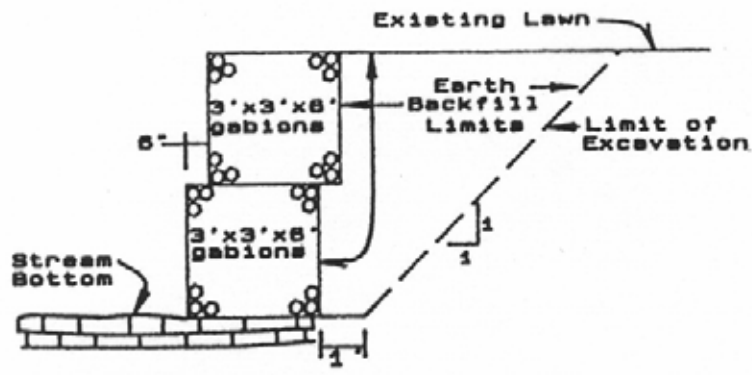
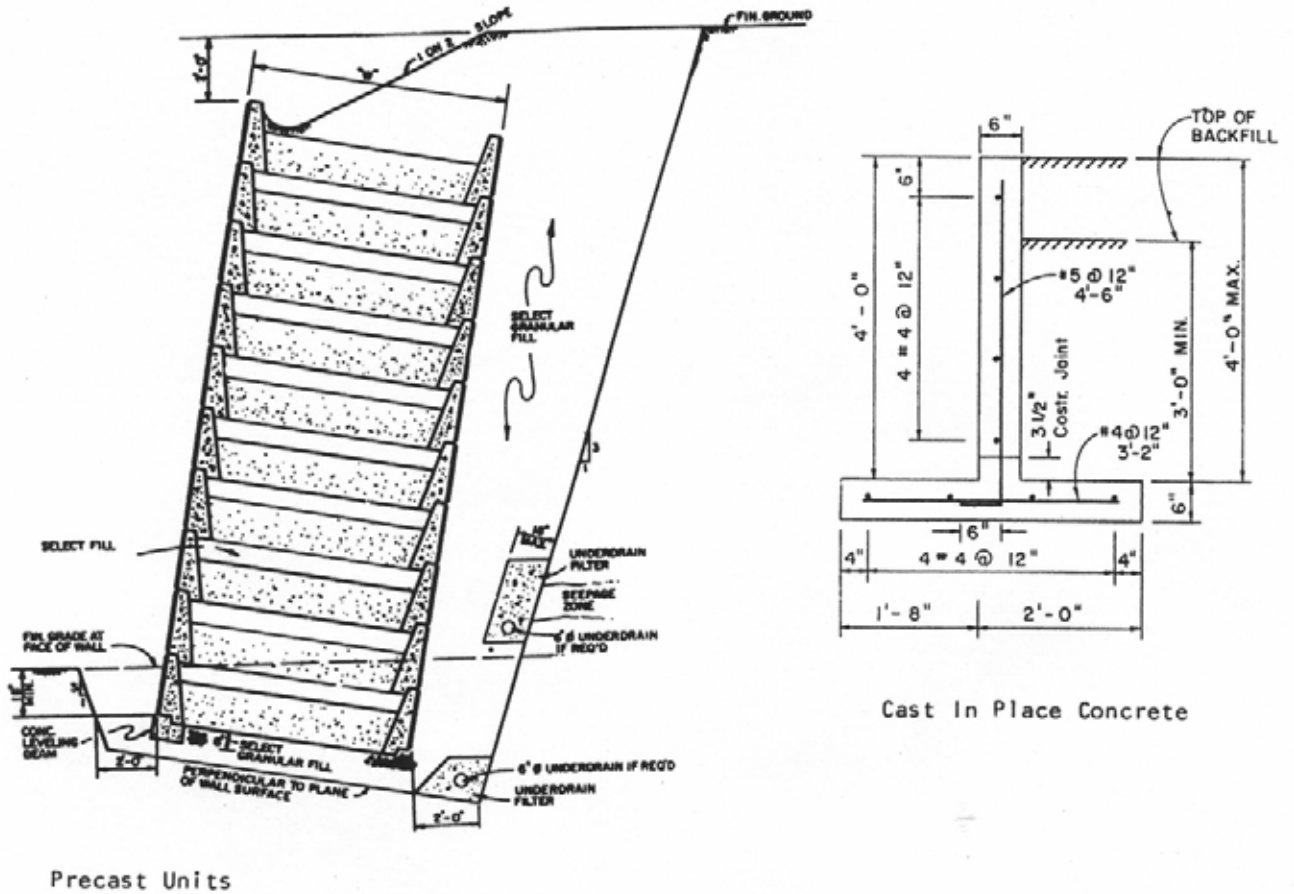

Gabions

Figure 5B.29
Segmented Retaining Wall

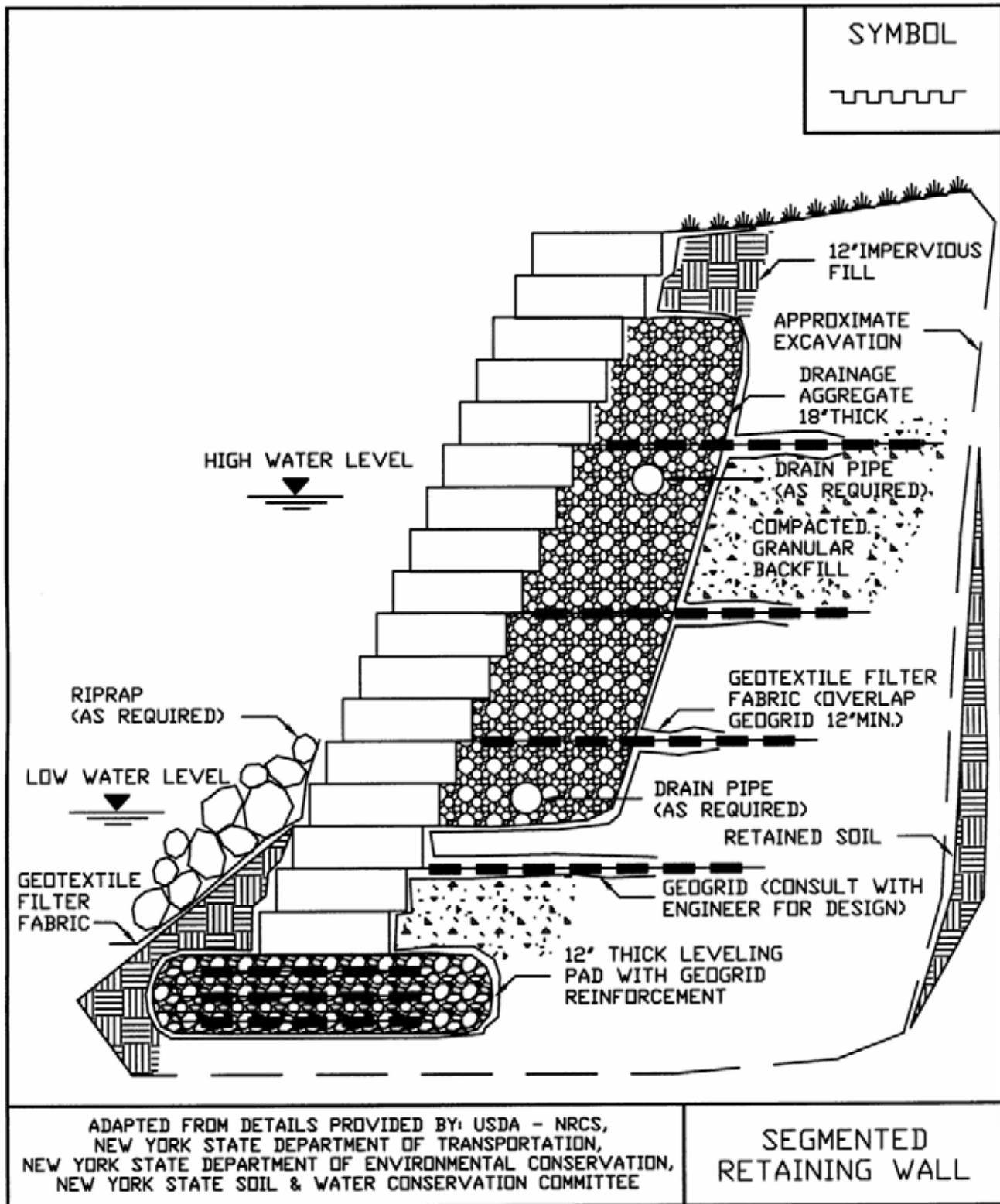

References

1. Natural Resources Conservation Service, USDA. 1992. Engineering Field Handbook. Washington, DC.
2. New York State Department of Transportation. Standards and Specifications. Albany, NY.
3. North Carolina Sedimentation Control Commission. 1998. Erosion and Sediment Control Planning and Design Manual.
4. Schwab, O., et. al. 1955. Soil and Water Conservation Engineering. Glenn John Wiley & Sons, Inc. New York.
5. Soil Conservation Service, USDA. October 1977. National Handbook of Conservation Practices. Washington, DC.
6. Soil Conservation Service, USDA. September 1987. Drainage Guide for New York State. Syracuse, NY.

Page Intentionally Left Blank

<p style="text-align: center;">APPENDIX A REVISED UNIVERSAL SOIL LOSS EQUATION (RUSLE)</p>
--

CONTENTS

	<u>Page</u>
List of Tables	
List of Figures	
Introduction.....	A.1
Why Use RUSLE?.....	A.1
Soil Erosion Estimates Using Revised Universal Soil Loss Equation For Sheet and Rill Erosion.....	A.1
Step-by-Step, How To Use RUSLE.....	A.2
Examples	A.2
References	

Section prepared by:

Frederick B. Gaffney, former Conservation Agronomist
USDA—Natural Resources Conservation Service,
Syracuse, New York

and

Donald W. Lake Jr., P.E., CPESC, CPSWQ
Engineering Specialist
New York State Soil & Water Conservation Committee

List of Tables

<u>Table</u>	<u>Title</u>	<u>Page</u>
A.1	Approximated K Values for Some Representative Soils on Construction Sites in New York.....	A.6
A.2	Values for Topographic Factor, LS, for High Ratio of Rill to Interrill Erosion ¹	A.11
A.3	Factors for Converting Soil Losses (Air-Dry) from Tons (T) to Cubic Yards (Cu. Yds.).....	A.12
A.4	El Values of Certain Key Cities in the New York Area ¹	A.13
A.5	Construction Site Mulching C Factors.....	A.14
A.6	Cover Factor C Values for Different Growth Periods for Planted Cover Crops for Erosion Control at Construction Sites	A.14
A.7	Cover Factor C Values for Established Plants	A.15
A.8	Construction Site P Practice Factors.....	A.15

List of Figures

<u>Figure</u>	<u>Title</u>	<u>Page</u>
A.1	Monthly Percent of Annual Erosion Index—New York.....	A.4
A.2	Monthly Percent of Annual Erosion Index—Long Island.....	A.4
A.3	AVERAGE ANNUAL RAINFALL—RUNOFF EROSIVITY FACTOR (R) for the Northeast....	A.5

REVISED UNIVERSAL SOIL LOSS EQUATION (RUSLE)

Introduction

The science of predicting soil erosion and sediment delivery has continued to be refined to reflect the importance of different factors on soil erosion and runoff. The Revised Universal Soil Loss Equation (RUSLE) has improved the effects of soil roughness and the effects of local weather on the prediction of soil loss and sediment delivery.

The importance of estimating erosion and sediment delivery has long been recognized to minimize pollution by sediments and the chemicals carried by soil particles. The visual effects of erosion include rills and gullies along with sediment blockages found in culverts or drainage ditches. A well planned, engineered and implemented erosion control and/or water management plan will alleviate many concerns about construction site erosion and potential pollution.

Why use RUSLE?

RUSLE is a science-based tool that has been improved over the last several years. RUSLE is a computation method which may be used for site evaluation and planning purposes and to aid in the decision process of selecting erosion control measures. It provides an estimate of the severity of erosion. It will also provide quantifiable results to substantiate the benefits of planned erosion control measures, such as the advantage of adding a diversion ditch or mulch. For example, a diversion may shorten the length of slope used in calculating a LS factor. Also, the application of mulch will break raindrop impact and reduce runoff (See discussion of L,S and C factors).

This section provides a method to calculate soil loss. Following the step-by-step procedure will provide estimated erosion in 'tons per acre per year', which can be converted to the more usable measurement, cubic yards of soil.

Other erosion prediction methods such as computer models are also available. Examples are the USDA-NRCS RUSLE 2 at http://fargo.nserl.purdue.edu/rusle2_dataweb/RUSLE2_Index.htm and USDA-ARS Water Erosion Prediction Project (WEPP) at <http://topsoil.nserl.purdue.edu/nserlweb/weppmain/wpslp.html>

Soil Erosion Estimates Using Revised Universal Soil Loss Equation For Sheet and Rill Erosion

As mentioned above, soil losses on construction sites can be predicted by using the Revised Universal Soil Loss Equation (RUSLE). The equation is as follows:
 $A = RK(LS)$ for bare ground conditions of graded areas of construction sites. Referring to the examples above, the benefit of mulch can be predicted by multiplying the above

by an appropriate cover or C-value. The benefit of a diversion ditch can be illustrated by comparing the original LS with the shorter slope length LS created when adding this practice.

Equation: $A=RK(LS)C P$ Where:

A is the computed soil loss per acre per year in units of tons. This quantity may be converted to cubic yards by using conversion factors shown in Table A.3.

R is the rainfall value reflecting the energy factor multiplied by the intensity factor. The R-values for each county are provided in Figure A.3. EI is the abbreviation for energy and intensity and is called the Erosion Index. The energy component is related to the size of the raindrops while the intensity is the maximum intensity for a 30-minute interval and is measured in inches per hour. EI is frequently illustrated in graphs by showing the percent of EI that occurs within a period of days or months. From the index, one can determine the period when the most intense storms are likely to occur. See Figure A.1 and A.2.

K is the soil erodibility factor. The value for the subsoil condition, usually encountered in construction sites, can be determined based on soil texture (relative percent of sand, silt, and clay) or from most county soil surveys, found in the table providing Physical and Chemical Properties of Soils. However, K values for subsoils are not always available. If the soil survey does not list a subsoil K for the soil series encountered, use the surface K value unless there is an obvious change from sand or gravel to silt or clay. Contact the local SWCD or NRCS office for an appropriate K value when in question. Approximated K values for some representative soils on construction sites in NY can be found in Table A.1.

L is the horizontal length of slope measured in feet. It is the point of origin where water will begin flowing down the slope to the point where concentrated flow begins, such as where water flows into a ditch, or deposition occurs and water disperses. S is the slope gradient. Slopes may be uniform, concave (flattening toward the lower end) or convex (steepening toward the lower end). Table A.2 assumes a uniform slope. If the slope is concave, the LS factor will be slightly lower. If convex, then the LS will be slightly higher. These factors are interrelated and the LS factor can be obtained from Table A.2. This LS table is specific for construction sites with little or no cover.

C is the factor to reflect the planned cover over the soil surface. Most construction sites are void of vegetation and therefore would have a value of one (1). On construction sites where mulch or fabrics are used, the benefit derived from intercepting the erosive raindrop impact on the soil surface is calculated. For example, the value of two tons of straw uniformly covering a slope results in a C-value of 0.1.

(see Tables A.5-A.7 at back of this section) Therefore, mulching can substantially reduce the predicted soil loss.

P is the factor that represents management operations and support practices on a construction site. Table A.8 lists P factors for surface conditions on construction sites in relation to bare soils.

Step-by-Step, How to Use RUSLE

1. Determine the County. Use Figure A.3 to determine the R-value.
2. Determine the soil erodibility factor based on the soil series or the texture. Look up the appropriate K-value for subsoil using Table A.1.
3. Measure the horizontal length (plan view) of slope (in feet) from the top of the slope to the bottom. The bottom is either a ditch bank (concentration of water) or flatter slope where deposition occurs and water disperses (actual field measurement).
4. Determine the percent slope (actual field measurement).
5. Look up LS value in Table A.2. Interpolate if necessary to use the measured length and percent slope obtained by field measurement.
6. Determine the Cover (C) factor—Most construction sites are void of vegetation and therefore would have a value of one (1). For values of other cover conditions, such as straw mulch, contact your local SWCD or NRCS office.
7. Multiply the $R \cdot K \cdot (LS)$ to obtain soil loss in tons/acre/year.
8. Convert to cubic yards if desired. Refer to the conversion factors based on soil texture (Table A.3).
9. Review the examples that follow for specific field conditions where RUSLE may be useful.

Examples

The following are examples showing how the Revised Universal Soil Loss Equation is used for estimating soil losses:

Assume Syracuse, New York, as the locale of a construction site. The disturbed site is 50 acres in size, with an average gradient of 8% and an average slope length of 500 feet. The soil is a Schoharie silt loam with a K value of 0.49 in both the B and C horizons (The K value is obtained from Table A.1). The LS value is 3.11 and is obtained from Table A.2.

1. Compute soil losses from this unprotected surface for a 12 month period. The average annual rainfall erosion index (R) is 80.

$$R = 80 \quad C = 1$$

$$K = 0.49$$

$$LS = 3.11 \text{ (Interpolate between 400' and 600' at 8\%)}$$

$$A = RK(LS)C = 122 \text{ T/ac/yr}$$

$$50 \text{ ac} \times 122 \text{ Tons/ac/yr} = 6100 \text{ Tons/yr}$$

$$\text{Convert to cu yds: } 6100 \text{ T/yr} \times 0.87 \text{ cu yds /Y} = 5307 \text{ cu yds/yr}$$

(0.87 cu yds/T is obtained from Table A.3, silt loam)

2. Compute soil losses from this unprotected surface for a 3 month period (June, July, August). This EI value is obtained as follows: Refer to the erosion index distribution curve applicable to Syracuse, New York, Figure A.1. The EI reading for June 1 is 17% and for September 1 is 76%. The percent of average annual index for this period is 76% - 17% or 59%. Since the annual erosion index for this location is 80, the EI value for the 3 month period is 59% of 80 or 47.2.

$$R = 80 \quad C = 1$$

$$K = 0.49 \quad LS = 3.11$$

$$\text{Annual EI (R)} = 80 \quad \text{3 month EI} = 47.2$$

$$A = (EI)K(LS)C = 72 \text{ Tons/ac/3 mo.}$$

$$50 \text{ ac} \times 72 \text{ Tons/ac/3 mo.} = 3600 \text{ Tons/3 mo.}$$

$$\text{Convert to cu yds: } 0.87 \text{ cu yds/Tons} \times 3600 \text{ Tons/3 mo.} = 3132 \text{ cu yds/3 mo}$$

3. Compute soil losses for the 1 year out of 5 when the rainfall intensity (R) will increase from the normal average annual value of 80 to an annual value of 129 (the latter value is from Table A.4).

$$R = 129 \text{ (Change R from 80 to 129)} \quad K = 0.49$$

$$LS = 3.11 \quad C = 1$$

$$A = RK(LS)C$$

$$A = 129 \times 0.49 \times 3.11 = 197 \text{ Tons/ac/yr}$$

$$50 \text{ ac} \times 197 \text{ Tons/ac/yr} = 9850 \text{ Tons/yr}$$

$$\text{Convert to cu yds} = 0.87 \text{ cu yds/Tons} \times 9850 \text{ Tons/yr} = 8570 \text{ cu yds/yr}$$

4. Compute soil losses for the 1 year out of 20 when the rainfall intensity (R) will increase from the average annual R of 80 to an R of 197 (the latter value is from Table A.4).

$$R = 197 \text{ (Change R from 80 to 197)}$$

$$K = 0.49$$

$$LS = 3.11 \quad C = 1$$

$$A = RK(LS)C = 300 \text{ Tons/ac/yr}$$

$$50 \text{ ac} \times 300 \text{ Tons/ac/yr} = 15,000 \text{ Tons/yr}$$

$$\text{Convert to cu yds} = 0.87 \text{ cu yds/Tons} \times 15,000 \text{ Tons/yr} = 13,050 \text{ cu yds/yr}$$

Examples (continued)

5. Compute soil losses from the expected magnitude of a single storm that may occur once in 5 years. Looking at Table A.4, the expected magnitude, or EI value, is 38.

$$\begin{aligned}EI(R) &= 38 & C &= 1 \\K &= 0.49 \\LS &= 3.11\end{aligned}$$

$$A = (EI)K(LS)C = 38 \times 0.49 \times 3.11 = 58 \text{ Tons/ac/yr}$$

$$50 \text{ ac} \times 58 \text{ Tons/ac/yr} = 2900 \text{ Tons/yr}$$

$$\text{Convert to cu yds} = 0.87 \text{ cu yds/Tons} \times 2900 \text{ Tons/yr} = 2523 \text{ cu yds/yr}$$

6. Compute soil losses from the expected magnitude of a single storm that may occur once in 10 years. The EI value of this storm is 51. (Obtained from Table A.4.)

$$\begin{aligned}EI(R) &= 51 & C &= 1 \\K &= 0.49 \\LS &= 3.11\end{aligned}$$

$$A = (EI)K(LS)C = 78 \text{ Tons/ac/yr}$$

$$50 \text{ ac} \times 78 \text{ Tons/ac/yr} = 3900 \text{ Tons/yr}$$

$$\text{Convert to cu yds} = 0.87 \text{ cu yds/Tons} \times 3900 \text{ Tons/yr} = 3393 \text{ cu yds/yr}$$

7. Compute soil losses from the expected magnitude of a single storm that may occur once in 20 years. The EI value of this storm is 65. (Obtained from Table A.4.)

$$\begin{aligned}EI(R) &= 65 & C &= 1 \\K &= 0.49 \\LS &= 3.11\end{aligned}$$

$$A = (EI)K(LS)C = 99 \text{ Tons/ac/yr}$$

$$50 \text{ ac} \times 99 \text{ Tons/ac/yr} = 4950 \text{ Tons/yr}$$

$$\text{Convert to cu yds} = 0.87 \text{ cu yds} \times 4950 \text{ Tons/yr} = 4307 \text{ cu yds/yr}$$

Sediment Yield—MUSLE

The Modified Universal Soil Loss Equation (MUSLE), developed by Williams and Berndt, 1976, can be used to calculate sediment yields from drainage basins to specific locations for selected storm events.

The formula is given as:

$$T = 95(V \times Q_p)^{0.56} \times K \times LS \times C \times P$$

Where:

T = sediment yield per storm event in tons

V = volume of runoff per storm event in acre-feet

Q_p = peak flow per storm event in cubic feet per second

K, LS, C, and P are RUSLE factors

Values for V and Q_p are determined from the sites drainage analysis.

Example

Compute the sediment yield volume to a basin from a drainage area of 10 acres under construction (all disturbed) for a 2 inch rainfall.

The soil (sandy loam) K = 0.43, LS = 2.34, the volume of runoff is 1.5 acre-feet and the peak discharge for the storm is 5 cubic feet per second.

$$T = 95(1.5 \times 5)^{0.56} (0.43)(2.34)(1)(1)$$

$$T = 295.4 \text{ tons}$$

$$295.4 \text{ tons} \times 0.70 \text{ cy/ton} = 206.99 \text{ cubic yards}$$

Figure A.1 (USDA - NRCS)
Monthly Percent of Annual Erosion Index—New York

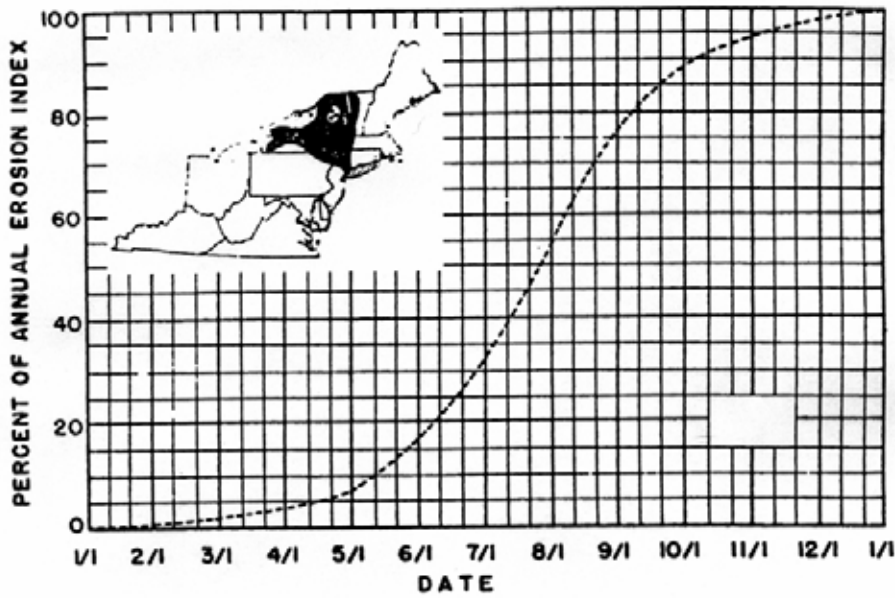

New York State except Long Island

Figure A.2 (USDA - NRCS)
Monthly Percent of Annual Erosion Index—Long Island

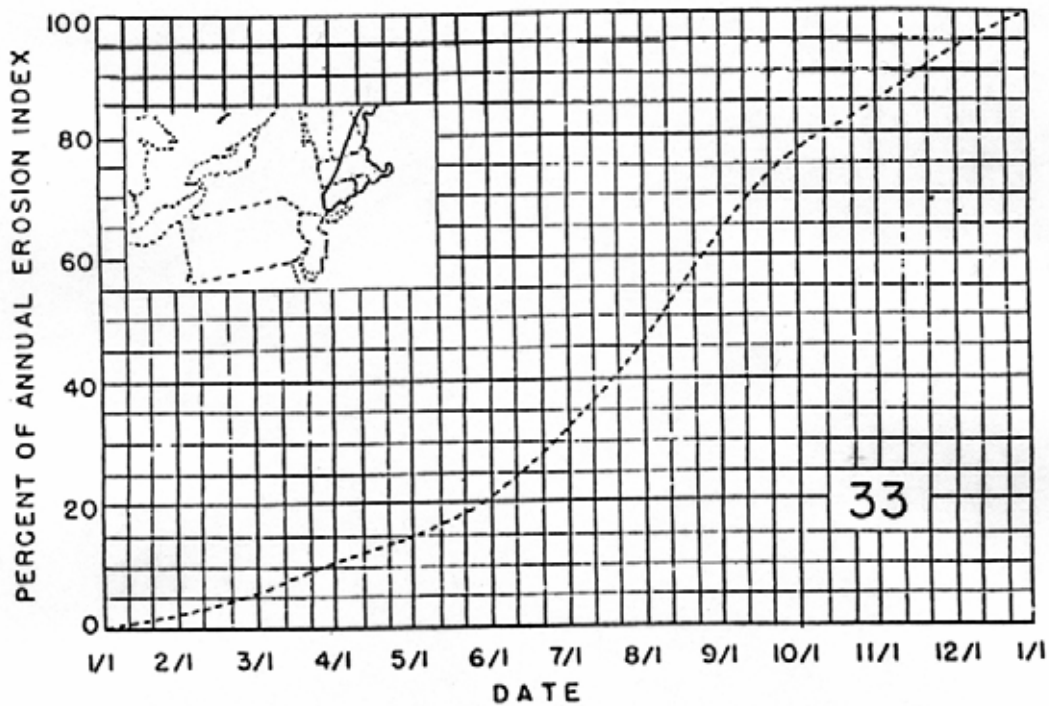

33

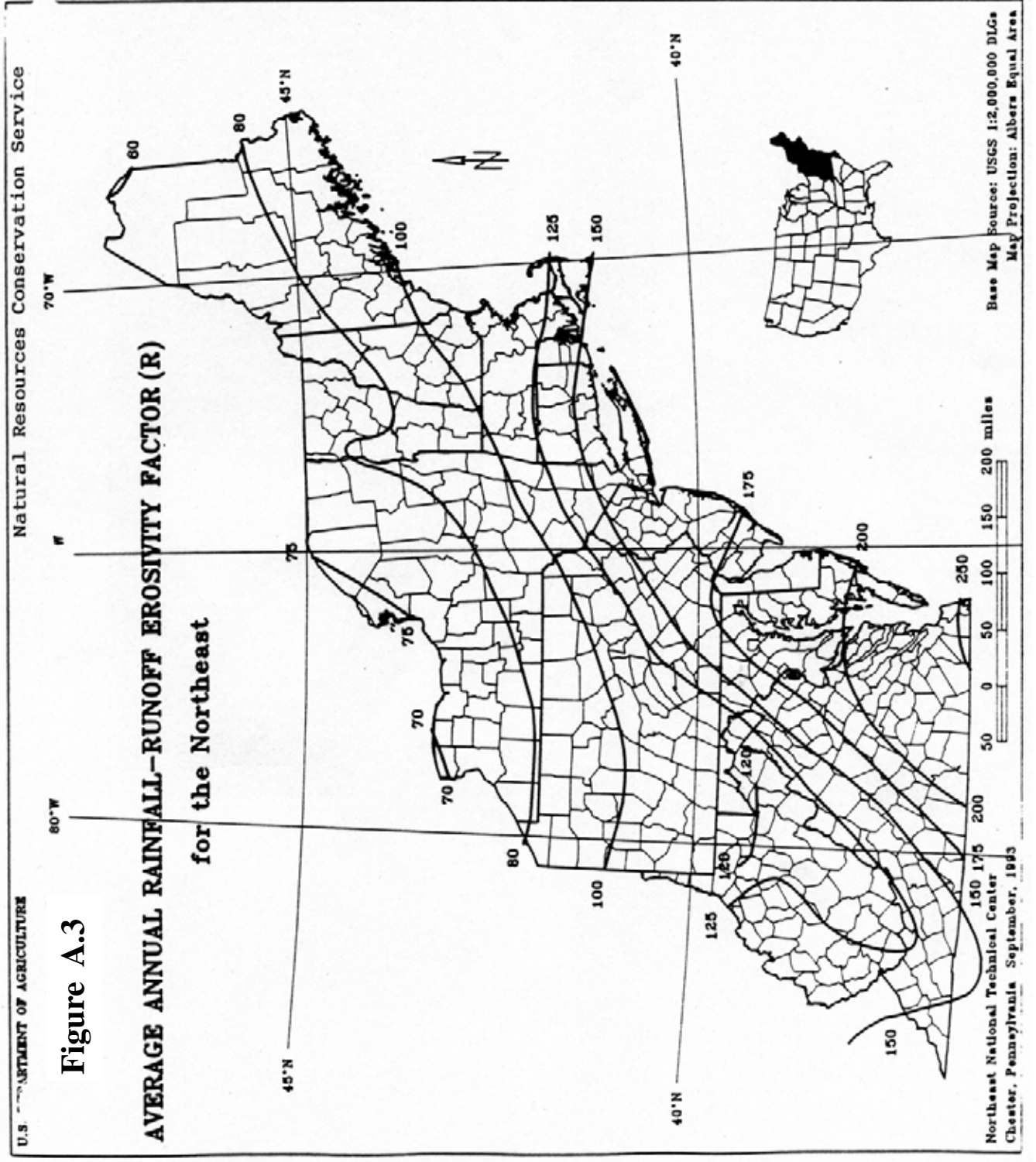

Table A.1

Approximated K Values for Some Representative Soils on Construction Sites in New York

(For soils not in this table, contact the county Soil & Water
Conservation District for appropriate K value.)

Depositional Unit Family Textural Class and Representative Series	Horizon ¹	Texture ²	Class	Construction Site K Values
I. Glacial Till				
SANDY SKELETAL				
Glouster	A	sl	Low	.17
	B & C	vglcs	Low	
SANDY w/PAN				
Essex	A	sl	Low	.20
	B	gls	Low	
	Cx	glcs	Low	
COARSE LOAMY w/PAN				
Empeyville	A	stl	Medium	.17
	B	stsl	Medium	
	Bx	vstsl	Low	
	C	vstsl	Low	
Mardin	A	ch sil	Low	.28
	B	ch sil-1	Medium	
	Bx & C	v ch 1	Medium	
Paxton	A	fsl	Medium	.24
	B	gfsl	Medium	
	Cx	gfsl	High	
Crary	A	sil	Medium	.43
	B	vfsl	High	
	IIBx, Cx, C	st fsl	Medium	
COARSE LOAMY w/Bt				
Madrid	A	fsl	Medium	.28
	Bt	gfsl	Medium	
	C	gfsl	Medium	
COARSE LOAM, 20 TO 40" over BEDROCK				
Lordstown	A	ch sil	Low	.43
	B	ch sil	High	
	C	v ch 1	Low	
	R		Siltstone or sandstone bedrock 20—40" below surface	
FINE LOAMY w/Bt				
Ontario	A	l	Medium	.28
	Bt	gl	Medium	
	C	gl	Medium	

Table A.1 (cont'd)

Approximated K Values for Some Representative Soils on Construction Sites in New York

(For soils not in this table, contact the county Soil & Water
Conservation District for appropriate K value.)

Depositional Unit Family Textural Class and Representative Series	Horizon ¹	Texture ²	Class	Construction Site K Values
I. Glacial Till (cont'd)				
Cazenovia	A	sil	High	.43
	Bt	sicl	High	
	C	gsil	Medium	
Nunda	Ap	ch sil	High	.49
	B2	ch sil	High	
	IIB2t	gcl	Medium	
	IIC	gl	Medium	
FINE Hornell	A	sil	Medium	.43
	B	sic	High	
	C	sh sic	Medium	
	R		Shale bedrock 20—40" below surface	
Remsen	A	sicl	High	.43
	Bt	c	Medium	
	C	c	High	
Churchville	A	sil	High	.49
	Bt	sic	Medium	
	IIC	gl	Medium	
COARSE LOAMY, NO PAN				
Charlton	A	fsl	Low	.43
	B	fsl	High	
	C	gfsl	Medium	
Nellis	A	l	Medium	.43
	B	l	High	
	C	gl	Medium	
Pittsfield	A	l	Medium	.43
	B	gfsl	Low	
	C	gfsl	High	
COARSE LOAMY/SAND or SANDY SKELETAL				
Canton	A	fsl	Medium	.64
	B	fsl	Very High	
	IIC	vgl	Low	
COARSE SILTY w/PAN				
Canaseraga	A	sil	High	.49
	B	sil	Very High	
	IIBx & C	ch	High	

Table A.1 (cont'd)

Approximated K Values for Some Representative Soils on Construction Sites in New York

(For soils not in this table, contact the county Soil & Water
Conservation District for appropriate K value.)

Depositional Unit Family Textural Class and Representative Series	Horizon ¹	Texture ²	Class	Construction Site K Values
I. Glacial Till (cont'd)				
LOAMY SKELETAL				
Manlius	A	ch sil	Medium	.28
	B	vsh sil	Low	
	C	fract'd shales w/ silty fines	Low	
	R		Shale bedrock 20-40" below surface	
FINE LOAMY w/PAN				
Volusia	A	ch sil	Low	.43
	Bx	ch sil	High	
	C	vch l	Medium	
FINE LOAMY, NO PAN				
Kendaia	A	sil	Medium	.28
	B	gsil	Medium	
	C	gl	Medium	
II. Glacial Outwash and Water Worked Morainic Deposits				
SANDY SKELETAL				
Hinckley	A	gls	Low	.17
	B	gls	Low	
	C	gsl	Low	
SANDY				
Colonie	A	lfs	Medium	.24
	B	fs	Low	
	C	fs	Low	
LOAMY SKELETAL				
Chenango	A	gl	Low	.24
	B	vgl	Low	
	C	gls	Low	
FINE LOAMY/SANDY or SANDY SKELETAL				
Palmyra	A	gl	Low	.28
	B	gl	Medium	
	IIC	g & s	Low	
LOAMY SKELETAL/CLAYEY				
Varysburg	A	gl	Low	.28
	B2t	vgl	Low	
	IIB2t	sic	Medium	
	IIC	layered sic, sil sicl	High	

Table A.1 (cont'd)
Approximated K Values for Some Representative Soils on
Construction Sites in New York

(For soils not in this table, contact the county Soil & Water
Conservation District for appropriate K value.)

Depositional Unit Family Textural Class and Representative Series	Horizon ¹	Texture ²	Class	Construction Site K Values
II. Glacial Outwash and Water Worked Morainic Deposits (cont'd)				
COARSE LOAMY Riverhead	A	sl	Low	.17
	B	sl	Low	
	C	s w/ thin layers of g	Low	
COARSE LOAMY/SANDY or SANDY SKELETAL Haven	A	l	High	.43
	B	l	High	
	IIC	gs	Low	
III. Lacustrine or Stream Terrace Deposits				
COARSE SILTY Unadilla	A	sil	High	.64
	B	sil	Very High	
	C	sil	Very High	
COARSE SILTY w/FRAGIPAN Williamson	A	sil	High	.64
	Bx	sil	Very High	
	C	sil	Very High	
COARSE SILTY/SANDY or SANDY SKELETAL Allard	A	sil	High	.64
	B	sil	Very High	
	IIC	vgls	Low	
FINE SILTY w/Bt Collamer	A	sil	High	.64
	Bt	sil	High	
	C	Layers of sl, vfs	Very High	
FINE Schoharie	A	sicl	High	.49
	Bt	sic	Medium	
	C	sic	High	
VERY FINE Vergennes	A	c	High	.49
	Bt	c	Low	
	C	c	Low	

Table A.1 (cont'd)

Approximated K Values for Some Representative Soils on Construction Sites in New York

(For soils not in this table, contact the county Soil & Water Conservation District for appropriate K value.)

Depositional Unit Family Textural Class and Representative Series	Horizon ¹	Texture ²	Class	Construction Site K Values
III. Lacustrine or Stream Terrace Deposits (cont'd)				
SANDY o/CLAYEY Claverack	A	lfs	Medium	
	B	lfs	Low	
	IIC	sic	High	0.43
	R			
COARSE LOAMY o/CLAYEY Elmwood	A	fsl	Medium	
	B	sl	Low	
	C	sicl	High	0.43

1 The thickest B and C horizons in the official series were used in making the K value determinations.

2 Soil texture abbreviations:

Gravel.....g	Fine sandy loam.....fsl	Sandy clay loam.....scl
Very coarse sand.....vcos	Very fine sandy loam...vfsl	Stoney clay loam.....stcl
Coarse sand.....cos	Gravelly sandy loam....gs	Silty clay.....sic
Sand.....s	Loam.....g	Clay.....c
Fine sand.....fs	Gravelly loam.....gl	Channery.....ch
Very fine sand.....vfs	Stoney loam.....stl	Shaly.....sh
Loamy coarse sand.....lcos	Silt.....si	Very channery.....vch
Loamy sand.....ls	Silt loam.....sil	Very shaly.....vsh
Loamy fine sand.....lfs	Clay loam.....cl	Sandy loam.....sl
Silty clay loam.....sisl		

Table A.2 (USDA - NRCS)
Values for Topographic Factor, LS,
for High Ratio of Rill to Interrill Erosion¹

Slope (%)	Horizontal slope length (ft)																
	<3	6	9	12	15	25	50	75	100	150	200	250	300	400	600	800	1000
0.2	0.05	0.05	0.05	0.05	0.05	0.05	0.05	0.05	0.05	0.05	0.06	0.06	0.06	0.06	0.06	0.06	0.06
0.5	0.07	0.07	0.07	0.07	0.07	0.07	0.08	0.08	0.08	0.09	0.09	0.10	0.10	0.11	0.12	0.12	0.13
1.0	0.09	0.09	0.09	0.09	0.09	0.10	0.10	0.10	0.11	0.11	0.12	0.12	0.13	0.13	0.14	0.14	0.15
2.0	0.13	0.13	0.13	0.13	0.13	0.14	0.14	0.14	0.15	0.15	0.16	0.16	0.17	0.17	0.18	0.18	0.19
3.0	0.17	0.17	0.17	0.17	0.17	0.18	0.18	0.18	0.19	0.19	0.20	0.20	0.21	0.21	0.22	0.22	0.23
4.0	0.20	0.20	0.20	0.20	0.20	0.21	0.21	0.21	0.22	0.22	0.23	0.23	0.24	0.24	0.25	0.25	0.26
5.0	0.23	0.23	0.23	0.23	0.23	0.24	0.24	0.24	0.25	0.25	0.26	0.26	0.27	0.27	0.28	0.28	0.29
6.0	0.26	0.26	0.26	0.26	0.26	0.27	0.27	0.27	0.28	0.28	0.29	0.29	0.30	0.30	0.31	0.31	0.32
8.0	0.32	0.32	0.32	0.32	0.32	0.33	0.33	0.33	0.34	0.34	0.35	0.35	0.36	0.36	0.37	0.37	0.38
10.0	0.35	0.35	0.35	0.35	0.35	0.36	0.36	0.36	0.37	0.37	0.38	0.38	0.39	0.39	0.40	0.40	0.41
12.0	0.38	0.38	0.38	0.38	0.38	0.39	0.39	0.39	0.40	0.40	0.41	0.41	0.42	0.42	0.43	0.43	0.44
14.0	0.38	0.45	0.51	0.55	0.58	0.62	0.65	0.68	0.71	0.74	0.77	0.80	0.83	0.86	0.89	0.92	0.95
16.0	0.39	0.49	0.56	0.62	0.67	0.72	0.76	0.80	0.84	0.88	0.92	0.96	1.00	1.04	1.08	1.12	1.16
20.0	0.41	0.56	0.67	0.76	0.84	0.93	1.04	1.15	1.24	1.33	1.42	1.51	1.60	1.69	1.78	1.87	1.96
25.0	0.45	0.64	0.80	0.93	1.04	1.16	1.28	1.40	1.51	1.62	1.73	1.84	1.95	2.06	2.17	2.28	2.39
30.0	0.48	0.72	0.91	1.06	1.24	1.44	1.66	1.88	2.10	2.32	2.54	2.76	2.98	3.20	3.42	3.64	3.86
40.0	0.53	0.85	1.13	1.37	1.59	1.81	2.03	2.25	2.47	2.69	2.91	3.13	3.35	3.57	3.79	4.01	4.23
50.0	0.58	0.97	1.31	1.62	1.91	2.20	2.49	2.78	3.07	3.36	3.65	3.94	4.23	4.52	4.81	5.10	5.39
60.0	0.63	1.07	1.47	1.84	2.19	2.54	2.89	3.24	3.59	3.94	4.29	4.64	4.99	5.34	5.69	6.04	6.39

¹Such as for freshly prepared construction and other highly disturbed soil conditions with little or no cover (not applicable to thawing soil)

Table A.3 (USDA - NRCS)
Factors for Converting Soil Losses (Air-Dry)
from Tons (T) to Cubic Yards (Cu. Yds.)

Sands, loamy sands)
Sandy loam) - Multiply soil losses in T by 0.70 (105) ¹
Fine sandy loam)
Loams, sandy clay loams)
Sandy clay) - Multiply soil losses in T by 0.87 (85)
Silt loam)
Silty clay loam, silty clay)
Clay loam) - Multiply soil losses in T by 1.06 (70)
Clay)

¹The number in parentheses is the air-dry weight of the soil in pounds per cubic foot. The conversion factors were calculated from these air-dry weights using: soil loss (tons) x (2000 lbs/ton) x (ft³/dry density lbs) x (cubic yard/27ft³).

Table A.4
EI Values of Certain Key Cities in the New York Area¹

<u>Location</u> ²	<u>EI Values at 20% and 5% Probability Levels Probability (EI)</u>		<u>Expected Magnitude of a Single Storm EI Value Normally Exceeded Once in—</u>		
	<u>20%*</u>	<u>5%**</u>	<u>5 Years</u>	<u>10 Years</u>	<u>20 Years</u>
New York					
Albany	114	159	38	47	56
Binghamton	106	146	36	47	58
Buffalo	96	139	36	49	61
Geneva	106	152	—	—	—
Marcellus	112	167	38	49	62
Rochester	101	151	38	54	75
Salamanca	106	157	32	40	49
Syracuse	129	197	38	51	65
Pennsylvania					
Erie	181	331	—	—	—
Scranton	140	188	44	53	63
Vermont					
Burlington	114	178	35	47	58
Connecticut					
New Haven	222	310	73	96	122
New Jersey					
Atlantic City	229	311	77	97	117
Marlboro	254	343	85	111	136
Trenton	216	308	76	102	131

* Once each five years

** Once each twenty years

¹ From Agricultural Handbook No. 537

² For additional cities, refer to Agricultural Handbook 537, Tables 17 & 18.

Table A.5
Construction Site Mulching C Factors
(Data from Wischmeier and Smith 1978, Pitt 2004)

Type of Mulch	Mulch Rate (tons per acre)	Land Slope (%)	Mulching C Factor	Length Limit (ft) ¹
None	0	all	1.0	n/a
Straw or hay, tied down by anchoring and tacking equipment	1.0	1-5	0.20	200
	1.0	6-10	0.20	100
	1.5	1-5	0.12	300
	1.5	6-10	0.12	150
	2.0	1-5	0.06	400
	2.0	6-10	0.06	200
	2.0	11-15	0.07	150
	2.0	16-20	0.11	100
	2.0	21-25	0.14	75
	2.0	26-33	0.17	50
	2.0	34-50	0.20	35
Wood Chips	7	<16	0.08	75
	7	16-20	0.08	50
	12	<16	0.05	150
	12	16-20	0.05	100
	12	21-33	0.05	75
	25	<16	0.02	200
	25	16-20	0.02	150
	25	21-33	0.02	100
	25	34-50	0.02	75

¹ Maximum slope lengths for which the specified mulch rate is considered effective. If these limits are exceeded, either a higher application rate or mechanical shortening of the effective slope length is required (such as with terracing).

Table A.6
Cover Factor C Values for Different Growth Periods for Planted Cover Crops for Erosion Control at Construction Sites
(Data from Wischmeier and Smith 1978, Pitt 2004)

	SB (seedbed preparation)	Period 1 (establishment)	Period 2 (development)	Period 3a (maturing crop)	Period 3b (maturing crop)	Period 3c (maturing crop)
Crop Canopy ¹	0-10%	10-50%	50-75%	75-80%	75-90%	75-96%
Seeding on topsoil, without mulch	0.79	0.62	0.42	0.17	0.11	0.06
Seeding on a desurfaced area, where residual effects of prior vegetation are no longer significant	1.0	0.75	0.50	0.17	0.11	0.06
Sod	0.01	0.01	0.01	0.01	0.01	0.01

¹ Percent canopy cover is the percentage of the land surface that would not be hit by directly falling rain drops because the drops would be intercepted by the plant. It is the portion of the soil surface that would be covered by shadows if the sun were directly overhead.

Table A.7
Cover Factor C Values for Established Plants
 (data from NRCS NEH Chapter 3 and Wischmeier and Smith 1978)

Percentage of surface covered by residue in contact with the soil								
	Percent Cover ¹	Plant Type	0%	20	40	60	80	95+
C factor for grass, grasslike plants, or decaying compacted plant litter	0	Grass	0.45	0.20	0.10	0.042	0.013	0.0003
C factor for broadleaf herbaceous plants (including most weeds with little lateral root networks), or undecayed residues	0	Weeds	0.45	0.24	0.15	0.091	0.043	0.011
Tall weeds or short brush with average drop height ² of =20 inches	25	Grass	0.36	0.17	0.09	0.038	0.013	0.003
		Weeds	0.36	0.20	0.13	0.083	0.041	0.011
	50	Grass	0.26	0.13	0.07	0.035	0.012	0.003
		Weeds	0.26	0.16	0.11	0.076	0.039	0.011
	75	Grass	0.17	0.12	0.09	0.068	0.038	0.011
		Weeds	0.17	0.12	0.09	0.068	0.038	0.011
Mechanically prepared sites, with no live vegetation and no topsoil, and no litter mixed in.	0	None	0.94	0.44	0.30	0.20	0.10	Not given

¹ Percent cover is the portion of the total area surface that would be hidden from view by canopy if looking straight downward.

² Drop height is the average fall height of water drops falling from the canopy to the ground.

Table A.8 (USDA-NRCS)
Construction Site P Practice Factors

Surface Condition		P Factor
Bare Soil Loose		1.0
Freshly disked or rough irregular surface		0.9
Compact smooth by equipment up and down hill		1.3
Compact smooth by equipment across slope		1.2
Contoured Furrows:		
Slope (%)	Maximum Downslope Length (ft)	P Factor
1-2	350	0.6
3-5	250	0.5
6-8	200	0.5
9-12	125	0.6
13-16	75	0.7
17-20	60	0.8
>20	50	0.8

Source: USDA-NRCS; HDI, 1987; Wischmeier and Smith, 1978

References

1. Predicting Soil Erosion by Water: A Guide to Conservation Planning With the Revised Universal Soil Loss Equation (RUSLE). USDA-Agricultural Research Service Agric. Hdbk. No. 703. Renard, K.G., G. R. Foster, G.A. Weesies, D.K. McCool, and D.C. Yoder. 1997.
2. (data from Wischmeier and Smith 1978)
3. Construction Site Erosion and Sediment Controls: Planning, Design and Performance. R. Pitt, S. Clark, and D. Luke. 2004.

APPENDIX B

PERFORMANCE EVALUATION FOR TEMPORARY EROSION AND SEDIMENT CONTROL PRACTICES

Background

Standard details and drawings for temporary erosion and sediment control practices have been used since the early 1970's. Many of these details were developed by the United States Department of Agriculture (USDA) Soil Conservation Service (SCS), now known as the Natural Resources Conservation Service (NRCS). These details were incorporated into many state design manuals. These practices included the following:

- Earth Dike
- Temporary Swale
- Perimeter Dike/Swale
- Level Spreader
- Pipe Slope Drain
- Straw Bale Dike
- Silt Fence

What made the use of these details attractive was that they were sized based upon the drainage area, and no extensive engineering calculations were needed for design. For example, if we needed to design a temporary swale to control the runoff from 8 acres above a disturbed construction area by sloping the swale at 3 percent, we would look at page 7A.3 and select Swale B, with a channel treatment of seed and straw mulch. The Swale B cross section is a 6-foot bottom width, 1-foot design depth, and 2:1 side slopes.

This selection process is independent of location in New York State as well as the design rainfall amount. As a result, individuals have often wondered what level of protection is actually being provided.

Site specific practice design depends on a number of variables. These include drainage area, hydrologic soil group, cover, topography, rainfall amount, and intensity or distribution. The following evaluation procedure can be used to incorporate these variables into the practice design. The procedure can also be used to design temporary practices for site specific storm events.

Conveyance Evaluation Procedure

This method of evaluating the performance of a practice is applicable to most of the temporary practices. The first example evaluates the effectiveness of the temporary swale.

CASE 1—Swale A, Average Conditions

Given:

Drainage Area = 4.9 acres

Hydrologic Soil Group = C

Runoff Curve Number = 91
(C soil disturbed for construction)

Slope of Swale = 3%

Rainfall (P) = 2.5 inches
(This represents NY state's average 1-year, 24-hour storm)

Runoff (Q) = 1.6 inches

Time of Concentration for Runoff (T_c) = 6 minutes
(assumed 0.1 hour, the shortest allowed with TR-55)

From Section 4, TR-55 Graphical Method, where:

I_a = Initial Abstraction = 0.198"

Q_{in} = Runoff in inches

q_u = Unit peak discharge in cubic feet per second per square mile

A_m = Drainage area in square miles

F_p = Pond and swamp factor

Drainage Area = $4.9/640 = 0.00766$ sq. mi.

if P = 2.5 inches, then $I_a/P = 0.00$, use 0.1

$Q_{in} = 1.6$

Then, from Figure 4.15 (Type 2), $q_u = 1,000$ cs/mlin

from Equation 4.8 $q_p = (q_u)(A_m)(Q)(F_p)$

Therefore, $q_p = (1,000)(.00766)(1.6)$

$q_p = 12.2$ cfs

For Swale A, the design cross-section shows a bottom width of 4 feet., design depth of 1 foot, and 2:1 side slopes.

Therefore, swale area = 6 ft^2 for design depth

Compute velocity, $V = \frac{1.486}{n} \left(\frac{A}{W_p} \right)^{2/3} S^{1/2}$

Where

$n = .040$ for vegetated channels

A = 6 sq. ft.
 Wp = 8.2 ft. (wetted perimeter)
 S = .03 ft/ft (slope)

$$\text{Therefore, } V = \frac{1.486}{.04} \left(\frac{6}{8.2} \right)^{2/3} (.03)^{1/2}$$

$$= 5 \text{ feet per second}$$

Since $Q = AV$, the swale capacity is

$$Q = (6 \text{ ft}^2)(5 \text{ ft/sec}) = 30 \text{ cfs or more than twice required}$$

CASE 2—Swale B, Average Conditions

Given:

Drainage Area = 10 acres
 Hydrologic Soil Group = C
 Runoff Curve Number = 91, therefore $I_a = 0.198"$
 Slope of Swale = 3%
 Rainfall (P) = 2.5 inches
 Runoff (Q) = 1.6 inches
 Time of Concentration for Runoff (T_c) = 0.1

Similarly to Case 1, $q_u = 1,000$ CSM

$$A_m = 10/640 = 0.01563$$

$$q_p = (1,000)(.01563)(1.6) = 25 \text{ cfs}$$

For Swale B, the design cross-section has a 6-foot bottom width, 1-foot depth, and 2:1 side slopes.

$$\text{Therefore, the area} = 8 \text{ ft}^2$$

Computing velocity for a swale slope of 3%,

$$V = \frac{1.486}{.04} \left(\frac{8}{10.47} \right)^{2/3} (.03)^{1/2}$$

$$V = (37.15)(.836)(.173) = 5.37 \text{ ft/sec}$$

Since $Q = AV$, the swale capacity is

$$Q = (8 \text{ ft}^2)(5.37 \text{ ft/sec}) = 43 \text{ cfs}$$

CASE 3—This site is adjacent to a significant water body in Westchester County. We want to protect the site for the 2-year, 24-hour storm.

Given:

Drainage Area = 10 acres
 Hydrologic Soil Group = D soils
 Runoff Curve Number = 94, ("D" under construction)
 Slope of Swale = 3%
 Rainfall (P) = 3.5 inches; $I_a = 0.128"$
 Runoff (Q) = 2.8 inches; Type 3 rainfall
 Assume Time of Concentration for Runoff (T_c) = 0.1 hour (most conservative value)

$$A_m = 10/640 = 0.01563 \text{ sq. mi.}$$

$$I_a/P = 0.128/3.5 = 0.04, \text{ therefore use } 0.1$$

From Figure 4.16 (Type 3), $q_u = 655$ CSM

$$\text{Therefore, } qp = (655)(0.01563)(2.8)$$

$$= 28.7 \text{ cfs}$$

From CASE 2, Swale B, we know that the maximum capacity is 43 cfs with a velocity of 5.37 feet per second.

Our conclusions would indicate that Swale B is adequate for capacity. The velocity is higher and thus a mulch lining should be used to protect the swale from erosion.

Storage Evaluation Procedure

Practices such as silt fence, straw bale dikes, and earthen berms are often used on slopes or near the toes of fill slopes to capture sediment laden runoff. These have failed many times in the field due to poor siting, improper installation, lack of maintenance, and little consideration of the proper use of the practice.

As an example of how careful we need to be in using these practices, look at the use of silt fence in the following typical situations.

CASE 1—At the toe of a 3:1 earthfill

Given: 30' high earthfill
Hydrologic Soil Group—C
Therefore, Runoff Curve Number = 91

Typically, the installed height of the silt fence is 30-36".
The maximum design sediment depth behind the silt fence is 50% of its height, or 18" maximum.

For this case, the design sediment area is equal to:

$$A = 1/2bh$$

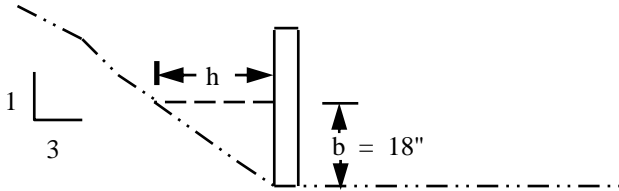

$$A = 1/2 (1.5')(4-5') = 3.375 \text{ sq. ft. per linear foot}$$

This equals 337.5 cubic feet per 100 feet of fence.

The actual slope surface is approximately 95 feet. For a rainfall of 1 inch on this site, the runoff equals 0.4 inches.
The total volume of runoff would equal

$$\frac{0.4 \text{ inches}}{12 \text{ inches/ft}} \times 9500 \text{ sq. ft.} = 317 \text{ cu. ft.}$$

This example shows that the volume required for a 1-inch storm is barely provided, but the location of the fence provides no buffer for material that rolls down the slope nor room for maintenance. The fence should be located at least 10 feet from the toe of the slope.

CASE 2—Determine level of protection for CASE 1 when fence is moved 10 feet from the toe of slope.

When the silt fence is moved 10' away from the 3:1 slope, the design area of storage equals,

$$337.5 \text{ sq. ft.} + 1,500 \text{ sq. ft.} = 1,837.5 \text{ cu.ft. per 100 feet of fence}$$

Since this is the maximum runoff volume that can be controlled, the runoff depth is,

$$\frac{1,837.5 \text{ ft}^3}{9,500 \text{ ft}^2} = 0.193 \text{ feet} = 2.3 \text{ inches}$$

From Section 4, Figure 4.1 for a Q = 2.3 inches, and a Curve Number at 91, P is interpreted at 3.2 inches.

Thus, this design configuration can manage to store the runoff from a 3.2 inch rainfall event.

This method can be used to evaluate the positioning of these sediment control practices on the contour to hold sediment close to its source. It allows a designer to evaluate an existing condition, or to select a specific level of protection higher than that which may be provided by the standard details.

Page Intentionally Left Blank

APPENDIX C
COST ANALYSIS OF
EROSION AND SEDIMENT CONTROL PRACTICES

CONTENTS

	<u>Page</u>
List of Tables	
Analyzing Benefits and Costs.....	C.1
Ascribing Effects to Treatment Measures.....	C.1
Pricing Treatment Measures and Benefits.....	C.1
Period of Analysis and Evaluation.....	C.1
Appraisal of Damages and Treatment Costs.....	C.1
Treatment Measures.....	C.1
Benefit-Cost Analysis.....	C.2
Example.....	C.2
Cost Estimate—SITE EXAMPLE.....	C.5
References	

Section prepared by:

Donald W. Lake Jr., P.E., CPESC, CPSWQ
Engineering Specialist
New York State Soil & Water Conservation Committee

List of Tables

<u>Table</u>	<u>Title</u>	<u>Page</u>
C.1	Cost Table.....	C.3
C.2	Annual Maintenance Cost As Percentage of Installation Cost.....	C.4
C.3	Cost Estimate—SITE EXAMPLE.....	C.5

COST ANALYSIS OF EROSION AND SEDIMENT CONTROL PRACTICES

Analyzing Benefits and Costs

Benefit-Cost analysis is a technique used to determine whether a measure will result in more benefits than it will cost.

For the purposes of making a benefit-cost analysis for erosion and sediment control, the time period associated with erosion and sedimentation is considered to extend from the first disturbance of the land to the time of establishing effective erosion control.

Ascribing Effects to Treatment Measures

The generally accepted basis for attributing effects of treatment measures on a comparable basis is the “with” and “without” approach. This approach compares the expected difference in damages between what is expected if no control is used and what is expected if a measure is installed. The total difference in expected damage is the estimated benefit of the measure.

Sediment damages may be related to (1) deposition of eroded materials on flood plains, in channels, reservoirs, residences, utilities, and other properties that require the removal and disposition of materials, and the repairing of damaged facilities and (2) swamping damage which adversely affects existing features or limits potential improvement of land caused by a rise in the ground water table or by impairing surface drainage.

Sediment resulting from construction sites can be deposited along a stream and cause individual landowners to pay for its removal. Sediment can also destroy aesthetic values of a stream (clean water vs. turbid water) and adversely impact stream fisheries and micro-organisms.

In municipal and industrial uses where water is pumped directly from a river or reservoir, slugs of sediment associated with excessive rainfall may pose severe water quality problems. Turbidity may be increased, necessitating increased treatment, which raises the cost of operations. Sediment may also be deposited in storm drains, reducing their ability to control flooding. This increases flood damage and requires the cleanout of sediment from the storm drain systems.

Pricing Treatment Measures and Benefits

Prices applied should reflect values expected to prevail at the time of occurrence. Current prices are used for installation costs of treatment measures. Projected

normalized prices (based on past prices and trends) should be used for estimating future values (benefits, operations and maintenance costs and replacement costs) for permanent type measures only.

Period of Analysis and Evaluation

The period of analysis in years should equal the economic life (need for a measure) or the physical life of treatment measures, whichever is less. The benefits considered over the evaluation period include those accruing over the period.

The annual costs of permanent measures chargeable to the evaluation period include the amortized installation cost and the future annual operation, maintenance, and replacement cost necessary to provide the benefits over the evaluation period. The amortization rate should be based on prevailing local interest rates at the time of installation.

Appraisal of Damages and Treatment Costs

Many people are affected by the damages resulting from erosion and sedimentation. Also, communities and individuals benefit from its prevention, reduction, or mitigation.

Costs will be incurred to: (1) install remedial treatment measures; or (2) correct damages; or (3) a combination of the two.

Treatment Measures

Treatment measures on developing sites are frequently temporary—generally lasting only one or two construction seasons. Benefits and cost for temporary measures can be compared directly using current prices.

Permanent measures are planned to trap sediment and control erosion and runoff during and beyond the construction period. The prevention of sediment damages can be accomplished by either, or both of, two methods:

1. Stabilizing sediment source areas by applying conservation erosion control measures.
2. Trapping sediment before it leaves the construction area (sediment control)

(Erosion control is often more effective than sediment control at preventing sediment damage. It is highly recommended to use both methods to maximize benefits.)

Some of the potential benefits from preventing downstream sediment transport and deposition include:

1. Prevention or reduction in cost of removal and disposition of sediment from properties.
2. Prevention or reduction in damage to property.
3. Prevention of water quality impairment.

Some permanent measures may be retained to provide long-term benefits.

For example, a sediment basin may be cleaned out after construction is finished and utilized for aesthetics, recreation, fish, or stormwater management.

Benefits and costs for permanent measures need to be converted by discounting and amortizing to average annual figures for comparison.

Benefit-Cost Analysis

A simple equation for determining the benefits of controlling sediment is:

$$B = (SxY) - [C + (SxY)(1.00-P)]$$

Where: B = Benefits in dollars.

S = Cubic yards of sediment expected to move off the site if no control measures are applied. (See Section 3).

Y = Cost in dollars per yard to recover and dispose of sediment that has moved off the site.

C = Estimated cost of temporary measures to be installed. (See Cost Tables).

P = Estimated effectiveness of proposed measures expressed as a decimal.

Example

This example illustrates the methodology of a benefit-cost analysis:

Given: A construction site of 78 acres, which without erosion or sediment control measures will yield about 5 acre feet or 8,000 cubic yards of sediment (S) to the lower end of the site. There is a channel with several culverts located below the site and it is assumed all the sediment would be deposited in it. It would be necessary to remove all the additional sediment in order to maintain the capacity of the channel and avoid increased hazard to flooding. The cost of removing and disposing the sediment is estimated at \$2.00 per cubic yard (Y).

With temporary erosion and sediment control measures, including a sediment basin, in place during the one year

construction period, sediment delivered to the channel will be reduced 90 percent (P). The cost of the measures would be as follows, (no amortization is required since costs and benefits are incurred in a similar one year period):

1. Land grading measures.....\$2,000
2. Temporary sediment basin.....\$3,000
 - a. Construction.....\$1,500
 - b. Maintenance.....\$1,000
 - c. Restoration.....\$500
- Total Cost (C).....\$5,000

The “without treatment” condition reveals damages in the form of costs to remove sediment. Benefit (costs saved) are derived by subtracting the sediment removal costs under the “with treatment” condition.

1. Without treatment condition
8,000 cu.yd. (S) x \$2.00/cu.yd. (Y) = \$16,000 (SxY)
2. With treatment condition
 - a. Costs (C) described above =\$5,000
 - b. Removal costs for the 10% of sediment that passes through the control measure (measure is 90% effective)
 $(SxY)(1.00-P) = (16,000)(1.00 - .90) \dots \$1,600$
 - c. Total Cost = \$5,000 + \$1,600 = \$6,600
3. Benefits
 $\$16,000 - \$6,600 = \dots \dots \dots \$9,400$ (B)
(\$9,400 is money saved by installing sediment treatment)

Using the formula directly, the computations show the same results:

$$B = (SxY)-[c + (SxY)(1.00-P)]$$

$$B = (\$8,000 \times 2.00)-[(\$5,000 + (8,000 \times 2.00)(1.00-0.90)]$$

$$B = (\$16,000)-(\$5,000 + 1,600)$$

$$B = (\$16,000)-(\$6,600)$$

$$B = \$9,400$$

In this example, the more economical approach would be to install treatment measures rather than correct damages at a later date. A third alternative would be “do nothing” which would result in a higher flood damage hazard that would need evaluation under a more sophisticated analytical model. **Also, in this simple example, water quality issues (such as habitat loss) were not included even though society, in general, does place a value on such issues.**

Table C.1—Cost Table

The cost of implementing erosion and sediment control practices is highly variable and dependent upon many factors including availability and proximity of materials, time of year, prevailing wage rates, and regional cost trends to name a few. It is therefore difficult to develop cost estimates that are applicable statewide and year-round. The cost data contained in this chapter is based on actual bid prices from county and state highway construction projects, and suppliers for the year 2000. The following cost figures are provided to aid project planners in estimating erosion and sediment cost for feasibility studies. The actual dollar amounts are not recommended for use in estimating and bidding construction contracts. It is advisable to check with local suppliers and contractors for this purpose.

Erosion and Sediment Control Measures	\$ Low	\$ High	\$ Median
VEGETATIVE MEASURES			
Temporary Seeding	400/ac.	1,020/ac.	550/ac.
Permanent Seeding	1,500/ac.	2,690/ac.	2,000/ac.
Straw Mulch	660/ac.	1,000/ac.	750/ac.
Wood Mulch		23,000/ac.	23,000/ac.
Topsoil Stripping			1.60 cu.yd.
Topsoil Spreading			20/cu.yd.
Sodding			12/sq.yd.
RECP Netting	4.00/sq.yd.	4.53/sq.yd.	4.50 sq.yd.
Tree Protection			5/ln.ft.
BIOTECHNICAL MEASURES			
Willow Wattles			10/ln.ft.
Live Stakes			1.50/ln.ft.
Brush Layering			8/ln.ft.
RUNOFF CONTROL MEASURES			
Temporary Swale	2.00/ln.ft.	3.00/ln.ft.	2.50/ln.ft.
Rock Check Dam	130/ea.	450/ea.	200/ea.
Diversion or Grass Channel	6/ln.ft.	12/ln.ft.	10/ln.ft.
Riprap Channel	36.40/cu.yd.	55.00/cu.yd.	45.00/cu.yd.
Level Lip Spreader			25/ln.ft.
Rock Outlet Structure			1,000/ea.

**Table C.1 (cont'd)
Cost Table**

Erosion and Sediment Control Measures	\$ Low	\$ High	\$ Median
SEDIMENT CONTROL MEASURES			
Silt Fence	2.00/ln.ft.	2.68/ln.ft.	2.50/ln.ft.
Straw Bale Berm	3.25/ln.ft.	5.00/ln.ft.	4.00/ln.ft.
Stabilized Construction Entrance			30/cu.yd.
Temporary Sediment Basin			50/cu.yd.
Temporary Sediment Trap	600/ea.	2,000/ea.	1,500/ea.
Temporary Silt Dike			12/ln.ft.
Turbidity Curtain	4/sq.yd.	55/sq.yd.	20/sq.yd.
Filter Fabric Inlet Protection			100/ea.
Excavated Drop Inlet Protection			500/ea.
Temporary Sediment Tank			2,600/ea.
Block & Gravel Inlet Protection			500/ea.

**Table C.2
Annual Maintenance Cost As Percentage of Installation Cost**

<u>Item</u>	<u>Percentage (%)</u>
Seeding	20
Mulch	2
Silt Fence	100
Sediment Trap	20
Sediment Basin	25
Inlet Protection	60
Stabilized Construction Entrance	100
Rock Riprap	10
Grass Channel	10
Temporary Swale	50
Level Lip Spreader	50
Tree Protection	50
Rock Outlet Structure	20

Cost Estimate—SITE EXAMPLE

This example illustrates the use of Tables C.1 and C.2 to compute a cost estimate for erosion and sediment control for a site plan.

For the site example shown in Appendix F, the following cost estimate table (Table C.3) can be constructed. Unit costs are based on the median value in Table C.1. Since the construction schedule indicates a 9-month period to complete, we will use the annual maintenance figure in Table C.2 for the estimate.

It should be noted that many items are permanent practices, such as the rock riprap lined channel, permanent seeding, grass-lined channel, level lip spreader, and the rock outlet structures.

Table C.3
Cost Estimate For Site Example in Appendix F

<u>ITEM</u>	<u>QUANTITY</u>	<u>UNIT COST</u>	<u>AMOUNT (\$)</u>	<u>MAINTENANCE (\$)</u>	<u>TOTAL ESTIMATED COST (\$)</u>
1. Stabilized Construction Entrance	22.2 cu.yd.	\$30 cu.yd.	666	666	1,332
2. Rock Riprap	350 cu.yd.	\$45/cu.yd.	15,750	1,575	17,325
3. Seeding	2.5 ac.	\$2,000/ac.	5,000	1,000	6,000
4. Grass Channel	1,100 ln.ft.	\$10/ln.ft.	11,000	1,100	12,100
5. Temporary Swale	900 ln.ft.	\$2.50/ln.ft.	2,250	1,125	3,375
6. Level Lip Spreader	10 ln.ft.	\$25/ln.ft.	250	125	375
7. Drop Inlet Protection					
a. Filter Fabric	1 ea.	\$100/ea.	100	60	160
b. Block & Gravel	1 ea.	\$500/ea.	500	300	800
8. Silt Fence	100 ft.	2.50/ln.ft.	250	250	500
9. Tree Protection	80 ln.ft.	\$5.00/ln.ft.	400	200	600
10. Sediment Trap	1 ea.	\$1,500/ea.	1,500	300	1,800
11. Sediment Basin	285 cu.yd.	\$50/cu.yd.	14,250	3,600	17,850
12. Rock Outlet Structure	2 ea.	\$1,000/ea.	2,000	400	2,400
				<u>TOTAL</u>	64,617

References

1. Soil Conservation Service, USDA. Oct. 1977. National Handbook for Conservation Practices, U.S. Government Printing Office, Washington, D.C.
2. Soil Conservation Service, USDA. July 1984. Engineering Field Manual of Conservation Practices, 4th Printing, U.S. Government Printing Office, Washington, D.C.
3. Soil Conservation Service, USDA. June 1986. Urban Hydrology for Small Watersheds, Technical Release 55, Second Edition, U.S. Government Printing Office, Washington, D.C.
4. Soil Conservation Service, USDA. Sept. 1987. Drainage Guide for New York State, Syracuse, N.Y.

APPENDIX D
FERTILIZER LABELS AND PURE LIVE SEED

FERTILIZER GRADE

5-10-5

MEANS

5%	-	10%	-	5%
NITROGEN	-	PHOSPHORUS	-	POTASH
(N)	-	(P₂O₅)	-	(K₂O)

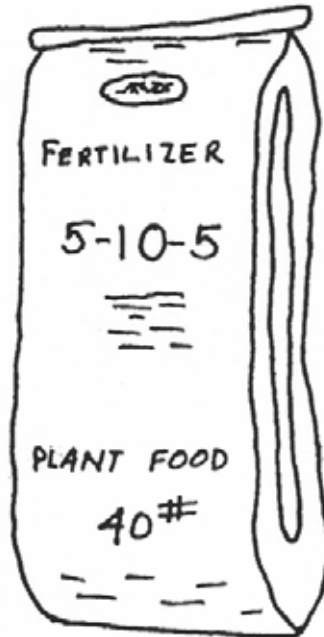

OR

2 lbs.	-	4 lbs.	-	2 lbs.
N/40 lb. bag	-	P₂O₅/40 lb. bag	-	K₂O/40 lb. bag

FERTILIZER CALCULATION EXAMPLE

EXAMPLE

A one-half acre lawn area needs 20 pounds of nitrogen (N) (40 pounds per acre) to achieve vigorous, green growth. The supplier has 10-10-10 in 50 pound bags. How many bags of fertilizer are needed?

NOTE: Always apply as closely as possible the required amount of fertilizer to meet the requirements of the site. Adding surplus nitrogen may cause pollution of drinking water and saltwater ecosystems. Excessive phosphorus may accelerate the aging process of freshwater ecosystems. Excessive amounts of N and K₂O may result in 'burning' the grass and killing it.

ANSWER

10-10-10 has 10% of each N, P₂O₅, and K₂O in the bag. Based on the N needed,

40-lbs/ac divided by 0.1 (10%) = 400 lbs. for one acre.

Divide by 2 for ½ acre=200 lbs. of fertilizer or 4-fifty pound bags of 10-10-10 fertilizer.

HOW TO CALCULATE PURE LIVE SEED

Pure Live Seed, or PLS, refers to the amount of live seed in a lot of bulk seed. The cost of PLS seed is proportionally higher than bulk price. Calculating Pure Live Seed can help you save money and do the best jobs possible. Take a look at the label on a bag of seed. You will find a lot of information such as the type of seed, the supplier, test date and where the seed came from. More importantly, you will see seed purity, and germination percent. To compute pure live seed, multiply the "germination percent" times the "purity" and divide that by "100" to get PURE LIVE SEED.

(*Purity* is the percentage of pure seed. A high percentage of pure seed is required for crop seed, but some chaffy grasses and native plants may have a lower percent purity. A high pure seed percentage will provide the best results.

Germination percentage is the percentage of pure seed that will produce normal plants when planted under favorable conditions.)

Example:

$$\frac{96\% \text{ germination} \times 75\% \text{ purity}}{100} = 72\% \text{ PLS}$$

Then divide the "Cost per pound" by "Pure Live Seed" and you will have the cost per pound of the Pure Live Seed.

$$\frac{\$2.50 \text{ per pound}}{72\%} = \$3.47 \text{ per Pound of PLS}$$

APPENDIX E
EROSION & SEDIMENT CONTROL PLAN
FOR SMALL HOMESITE CONSTRUCTION

CONTENTS

	<u>Page</u>
List of Figures	
Definition.....	E.1
Purpose.....	E.1
Criteria.....	E.1
Specifications.....	E.1
Small Homesite Minimum Requirements.....	E.1
Small Homesite Examples (with Vegetative Requirements and Compliance Form).....	E.3

Appendix prepared by:

Paula Smith, CPESC, CPSWQ
Executive Director
Monroe County Soil & Water Conservation District

List of Figures

<u>Figure</u>	<u>Title</u>	<u>Page</u>
E.1	Erosion Control Plan Condition 1.....	E.3
E.2	Erosion Control Plan Condition 2.....	E.5
E.3	Erosion Control Plan Condition 3.....	E.7
E.4	Erosion Control Plan Condition 4.....	E.9
E.5	Construction Details for Stabilized Construction Entrance and Silt Fence.....	E.11
E.6	Construction Details for Straw Bale Dike and Rock Check Dam.....	E.12

EROSION AND SEDIMENT CONTROL PLAN FOR SMALL HOMESITE CONSTRUCTION

Definition

Small homesite erosion and sediment control plans are a group of minimum erosion and sediment control practices and management techniques that apply to small homesite construction activity on a single residential lot, in order to prevent polluted discharge.

Purpose

This appendix lays out a series of minimum requirements for erosion and sediment control, and management practices that may be used to meet these requirements. Use of these templates will help show compliance with the general requirements for construction activities that require basic stormwater pollution prevention plans (SWPPP). This applies to the construction of small homesites. The owner/developer must complete the relevant conditions (1-4), or small parcel erosion and sediment control plan included in this section, and submit the NOI in order to meet compliance with the SPDES General Permit for Stormwater Discharges From Construction Activities.

Criteria

Generally, several types of practices are required on any one site for effective erosion and sediment control. There are three broad categories of construction-related practices for controlling erosion and sediment on small homesite developments:

1. **Cover practices** prevent erosion by protecting the soil surface from rainfall and runoff. Prevention of erosion is the most preferable and cost-effective approach. These practices include: protection of existing vegetation; temporary covering of exposed soil by mulching, matting, or covering; and permanent site stabilization by topsoiling, seeding, and/or sodding.

2. **Structural Practices** are structural controls that either reduce erosion, control runoff, or keep sediment on the construction site. Examples of these practices include stabilized construction entrances, filter fences, sediment traps, berms, and check dams.

3. **Management Measures** are construction management methods that prevent or reduce erosion potential and ensure the proper functioning of erosion and sediment control practices. Careful construction management can dramatically reduce the costs associated with erosion and sediment problems. Examples of these management measures include:

- Preserving existing trees and grass where possible to prevent erosion;

- Re-vegetating the site as soon as possible;
- Locating soil piles away from roads or waterways;
- Limiting tracking of mud onto streets by requiring all vehicles to use designated access drives;
- Removing sediment carried off-site by vehicles or storms;
- Installing downspout extenders to prevent erosion from roof runoff; and
- Maintaining erosion and sediment practices through sediment removal, structure replacement, etc.

Specifications

Each construction site is different. The owner/developer of a small construction site may choose and follow one of the four variations of ESC plans included in this section to develop a SWPPP in compliance with the SPDES Construction Permit For Stormwater Discharges From Construction Activities. However, because of the general nature of the following conditions, **the plans included in this section may not cover all of the resource protection needs on a particular site, and this form does not exempt an owner from the responsibility of filing an NOI.**

Small Homesite Minimum Requirements:

1. Stabilized Construction Entrance:

To prevent vehicles and equipment from tracking sediment and mud off-site, apply gravel or crushed rock to the driveway area and restrict traffic to this one route. This practice will help keep soil from sticking to tires and stop soil from washing off into the street. Carry out periodic inspections and maintenance including washing, top-dressing with additional stone, reworking, and compaction. Plan for periodic street cleaning to remove any sediment that may have been tracked off-site. Remove sediment by shoveling or sweeping and transport to a suitable disposal area where it can be stabilized.

2. Stabilization of Denuded Areas:

Stabilization measures must be initiated as soon as practicable, but in no case more than 14 days after the construction activity has ceased. In frozen ground conditions, stabilization measures must be initiated as soon as practicable. Where construction activity on a portion of the site is temporarily ceased, and earth-disturbing activities will be resumed within twenty-one (21) days, temporary stabilization measures need not be initiated on that portion of the site.

Stabilize denuded areas by implementing soil covering practices (e.g. mulching, matting, sodding). Exposed soils are the most prone to erosion from rainfall and runoff. Vegetation helps protect the soil from these forces and provides natural erosion control. Plan construction to limit

the amount of exposed area, and avoid grading activities during the rainy season (November through March) as much as possible. Clearing limits should be clearly marked and kept as small as possible. Once construction is completed, the site must be permanently stabilized with topsoiling, seeding and plantings, or sodding if needed.

3. Protection of Adjacent Properties:

Keep sediment on-site by using structural and source control practices (e.g. vegetative buffer strips, sediment barriers, soil berms or dikes, etc). See Sections 3, 4, or 5 as appropriate. Wherever possible, preserve a buffer of existing vegetation around the site boundary. This will help to decrease runoff velocities and trap sediment suspended in the runoff. Other structural controls such as filter fence or straw bale barriers should also be used to filter runoff and trap sediment on-site.

When excavating basement soils, move the soil to a location that is, or will be, vegetated, such as in the backyard or side yard area. This will increase the distance eroded soil must travel, through vegetation, to reach the storm sewer system. Piles should be situated so that sediment does not run into the street or adjoining yards. Soil piles should be temporarily seeded and circled with silt fence until the soil is either replaced or removed. Backfill basement walls as soon as possible and rough grade the lot. This will eliminate the large soil mounds, which are highly erodible, and prepare the lot for temporary cover. After backfilling, grade or remove excess soil from the site quickly, to eliminate any sediment loss from surplus fill.

4. Concentrated Flow:

For constructed drainage ways, or other areas of concentrated flow, install check dams according to the specifications on page E.12 to reduce erosion in the channel. As with other erosion controls, check dams must be inspected regularly. Remove sediment accumulated behind the dam as needed to allow channel to drain through the stone check dam and prevent large flows from carrying

sediment over the dam. Replace stones as needed to maintain the design cross section of the structures. Sediment removal is crucial to the effectiveness of the dam—if not maintained, high flows could cause erosion around the sides of the structures, adding significant sediment loads downstream.

5. Maintenance:

Maintain erosion and sediment control practices through regular inspection. Regular maintenance is extremely important for the proper operation of structural practices. After initial groundbreaking, the builder shall conduct site inspections at least once every 14 calendar days and within 24 hours of the end of a storm event of 0.5 inches or greater.

6. Other Practices:

Use additional practices as required by the local plan approval authority to mitigate effects of increased runoff. This may include providing additional controls to a locally protected stream or resource area, protecting riparian corridors (vegetative stream buffers), etc. Individual homeowners and/or developers are responsible for researching additional requirements related to erosion and sediment runoff control established by their local jurisdictions.

Figure E.1 Erosion Control Plan Condition 1

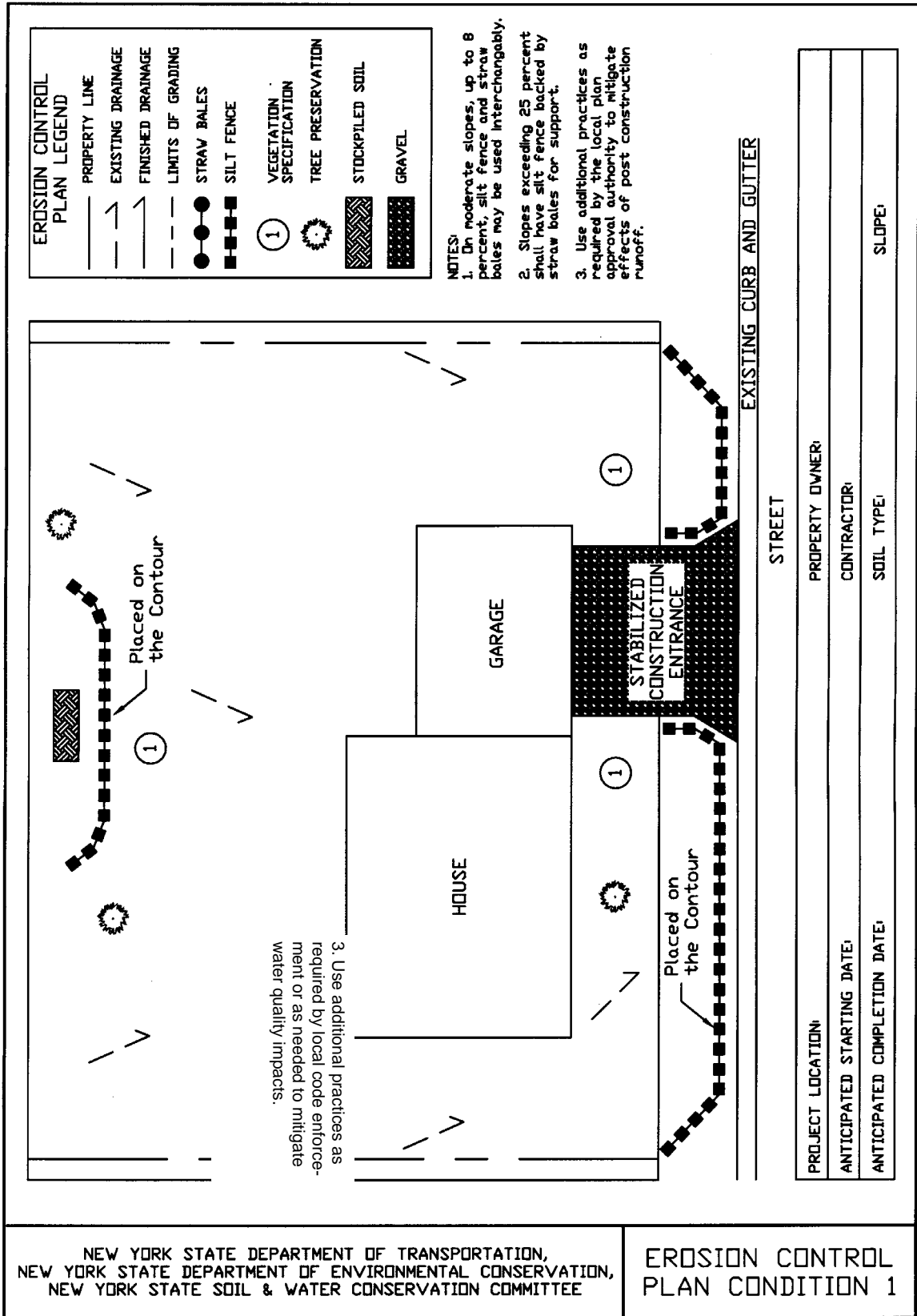

Condition 1—Vegetative Requirements & Compliance Form

Vegetation Requirements:

1.) Site Preparation

- A. Install needed water and erosion control measures and bring area to be seeded to desired grades using a minimum of 4 in. topsoil.
- B. Prepare seedbed by loosening soil to a depth of 4-6 inches.
- C. Lime to a pH of 6.5
- E. Fertilize as per soil test or, if fertilizer must be applied before soil test results are received, apply 850 pounds of 5-10-10 or equivalent per acre (20 lbs/1,000 sq. ft.)
- F. Incorporate lime and fertilizer in top 2-4 inches of topsoil.
- G. Smooth. Remove all stones over 1 inch in diameter, sticks, and foreign matter from the surface. Firm the seedbed.

2.) Planting—Sunny Location.

Use a cultipacker type seeder if possible. Seed to a depth of 1/8 to 1/4 inch. If seed is to be broadcast, cultipack or roll after seeding. If hydroseeded, lime and fertilizer may be applied through the seeder and rolling is not practical. Seed using the following mix and rates:

<u>Species (% by weight)</u>	<u>lbs/1,000sq. ft</u>	<u>lbs./acre</u>
65% Kentucky bluegrass blend.....	2.0-2.6.....	85-114
20% perennial ryegrass.....	0.6-0.8.....	26-35
15% fine fescue.....	<u>0.4-0.6.....</u>	<u>19-26</u>
Total.....	3.0-4.0.....	130-175
or,		
100% Tall fescue, Turf-type, fine leaf.....	3.4-4.6.....	150-200

- 3.) When using the cultipacker or broadcast seed method, mulch using small grain straw, applied at a rate of 2 tons per acre; and anchor with a netting or tackifier. Hydroseed applications should include mulch, fertilizer and seed.

Common white clover can be added to mixtures at the rate of 1-2 lbs/acre to help maintain green color during the dry summer period, however, they will not withstand heavy traffic. Fertilizing—First year, (spring seedlings) three to four weeks after germination apply 1 pound nitrogen/1,000 square feet using a complete fertilizer with a 2-1-1 or 4-1-3 ratio or as recommended by soil test results. For summer and early fall seedings, apply as above unless air temperatures are above 85°F for extended period. Wait until heat wave is over to fertilize. For late fall/ winter seedings, fertilize in spring. Restrict use—new seedlings should be protected from use for one full year to allow development of a dense sod with good root structure.

Certification Statement

Please complete and sign this 2-sided document (with Typical Erosion Control Plan) and attach to BLUEPRINTS and SITE PLAN prior to any earth disturbance. These documents must be kept on site and be available for review as requested by any agent of the NYSDEC. **This 2-sided form can be used as a basic stormwater pollution prevention plan, but will not exempt a landowner from filing a Notice of Intent.**

"I certify under penalty of law that I understand and agree to comply with the terms and conditions of the ESC plan for the construction site identified in such ESC plan as a condition of authorization to discharge stormwater. I also understand that the operator must comply with the terms and conditions of the New York State Pollutant Discharge Elimination System ("SPDES") general permit for stormwater discharges from construction activities and that it is unlawful for any person to cause or contribute to a violation of water quality standards."

Builder/Contractor (print)

Signature

Address

Telephone

Fax

E-mail

Figure E.2 Erosion Control Plan Condition 2

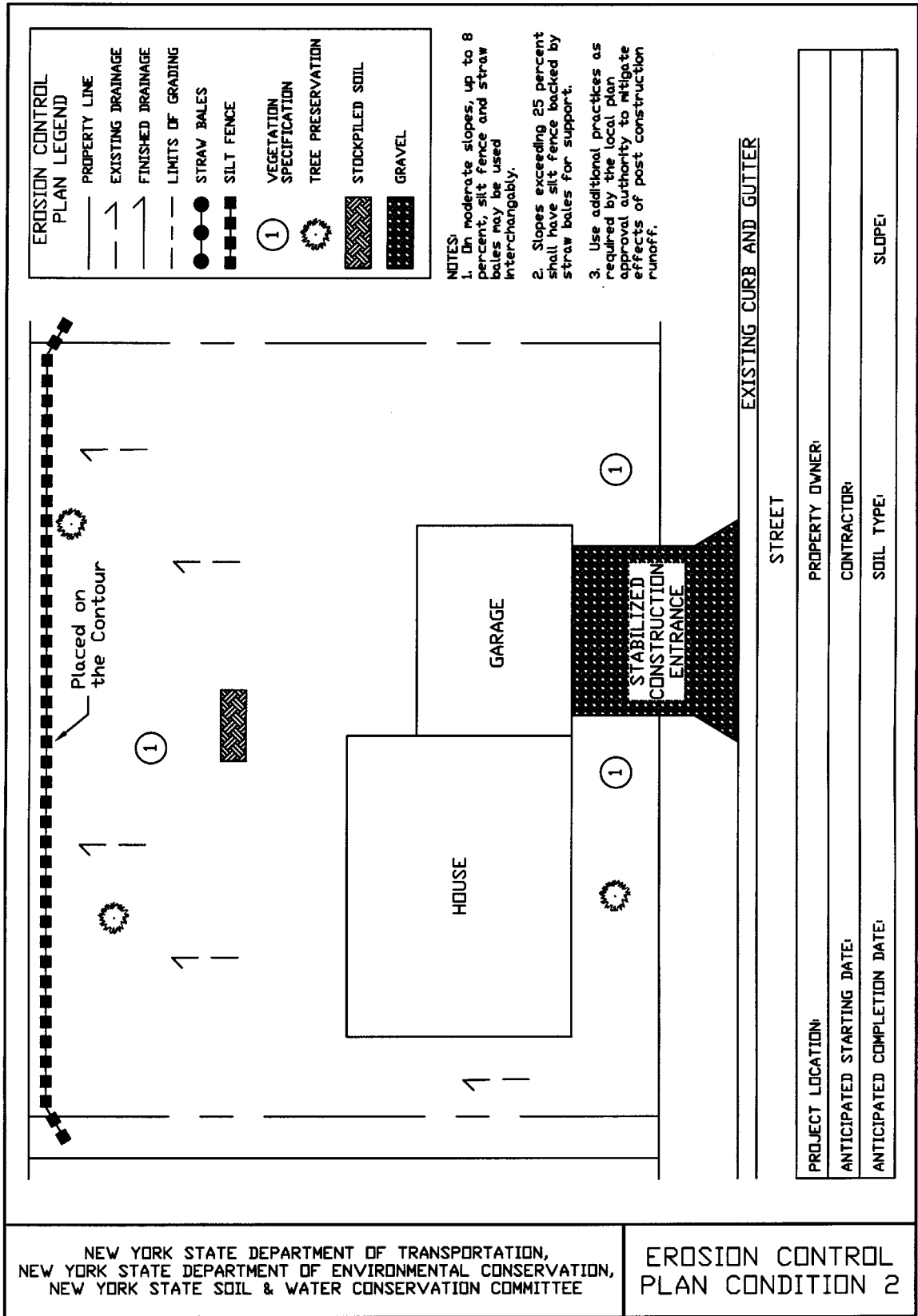

Condition 2—Vegetative Requirements & Compliance Form

Vegetation Requirements:

1.) Site Preparation

- A. Install needed water and erosion control measures and bring area to be seeded to desired grades using a minimum of 4 in. topsoil.
- B. Prepare seedbed by loosening soil to a depth of 4-6 inches.
- C. Lime to a pH of 6.5
- E. Fertilize as per soil test or, if fertilizer must be applied before soil test results are received, apply 850 pounds of 5-10-10 or equivalent per acre (20 lbs/1,000 sq. ft.)
- F. Incorporate lime and fertilizer in top 2-4 inches of topsoil.
- G. Smooth. Remove all stones over 1 inch in diameter, sticks, and foreign matter from the surface. Firm the seedbed.

2.) Planting—Sunny Location.

Use a cultipacker type seeder if possible. Seed to a depth of 1/8 to 1/4 inch. If seed is to be broadcast, cultipack or roll after seeding. If hydroseeded, lime and fertilizer may be applied through the seeder and rolling is not practical. Seed using the following mix and rates:

<u>Species (% by weight)</u>	<u>lbs/1,000sq. ft</u>	<u>lbs./acre</u>
65% Kentucky bluegrass blend.....	2.0-2.6.....	85-114
20% perennial ryegrass.....	0.6-0.8.....	26-35
15% fine fescue.....	<u>0.4-0.6.....</u>	<u>19-26</u>
Total.....	3.0-4.0.....	130-175
or,		
100% Tall fescue, Turf-type, fine leaf.....	3.4-4.6.....	150-200

- 3.) When using the cultipacker or broadcast seed method, mulch using small grain straw, applied at a rate of 2 tons per acre; and anchor with a netting or tackifier. Hydroseed applications should include mulch, fertilizer and seed.

Common white clover can be added to mixtures at the rate of 1-2 lbs/acre to help maintain green color during the dry summer period, however, they will not withstand heavy traffic. Fertilizing—First year, (spring seedlings) three to four weeks after germination apply 1 pound nitrogen/1,000 square feet using a complete fertilizer with a 2-1-1 or 4-1-3 ratio or as recommended by soil test results. For summer and early fall seedings, apply as above unless air temperatures are above 85°F for extended period. Wait until heat wave is over to fertilize. For late fall/ winter seedings, fertilize in spring. Restrict use—new seedlings should be protected from use for one full year to allow development of a dense sod with good root structure.

Certification Statement

Please complete and sign this 2-sided document (with Typical Erosion Control Plan) and attach to BLUEPRINTS and SITE PLAN prior to any earth disturbance. These documents must be kept on site and be available for review as requested by any agent of the NYSDEC. **This 2-sided form can be used as a basic stormwater pollution prevention plan, but will not exempt a landowner from filing a Notice of Intent.**

"I certify under penalty of law that I understand and agree to comply with the terms and conditions of the ESC plan for the construction site identified in such ESC plan as a condition of authorization to discharge stormwater. I also understand that the operator must comply with the terms and conditions of the New York State Pollutant Discharge Elimination System ("SPDES") general permit for stormwater discharges from construction activities and that it is unlawful for any person to cause or contribute to a violation of water quality standards."

 Builder/Contractor (print) Signature

 Address

 Telephone Fax E-mail

Figure E.3 Erosion Control Plan Condition 3

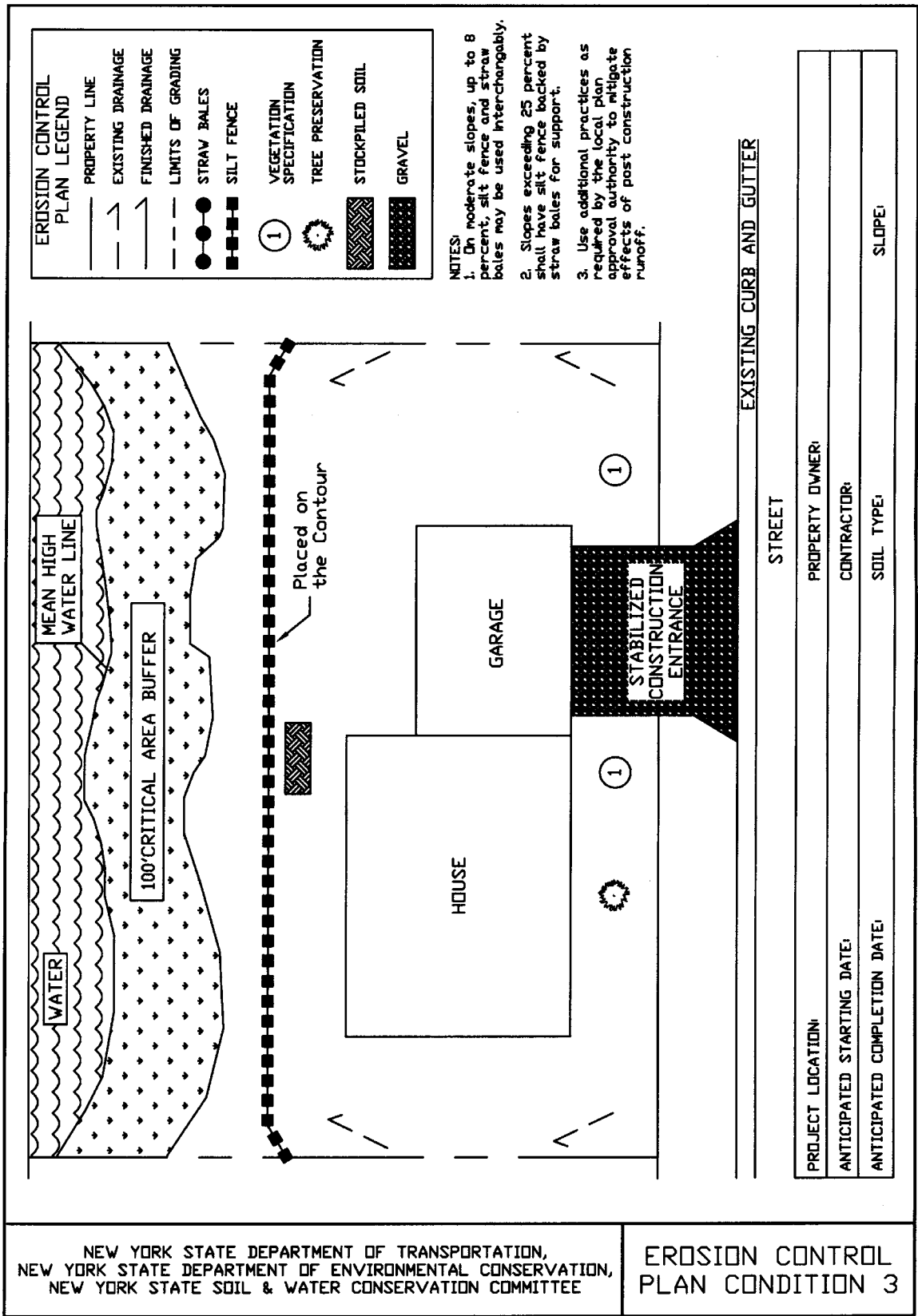

Condition 3—Vegetative Requirements & Compliance Form

Vegetation Requirements:

1.) Site Preparation

- A. Install needed water and erosion control measures and bring area to be seeded to desired grades using a minimum of 4 in. topsoil.
- B. Prepare seedbed by loosening soil to a depth of 4-6 inches.
- C. Lime to a pH of 6.5
- E. Fertilize as per soil test or, if fertilizer must be applied before soil test results are received, apply 850 pounds of 5-10-10 or equivalent per acre (20 lbs/1,000 sq. ft.)
- F. Incorporate lime and fertilizer in top 2-4 inches of topsoil.
- G. Smooth. Remove all stones over 1 inch in diameter, sticks, and foreign matter from the surface. Firm the seedbed.

2.) Planting—Sunny Location.

Use a cultipacker type seeder if possible. Seed to a depth of 1/8 to 1/4 inch. If seed is to be broadcast, cultipack or roll after seeding. If hydroseeded, lime and fertilizer may be applied through the seeder and rolling is not practical. Seed using the following mix and rates:

<u>Species (% by weight)</u>	<u>lbs/1,000sq. ft</u>	<u>lbs./acre</u>
65% Kentucky bluegrass blend.....	2.0-2.6.....	85-114
20% perennial ryegrass.....	0.6-0.8.....	26-35
15% fine fescue.....	<u>0.4-0.6.....</u>	<u>19-26</u>
Total.....	3.0-4.0.....	130-175
or,		
100% Tall fescue, Turf-type, fine leaf.....	3.4-4.6.....	150-200

- 3.) When using the cultipacker or broadcast seed method, mulch using small grain straw, applied at a rate of 2 tons per acre; and anchor with a netting or tackifier. Hydroseed applications should include mulch, fertilizer and seed.

Common white clover can be added to mixtures at the rate of 1-2 lbs/acre to help maintain green color during the dry summer period, however, they will not withstand heavy traffic. Fertilizing—First year, (spring seedlings) three to four weeks after germination apply 1 pound nitrogen/1,000 square feet using a complete fertilizer with a 2-1-1 or 4-1-3 ratio or as recommended by soil test results. For summer and early fall seedings, apply as above unless air temperatures are above 85°F for extended period. Wait until heat wave is over to fertilize. For late fall/ winter seedings, fertilize in spring. Restrict use—new seedlings should be protected from use for one full year to allow development of a dense sod with good root structure.

Certification Statement

Please complete and sign this 2-sided document (with Typical Erosion Control Plan) and attach to BLUEPRINTS and SITE PLAN prior to any earth disturbance. These documents must be kept on site and be available for review as requested by any agent of the NYSDEC. **This 2-sided form can be used as a basic stormwater pollution prevention plan, but will not exempt a landowner from filing a Notice of Intent.**

"I certify under penalty of law that I understand and agree to comply with the terms and conditions of the ESC plan for the construction site identified in such ESC plan as a condition of authorization to discharge stormwater. I also understand that the operator must comply with the terms and conditions of the New York State Pollutant Discharge Elimination System ("SPDES") general permit for stormwater discharges from construction activities and that it is unlawful for any person to cause or contribute to a violation of water quality standards."

 Builder/Contractor (print) Signature

 Address

 Telephone Fax E-mail

Figure E.4 Erosion Control Plan Condition 4

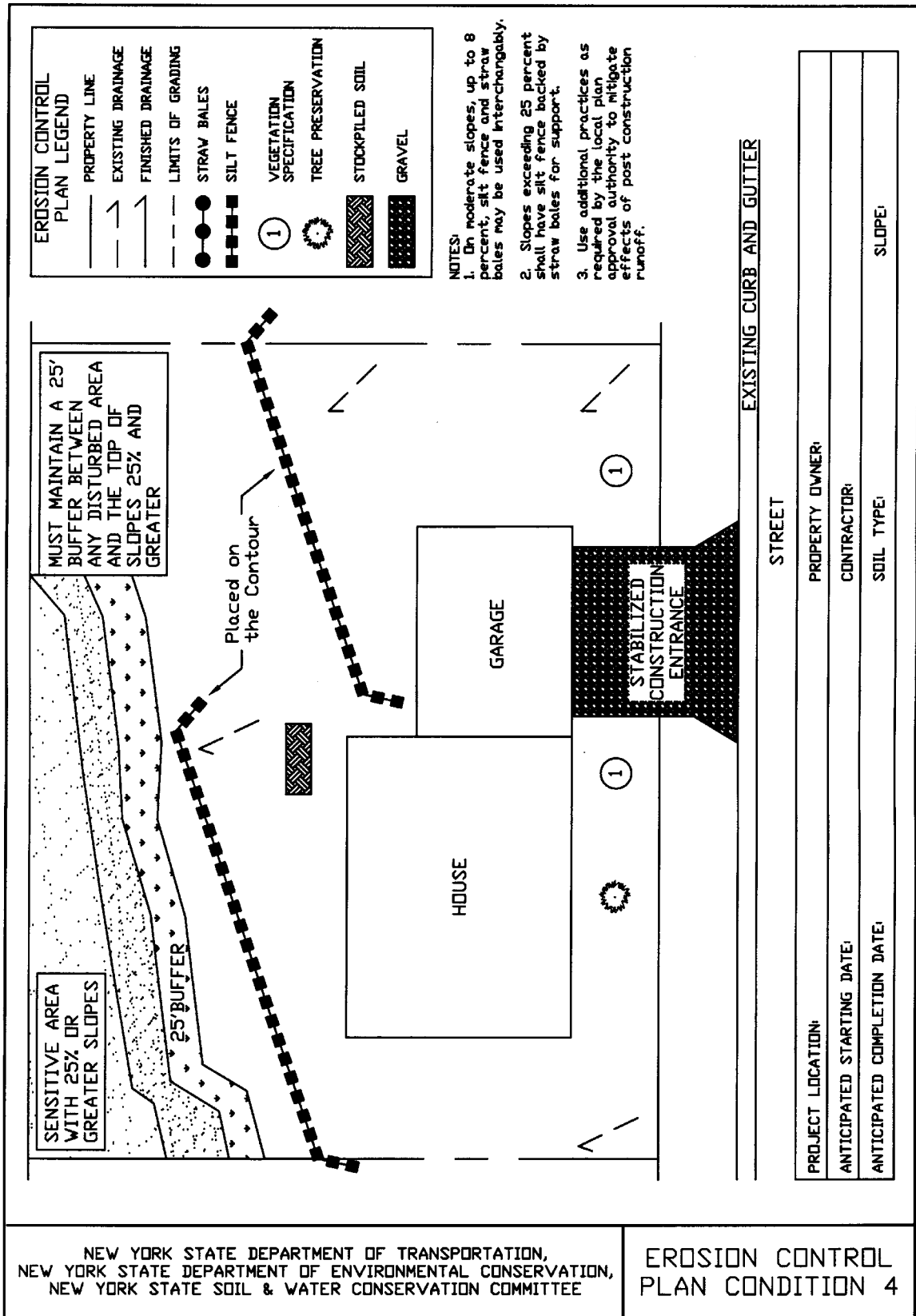

Condition 4—Vegetative Requirements & Compliance Form

Vegetation Requirements:

1.) Site Preparation

- A. Install needed water and erosion control measures and bring area to be seeded to desired grades using a minimum of 4 in. topsoil.
- B. Prepare seedbed by loosening soil to a depth of 4-6 inches.
- C. Lime to a pH of 6.5
- E. Fertilize as per soil test or, if fertilizer must be applied before soil test results are received, apply 850 pounds of 5-10-10 or equivalent per acre (20 lbs/1,000 sq. ft.)
- F. Incorporate lime and fertilizer in top 2-4 inches of topsoil.
- G. Smooth. Remove all stones over 1 inch in diameter, sticks, and foreign matter from the surface. Firm the seedbed.

2.) Planting—Sunny Location.

Use a cultipacker type seeder if possible. Seed to a depth of 1/8 to 1/4 inch. If seed is to be broadcast, cultipack or roll after seeding. If hydroseeded, lime and fertilizer may be applied through the seeder and rolling is not practical. Seed using the following mix and rates:

<u>Species (% by weight)</u>	<u>lbs/1,000sq. ft</u>	<u>lbs./acre</u>
65% Kentucky bluegrass blend.....	2.0-2.6.....	85-114
20% perennial ryegrass.....	0.6-0.8.....	26-35
15% fine fescue.....	<u>0.4-0.6.....</u>	<u>19-26</u>
Total.....	3.0-4.0.....	130-175
or,		
100% Tall fescue, Turf-type, fine leaf.....	3.4-4.6.....	150-200

- 3.) When using the cultipacker or broadcast seed method, mulch using small grain straw, applied at a rate of 2 tons per acre; and anchor with a netting or tackifier. Hydroseed applications should include mulch, fertilizer and seed.

Common white clover can be added to mixtures at the rate of 1-2 lbs/acre to help maintain green color during the dry summer period, however, they will not withstand heavy traffic. Fertilizing—First year, (spring seedlings) three to four weeks after germination apply 1 pound nitrogen/1,000 square feet using a complete fertilizer with a 2-1-1 or 4-1-3 ratio or as recommended by soil test results. For summer and early fall seedings, apply as above unless air temperatures are above 85°F for extended period. Wait until heat wave is over to fertilize. For late fall/ winter seedings, fertilize in spring. Restrict use—new seedlings should be protected from use for one full year to allow development of a dense sod with good root structure.

Certification Statement

Please complete and sign this 2-sided document (with Typical Erosion Control Plan) and attach to BLUEPRINTS and SITE PLAN prior to any earth disturbance. These documents must be kept on site and be available for review as requested by any agent of the NYSDEC. **This 2-sided form can be used as a basic stormwater pollution prevention plan, but will not exempt a landowner from filing a Notice of Intent.**

"I certify under penalty of law that I understand and agree to comply with the terms and conditions of the ESC plan for the construction site identified in such ESC plan as a condition of authorization to discharge stormwater. I also understand that the operator must comply with the terms and conditions of the New York State Pollutant Discharge Elimination System ("SPDES") general permit for stormwater discharges from construction activities and that it is unlawful for any person to cause or contribute to a violation of water quality standards."

Builder/Contractor (print)

Signature

Address

Telephone

Fax

E-mail

Figure E.5
Construction Details for Stabilized Construction Entrance and Silt Fence

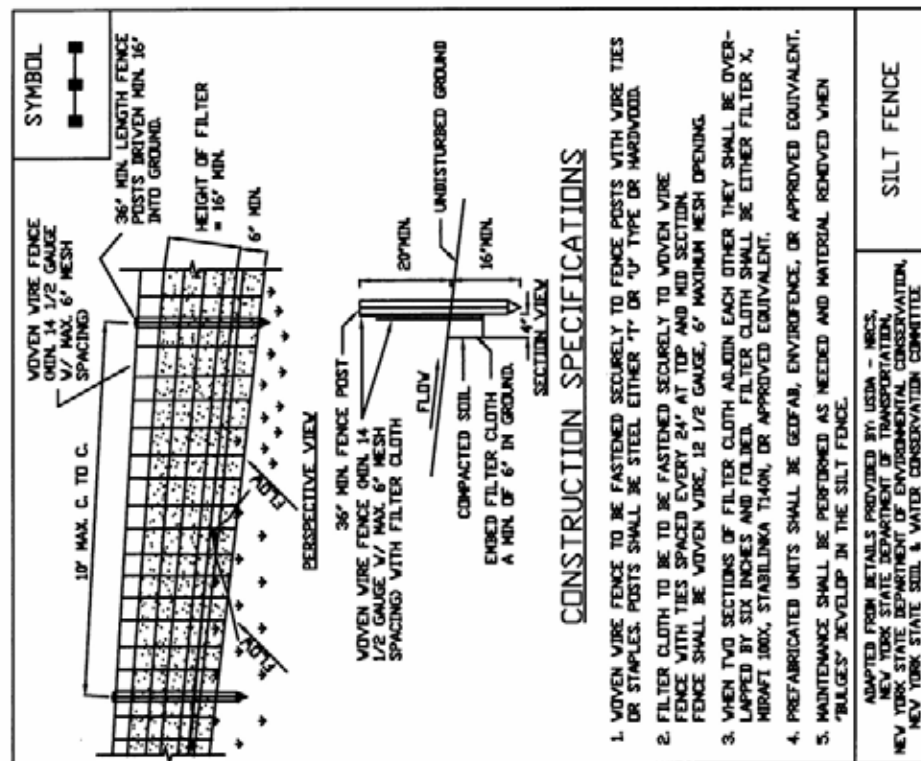
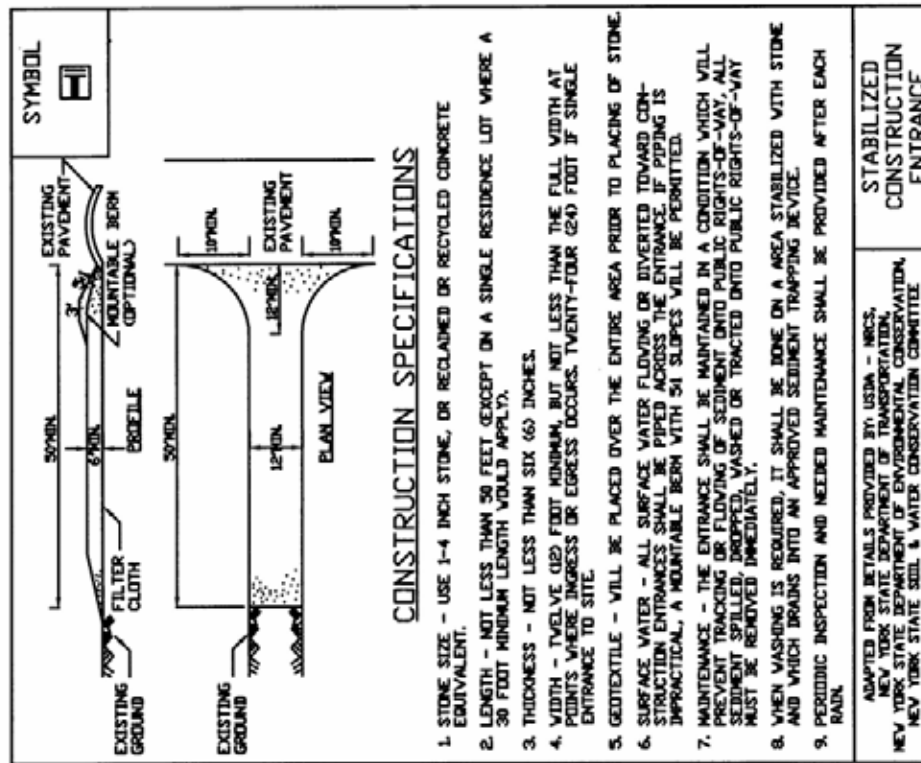
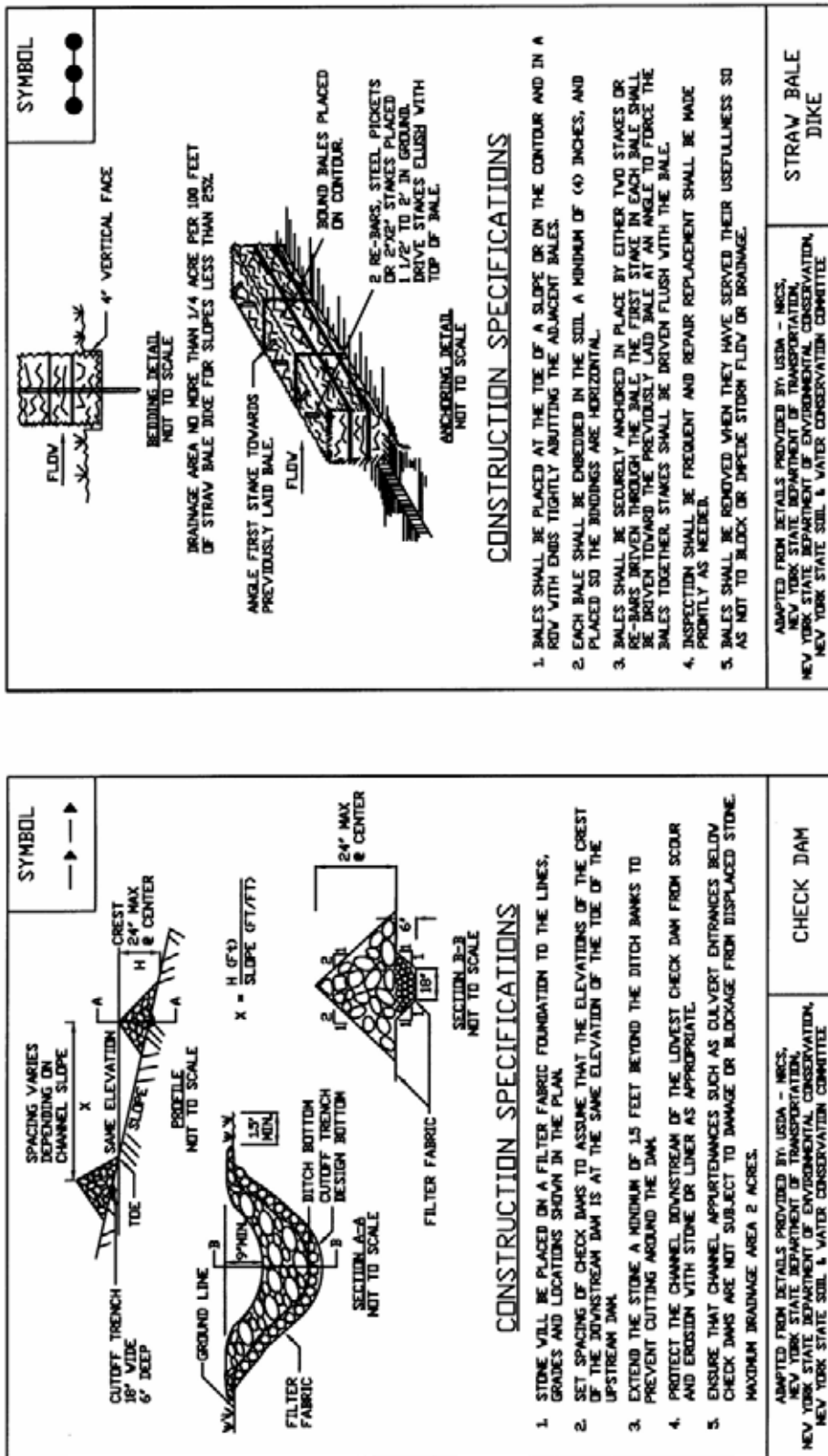

Figure E.6
Construction Details for Straw Bale Dike and Check Dam



APPENDIX F
SAMPLE EROSION AND SEDIMENT CONTROL PLAN

CONTENTS

	<u>Page</u>
Introduction.....	F.1
Narrative.....	F.2
Planned Erosion and Sedimentation Control Practices.....	F.3
Construction Schedule.....	F.5
Maintenance Plan.....	F.6
Vicinity Map.....	F.6
Site Topographic Map—Exhibit 1.....	F.7
Site Development Map—Exhibit 2.....	F.8
Site Erosion and Sediment Control Plan—Exhibit 3.....	F.9
Drawings and Specifications.....	F.10
Vegetative Plan.....	F.31

This appendix is adapted from the North Carolina Erosion and Sediment Control Planning and Design Manual, North Carolina Sedimentation Control Commission by Donald W. Lake Jr., P.E., CPESC, CPSWQ, Engineering Specialist, New York State Soil & Water Conservation Committee

EXAMPLE EROSION AND SEDIMENT CONTROL PLAN

Introduction

What follows is an example erosion and sedimentation control plan based on one from the files of the State of North Carolina. The site is located in the Piedmont region. The plan was modified to demonstrate the application of a variety of erosion and sedimentation control practices.

This example plan was developed in detail for instructive purposes. The specific number of maps, practices, drawings, specifications, and calculations required depends on the size and complexity of the development. The vegetative treatment is from a sample North Carolina plan and no attempt was made to modify the treatment for New York conditions. The designer should select the most practical and effective practices to control erosion and prevent sediment from leaving the site. The plan should be organized and presented in a clear, concise manner. Sufficient design and background information should be included to facilitate review by erosion control personnel. Construction details should be precise and clear for use by an experienced general contractor.

An acceptable erosion and sedimentation control plan must, at a minimum, contain:

1. brief narrative
2. construction schedule
3. maintenance plan
4. vicinity map
5. site topographic map including soil survey information
6. site development plan
7. erosion and sedimentation control plan drawing¹
8. detail drawings and specifications
9. vegetative plan

Although this example is from North Carolina, its organization, analysis, and detail are appropriate in all locations. The original content of the example was retained for continuity. Regarding practices selected, refer to the flow charts in Section 2 to correlate with the control groups. In the example, the temporary diversion equates to New York's earth dike. Supporting calculations for these practices are not included to maintain the size of this publication. However, the criteria in each of the practice standards in the appropriate sections, will guide the user in their design.

¹ On large projects, the designer should show the erosion and sediment control plan on separate sheets, reflecting the actual topography at the time the phase starts, and show only existing and final grades for that phase under construction.

Narrative

Project Description

The purpose of the project is to construct two large commercial buildings with associated paved roads and parking area. Another building will be added in the future. Approximately 6 acres will be disturbed during this construction period. The site is 11.1 acres located in Granville County, 2 miles north of Deal, NC, off Terri Road (see Vicinity Map).

Site Description

The site has rolling topography with slopes generally 4 to 6%. Slopes steepen to 10 to 20% in the northwest portion of the property where a small, healed-over gully serves as the principal drainageway for the site. The site is now covered with volunteer heavy, woody vegetation, predominately pines, 15 to 20 ft. high. There is no evidence of significant erosion under present site conditions. The old drainage gully indicates severe erosion potential and receives flow from 5 acres of woods off-site. There is one large oak tree, located in the western central portion of the property, and a buffer area, fronting Terri Road, that will be protected during construction.

Adjacent Property

Land use in the vicinity is commercial/industrial. The land immediately to the west and south has been developed for industrial use. Areas to the north and east are undeveloped and heavily wooded, primarily in volunteer pine. Hocutt Creek, the off-site outlet for runoff discharge, is presently a well stabilized, gently flowing perennial stream. Sediment control measures will be taken to prevent damage to Hocutt Creek. Approximately 5 acres of wooded area to the east contribute runoff into the construction area.

Soils

The soil in the project area is mapped as Creedmoor sandy loam in B and C slope classes. Creedmoor soils are considered moderately well to somewhat poorly drained with permeability rates greater than 6 inches/hour at the surface, but less than 0.1 inches/hour in the subsoil. The subsurface is pale brownstone loam, 6 inches thick. The subsoil consists of a pale brown and brownish yellow sandy clay loam ranging from light gray clay, 36 inches thick. Below 36 inches is a layer of fine sandy loam to 77 inches. The soil erodibility factor (K value) ranges from 0.20 at the surface to 0.37 in the subsoil.

Due to the soil permeability of the subsoil that will be exposed during grading, a surface wetness problem with high runoff is anticipated following significant rainfall events. No groundwater problem is expected. The tight clay in the subsoil will make vegetation difficult to establish. A small amount of topsoil exists on-site and will be stockpiled for use in landscaping.

Planned Erosion and Sedimentation Control Practices

- 1. Sediment Basin:** A sediment basin will be constructed in the northwest corner of the property. All water from disturbed areas, about 6 acres, will be directed to the basin before leaving the site (Note: The undisturbed areas to the east and north could have been diverted, but this was not proposed because it would have required clearing to the property line to build the diversion and the required outlet structure). See pages F.10-F.12 for details.
- 2. Temporary Gravel Construction Entrance/Exit:** A temporary gravel construction entrance will be installed near the northwest corner of the property. During wet weather it may be necessary to wash vehicle tires at this location. The entrance will be graded so that runoff water will be directed to an inlet protection structure and away from the steep fill area to the north. See page F.12 for specifications.
- 3. Temporary Block and Gravel Drop Inlet Protection:** A temporary block and gravel drop inlet protection will be installed at the drop inlet located on the south side of the construction entrance. Runoff from the device will be directed into the sediment basin (Note: The presence of this device reduces the sediment load on the sediment basin and provides sediment protection for the pipe. In addition, sediment removal at this point is more convenient than from the basin). See page F.13 for specifications.
- 4. Temporary Diversion:** Temporary diversions will be constructed above the 3:1 cut slopes south of Buildings A and B to prevent surface runoff from eroding these banks (Note: Sediment-free water may be diverted away from the project sediment basin). A temporary diversion will be constructed near the middle of the disturbed area to break up this long, potentially erosive slope, should the grading operation be temporarily discontinued. A temporary diversion dike will be constructed along the top edge of the fill slope at the end of each day during the filling operation to protect the fill slope. This temporary diversion will outlet to the existing undisturbed channel near the north edge of the construction site and/or to the temporary inlet protection device at the construction entrance as the fill elevation increases. See page F.14 for specifications.
- 5. Level Spreader:** A level spreader will serve as the outlet for the diversion east of Building A and south of Building B. The area below the spreader is relatively smooth and heavily vegetated with a slope of approximately 4%. See page F.15 for specifications.
- 6. Tree Preservation and Protection:** A minimum 2.0 ft. high protective fence will be erected around a large oak tree at the dripline to prevent damage during construction. Sediment fence materials may be used for this purpose. See page F.16 for specifications.
- 7. Land Grading:** Heavy grading will be required on approximately 6 acres. The flatter slope after grading will reduce the overall erosion potential of the site. The buildings will be located on the higher cut areas, and the access road and open landscaped areas will be located on fill areas. See pages F.16–F.17 for specifications.

All cut slopes will be 3:1 or flatter to avoid instability due to wetness, provide fill material, give an open area around the buildings, and allow vegetated slopes to be mowed. Cut slopes will be fine graded immediately after rough grading; the surface will be disked and vegetated according to the Vegetation Plan (pages F.29–F.31).

Fill slopes will be 2:1 with fill depths as much as 12 to 15 ft. Fill will be placed in layers not to exceed 9 inches in depth and compacted (Note: Fills of this depth should have detailed compaction specifications in the general construction contract. These specifications are not part of the erosion and sedimentation control plan).

The fill slope in the north portion of the property is the most vulnerable area to erosion on the site. Temporary diversions will be maintained at the top of this fill slope at all times, and the filling operation will be graded to prevent overflow to the north. Filling will be done as a continuous operation until final grade is reached. The paved road located on the fill will be sloped to the south and will function as a permanent diversion. The area adjacent to the roads and parking area will be graded to conduct runoff to the road culverts. Runoff water from the buildings will be guttered to the vegetated channels. The finished slope face to the north will not be back-bladed. The top 2 to 6 inches will be left in a loose and roughened condition. Plantings will be protected with mulch, as specified in the Vegetation Plan.

A minimum 15-ft undisturbed buffer zone will be maintained around the perimeter of the disturbed area (Note: This will reduce water and wind erosion, help contain sediment, reduce dust, and reduce final landscaping costs).

8. **Temporary Sediment Trap:** A small sediment trap will be constructed at the intersection of the existing road ditch and channel number 3 to protect the road ditch. Approximately 2 acres of disturbed area will drain into this trap. See pages F.18–F.19 for specifications.

9. **Sediment Fence:** A sediment fence will be constructed around the topsoil stockpile and along the channel berm adjacent to the deep cut area as necessary to prevent sediment from entering the channels. See pages F.19–F.20 for specifications.

10. **Grass-Lined Channel:** Grass-lined channels with temporary straw-net liners will be constructed around Buildings A and B to collect and convey site water to the project's sediment basin. See pages F.21–F.23 for specifications.

11. **Riprap-Lined and Paved Channels:** A riprap channel will be constructed in the old gully along the north side of the property starting in the northwest corner after all other construction is complete. This channel will replace the old gully as the principal outlet from the site. See pages F.24–F.25 for specifications.

12. **Construction Road Stabilization:** As soon as final grade is reached on the entrance road, the subgrade will be sloped to drain to the south and stabilized with a 6-inch course of NC DOT standard ABC stone. The parking area and its entrance road will also be stabilized with ABC stone to prevent erosion and dust during the construction of the buildings prior to paving. See pages F.25–F.26 for specifications.

13. **Outlet Stabilization Structure:** A riprap apron will be located at the outlet of the three culverts to prevent scour. See pages F.26–F.27 for specifications.

14. **Surface Roughening:** The 3:1 cut slopes will be lightly roughened by disking just prior to vegetating, and the surface 4 to 6 inches of the 2:1 fill slopes will be left in a loose condition and grooved on the contour. See page F.28 for specifications.

15. **Surface Stabilization:** Stabilization of the surface will be accomplished with vegetation and mulch as specified in the vegetation plan. One large oak tree, southwest of Building A, and a buffer area between the parking lot and Terri Road, will be preserved. Roadway and parking lot base courses will be installed as soon as finished grade is reached.

16. **Dust Control:** Dust control is not expected to be a problem due to the small area of exposure, the undisturbed perimeter of trees around the site, and the relatively short time of exposure (not to exceed 9 months). Should excessive dust be generated, it will be controlled by sprinkling.

Construction Schedule

1. Obtain plan approval and other applicable permits.
2. Flag the work limits and mark the oak tree and buffer area for protection.
3. Hold pre-construction conference at least one week prior to starting construction.
4. Install sediment basin as the first construction activity.
5. Install storm drain with block and gravel inlet protection at construction entrance/exit.
6. Install temporary gravel construction entrance/exit.
7. Construct temporary diversions above proposed building sites. Install level spreader and sediment trap and vegetate disturbed areas.
8. Complete site clearing except for the old gully channel in the northwest portion of the site. This area will be cleared during the last construction phase for the installation of the riprap liner.
9. Clear waste disposal area in the northeast corner of property, only as needed.
10. Rough grade site, stockpile topsoil, construct channels, install culverts and outlet protection, and install sediment fence as needed. Maintain diversions along top of fill slope daily. NOTE: A temporary diversion will be constructed across the middle of the graded area to reduce slope length and the bare areas mulched should grading be discontinued for more than 3 weeks.
11. Finish the slopes around buildings as soon as rough grading is complete. Leave the surface slightly roughened and vegetate and mulch immediately.
12. Complete final grading for roads and parking and stabilize with gravel.
13. Complete final grading for buildings.
14. Complete final grading of grounds, topsoil critical areas, and permanently vegetate, landscape, and mulch.
15. Install riprap outlet channel and extend riprap to the pipe outlet under the entrance road.
16. All erosion and sediment control practices will be inspected weekly and after rainfall events. Needed repairs will be made immediately.
17. After the site is stabilized, remove all temporary measures and install permanent vegetation on the disturbed areas.
18. Estimated time before final stabilization—9 months.

Maintenance Plan

1. All erosion and sediment control practices will be checked for stability and operation following every runoff-producing rainfall but in no case less than once every week. Any needed repairs will be made immediately to maintain all practices as designed and installed for their appropriate phase of the project.
2. The sediment basin will be cleaned out when the level of sediment reaches 2.0 ft below the top of the riser. Gravel will be cleaned or replaced when the sediment pool no longer drains properly.
3. Sediment will be removed from the sediment trap and block and gravel inlet protection device when storage capacity has been approximately 50% filled. Gravel will be cleaned or replaced when the sediment pool no longer drains properly.
4. Sediment will be removed from behind the sediment fence when it becomes about 0.5 ft deep at the fence. The sediment fence will be repaired as necessary to maintain a barrier.
5. All seeded areas will be fertilized, reseeded as necessary, and mulched according to specifications in the vegetative plan to maintain a vigorous, dense vegetative cover.

Vicinity Map

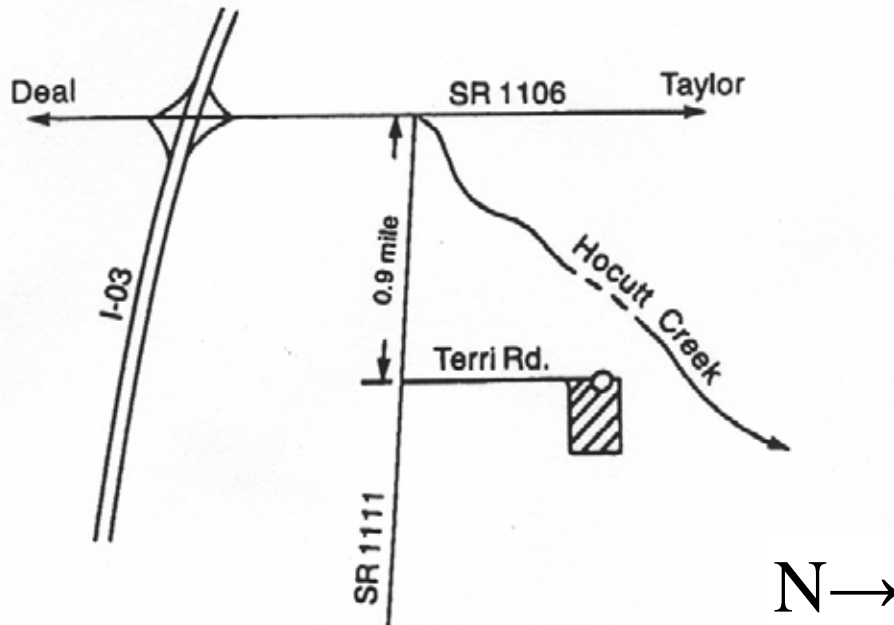

Site Topographic Map—Exhibit 1

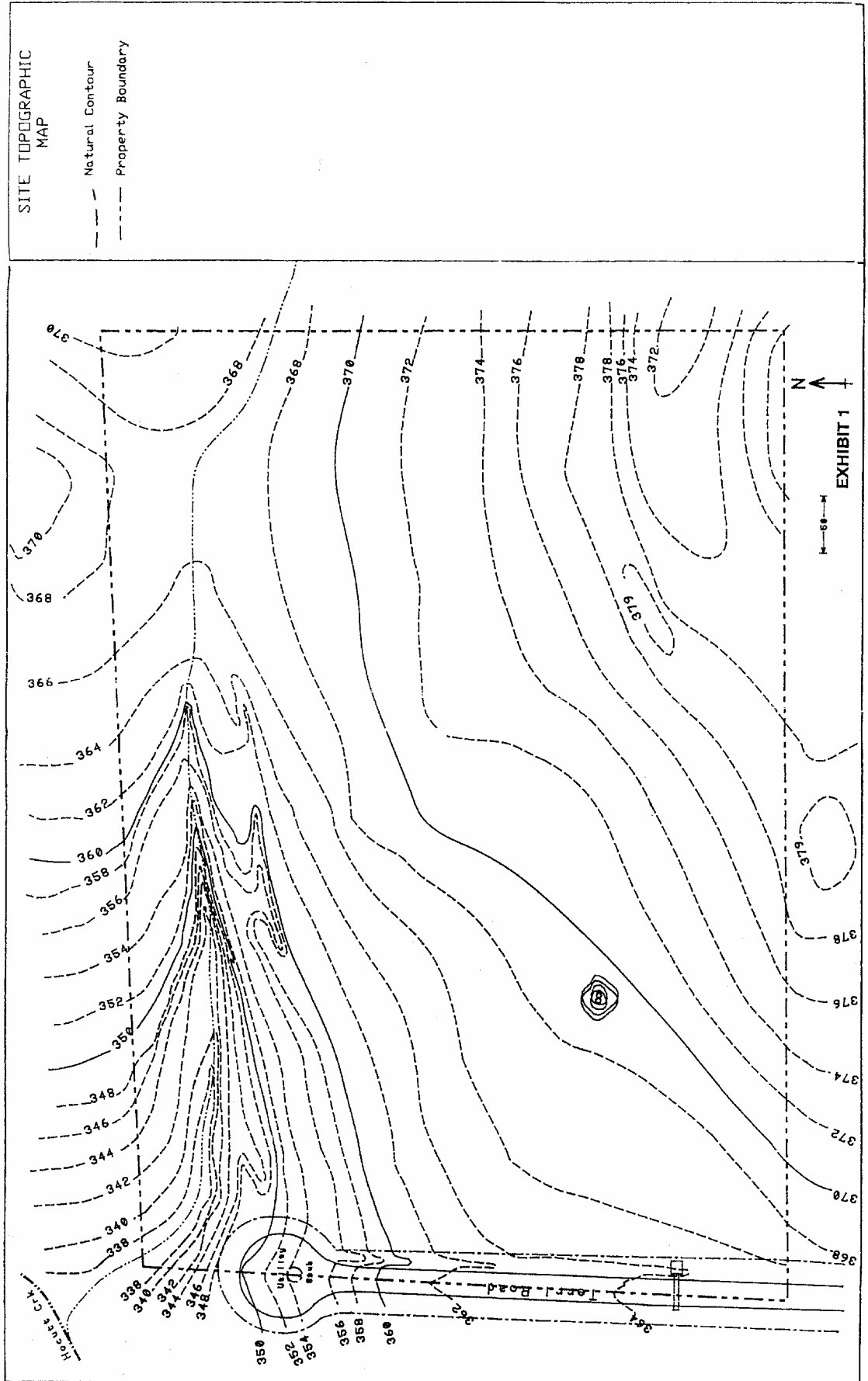

Site Development Map—Exhibit 2

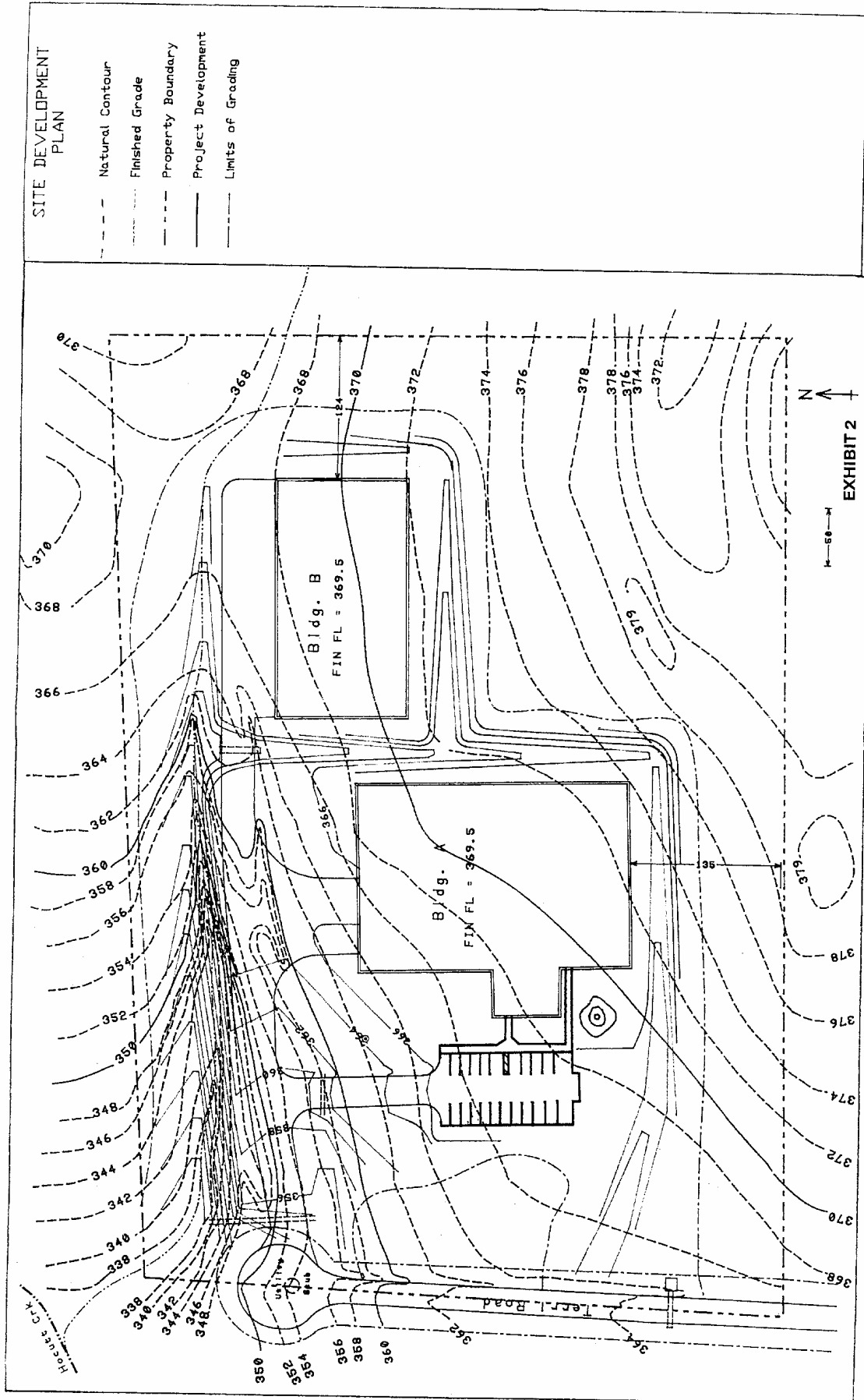

Site Erosion and Sediment Control Plan—Exhibit 3

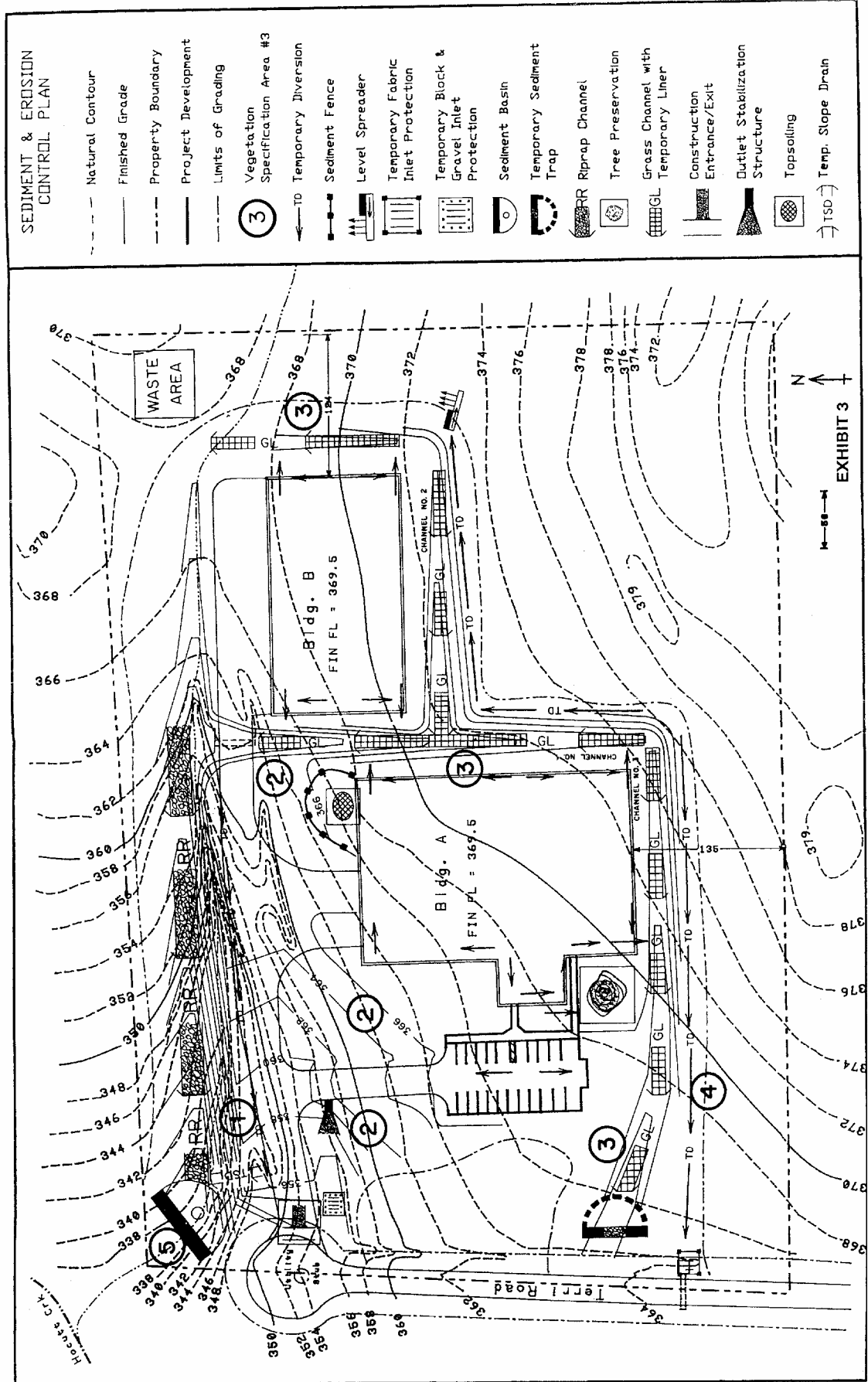

DETAIL DRAWINGS AND SPECIFICATIONS

1. SEDIMENT BASIN

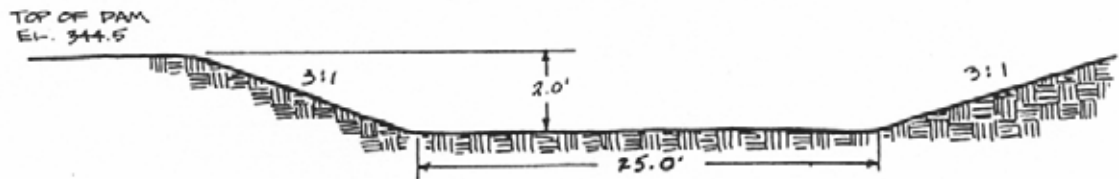
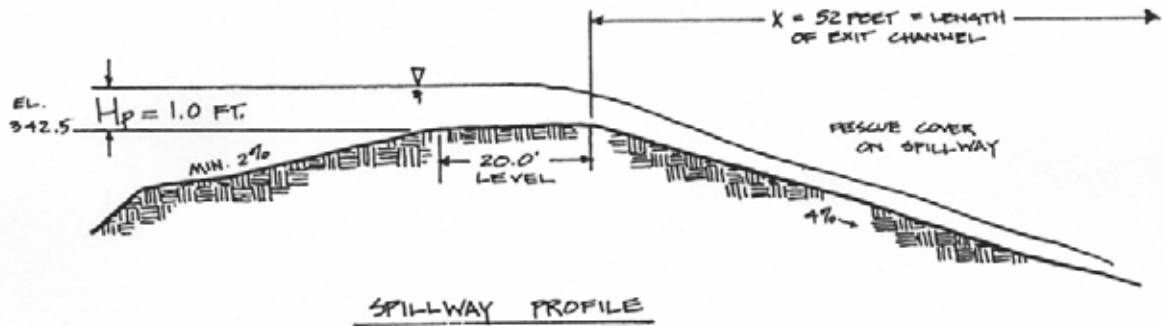
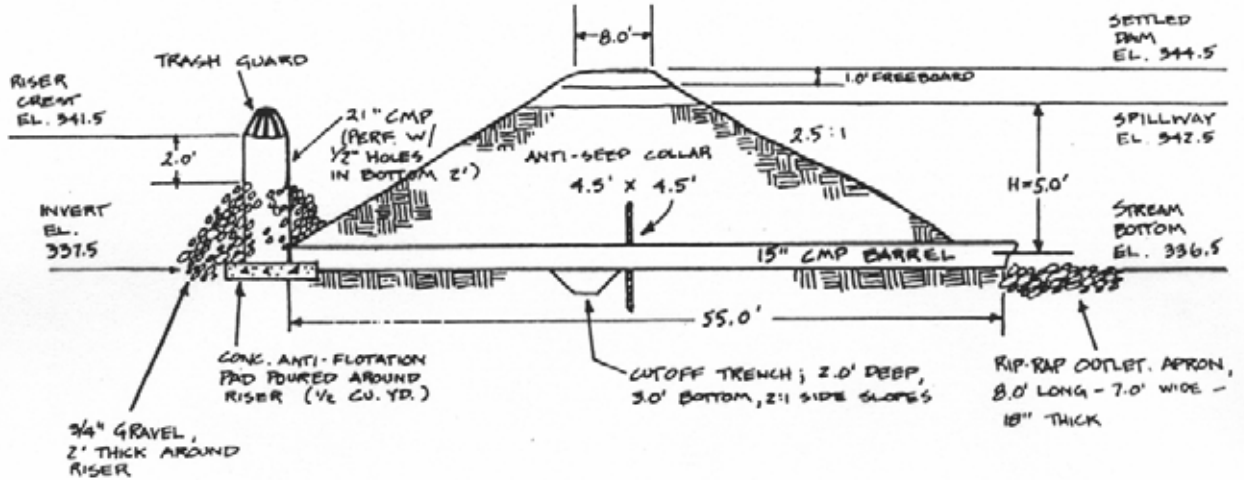

SPILLWAY: CROSS SECTION AT CONTROL SECTION

(1.) CONSTRUCTION SPECIFICATIONS :

1. CLEAR AND GROUND FOUNDATION FOR EMBANKMENT AND EXCAVATE THE AREA FOR THE RIPRAP OUTLET PAD. AREA TO BE 8.0' LONG, 7.0' WIDE AND 15' DEEP. (NOTE: THIS EXCAVATION WILL SERVE AS A SEDIMENT TRAP WHILE STRUCTURE IS BEING BUILT.)
2. EXCAVATE CUTOFF TRENCH ALONG EMBANKMENT CENTERLINE AND UP ABUTMENTS TO ELEVATION 344.0 AS SHOWN. KEEP TRENCH DRY WHEN BACKFILLING AND COMPACTING.
3. USE SEDIMENT POOL AREA AS SOURCE OF FILL MATERIAL FOR THE DAM. MATERIAL SHOULD BE CLEAN MINERAL SOIL, FREE OF ROOTS, WOODY MATERIAL, ROCKS OR OTHER OBJECTIONABLE MATERIAL. SCARIFY FOUNDATION AND PLACE FILL IN LAYERS NOT TO EXCEED 8" OVER THE ENTIRE LENGTH OF DAM. COMPACT BY HEAVY WHEEL EQUIPMENT. THE ENTIRE SURFACE OF EACH LAYER MUST BE TRAVERSED BY AT LEAST ONE WHEEL OF THE COMPACTION EQUIPMENT. THE FILL MATERIAL MUST BE MOIST BUT NOT SO WET THAT WATER CAN BE SQUEEZED FROM IT.
4. PERFORATE 24" CMP RISER WITH 1/2" HOLES SPACED 3" APART IN EACH OUTSIDE VALLEY TO WITHIN 2.0' OF THE TOP. SECURE TRASH RACK TO RISER TOP. MAXIMUM OPENING BETWEEN BARS OF RACK NOT TO EXCEED 3".
5. SECURELY ATTACH THE RISER TO THE BARREL AND ALL OTHER PIPE JOINTS WITH ROD AND LUG CONNECTOR BANDS WITH RUBBER GASKETS TO ASSURE WATER TIGHTNESS. PLACE THE BARREL AND RISER ON A SMOOTH, FIRM FOUNDATION. PLACE FILL AROUND THE PIPE IN 4" LAYERS AND HAND COMPACT. TAKE CARE NOT TO RAISE THE PIPE FROM FIRM CONTACT WITH ITS FOUNDATION WHEN COMPACTING UNDER PIPE HAUNCHES.
6. SECURE ONE STANDARD CORRUGATED METAL ANTI-SEEP COLLAR AROUND BARREL. MAKE SURE CONNECTION IS WATERTIGHT. HAND COMPACT AROUND ANTI-SEEP COLLAR.
7. PLACE A MINIMUM OF 2 FT. OF HAND COMPACTED BACKFILL OVER PIPE BEFORE CROSSING IT WITH CONSTRUCTION EQUIPMENT.
8. ANCHOR RISER IN PLACE WITH 1/2 YD³ CONCRETE PAD POURED AROUND RISER.
9. PLACE 3/4" GRAVEL (D.O.T. #5 WASHED STONE) OVER THE PERFORATED HOLES APPROXIMATELY 2" THICK.
10. INSTALL EMERGENCY SPILLWAY IN UNDISTURBED SOIL TO THE LINES AND GRADES SHOWN IN DRAWINGS.

11. PLACE CLASS A EROSION CONTROL STONE OVER FILTER FABRIC ON LEVEL GRADE FOR RIPRAP APRON AT PIPE OUTLET, TOP OF RIPRAP TO BE SAME ELEVATION AS OUTLET CHANNEL BOTTOM, NO OVERFALL.
12. CLEAR SEDIMENT POOL AREA TO ELEVATION 341.5 AFTER THE EMBANKMENT IS COMPLETE.
13. VEGETATE ALL DISTURBED AREAS (EXCEPT THE SEDIMENT POOL) IN ACCORDANCE WITH THE VEGETATIVE PLAN.
14. SEDIMENT TO BE REMOVED FROM BASIN WHEN THE LEVEL IS WITHIN 2.0' OF THE TOP OF THE RISER. (SAME LEVEL AS TOP OF GRAVEL.)

2. TEMPORARY GRAVEL CONSTRUCTION ENTRANCE

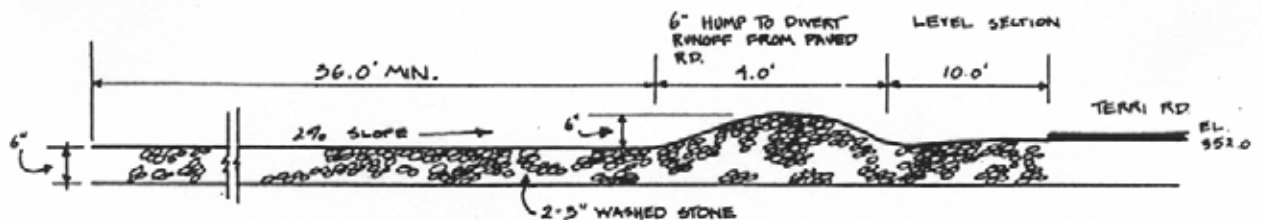

GRAVEL ENTRANCE/EXIT : WIDTH - 15.0' , FLARED TO 25.0' AT ROAD
 LENGTH - 50.0'
 GRADE - 2.0%

(2.) CONSTRUCTION SPECIFICATIONS

1. CLEAR THE ENTRANCE/EXIT AREA OF ALL VEGETATION, ROOTS, AND OTHER OBJECTIONABLE MATERIAL.
2. GRADE THE ROAD FOUNDATION SO THAT THE ENTRANCE/EXIT WILL HAVE A CROSS SLOPE TO THE SOUTH AND ALL RUNOFF WILL DRAIN TO THE BLOCK AND GRAVEL DROP INLET PROTECTION STRUCTURE.
3. PLACE STONE TO THE DIMENSIONS, GRADE AND ELEVATION SHOWN.
4. USE WASHED STONE 2" TO 3" IN SIZE.

NOTE : MAINTAIN THE GRAVEL PAD IN A CONDITION TO PREVENT MUD OR SEDIMENT FROM LEAVING THE SITE. SHOULD MUD BE TRACKED OR WASHED ONTO TERRI ROAD, IT MUST BE REMOVED IMMEDIATELY.

3. TEMPORARY BLOCK AND GRAVEL DROP INLET PROTECTION

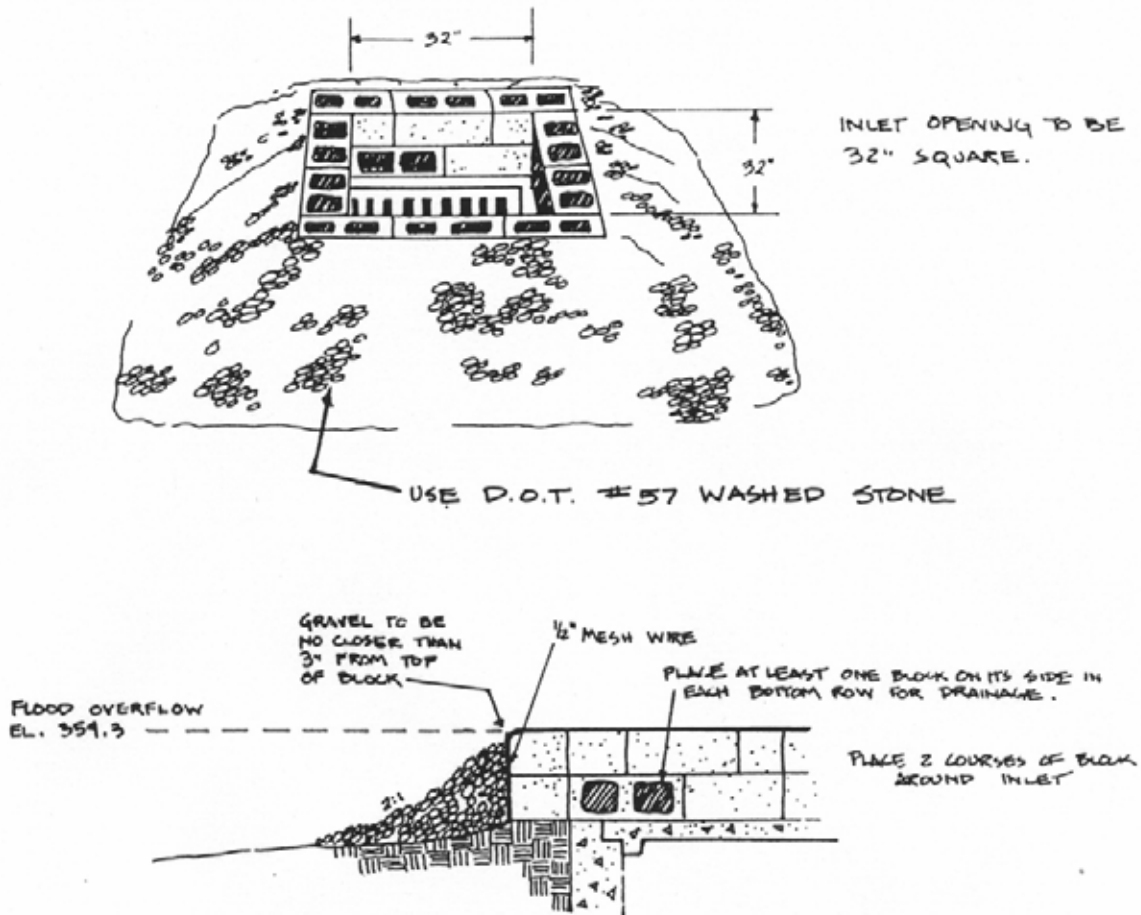

(3.) CONSTRUCTION SPECIFICATIONS

1. LAY CONCRETE BLOCKS ON FIRM, SMOOTH FOUNDATION EXCAVATED 3" BELOW STORM DRAIN TOP. PLACE BLOCKS AGAINST DRAIN INLET FOR LATERAL SUPPORT.
2. PLACE AT LEAST ONE CONCRETE BLOCK ON ITS SIDE IN EACH BOTTOM ROW OF BLOCKS.
3. PLACE WIRE MESH WITH 1/2" OPENINGS OVER ALL BLOCK OPENINGS USED FOR DRAINAGE.
4. USE D.O.T. #57 WASHED STONE TO REDUCE FLOW RATE BUT ALLOW DRAINAGE. PLACE STONE ON 2:1 SLOPE TO WITHIN 3" OF TOP OF BLOCK.
5. ANY SOIL LEFT EXPOSED BETWEEN THE BLOCK AND CONCRETE DRAIN INLET SHOULD BE FILLED WITH 3" DIAMETER STONE TO PREVENT WASHING WHEN WATER FLOWS OVER BLOCKS INTO DRAIN.

4. TEMPORARY DIVERSIONS

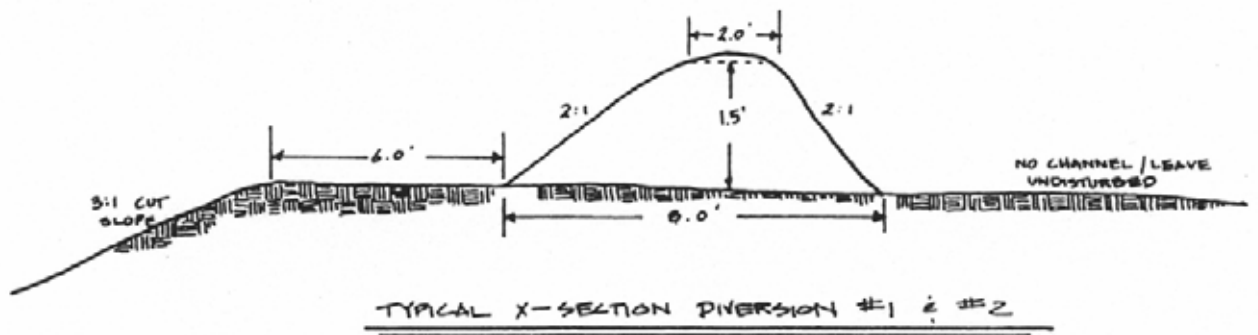

DIVERSION #1 - GRADE = 2%
LENGTH = 150'
DIVERSION #2 - GRADE = 0.5%
LENGTH = 100'

(A.) CONSTRUCTION SPECIFICATIONS

1. REMOVE ALL TREES, BRUSH & STUMPS FROM DIVERSION FOUNDATION.
2. CONSTRUCT RIDGE TO FULL DIMENSIONS SHOWN - ALLOW 10% FOR SETTLING.
3. COMPACT RIDGE BY WHEELS OF CONSTRUCTION EQUIPMENT.
4. ENSURE THAT THE TOP OF THE DIVERSION IS ON DESIGN GRADE OR HIGHER AT ALL POINTS.
5. SEED AND MULCH IMMEDIATELY AFTER CONSTRUCTION. SEE VEGETATIVE PLAN.

5. LEVEL SPREADER

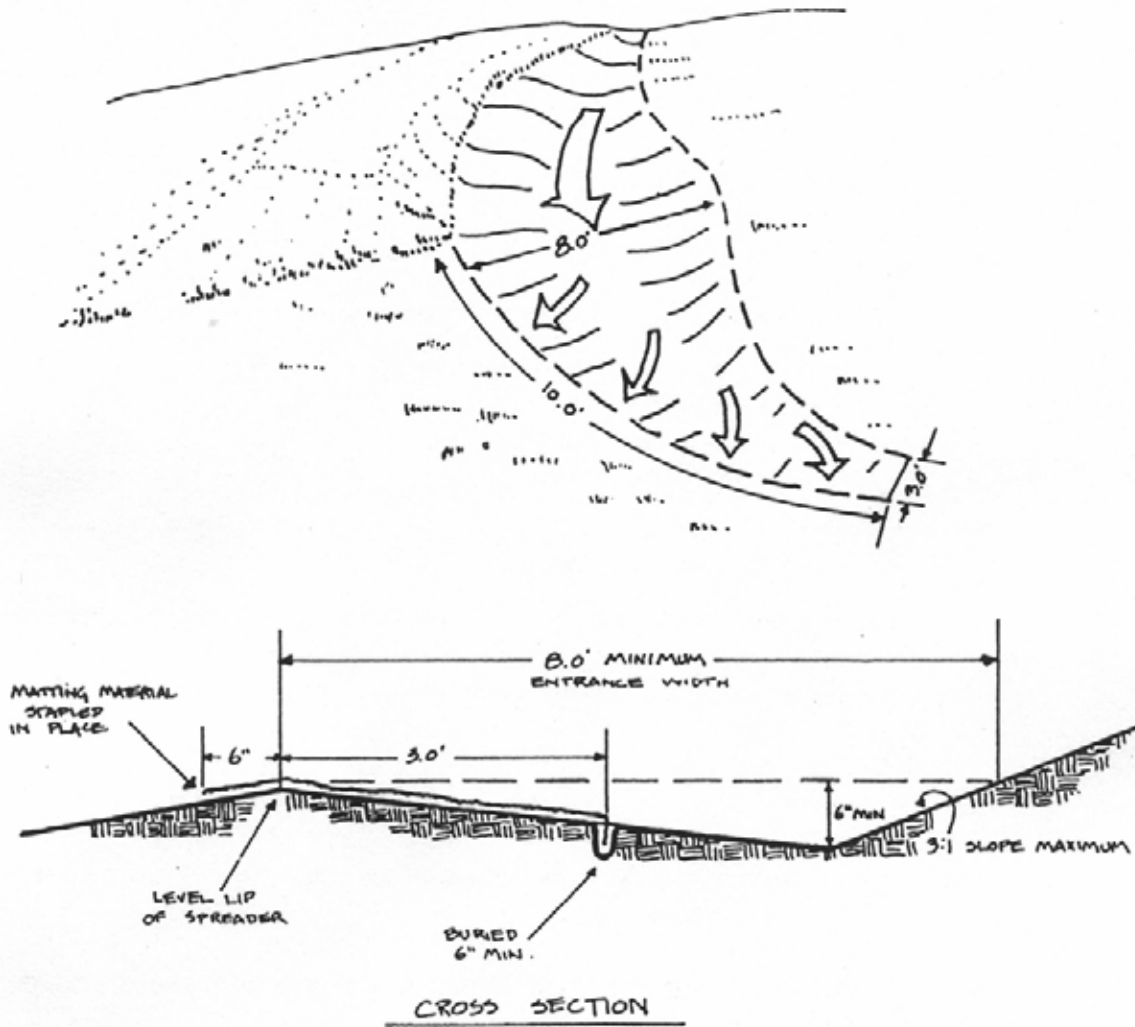

(5.) CONSTRUCTION SPECIFICATIONS

1. FIBERGLASS MATTING, 4.0 FT. WIDE, SHOULD EXTEND 6" OVER THE LEVEL LIP AND BE BURIED 6" DEEP AT THE LOWER EDGE.
2. ENSURE THAT THE SPREADER LIP IS LEVEL THROUGHOUT ITS LENGTH.
3. CONSTRUCT THE LEVEL SPREADER ON UNDISTURBED SOIL (NOT ON FILL.)
4. CONSTRUCT A TRANSITION SECTION FROM THE DIVERSION TO BLEND SMOOTHLY TO THE WIDTH AND DEPTH OF THE SPREADER.
5. IMMEDIATELY AFTER CONSTRUCTION, APPROPRIATELY SEED AND MULCH THE ENTIRE DISTURBED AREA OF THE SPREADER. SEE VEGETATIVE PLAN.

6. TREE PRESERVATION & PROTECTION

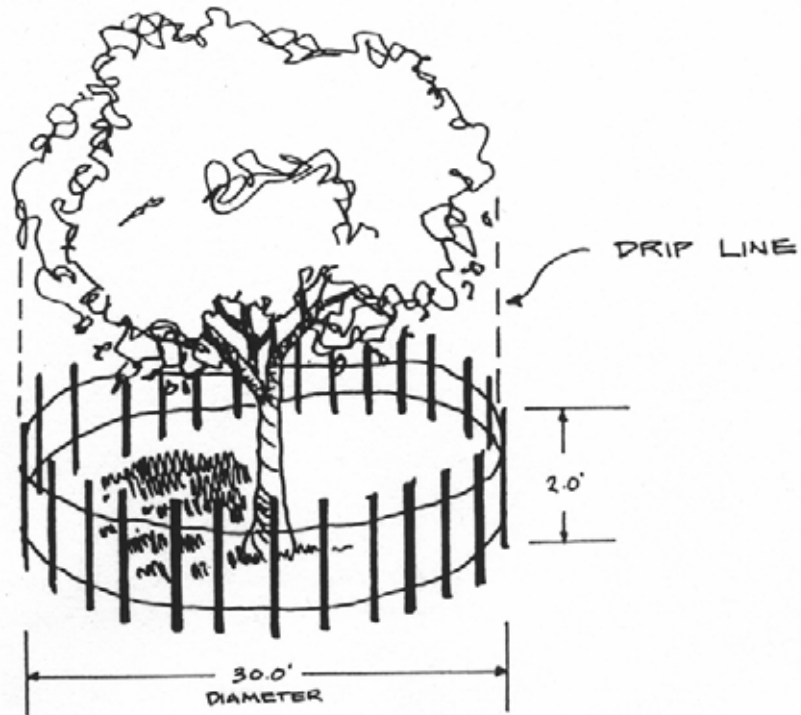

NOTE: SEDIMENT FENCE MATERIAL MAY BE USED TO BUILD FENCE.

- DRIVE STAKES FIRMLY INTO GROUND - AT LEAST 12"

7. LAND GRADING

1. FINISHED LAND SURFACES WILL BE GRADED AS SHOWN ON SITE DEVELOPMENT PLAN.
2. CUT SLOPES WILL BE 3:1 OR FLATTER FOR MAINTENANCE BY MOWING AND ROUGHENED FOR VEGETATIVE ESTABLISHMENT.
3. THE HIGH FILL SLOPE ON THE NORTH WILL NOT BE STEEPER THAN 2:1 AND ROUGHENED BY GROOVING ACROSS THE SLOPE.
4. TOPSOIL WILL BE REMOVED FROM AREAS TO BE GRADED AND FILLED AND IT WILL BE STOCKPILED IN LOCATIONS SHOWN.
5. AREAS TO BE FILLED WILL BE CLEARED AND GRUBBED.
6. FILL WILL BE PLACED IN LAYERS NOT TO EXCEED 9" AND COMPACTED AS REQUIRED IN THE SPECIFICATIONS FOR THE DEVELOPMENT PLAN (NOT A PART OF SEDIMENT CONTROL PLAN.)

7. FROZEN MATERIAL OR SOFT, HIGHLY COMPRESSIBLE MATERIAL WILL NOT BE USED AS FILL.
8. FILL WILL NOT BE PLACED ON A FROZEN SURFACE.
9. ROAD AND PARKING SURFACES WILL BE SLOPED AS SHOWN ON SITE DEVELOPMENT PLAN TO CONTROL RUNOFF.
10. LAND ADJOINING PAVED AREAS WILL BE SLOPED NO STEEPER THAN 6:1 AND GRADED TO DRAIN AS SHOWN.
11. SURFACE RUNOFF FROM BUILDINGS WILL BE COLLECTED IN GUTTERS AND PIPED TO CHANNELS 1, 2, 3 AND 4.
12. DIVERSIONS WILL BE INSTALLED ABOVE CUT SLOPES PRIOR TO LAND CLEARING AND GRADING.
13. A DIVERSION WILL BE MAINTAINED AT ALL TIMES ABOVE THE FILL SLOPE TO PREVENT OVERFLOW ON THIS STEEP AREA.
14. CUTTING AND FILLING WILL BE DONE AS A CONTINUOUS OPERATION UNTIL FINAL GRADE IS REACHED. SHOULD GRADING BE TEMPORARILY DISCONTINUED, A TEMPORARY DIVERSION WILL BE CONSTRUCTED ACROSS THE MIDDLE OF THE DISTURBED AREA TO BREAK UP THE LONG SLOPE TO THE NORTH.
15. AS SOON AS FINAL GRADES ARE REACHED THE GRADED AREAS WILL BE STABILIZED IN ACCORDANCE WITH THE VEGETATIVE PLAN.
16. AN UNDISTURBED AREA WILL BE LEFT AS A BUFFER AROUND THE ENTIRE GRADED SITE EXCEPT AT ROAD ENTRANCE AND CHANNEL #3 OUTLET.
17. WHEN THE DEVELOPED SITE HAS BEEN PROPERLY STABILIZED, ALL THE TEMPORARY SEDIMENT AND EROSION CONTROL MEASURES WILL BE REMOVED, THE DISTURBED AREA GRADED TO BLEND WITH THE SURROUNDING AREA, AND VEGETATED.

B. TEMPORARY SEDIMENT TRAP

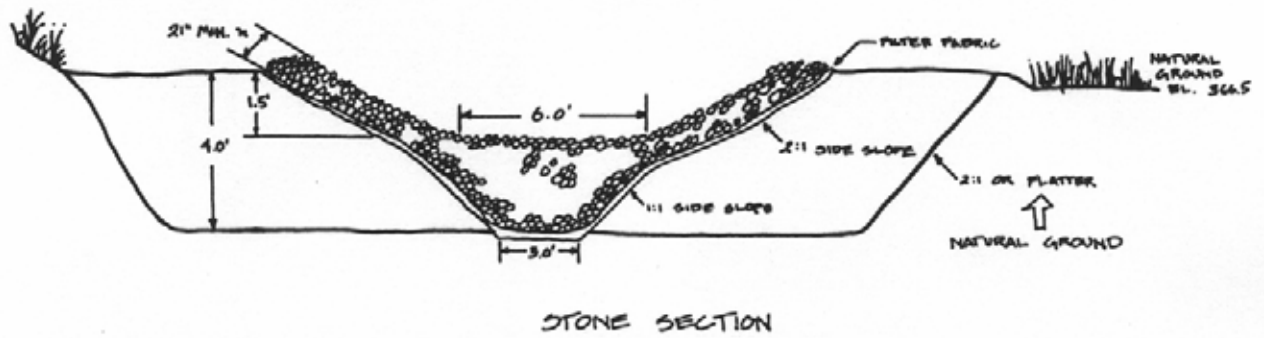
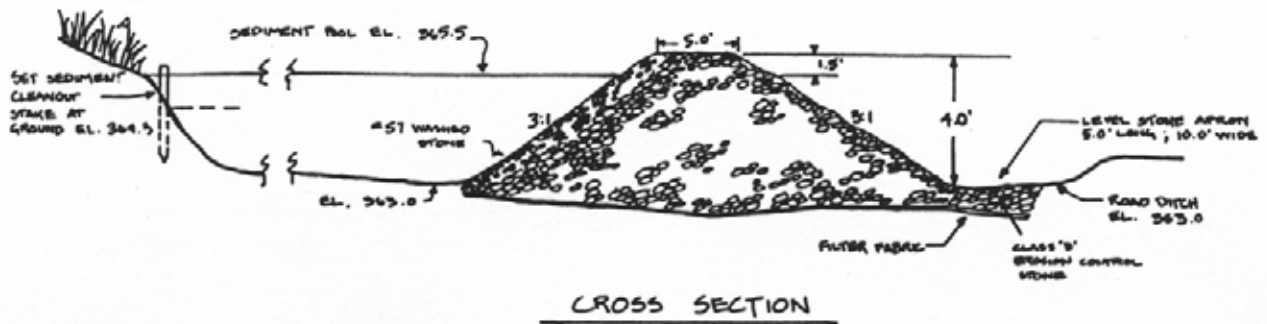

(B.) CONSTRUCTION SPECIFICATIONS

1. CLEAR, GRUB AND STRIP THE AREA UNDER THE EMBANKMENT OF ALL VEGETATION AND ROOT MAT.
2. CLEAR POND AREA BELOW ELEVATION 365.5
3. USE FILL MATERIAL FREE OF ROOTS, WOODY VEGETATION AND ORGANIC MATTER. PLACE FILL IN LIFTS NOT TO EXCEED 9" AND MACHINE COMPACT.
4. CONSTRUCT DAM AND STONE SPILLWAY TO DIMENSIONS, SLOPES AND ELEVATIONS SHOWN.
5. ENSURE THAT THE SPILLWAY CREST IS LEVEL AND AT LEAST 1.5' BELOW THE TOP OF THE DAM AT ALL POINTS.
6. STONE USED FOR SPILLWAY SECTION — CLASS "B" EROSION CONTROL STONE.

7. STONE USED ON INSIDE SPILLWAY FACE TO CONTROL DRAIN-AGE — P.O.T. # 57 WASHED STONE.
8. EXTEND STONE OUTLET SECTION TO VEGETATED ROAD DITCH ON ZERO GRADE WITH TOP ELEVATION OF STONE LEVEL WITH BOTTOM OF DRAIN.
9. ENSURE THAT THE TOP OF THE DAM AT ALL POINTS IS 0.5' ABOVE NATURAL SURROUNDING GROUND.
10. STABILIZE THE EMBANKMENT AND ALL DISTURBED AREA ABOVE THE SEDIMENT POOL AS SHOWN IN THE VEGETATION PLAN.

9. SEDIMENT FENCE

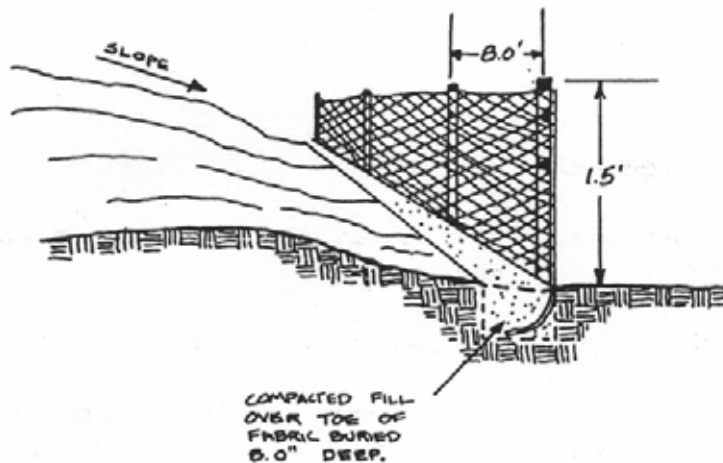

(9.) CONSTRUCTION SPECIFICATIONS

1. CONSTRUCT SEDIMENT FENCE ON LOW SIDE OF TOPSOIL STOCKPILE TO PREVENT SEDIMENT FROM BEING WASHED INTO THE DRAINAGE SYSTEM. FENCE TO EXTEND AROUND APPROXIMATELY 70% OF THE PERIMETER OF THE STOCKPILE.
2. LOCATE POSTS DOWNSLOPE OF FABRIC TO HELP SUPPORT FENCING.

3. BURY TOE OF FENCE APPROXIMATELY 8" DEEP TO PREVENT UNDERCUTTING.
4. WHEN JOINTS ARE NECESSARY, SECURELY FASTEN THE FABRIC AT A SUPPORT POST WITH OVERLAP TO THE NEXT POST.
5. FILTER FABRIC TO BE OF NYLON, POLYESTER, PROPYLENE OR ETHYLENE YARN WITH EXTRA STRENGTH - 50 LB/LIN. IN. (MINIMUM) - AND WITH A FLOW RATE OF AT LEAST 0.3 GAL./FT²/MINUTE. FABRIC SHOULD CONTAIN ULTRAVIOLET RAY INHIBITORS AND STABILIZERS.
6. POST TO BE 4" DIAMETER PINE WITH A MINIMUM LENGTH OF 4 FEET.

NOTE : IF HIGH CUT SLOPES ADJOINING CHANNELS 1, 2, AND 3 ARE NOT ADEQUATELY STABILIZED BEFORE CHANNEL IS CONSTRUCTED, A SEDIMENT FENCE SHOULD BE LOCATED ON THE CHANNEL BERM TO PREVENT SEDIMENT FROM ENTERING THE CHANNEL SYSTEM. THE FENCE SHOULD BE INSTALLED AS SHOWN ABOVE ALONG THE ENTIRE UNSTABLE AREA ADJOINING THE CHANNEL.

10. GRASS-LINED CHANNELS

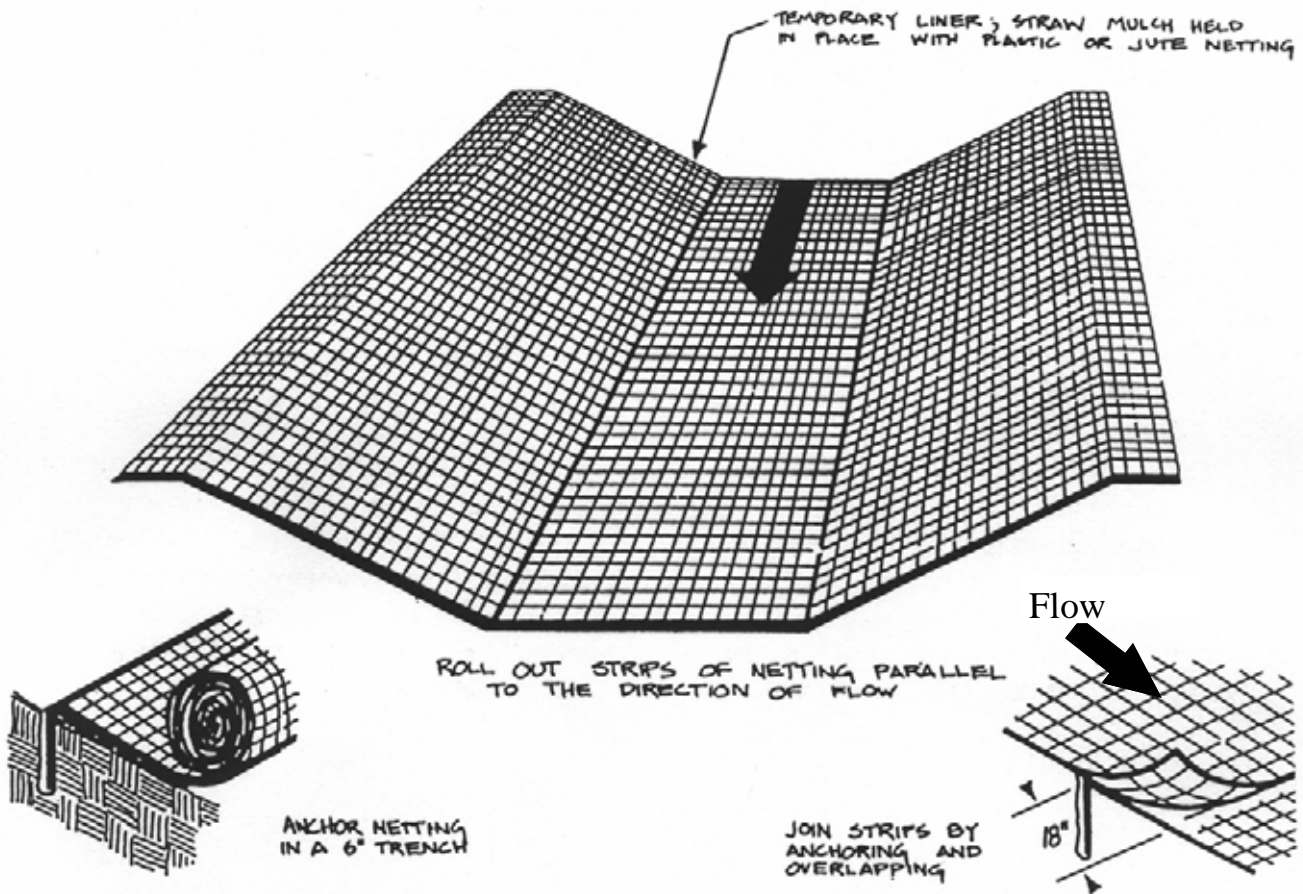

10. GRASS-LINED CHANNELS (CONT.)

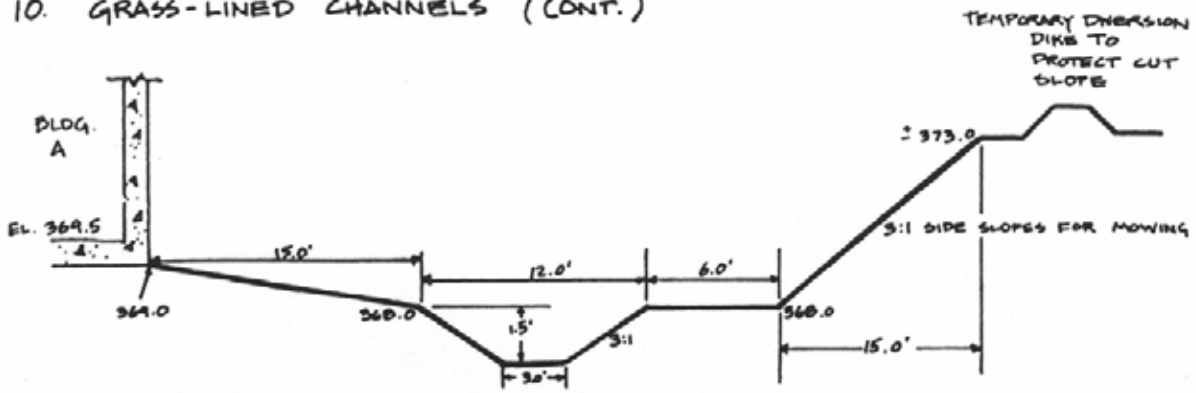

TYPICAL CROSS SECTION;

ALL CHANNELS (DEPTH AND TOP WIDTH WILL VARY BASED ON GROUND ELEVATION)

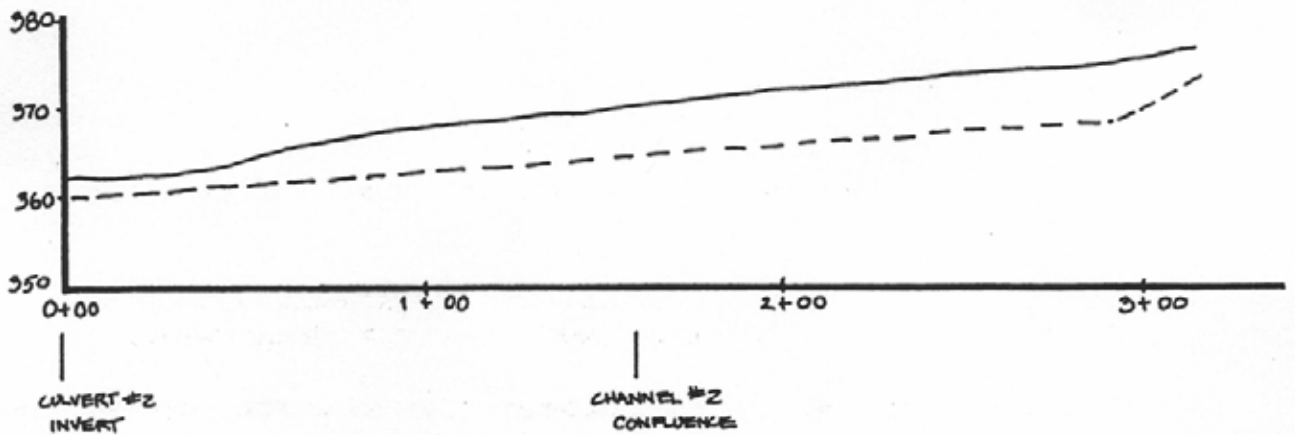

PROFILE - CHANNEL #1

CHANNEL #1

GRADE : 2%
 LENGTH : 360'
 BEGINNING GRADE EL : 359.5
 - AT OUTLET - INVERT OF CUVERT #2

CHANNEL #2

GRADE : 1.75%
 LENGTH : 230'
 BEGINNING GRADE EL : 362.7
 - AT INTERSECTION W/ CHANNEL #1

CHANNEL #3

GRADE : 1%
 LENGTH : 150'
 BEGINNING GRADE ELEVATION : 362.0
 - CUVERT INVERT UNDER TERRI ROAD

CHANNEL #4

GRADE : 1.17%
 LENGTH : 160'
 BEGINNING GRADE EL. : 364.8
 - AT OUTLET - EXISTING STAKE CHANNEL BOTTOM

(10.) CONSTRUCTION SPECIFICATIONS

1. EXCAVATE THE CHANNEL AND SHAPE IT TO AN EVEN CROSS-SECTION AS SHOWN. WHEN STAKING INDICATE A 0.2' OVERCUT AROUND THE CHANNEL PERIMETER FOR SILTING AND BULKING.
2. GRADE SOIL AWAY FROM CHANNEL SO THAT SURFACE WATER MAY ENTER FREELY.
3. APPLY LIME, FERTILIZER AND SEED TO THE CHANNEL AND ADJOINING AREAS IN ACCORDANCE WITH THE VEGETATION PLAN.
4. SPREAD STRAW MULCH AT THE RATE OF 100 LB/1000 FT².
5. HOLD MULCH IN PLACE IMMEDIATELY AFTER SPREADING WITH A PLASTIC NETTING INSTALLED AS SHOWN.
6. START LAYING THE NET FROM THE TOP OF THE UPSTREAM END OF THE CHANNEL AND UNROLL IT DOWN GRADE. DO NOT STRETCH NETTING.
7. BURY THE UPSLOPE END AND STAPLE THE NET EVERY 12" ACROSS THE TOP END, EVERY 3 FT. AROUND THE EDGES AND ACROSS THE NET SO THAT THE STRAW IS HELD CLOSELY AGAINST THE SOIL. HOWEVER, DO NOT STRETCH THE NETTING WHEN STAPLING.
8. NETTING STRIPS SHOULD BE JOINED TOGETHER ALONG THE SIDES WITH A 3" OVERLAP AND STAPLED TOGETHER.
9. TO JOIN ENDS OF STRIPS, INSERT THE NEW ROLL OF NET IN A TRENCH AS WITH UPSLOPE END AND OVERLAP IT 18" WITH THE PREVIOUSLY LAID UPPER ROLL. TURN UNDER 6" OF THE 18" OVERLAP AND STAPLE EVERY 12" ACROSS THE END.

II. RIPRAP CHANNEL

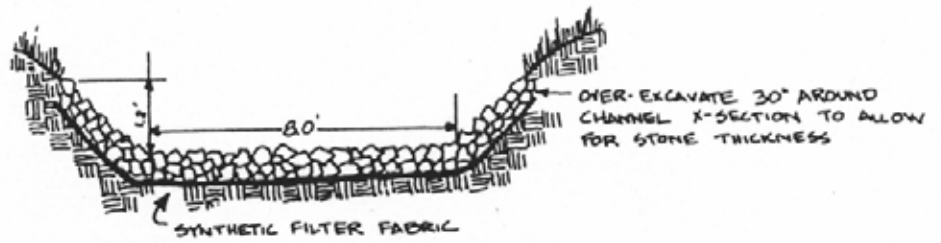

TYPICAL CROSS SECTION

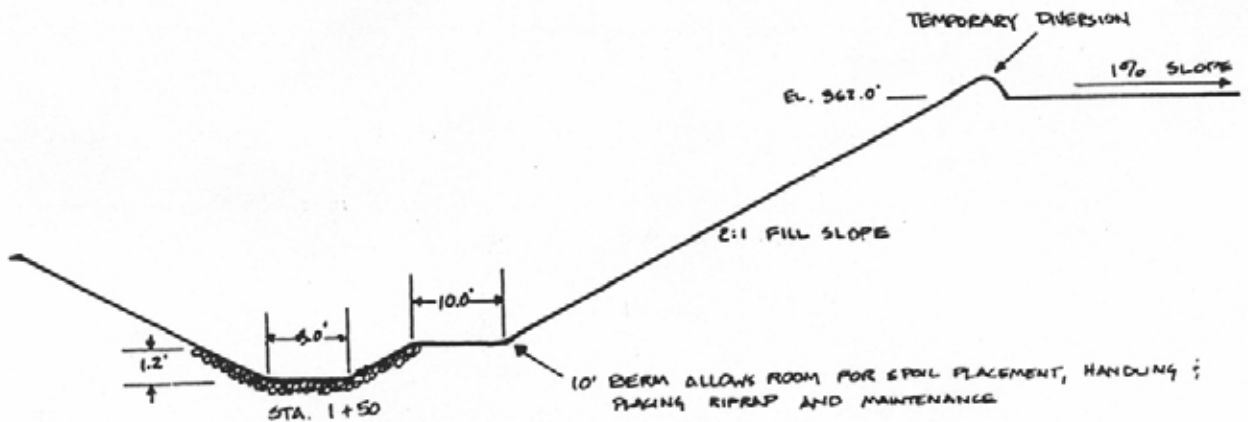

TYPICAL CROSS SECTION

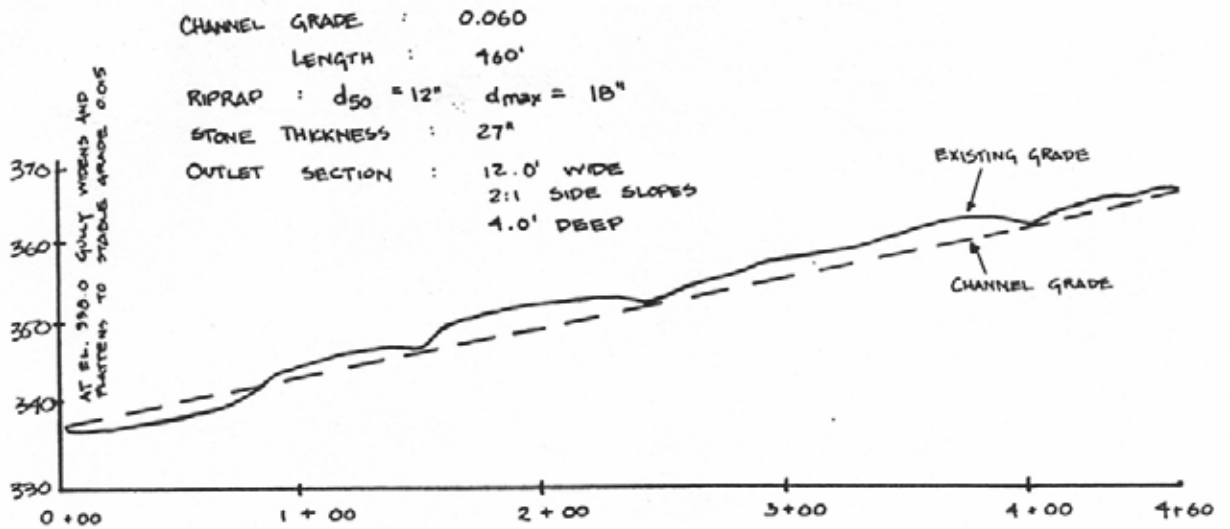

CHANNEL PROFILE

(11.) CONSTRUCTION SPECIFICATIONS

1. CLEAR THE FOUNDATION OF ALL TREES, STUMPS, AND ROOTS.
2. EXCAVATE THE BOTTOM AND SIDES OF THE CHANNEL 30" BELOW GRADE AT ALL POINTS TO ALLOW FOR THE PLACEMENT OF RIPRAP AS SHOWN IN THE TYPICAL X-SECTION.
3. INSTALL EXTRA STRENGTH FILTER FABRIC ON THE BOTTOM AND SIDES OF THE CHANNEL FOUNDATION, PLACING THE UPSTREAM FABRIC OVER THE DOWNSTREAM FABRIC WITH AT LEAST A 1.0' OVERLAP ON ALL JOINTS. THE FABRIC IS TO BE SECURELY HELD IN PLACE WITH METAL PINS.
4. PLACE RIPRAP EVENLY TO THE LINES AND GRADES SHOWN ON THE DRAWINGS AND STAKED IN THE FIELD. RIPRAP TO BE PLACED IMMEDIATELY FOLLOWING THE INSTALLATION OF THE FILTER FABRIC.
5. RIPRAP TO MEET SPECIFICATION FOR D.O.T. CLASS 2 RIPRAP.
6. VEGETATE ALL DISTURBED AREAS FOLLOWING SPECIFICATIONS SHOWN IN THE VEGETATIVE PLAN.

12. CONSTRUCTION ROAD STABILIZATION

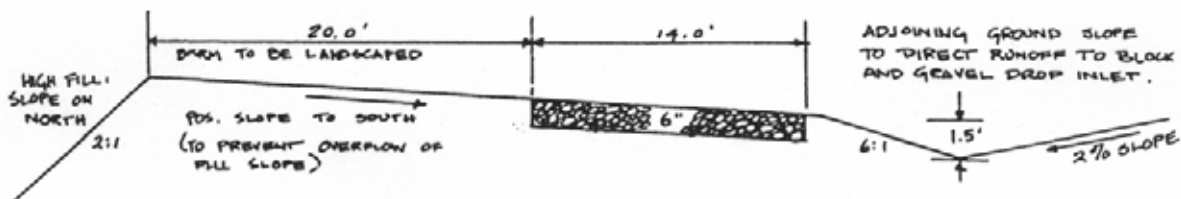

TYPICAL X-SECTION ENTRANCE ROAD

(TERRI RD. EAST TO CHANNEL #1)

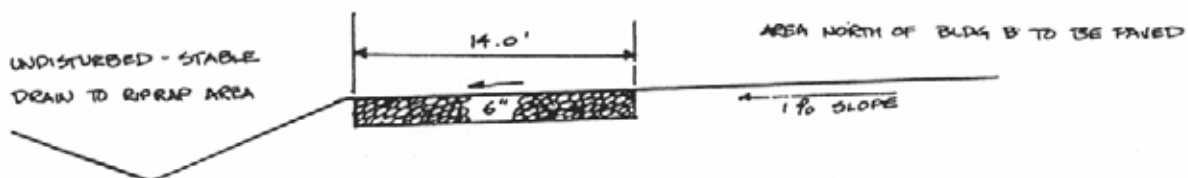

TYPICAL X-SECTION ENTRANCE ROAD

(FROM CHANNEL #1 EAST TO EAST END OF BLDG. B)

12. CONST. RD. STABILIZATION (CONT.)

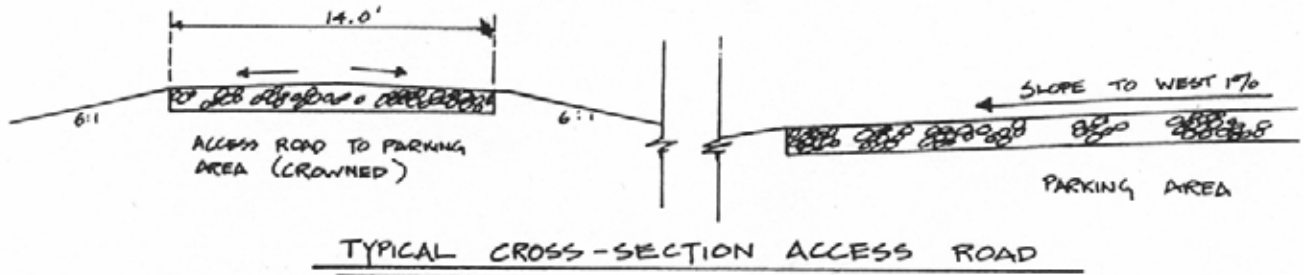

(12.) CONSTRUCTION SPECIFICATIONS

1. CLEAR ROAD BED AND PARKING AREAS OF ALL VEGETATION, ROOTS AND OTHER OBJECTIONABLE MATERIAL.
2. PROVIDE SURFACE DRAINAGE AS SHOWN.
3. SPREAD 6" COURSE OF R.O.T. "ABC" CRUSHED STONE EVENLY OVER THE FULL WIDTH OF ROAD AND PARKING AREA AND SMOOTH TO AVOID DEPRESSIONS.
4. VEGETATE ALL DISTURBED AREAS ADJOINING ROADS AND PARKING AS SOON AS GRADING IS COMPLETE IN ACCORDANCE WITH THE VEGETATION PLAN.

13. OUTLET STABILIZATION STRUCTURES

OUTLET PROTECTION FOR CULVERT #1

(FOR RIPRAP PROTECTION USE CLASS A OR CLASS B EROSION CONTROL STONE)

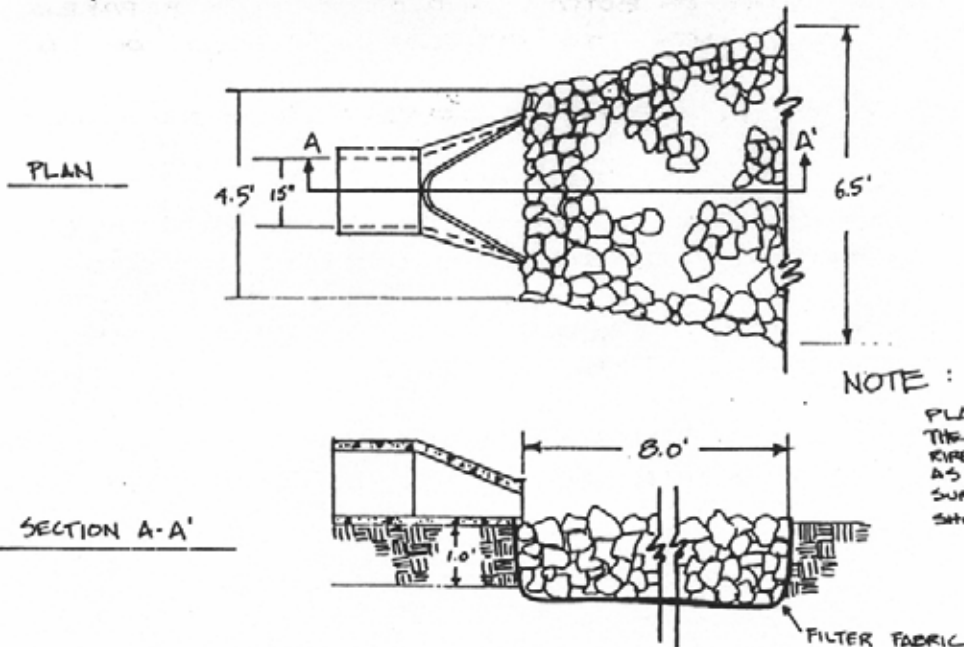

OUTLET PROTECTION FOR CULVERT #2

(LINE CHANNEL TO TOP OF BANKS FOR A DISTANCE OF 12.0' DOWNSTREAM. USE CLASS B EROSION CONTROL STONE.)

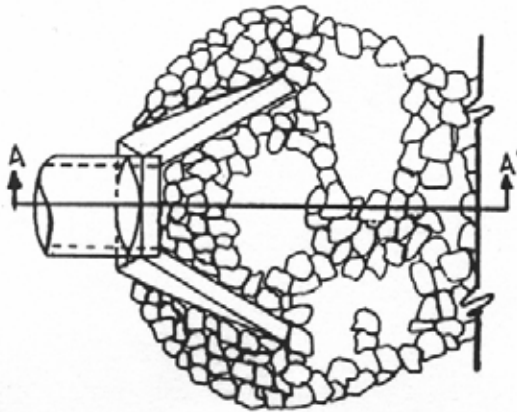

PLAN

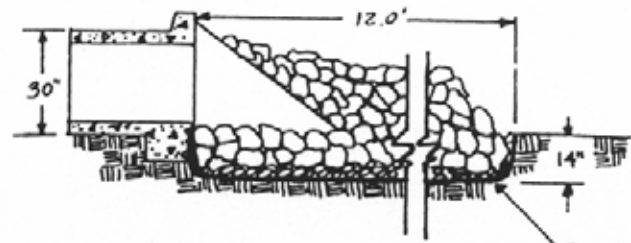

(PIPE OUTLET TO
WELL-DEFINED
CHANNEL)

FILTER
FABRIC

SECTION A-A'

NOTE: APRON TO BE PLACED LEVEL WITH THE TOP SURFACE OF RIPRAP AT SAME ELEVATION AS SIDES AND BOTTOM OF CHANNEL. NO CHANNEL OVERFALL OR RESTRICTION IN CHANNEL CROSS-SECTION SHOULD EXIST.

(13.) CONSTRUCTION SPECIFICATIONS

1. EXCAVATE BELOW CHANNEL OUTLET AND WIDEN CHANNEL TO THE REQUIRED RIPRAP THICKNESS FOR EACH APRON. FOUNDATION TO BE CUT TO ZERO GRADE AND SMOOTHED.
2. PLACE FILTER CLOTH ON BOTTOM AND SIDES OF PREPARED FOUNDATION. ALL JOINTS TO OVERLAP A MINIMUM OF 1.0'.
3. EXERCISE CARE IN RIPRAP PLACEMENT TO AVOID DAMAGE TO FILTER FABRIC.
4. PLACE RIPRAP ON ZERO GRADE - TOP OF RIPRAP TO BE LEVEL WITH EXISTING OUTLET - NO OVERFALL AT ENDS.
5. RIPRAP TO BE HARD, ANGULAR, WELL GRADED CLASS B EROSION CONTROL STONE.
6. IMMEDIATELY AFTER CONSTRUCTION STABILIZE ALL DISTURBED AREAS WITH VEGETATION AS SHOWN IN VEGETATIVE PLAN.

14. SURFACE ROUGHENING



A. - 2:1 FILL SLOPE

1. PLACE FILL IN LIFTS NOT TO EXCEED 9" AND COMPACT.
2. LEAVE FACE OF FILL SLOPE LOOSE AND UNCOMPACTED - 4-6" DEEP - DO NOT BACK BLADE IN FINAL GRADING.
3. GROOVE ON CONTOUR - GROOVES APPROX. 3" DEEP + 12" APART.
4. VEGETATE IMMEDIATELY AFTER GROOVING.

B. - 3:1 CUT SLOPE

1. GROOVE BY DISCING TO EVEN SURFACE FOR MAINTENANCE BY MOWING.
2. GROOVES APPROX. 1" - 2" DEEP AND 10" APART.
3. VEGETATE IMMEDIATELY AFTER DISCING. SEE VEGETATIVE PLAN.

VEGETATIVE PLAN

Seedbed Preparation (SP)

SP-1 Fill slopes 3:1 or steeper to be seeded with a hydraulic seeder (permanent seedings)

- 1) Leave the last 4-6 inches of fill loose and uncompacted, allowing rocks, roots, large clods and other debris to remain on the slope.
- 2) Roughen slope faces by making grooves 2-3 inches deep, perpendicular to the slope.
- 3) Spread lime evenly over slopes at rates recommended by soil tests.

SP-2 Fill slopes 3:1 or steeper (temporary seedings)

- 1) Leave a loose, uncompacted surface. Remove large clods, rocks, and debris which might hold netting above the surface.
- 2) Spread lime and fertilizer evenly at rates recommended by soil tests.
- 3) Incorporate amendments by roughening or grooving soil surface on the contour.

SP-3 High-maintenance turf

- 1) Remove rocks and debris that could interfere with tillage and the production of a uniform seedbed.
- 2) Apply lime and fertilizer at rates recommended by soil tests; spread evenly and incorporate to a depth of 2-4" with a farm disk or chisel plow.
- 3) Loosen the subgrade immediately prior to spreading topsoil by disking or scarifying to a depth of at least 2 inches.
- 4) Spread topsoil to a depth of 2-4 inches and cultipack.
- 5) Disk or harrow and rake to produce a uniform and well-pulverized surface.
- 6) Loosen surface just prior to applying seed.

SP-4 Gentle or flat slopes where topsoil is not used.

- 1) Remove rocks and debris.
- 2) Apply lime and fertilizer at rates recommended by soil tests; spread evenly and incorporate into the top 6" with a disk, chisel plow, or rotary tiller.
- 3) Break up large clods and rake into a loose, uniform seedbed.
- 4) Rake to loosen surface just prior to applying seed.

Seeding Methods (SM)

SM-1 Fill slopes steeper than 3:1 (permanent seedings)

Use hydraulic seeding equipment to apply seed and fertilizer, a wood fiber mulch at 45 lb/1,000 ft², and mulch tackifier.

SM-2 Gentle to flat slopes or temporary seedings

- 1) Broadcast seed at the recommended rate with a rotary seeder, drop spreader, or cultipacker seeder.
- 2) Rake seed into the soil and lightly pack to establish good contact.

Mulch (MU)

MU-1 Steep slopes (3:1 or greater)

In mid-summer, late fall or winter, apply 100 lb/1,000 ft² grain straw, cover with netting and staple to the slope. In spring or early fall use 45 lb/1,000 ft² wood fiber in a hydroseeder slurry.

MU-2 High-maintenance vegetation and temporary seedings

Apply 90 lb/1,000 ft² (4000 lb/acre) grain straw and tack with 0.1 gal/yd² asphalt (11 gal/1,000 ft²).

MU-3 Grass-lined channels

Install excelsior mat in the channel, extend up the channel banks to the highest calculated depth of flow, and secure according to manufacturer's specifications.

On channel shoulders, apply 100 lb/1,000 ft² grain straw.

Maintenance (MA)

MA-1 Refertilize in early spring the following year. Mow as desired.

MA-2 Keep mowed to a height of 2-4 inches. Fertilize with 40 lb/acre (1 lb/1,000 ft²) nitrogen in winter and again the following fall.

MA-3 Inspect and repair mulch and lining. Refertilize in late winter of the following year with 150 lb/acre 10-10-10 (3.5 lb/1,000 ft²). Mow regularly to a height of 3-4 inches.

MA-4 Topdress with 10-10-10 fertilizer if growth is not fully adequate.

MA-5 Topdress with 50 lb/acre (1 lb/1,000 ft²) nitrogen in March. If cover is needed through the following summer, overseed with 50 lb/acre Kobe lespedeza.

TABLE 1: VEGETATIVE PLAN¹

Area No.	Description	Season ³	Seeding Mixture		Seedbed Preparation	Seeding Method	Mulch	Maintenance	Notes
			Permanent lb/ac	Temporary lb/ac					
1	Steep slopes (3:1); low maintenance	Spring or fall	Tall fescue	100	SP-1	SM-1	MU-1	MA-1	Permanent mixture also used for low-maint. areas (4). Overseed winter plantings of rye with Kobe lespedeza in March if grading is not complete.
			Kobe lespedeza	10					
		Bahia grass	25						
		Rye grain	40						
2	High-maintenance turf	Summer	German millet	40	SP-2	SN-2	MA-5	MA-5	
		Winter	Rye grain	120					
		Spring	Rye grain	120	SP-3	SN-2	MU-2	MA-4	
		Summer	Kobe lespedeza	50					
3	Grassed channels with side slopes 3:1	Fall	Tall fescue blend	200	SP-4	SN-2	MU-3	MA-3	Tall fescue can be seeded in spring - increase rate to 250 lb/ac. Temp. seeding for fall is the same as for winter.
		Winter	Rye grain	120					
		Spring	Tall fescue	200	SP-4	SN-2	MU-3	MA-3	
		Summer	Rye grain	40					
4	Low-maintenance areas	Spring or Fall	Tall fescue	100	SP-4	SN-2	MU-2	MA-1	For temporary seeding in spring or fall see 5 below.
		Summer	Kobe lespedeza	10					
		Spring or Fall	Bahia grass	25	SP-4	SN-2	MU-2	MA-5	
		Summer	Rye grain	40					
5	Areas requiring cover for less than 1 year	Spring	Tall fescue	100	SP-4	SN-2	MU-2	MA-4	Treat temporary diversion as low-maintenance, permanent (area 4) Include topsoil stockpiles here
		Summer	Kobe lespedeza	10					
		Fall	Bermudagrass	15	SP-4	SN-2	MU-2	MA-5	
		Winter	German millet	10					
6	Areas requiring cover for less than 1 year	Spring	Rye grain	120	SP-4	SN-2	MU-2	MA-4	Treat temporary diversion as low-maintenance, permanent (area 4) Include topsoil stockpiles here
		Summer	Kobe lespedeza	50					
		Fall	German millet	40	SP-4	SN-2	MU-2	MA-5	
		Winter	Rye grain	120					

¹ Column entries for seedbed preparation, seeding method, mulch, and maintenance refer to Attachment 1.

² Area numbers are designated on map.

³ Spring (Feb. 1 - Apr. 15), Summer (Apr. 15 - Aug. 20), Fall (Aug. 20 - Oct. 25), Winter (Oct. 25 - Jan.).

APPENDIX G

EROSION AND SEDIMENT CONTROL PLAN REVIEW CHECKLIST

Project Name _____ Site Location _____

Applicant's Name & Address _____

General

A narrative statement shall be provided that describes the proposed project nature and purpose; the existing site conditions including topography, vegetation and drainage; adjacent and off-site areas affected by the project; description of the soils on the site and key properties; notations of critical areas such as steep slopes, channels or wetlands; the overall phasing, sequencing and stabilization plan; total disturbed area and those not to be disturbed.

I. Construction Drawings

Are the following items shown on the construction drawings:	<u>Yes</u>	<u>No</u>
1. Vicinity Map with scale and north arrow	_____	_____
2. Legend, scales, N arrow on plan view	_____	_____
3. Existing and proposed topography shown with contours labeled with spots elevations in critical areas	_____	_____
4. Scope of the plan noted in the Title Block	_____	_____
5. Limits of clearing and grading shown	_____	_____
6. Existing vegetation delineated	_____	_____
7. Soil boundaries shown on the plan view	_____	_____
8. Existing drainage patterns, 100 year floodplain and sub-areas shown	_____	_____
9. Existing and proposed development facilities/ improvements shown	_____	_____
10. Location of Erosion and Sediment control practices as phased with construction	_____	_____
11. Phasing plan with 5 acre threshold limits shown	_____	_____
12. Stockpile locations, staging areas and access points clearly defined	_____	_____
13. Street profiles, utility locations, property boundaries and, easement delineations shown	_____	_____

II. <u>Construction Notes & Details</u>	<u>Yes</u>	<u>No</u>
1. Specific sequence of operation given for each phase	___	___
2. Inspection and maintenance schedule shown for the specific practices	___	___
3. Design details show all dimensions and installation details necessary for construction	___	___
4. Implementation schedule for E&S practices is provided with removal criteria stated	___	___
5. Construction waste management plan incorporated in the notes	___	___
6. Site Inspections during construction are noted on the drawings and is in accordance with the General Permit for Stormwater Discharges from Construction Activities	___	___

III. Erosion & Sediment Control Practices

A. General	<u>Yes</u>	<u>No</u>
1. Practice meets purpose and design criteria	___	___
2. Standard details and construction notes are provided	___	___
3. Special timing of practice noted if applicable	___	___
4. Provisions for traffic crossings shown on the drawings where necessary	___	___

B. Practices Controlling Runoff	<u>Yes</u>	<u>No</u>
1. Positive drainage is maintained with contributing drainage area shown	___	___
2. Flow grades properly stabilized	___	___
3. Adequate outlet or discharge condition stabilized	___	___
4. Necessary dimensions, gradations, calculations, and materials shown	___	___

C. Practices Stabilizing Soil	<u>Yes</u>	<u>No</u>
1. Seeding rates and areas properly shown on the drawings	___	___
2. Mulch materials and rates specified on the drawings	___	___
3. Sequencing and timing provisions limit soil exposure to 14 days	___	___

C. Practices Stabilizing Soil (cont'd)	<u>Yes</u>	<u>No</u>
4. Rolled Erosion Control Products (RECP's) used are specified to location and appropriate weight/tie down	_____	_____
5. All soil seed bed preparation and amendments are specified on the drawings or in the specifications	_____	_____
6. The seeding dates are specified to cover the entire year for both temporary and permanent seedings	_____	_____
7. Maximum created slope is no steeper than 2 foot horizontal to 1 foot vertical with Cut and Fill slopes shown	_____	_____

D. Practices Controlling Sediment	<u>Yes</u>	<u>No</u>
1. Sediment traps/basins are sized in accordance with criteria	_____	_____
2. The contributing drainage area is shown on the grading plan	_____	_____
3. All scaled dimensions and volumes are shown on the plan	_____	_____
4. Maintenance requirements and clean out elevations established for all sediment control practices (50% capacity)	_____	_____
5. All access points of the project are shown to be stabilized	_____	_____
6. Storm drain inlets adequately protected	_____	_____
7. Silt fences are shown on the contour lines with no more than one quarter acre per 100 foot drainage to it	_____	_____
8. Temporary sediment traps being used at locations of future stormwater infiltration facilities	_____	_____

Additional Comments

Plan Reviewed By: _____ Date: _____

APPENDIX H

STATE POLLUTANT DISCHARGE ELIMINATION SYSTEM FOR CONSTRUCTION ACTIVITIES CONSTRUCTION SITE LOG BOOK

Table of Contents

- I. Pre-Construction Meeting Documents
 - a. Preamble to Site Assessment and Inspections
 - b. Operator's Certification
 - c. Qualified Professional's Credentials & Certification
 - d. Pre-Construction Site Assessment Checklist

- II. Construction Duration Inspections
 - a. Directions
 - b. Modification to the SWPPP

- III. Monthly Summary Reports

- IV. Monitoring, Reporting, and Three-Month Status Reports
 - a. Operator's Compliance Response Form

Properly completing forms such as those contained in Appendix H meet the inspection requirement of NYS-DEC SPDES GP for Construction Activities. Completed forms shall be kept on site at all times and made available to authorities upon request.

I. PRE-CONSTRUCTION MEETING DOCUMENTS

Project Name _____
Permit No. _____ **Date of Authorization** _____
Name of Operator _____
Prime Contractor _____

a. Preamble to Site Assessment and Inspections

The Following Information To Be Read By All Person's Involved in The Construction of Stormwater Related Activities:

The Operator agrees to have a qualified professional¹ conduct an assessment of the site prior to the commencement of construction² and certify in this inspection report that the appropriate erosion and sediment controls described in the SWPPP have been adequately installed or implemented to ensure overall preparedness of the site for the commencement of construction.

Prior to the commencement of construction, the Operator shall certify in this site logbook that the SWPPP has been prepared in accordance with the State's standards and meets all Federal, State and local erosion and sediment control requirements.

When construction starts, site inspections shall be conducted by the qualified professional at least every 7 calendar days and within 24 hours of the end of a storm event of 0.5 inches or greater (Construction Duration Inspections). The Operator shall maintain a record of all inspection reports in this site logbook. The site logbook shall be maintained on site and be made available to the permitting authorities upon request. The Operator shall post at the site, in a publicly accessible location, a summary of the site inspection activities on a monthly basis (Monthly Summary Report).

The operator shall also prepare a written summary of compliance with this general permit at a minimum frequency of every three months (Operator's Compliance Response Form), while coverage exists. The summary should address the status of achieving each component of the SWPPP.

Prior to filing the Notice of Termination or the end of permit term, the Operator shall have a qualified professional perform a final site inspection. The qualified professional shall certify that the site has undergone final stabilization³ using either vegetative or structural stabilization methods and that all temporary erosion and sediment controls (such as silt fencing) not needed for long-term erosion control have been removed. In addition, the Operator must identify and certify that all permanent structures described in the SWPPP have been constructed and provide the owner(s) with an operation and maintenance plan that ensures the structure(s) continuously functions as designed.

1 "Qualified Professional means a person knowledgeable in the principles and practice of erosion and sediment controls, such as a Certified Professional in Erosion and Sediment Control (CPESC), soil scientist, licensed engineer or someone working under the direction and supervision of a licensed engineer (person must have experience in the principles and practices of erosion and sediment control).

2 "Commencement of construction" means the initial removal of vegetation and disturbance of soils associated with clearing, grading or excavating activities or other construction activities.

3 "Final stabilization" means that all soil-disturbing activities at the site have been completed and a uniform, perennial vegetative cover with a density of eighty (80) percent has been established or equivalent stabilization measures (such as the use of mulches or geotextiles) have been employed on all unpaved areas and areas not covered by permanent structures.

b. Operators Certification

"I certify under penalty of law that this document and all attachments were prepared under my direction or supervision in accordance with a system designed to assure that qualified personnel properly gathered and evaluated the information submitted. Based on my inquiry of the person or persons who manage the system, or those persons directly responsible for gathering the information, the information submitted is, to the best of my knowledge and belief, true, accurate, and complete. Further, I hereby certify that the SWPPP meets all Federal, State, and local erosion and sediment control requirements. I am aware that false statements made herein are punishable as a class A misdemeanor pursuant to Section 210.45 of the Penal Law.

Name (please print): _____

Title _____ **Date:** _____

Address: _____

Phone: _____ **Email:** _____

Signature: _____

c. Qualified Professional's Credentials & Certification

"I hereby certify that I meet the criteria set forth in the General Permit to conduct site inspections for this project and that the appropriate erosion and sediment controls described in the SWPPP and as described in the following Pre-construction Site Assessment Checklist have been adequately installed or implemented, ensuring the overall preparedness of this site for the commencement of construction."

Name (please print): _____

Title _____ **Date:** _____

Address: _____

Phone: _____ **Email:** _____

Signature: _____

d. Pre-construction Site Assessment Checklist

(NOTE: Provide comments below as necessary)

1. Notice of Intent, SWPPP, and Contractors Certification:

Yes No NA

- Has a Notice of Intent been filed with the NYS Department of Conservation?
- Is the SWPPP on-site? Where? _____
- Is the Plan current? What is the latest revision date? _____
- Is a copy of the NOI (with brief description) onsite? Where? _____
- Have all contractors involved with stormwater related activities signed a contractor's certification?

2. Resource Protection

Yes No NA

- Are construction limits clearly flagged or fenced?
- Important trees and associated rooting zones, on-site septic system absorption fields, existing vegetated areas suitable for filter strips, especially in perimeter areas, have been flagged for protection.
- Creek crossings installed prior to land-disturbing activity, including clearing and blasting.

3. Surface Water Protection

Yes No NA

- Clean stormwater runoff has been diverted from areas to be disturbed.
- Bodies of water located either on site or in the vicinity of the site have been identified and protected.
- Appropriate practices to protect on-site or downstream surface water are installed.
- Are clearing and grading operations divided into areas <5 acres?

4. Stabilized Construction Entrance

Yes No NA

- A temporary construction entrance to capture mud and debris from construction vehicles before they enter the public highway has been installed.
- Other access areas (entrances, construction routes, equipment parking areas) are stabilized immediately as work takes place with gravel or other cover.
- Sediment tracked onto public streets is removed or cleaned on a regular basis.

5. Perimeter Sediment Controls

Yes No NA

- Silt fence material and installation comply with the standard drawing and specifications.
- Silt fences are installed at appropriate spacing intervals
- Sediment/detention basin was installed as first land disturbing activity.
- Sediment traps and barriers are installed.

6. Pollution Prevention for Waste and Hazardous Materials

Yes No NA

- The Operator or designated representative has been assigned to implement the spill prevention avoidance and response plan.
- The plan is contained in the SWPPP on page _____
- Appropriate materials to control spills are onsite. Where? _____

II. CONSTRUCTION DURATION INSPECTIONS

a. Directions:

Inspection Forms will be filled out during the entire construction phase of the project.

Required Elements:

- (1) On a site map, indicate the extent of all disturbed site areas and drainage pathways. Indicate site areas that are expected to undergo initial disturbance or significant site work within the next 14-day period;
- (2) Indicate on a site map all areas of the site that have undergone temporary or permanent stabilization;
- (3) Indicate all disturbed site areas that have not undergone active site work during the previous 14-day period;
- (4) Inspect all sediment control practices and record the approximate degree of sediment accumulation as a percentage of sediment storage volume (for example, 10 percent, 20 percent, 50 percent);
- (5) Inspect all erosion and sediment control practices and record all maintenance requirements such as verifying the integrity of barrier or diversion systems (earthen berms or silt fencing) and containment systems (sediment basins and sediment traps). Identify any evidence of rill or gully erosion occurring on slopes and any loss of stabilizing vegetation or seeding/mulching. Document any excessive deposition of sediment or ponding water along barrier or diversion systems. Record the depth of sediment within containment structures, any erosion near outlet and overflow structures, and verify the ability of rock filters around perforated riser pipes to pass water; and
- (6) Immediately report to the Operator any deficiencies that are identified with the implementation of the SWPPP.

SITE PLAN/SKETCH

Inspector (print name)

Date of Inspection

Qualified Professional (print name)

Qualified Professional Signature

The above signed acknowledges that, to the best of his/her knowledge, all information provided on the forms is accurate and complete.

Maintaining Water Quality

Yes No NA

- Is there an increase in turbidity causing a substantial visible contrast to natural conditions?
- Is there residue from oil and floating substances, visible oil film, or globules or grease?
- All disturbance is within the limits of the approved plans.
- Have receiving lake/bay, stream, and/or wetland been impacted by silt from project?

Housekeeping

1. General Site Conditions

Yes No NA

- Is construction site litter and debris appropriately managed?
- Are facilities and equipment necessary for implementation of erosion and sediment control in working order and/or properly maintained?
- Is construction impacting the adjacent property?
- Is dust adequately controlled?

2. Temporary Stream Crossing

Yes No NA

- Maximum diameter pipes necessary to span creek without dredging are installed.
- Installed non-woven geotextile fabric beneath approaches.
- Is fill composed of aggregate (no earth or soil)?
- Rock on approaches is clean enough to remove mud from vehicles & prevent sediment from entering stream during high flow.

Runoff Control Practices

1. Excavation Dewatering

Yes No NA

- Upstream and downstream berms (sandbags, inflatable dams, etc.) are installed per plan.
- Clean water from upstream pool is being pumped to the downstream pool.
- Sediment laden water from work area is being discharged to a silt-trapping device.
- Constructed upstream berm with one-foot minimum freeboard.

2. Level Spreader

Yes No NA

- Installed per plan.
- Constructed on undisturbed soil, not on fill, receiving only clear, non-sediment laden flow.
- Flow sheets out of level spreader without erosion on downstream edge.

3. Interceptor Dikes and Swales

Yes No NA

- Installed per plan with minimum side slopes 2H:1V or flatter.
- Stabilized by geotextile fabric, seed, or mulch with no erosion occurring.
- Sediment-laden runoff directed to sediment trapping structure

CONSTRUCTION DURATION INSPECTIONS
Runoff Control Practices (continued)

4. Stone Check Dam

Yes No NA

- Is channel stable? (flow is not eroding soil underneath or around the structure).
- Check is in good condition (rocks in place and no permanent pools behind the structure).
- Has accumulated sediment been removed?.

5. Rock Outlet Protection

Yes No NA

- Installed per plan.
- Installed concurrently with pipe installation.

Soil Stabilization

1. Topsoil and Spoil Stockpiles

Yes No NA

- Stockpiles are stabilized with vegetation and/or mulch.
- Sediment control is installed at the toe of the slope.

2. Revegetation

Yes No NA

- Temporary seedings and mulch have been applied to idle areas.
- 4 inches minimum of topsoil has been applied under permanent seedings

Sediment Control Practices

1. Stabilized Construction Entrance

Yes No NA

- Stone is clean enough to effectively remove mud from vehicles.
- Installed per standards and specifications?
- Does all traffic use the stabilized entrance to enter and leave site?
- Is adequate drainage provided to prevent ponding at entrance?

2. Silt Fence

Yes No NA

- Installed on Contour, 10 feet from toe of slope (not across conveyance channels).
 - Joints constructed by wrapping the two ends together for continuous support.
 - Fabric buried 6 inches minimum.
 - Posts are stable, fabric is tight and without rips or frayed areas.
- Sediment accumulation is ___% of design capacity.

Sediment Control Practices (continued)

3. Storm Drain Inlet Protection (Use for Stone & Block; Filter Fabric; Curb; or, Excavated practices)

Yes No NA

- Installed concrete blocks lengthwise so open ends face outward, not upward.
 - Placed wire screen between No. 3 crushed stone and concrete blocks.
 - Drainage area is 1acre or less.
 - Excavated area is 900 cubic feet.
 - Excavated side slopes should be 2:1.
 - 2" x 4" frame is constructed and structurally sound.
 - Posts 3-foot maximum spacing between posts.
 - Fabric is embedded 1 to 1.5 feet below ground and secured to frame/posts with staples at max 8-inch spacing.
 - Posts are stable, fabric is tight and without rips or frayed areas.
- Sediment accumulation ___% of design capacity.

4. Temporary Sediment Trap

Yes No NA

- Outlet structure is constructed per the approved plan or drawing.
 - Geotextile fabric has been placed beneath rock fill.
- Sediment accumulation is ___% of design capacity.

5. Temporary Sediment Basin

Yes No NA

- Basin and outlet structure constructed per the approved plan.
 - Basin side slopes are stabilized with seed/mulch.
 - Drainage structure flushed and basin surface restored upon removal of sediment basin facility.
- Sediment accumulation is ___% of design capacity.

Note: Not all erosion and sediment control practices are included in this listing. Add additional pages to this list as required by site specific design.
 Construction inspection checklists for post-development stormwater management practices can be found in Appendix F of the New York Stormwater Management Design Manual.

Page Intentionally Left Blank

DIRECTORIES

CONTENTS

	<u>Page</u>
Natural Resources Conservation Service Field Offices in NY.....	1
County Soil & Water Conservation District Offices in NY.....	3
New York State Department of Environmental Conservation Regional Offices, Division of Water.....	5
New York City Department of Environmental Protection.....	6
U.S. Army Corps of Engineers.....	6
Delaware River Basin Commission.....	6
Susquehanna River Basin Commission.....	6
Regional Planning Councils.....	6
County Cornell Cooperative Extension Offices in NY.....	7

Note: These directories are current as of publication date and are subject to change.

Natural Resources Conservation Service Field Offices in NY

<u>COUNTY</u>	<u>OFFICE LOCATION</u>	<u>PHONE</u>
Albany	Voorheesville Service Center, 24 Martin Road, Voorheesville, NY 12186	518-765-3560
Allegany	Belmont Service Center, 5425 County Road 48, Belmont, NY 14813	585-268-5133
Broome	Binghamton Service Center, 1163 Upper Front Street, Binghamton, NY 13905	607-723-1384
Cattaraugus	Ellicottville Service Center, 8 Martha Street, Ellicottville, NY 14731	716-699-2375
Cayuga	Auburn Service Center, 7413 County House Road, Auburn, NY 13021	315-253-8471
Chautauqua	Jamestown Service Center, 3542 Turner Road, Jamestown, NY 14701	716-664-2351
Chemung/ Tioga	Waverly Service Center, 109A Chemung Street, Waverly, NY 14892	607-565-2106
Chenango	Norwich Service Center, 99 North Broad Street, Norwich, NY 13815	607-334-3231
Clinton/ Essex	Plattsburgh Service Center, 6064 State Route 22, Plattsburg, NY 12901	518-561-4616
Columbia/ Greene	Ghent Service Center, 1024 State Route 66, Ghent, NY 12075	518-828-4385
Cortland	Cortland Service Center, 100 Grange Place, Cortland, NY 13045	607-753-0851
Delaware	Walton Service Center, 44 West Street, Walton, NY 13856	607-865-4005
Dutchess/ Putnam/ Westchester	Millbrook Service Center, 2715 Route 44, Millbrook, NY 12545	845-677-3952
Erie	East Aurora Service Center, 50 Commerce Way, East Aurora, NY 14052	716-652-1400
Franklin	Malone Service Center, 151 Finney Boulevard, Malone, NY 12953	518-483-2850
Fulton/ Hamilton	Johnstown Service Center, 113 Hales Mills Road, Johnstown, NY 12095	518-762-0077
Genesee	Batavia Service Center, 29 Liberty Street, Batavia, NY 14020	585-343-9167
Herkimer	Herkimer Service Center, 5653 State Route 5, Herkimer, NY 13350	315-866-2520
Jefferson	Watertown Service Center, 21168 State Route 232, Watertown, NY 13601	315-782-7289
Lewis	Lowville Service Center, Outer Stowe Street, Lowville, NY 13367	315-376-7021
Livingston	Leicester Service Center, 129 Main Street, Leicester, NY 14481	585-382-3221
Madison	Morrisville Service Center, Farm & Home Center, Eaton Street, Morrisville, 13408	315-684-3321
Monroe	Rochester Service Center, 1200A Scottsville Rd, Suite 160, Rochester, NY 14624	585-473-2120
Montgomery	Fultonville Service Center, 4001 ST HWY 5 South, Fultonville, NY 12072	518-853-4015
Nassau/ Suffolk	Riverhead Service Center, 423 Griffing Avenue, Riverhead, NY 11901	631-727-2315
Niagara	Lockport Service Center, 4487 Lake Avenue, Lockport, NY 14094	716-433-6703
Oneida	Marcy Service Center, 9025 State Route 49, Marcy, NY 13403	315-736-3316
Onondaga	Lafayette Service Center, US Route 11, Lafayette, NY 13084	315-677-3552
Ontario	Canandaigua Service Center, 3037 County Road 10, Canandaigua, NY 14424	585-394-5970
Orange/ Rockland	Middletown Service Center, 225 Dolson Avenue , Middletown, NY 10940	845-343-1872
Orleans	Albion Service Center, 446 West Avenue, Albion, NY 14411	585-589-5320
Oswego	Mexico Service Center, 3306 Main Street, Mexico, NY 13114	315-963-0779
Otsego	Cooperstown Service Center, 967 County Route 33, Cooperstown, NY 13326	607-547-8131

Natural Resources Conservation Service Field Offices in NY (cont'd)

<u>COUNTY</u>	<u>OFFICE LOCATION</u>	<u>PHONE</u>
Rensselaer	Troy Service Center, 61 State St., Troy, NY 12180	518-271-1889
St. Lawrence	Canton Service Center, 3 Commerce Lane, Canton, NY 13617	315-386-2401
Saratoga	Ballston Spa Service Center, Municipal Ctr., 50 W High St., Ballston Spa, NY 12020	518-885-6300
Schenectady/ Schoharie	Cobleskill Service Center, 173 S Grand Street, Cobleskill, NY 12043	518-234-4377
Schuyler/ Tompkins	Ithaca Service Center, 903 Hanshaw Road, Ithaca, NY 14850	607-257-2737
Seneca	Seneca Falls Service Center, 12 N Park Street, Seneca Falls, NY 13148	315-568-6346
Steuben	Bath Service Center, 415 W Morris Street, Bath, NY 14810	607-776-7398
Sullivan	Liberty Service Center, 64 Ferndale-Loomis Road, Liberty, NY 12754	845-292-6471
Ulster	Highland Service Center, 652 State Route 299, Highland, NY 12528	845-883-7162
Warren/ Washington	Greenwich Service Center, 2530 State Route 40, Greenwich, NY 12834	518-692-9940
Wayne	Lyons Service Center, 10 Leach Road, Lyons, NY 14489	315-946-9912
Wyoming	Warsaw Service Center, 31 Duncan Street, Warsaw, NY 14569	585-786-3118
Yates	Penn Yan Service Center, 270 Lake Street, Penn Yan, NY 14527	315-536-4012

County Soil & Water Conservation District Offices in NY

<u>COUNTY</u>	<u>OFFICE LOCATION</u>	<u>PHONE</u>
Albany	Box 497, 24 Martin Road, Voorheesville, NY 12186	518-765-7923
Allegany	Ag Service Center, 5425 County Road 48, Belmont, NY 14813	585-268-7831
Broome	1163 Upper Front Street, Binghamton, NY 13905	607-724-9268
Cattaraugus	8 Martha Street, PO Box 1765, Ellicottville, NY 14731	716-699-2326
Cayuga	7413 County House Road, Auburn, NY 13021	315-252-4171
Chautauqua	Frank W. Bratt Ag Center, 3542 Turner Road, Jamestown, NY 14701	716-664-2355
Chemung	851 Chemung Street, Horseheads, NY 14845	607-739-2009
Chenango	99 North Broad Street, Norwich, NY 13815	607-334-4632
Clinton	6064 Route 22, Suite 1, Plattsburgh, NY 12901	518-561-4616
Columbia	1024 Route 66, Ghent, NY 12075	518-828-4386
Cortland	100 Grange Place, Room 204, Cortland, NY 13045	607-753-0851
Delaware	44 West Street, Suite 1, Walton, NY 13856	607-865-7161
Dutchess	2715 Route 44, Suite 3, Millbrook, NY 12545	845-677-8011
Erie	50 Commerce Way, East Aurora, NY 14052	716-652-8480
Essex	Cornell Cooperative Extension, P.O. Box 407, Westport, NY 12993	518-962-8225
Franklin	151 Finney Boulevard, Malone, NY 12953	518-483-4061
Fulton	113 Hales Mills Road, Johnstown, NY 12095	518-762-0077
Genesee	USDA Center, 29 Liberty Street, Suite #3, Batavia, NY 14020	585-343-2362
Greene	907 County Office Building, Cairo, NY 12413	518-622-3620
Hamilton	P.O. Box 166, Lake Pleasant, NY 12108	518-548-3991
Herkimer	5653 State Route 5, Herkimer, NY 13350	315-866-2520
Jefferson	P.O. Box 838, NYS Route 232, Watertown, NY 13601	315-782-2749
Lewis	P.O. Box 9, Lowville, NY 13367	315-376-6122
Livingston	129 Main Street, P.O. Box 152, Leicester, NY 14481	716-382-3214
Madison	Farm & Home Center, Eaton Street, P.O. Box 189, Morrisville, NY 13408	315-684-9577
Monroe	1200A Scottsville Road, Suite 160, Rochester, NY 14624	585-473-2120
Montgomery	4001 State Highway 5S, Fultonville, NY 12072	518-853-4015
Nassau	1425 Old Country Rd., Building J, Plainview, NY 11803	516-454-4872
New York City	290 Broadway, 24th floor, New York, NY 10007	212-637-3877
Niagara	USDA Service Center, 4487 Lake Avenue, Lockport, NY 14094	716-434-4949
Oneida	USDA Service Center, 9025 State Route 49, Room 204, Marcy, NY 13403	315-736-3334
Onondaga	2571 US Route 11, Suite #1, Lafayette, NY 13084	315-677-3851
Ontario	480 North Main Street, Canandaigua, NY 14424	585-396-1450
Orange	225 Dolson Avenue, Suite 103, Middletown, NY 10940	845-343-1873
Orleans	446 West Avenue, Albion, NY 14411	585-589-5959
Oswego	3095 State Route 3, Fulton, NY 13069	315-592-9663
Otsego	967 County Highway 33, Cooperstown, NY 13326	607-547-8337
Putnam	841 Fair Street, Carmel, NY 10512	845-878-7918
Rensselaer	County Ag. & Life Sciences Building, 61 State Street, Troy, NY 12180	518-271-1740
Rockland	50 Sanatorium Road, Building P, Pomona, NY 10970	845-364-2670
St. Lawrence	3 Commerce Lane, Canton, NY 13617	315-386-3582

County Soil & Water Conservation District Offices in NY (cont'd)

<u>COUNTY</u>	<u>OFFICE LOCATION</u>	<u>PHONE</u>
Saratoga	50 West High Street, Building #5, Ballston Spa, NY 12020	518-885-6900
Schenectady	24 Hetcheltown Road, Glenville, NY 12302	518-399-6980
Schoharie	173 South Grand Street, Room 11, Cobleskill, NY 12043	518-234-4092
Schuyler	Rural Urban Center, P.O. Box 326, 208 Broadway St., Montour Falls, NY 14865	607-535-9650
Seneca	12 North Park Street, Academy Square Building, Seneca Falls, NY 13148	315-568-4366
Steuben	USDA Service Center, 415 West Morris Street, Bath, NY 14810	607-776-7398
Suffolk	423 Griffing Avenue, Suite 110, Riverhead, NY 11901	631-727-2315
Sullivan	69 Ferndale-Loomis Road, Liberty, NY 12754	845-292-6552
Tioga	56 Main Street, Owego, NY 13827	607-687-3553
Tompkins	903 Hanshaw Road, Ithaca, NY 14850	607-257-2340
Ulster	Times Square Office Park, 652 Route 299, Suite 103, Highland, NY 12528	845-883-7162
Warren	51 Elm Street, Warrensburg, NY 12885	518-623-3119
Washington	USDA Service Center, 2530 State Route 40, Greenwich, NY 12834	518-692-9940
Wayne	10 Leach Road, Lyons, NY 14489	315-946-4136
Westchester	432 Michaelian Office Building, 148 Martine Avenue, White Plains, NY 10601	914-995-4422
Wyoming	31 Duncan Street, Warsaw, NY 14569	585-786-5070
Yates	417 Liberty Street, Penn Yan, NY 14527	315-536-5188

NYSDEC Division of Water Regional Contacts



DEC Region 6
 State Office Building
 207 Genesee Street
 Utica, NY 13501-2885
 Tel. (315) 793-2554

DEC Region 7
 615 Erie Blvd. West
 Syracuse, NY 13204-2400
 Tel. (315) 426-7500

DEC Region 5
 Hudson Street Extension
 Warrensburg, NY 12885-0220
 Tel. (518) 623-3671

DEC Region 4
 1150 North Westcott Road
 Schenectady, NY 12306-2014
 Tel. (518) 357-2045

DEC Region 3
 200 White Plains Road, 5th Floor
 Tarrytown, NY 10591-6805
 Tel. (914) 332-1835

DEC Region 1
 Bldg 40 - SUNY @ Stony Brook
 Stony Brook, NY 11790-2356
 Tel. (631) 444-0405

DEC Region 8
 6274 East Avon-Lima Rd.
 Avon, NY 14414-9519
 Tel. (585) 226-2466

DEC Region 9
 270 Michigan Ave.
 Buffalo, NY 14203-2999
 Tel. (716) 851-7070

DEC Region 2
 1 Hunters Point Plaza,
 47-40 21st St.
 Long Island City, NY 11101-5407
 Tel. (718) 482-4933

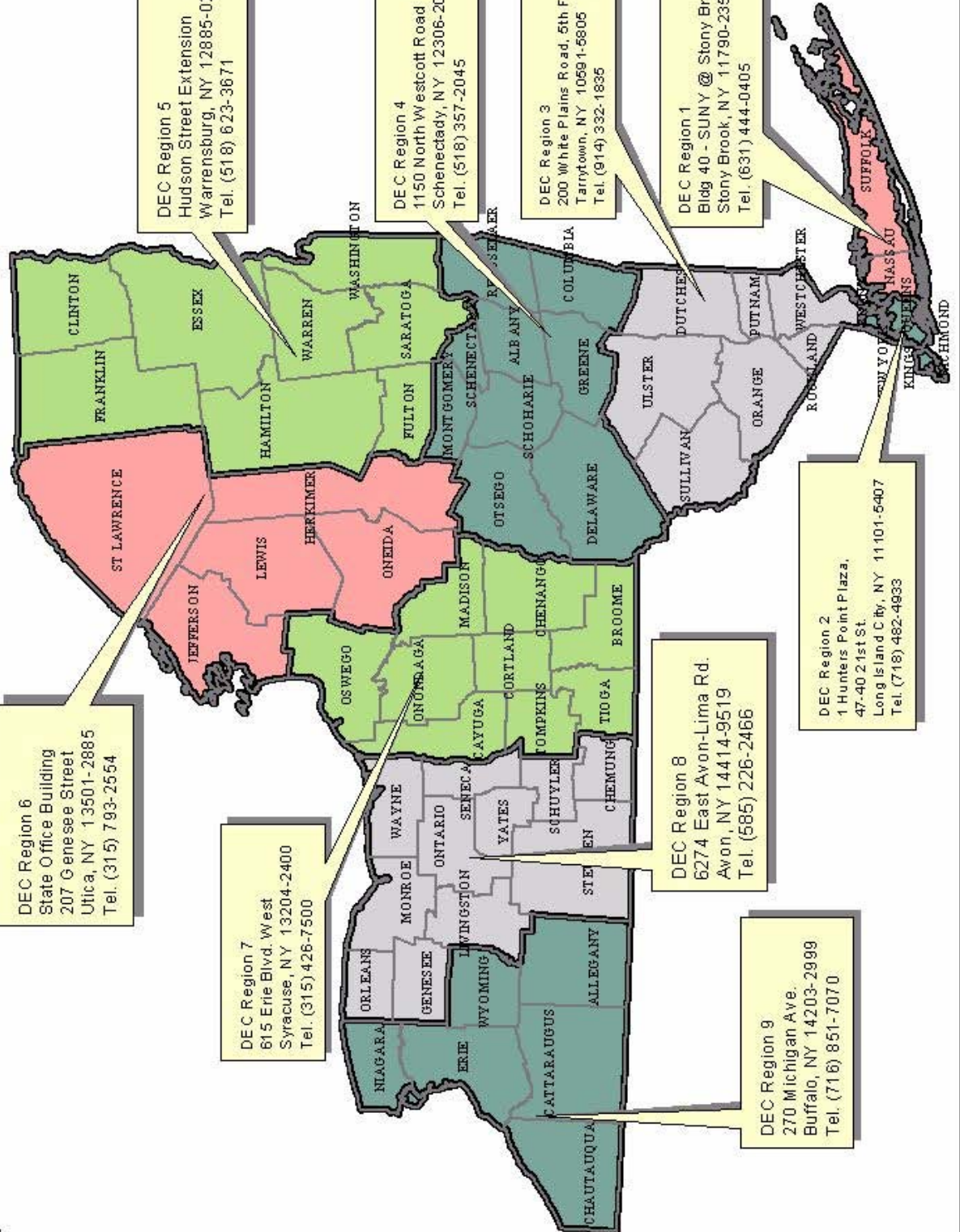

New York City Department of Environmental Protection

East of Hudson Engineering Office, Valhalla 914-773-0343
West of Hudson Engineering Office, Ashokam 845-657-5767

U.S. Army Corps of Engineers

Baltimore District 410-962-7608
Buffalo District 716-879-4209
Auburn Field Office 315-255-8090
New York District 212-264-0100
Troy Field Office 518-2700589
Philadelphia District 215-656-6728
Pittsburgh District 412-395-7154

Delaware River Basin Commission

609-883-9500

Susquehanna River Basin Commission

717-238-0423

Regional Planning Councils

Capital District Regional Planning Commission
One Park Place, Suite 102, Albany, NY 12205 518-453-0850
Central New York Regional Planning and Development Board
126 N. Salina Street, Suite 200, Syracuse, NY 13202 315-422-8276
Genesee/Finger Lakes Regional Planning Council
50 West Main Street, Suite 8107, Rochester, NY 14614 585-454-0190
Herkimer-Onieda Counties Comprehensive Planning Program
321 Main Street, Utica, NY 13501-1229 315-798-5710
Hudson Valley Regional Council
1010 D Street, New Windsor, NY 12553-8474 845-567-9466
Lake Champlain–Lake George Regional Planning and Development Board
P.O. Box 765, 310 Canada Street, Lake George, NY 12845 518-668-5773
Mohawk Valley Economic Development District
26 West Main Street, P. O. Box 69, Mohawk, NY 13407-0069 315-866-4671
Southern Tier Central Regional Planning and Development Board
145 Village Square, Painted Post, NY 14870 607-962-5092
Southern Tier East Regional Planning Development Board
375 State Street, Binghamton, NY 13901-2385 607-724-1327
Southern Tier West Regional Planning and Development Board
4039 Route 219, Suite 200, Salamanca, NY 14779 716-945-5301

County Cornell Cooperative Extension Offices in NY

<u>COUNTY</u>	<u>OFFICE LOCATION</u>	<u>PHONE</u>
Albany	PO Box 497, Voorheesville, NY 12186-0497	518-765-3500
Albany Regional	90 State Street, 6th Floor, Suite 600, Albany, NY 12207	518-462-2553
Allegany	5435A County Road 48, Belmont, NY 14813	716-268-7644
Broome	840 Upper Front Street, Binghamton, NY 13905-1542	607-772-8953
Cattaraugus	28 Parkside Drive, Suite A, Ellicottville, NY 14731	716-699-2377
Cayuga	248 Grant Avenue, Auburn, NY 13021-0167	315-255-1183
Chautauqua	3542 Turner Road, Jamestown, NY 14701-9608	716-664-9502
Chemung	425 Pennsylvania Avenue, Elmira, NY 14904-1793	607-734-4453
Chenango	99 North Broad Street, Norwich, NY 13815-1386	607-334-5841
Clinton	6064 Route 22, Plattsburgh, NY 12901-9601	518-561-7450
Columbia	479 NYS Route 66, Hudson, NY 12534-9706	518-828-3346
Cortland	60 Central Avenue, Room 105, Cortland, NY 13045-5590	607-753-5077
Delaware	PO Box 184, Hamden, NY 13782-0184	607-865-6531
Dutchess	Farm and Home Center, 2715 Route 44, Suite 1, Millbrook, NY 12545	845-677-8223
Erie	21 South Grove Street, East Aurora, NY 14052-2398	716-652-5400
Essex	PO Box 388, Westport, NY 12993-0388	518-962-4810
Franklin	63 West Main Street, Malone, NY 12953-1817	629-483-7403
Fulton	55 East Main Street, 2nd Floor, Suite 210, Johnstown, NY 12095	518-725-6441
Genesee	420 East Main Street, Batavia, NY 14020-2599	716-343-3040
Greene	HCR3, Box 906, Cairo, NY 12413-9503	518-622-9820
Hamilton	Box 7, NYS Route 8, Piseco, NY 12139	518-548-6191
Herkimer	5657 State Route 5, Herkimer, NY 13350-9721	315-866-7920
Jefferson	223 J.B. Wise Place, Watertown, NY 13601-2597	315-788-8450
Lewis	PO Box 72, Lowville, NY 13367	315-376-5270
Livingston	158 South Main Street, Mt. Morris, NY 14510-1595	716-658-3250
Madison	PO Box 1209, Morrisville, NY 13408-0640	315-684-3001
Monroe	249 Highland Avenue, Rochester, NY 14620	585 461-1000
Montgomery	55 East Main Street, 2nd Floor, Suite 210, Johnstown, NY 12095	518-853-3471
Nassau	1425 Old Country Road, Plainview, NY 11803-5015	516-454-0900
Niagara	4487 Lake Avenue, Lockport, NY 14094	716-433-6731
NYC	16 East 34th Street, 8th Floor, NY, NY 10016-4328	212-340-2900
Oneida	121 Second Street, Oriskany, NY 13424-9799	315-736-3394
Onondaga	220 Herald Place, 2nd Floor, Syracuse, NY 13202-1045	315-424-9485
Ontario	480 North Main Street, Canandaigua, NY 14424-1099	716-394-3977
Orange	1 Ashley Avenue, Education Ctr. Comm. Campus, Middletown, NY 10940	845-344-1234
Orleans	PO Box 150, Albion, NY 14411-0150	716-589-5561

County Cornell Cooperative Extension Offices in NY (cont'd)

<u>COUNTY</u>	<u>OFFICE LOCATION</u>	<u>PHONE</u>
Oswego	3288 Main Street, Mexico, NY 13114-3499	315-963-7286
Otsego	123 Lake Street, Cooperstown, NY 13326	607-547-2536
Putnam	10 Geneva Road, Brewster, NY 10509	845-278-6738
Rensselaer	61 State Street, Ag & Life Science Building, Troy, NY 12180	518-272-4210
Rockland	PO Box 1000, Thiells, NY 10984	845-429-7085
St. Lawrence	1894 State Highway 68, Canton, NY 13617-1477	315-379-9192
Saratoga	50 West High Street, Ballston Spa, NY 12020	518-885-8995
Schenectady	Schaffer Heights, 107 Nott Terrace, Suite 301, Schenectady, NY 12308	518-372-1622
Schoharie	41 South Grand Street, Cobleskill, NY 12043	518-234-4303
Schuyler	208 Broadway, Montour Falls, NY 14865	607-535-7161
Seneca	PO Box 748, Waterloo, NY 13165	315-539-9252
Steuben	3 East Pulteney Square, Bath, NY 14810	607-776-9631
Suffolk	246 Griffing Avenue, Riverhead, NY 11901-3086	631-727-7850
Sullivan	69 Ferndale-Loomis Road, Liberty, NY 12754-2903	845-292-6180
Tioga	56 Main Street, Owego, NY 13827-1588	607-687-4020
Tompkins	615 Willow Avenue, Ithaca, NY 14850-3555	607-272-2292
Ulster	10 Westbrook Lane, Kingston, NY 12401-2928	845-340-3990
Warren	377 Schroon River Rd, Warrensburg, NY 12885-4807	518-623-3291
Washington	Lower Main Street, Hudson Falls, NY 12839	518-746-2560
Wayne	1581 NYS Route 88N, Newark, NY 14513-9739	315-331-8415
Westchester	26 Legion Drive, Valhalla, NY 10595	914-285-4630
Wyoming	401 North Main Street, Warsaw, NY 14569	716-786-2251
Yates	110 Court Street, Penn Yan, NY 14527	315-536-5123

GLOSSARY

The list of terms that follows is representative of those used by soil conservationists, soil scientists, engineers, developers, contractors, planners, etc. The terms are in common use in conservation matters.

ACCESS ROAD- A road or vehicular travel way constructed to provide needed access to a site.

ACRE-FOOT- The volume of a substance, such as water, that will cover 1 acre to a depth of 1 foot.

AESTHETIC VALUE- The increase in value of a property derived from such intangible factors as its inherent attractiveness, its access to attractive views, or its general appeal to the sense of beauty of the owner or purchaser.

A-HORIZON- The organic material and leached minerals in the uppermost layer of soil.

AMORTIZATION- To repay a debt in a sequence of equal payments. Part of each payment is used to pay the interest due at the time it is made, and the balance is applied to the reduction of the principal.

ANGLE OF REPOSE- Angle between the horizontal and the maximum slope that a soil assumes through natural processes.

ANTECEDENT MOISTURE CONDITION (AMC)- The degree of wetness of a watershed at the beginning of a storm.

APRON- A floor or lining to protect a surface from erosion; for example, the pavement below chutes, spillways, or at the toes of dams.

ASSESSED VALUE- The value placed on property for taxation purposes.

ASSOCIATED COSTS- A term commonly used in water resource development projects. These costs include the value of goods and services needed over and above project costs to make the immediate products or services of a project available for use or sale.

BASE FLOW- The stream discharge from groundwater runoff.

BEDDING- The process of laying a drain or other conduit in its trench and tamping earth around the conduit to form its bed. The manner of bedding may be specified to conform to the earth load and conduit strength.

BEDLOAD- The sediment that moves by sliding, rolling, or bounding on or very near the streambed; sediment moved mainly by tractive or gravitational forces or both, but at velocities less than the surrounding flow.

B-HORIZON- The layer of soil below the A-horizon, sometimes referred to as the subsoil or zone of accumulation.

BENCH MARK (economics)- Data for a specific time period that is used as a base for comparative purposes with comparable data.

(engineering) – A point of reference in elevation surveys.

BERM- A shelf that breaks the continuity of a slope.

BLIND- Placement of loose soil around a tile or conduit to prevent damage or misalignment when the trench is backfilled. Allows water to flow more freely to the tile.

BLIND DRAIN- A type of drain consisting of an excavated trench refilled with pervious materials, such as coarse sand, gravel or crushed stone, where water percolates through the voids and flows toward an outlet. Often referred to as a French drain because of its initial development and widespread use in France.

BLIND INLET- Inlet to a drain in which entrance of water is by percolation rather than open flow channels.

BRUSH LAYERING- The embedment of green branches of shrub or tree species, perpendicular to the slope, on successive horizontal rows or contours.

BRUSH-MATTING- A blanket, or covering, of hardwood brush fastened down with stakes and wire.

cfs.- abbreviation for cubic feet per second. A unit of water flow.

CAPITAL RECOVERY PERIOD- The period of time required for the net returns from an outlay of capital to equal the investment.

CAPITALIZED COST- The first cost of an asset plus the present value of all renewals expected within the planning horizon.

CHANNEL – A natural stream that conveys water; a ditch or channel excavated for the flow of water.

CHANNEL IMPROVEMENT- The improvement of the flow characteristics of a channel by clearing, excavation, realignment, lining, or other means in order to increase its capacity. Sometimes used to connote channel stabilization.

CHANNEL STABILIZATION- Erosion prevention and stabilization of velocity distribution in a channel using jetties, drops, revetments, vegetation, and other measures.

COMPACTION- To unite firmly; the act or process of becoming compact, usually applied in geology to the changing of loose sediments into hard, firm rock. With respect to construction work with soils, engineering compaction is any process by which the soil grains are rearranged to decrease void space and bring them into closer contact with one another, thereby increasing the weight of solid material per cubic foot.

CONDUIT- Any channel intended for the conveyance of water, whether open or closed.

CONIFER- A tree belonging to the order of Coniferea, usually evergreen, with cones and needle-shaped or scale-like leaves and producing wood known commercially as “soft wood”.

CONSERVATION- The protection and improvement of natural resources.

CONSERVATION DISTRICT- A public organization created under state enabling law as a special purpose district to develop and carry out a program of soil, water, and related resource conservation, use, and development within its boundaries; usually a subdivision of state government with a local governing body and always with limited authorities. Often called a soil conservation district or a soil and water conservation district.

CONTOUR- 1. An imaginary line on the surface of the earth connecting points of the same elevation.

2. A line drawn on a map connecting points of the same elevation.

CONTOUR INTERVAL- The vertical distance between contour lines.

CONTOUR MAP- A map that shows the shape of the surface features of the ground by the use of contours.

CONTOUR WATTLING- The packing of lengths of bundles of twigs or tree whips into a continuous length, partially buried across a slope at regular contour intervals and supported on the downhill side by stakes.

CREST- 1. The top of a dam, dike, spillway, or weir, or other water barrier or control..

2. The summit of a wave or peak of a flood.

CRITICAL SITE- A sediment producing, highly erodible, or severely eroded area or site.

CRITICAL VELOCITY- Velocity at which a given discharge changes from tranquil to rapid flow; that velocity in open channels for which the specific energy (sum of the depth and velocity head) is a minimum for a given discharge.

CROSS-SECTION- A drawing that shows the features that would be exposed by a vertical cut through a man-made or natural structure or area.

CROWN (forestry)- The upper part of a tree, including the branches and foliage.

CUBIC FOOT PER SECOND- Rate of fluid flow at which 1 cubic foot of fluid passes a measuring point in 1 second. (Abbr. cfs.) (Syn. Second-foot; CUSEC.) See **cfs**.

CUT- Portion of land surface or area from which earth has been removed or will be removed by excavation; the depth below original ground surface to excavated surface.

CUT-AND-FILL- Process of earth moving by excavating part of an area and using the excavated material for adjacent embankment or fill areas.

CUTOFF- 1. Wall, collar, or other structure, such as a trench, filled with relatively impervious material intended to reduce seepage of water through porous strata.

2. In river hydraulics, the new and shorter channel formed either naturally or artificially when a stream cuts through the neck of a band.

DEBRIS DAM- A barrier built across a stream channel to retain rock, sand, gravel, silt, or other material.

DEBRIS GUARD- Screen or grate at the intake of a channel, drain, or pump structure for the purpose of preventing debris from entering.

DECIDUOUS PLANT- A plant that sheds all of its leaves every year at a certain season.

DEGRADATION- To wear down by erosion, especially through stream action.

DEPOSIT- Material left in a new position by a natural transporting agent, such as water, wind, ice, or gravity, or by the activity of man.

DESIGN STANDARDS- Standards of construction governing the size, shape, and relationship of spaces in any structure, which will control soil erosion and sedimentation.

DESIGN STORM- A given rainfall amount, areal distribution, and time distribution, used to estimate runoff. The rainfall amount is for a given frequency (25-year, 50-year, etc.).

DE-SILTING AREA- An area of grass, shrubs, or other vegetation used for inducing deposition of silt and other debris from flowing water, located about a stream, pond, field, or other area needing protection from sediment accumulation. See Filter Strip.

DETENTION DAM- A dam constructed for the purpose of temporary storage of stream flow or surface runoff and for releasing the stored water at controlled rates.

DIKE- An embankment to confine or control water, especially one built along the banks of a river to prevent overflow of lowlands; a levee.

DISCHARGE- Rate of flow, specifically fluid flow; a volume of fluid passing a point unit time, commonly expressed as cubic feet per second, million gallons per day, gallons per minutes, or cubic meters per second.

DISCHARGE FORMULA (hydraulics)- A formula to calculate rate of flow of fluid in a conduit or through an opening. For steady flow discharge, $Q=AV$, wherein Q is rate of flow, A is cross sectional area, and V is mean velocity. Common units are: Q = cubic feet per second, A = square feet, and V = feet per second, respectively. To calculate the mean velocity, V , for uniform flow in pipes or open channels, see Manning's formula.

DIVERSION- Channel constructed across the slope for the purpose of intercepting surface runoff; changing the accustomed course of all or part of the surface water drainage path. See Terrace.

DIVERSION TERRACE- Diversions, which differ from terraces in that they consist of individually designed channels across a hillside; may be used to protect bottomland from hillside runoff or may be needed above a terrace system for protection against runoff from an un-terraced area. They may also divert water out of active gullies, protect farm buildings from runoff, reduce the number of waterways, and are sometimes used in connection with strip cropping to shorten the length of slope so that the strips can effectively control erosion. See Terrace.

DRAINAGE- The removal of excess surface water or groundwater from land by means of surface or subsurface drains.

DRAINAGE AREA- The area draining into a stream at a given point. The area may be of different sizes for surface runoff, subsurface flow and base flow, but generally the surface runoff area is used as the drainage area. See watershed.

DRAINAGE DISTRICT- A cooperative, self-governing public corporation created under state law to finance, construct, operate, and maintain a drainage system involving a group or land holding.

DROP-INLET SPILLWAY- Overfall structure in which the water drops through a vertical riser connected to a discharge conduit.

DROP SPILLWAY- Overfall structure in which the water drops over a vertical wall onto an apron at a lower elevation.

DROP STRUCTURE- A structure for dropping water to a lower level and dissipating surplus energy; a fall. A drop may be vertical or inclined.

EFFLUENT- 1. The discharge or outflow of water from ground or subsurface storage.

2. The fluids discharged from domestic, industrial, and municipal waste collection systems or treatment facilities.

ERODIBILITY (OF SOIL)- The 'K' value in RUSLE expresses the average long-term soil and soil profile response to the erosive powers of rain storms.

EROSION- The wearing away of the land surface by running water, wind, ice, or other geological agents, including such processes as gravitational creep.

a. **GULLY EROSION-** The erosion process whereby water accumulates in narrow channels and, over short periods, removes the soil from this narrow area to considerable depths, ranging from 1 to 2 feet to as much as 75 to 100 feet.

b. **RILL EROSION-** An erosion process in which numerous small channels only a few inches deep are formed; occurs mainly on recently cultivated soils. See Rill.

c. **SHEET EROSION-** The removal of a fairly thin, uniform layer of soil from the land surface by runoff water.

EROSIVITY (OF SOIL)- The 'R' value in RUSLE expresses the interrelationships of the raindrop energy times the 30-minute rainfall intensity.

EUTROPHICATION- A means of aging lakes whereby aquatic plants are abundant and waters are deficient in oxygen. The process is usually accelerated by enrichment of waters with surface runoff containing nitrogen and phosphorus.

EVAPOTRANSPIRATION (ET)- Plant transpiration plus evaporation from the soil. Difficult to determine separately, therefore used together as a unit for study.

FALLOW- Cropland plowed, but not seeded during one or more growing seasons; cropland left idle may be a normal part of the cropping system for weed control, water conservation, soil conditioning, etc.

FILTER STRIP- Strip of permanent vegetation designed to retard flow of runoff water, causing deposition of transported material, thereby reducing sediment flow. See **Desilting Area**.

FINISHED GRADE- The final grade or elevation of the ground surface conforming to the approved grading plan.

FLOOD FRINGE- That portion of the floodplain subject only to shallow inundation and low velocity flow of flooding water.

FLOODPLAIN- Normally dry land areas subject to periodic, temporary inundation by stream flow or tidal overflow. Land formed by deposition of sediment by water; alluvial land.

FLOODPLAIN MANAGEMENT- The wise use of floodplains so as to reduce human suffering, property damage, and habitat loss resulting from floods and to lessen the need for expensive flood control structures, such as dams and reservoirs.

FLOODWAY- That portion of the floodplain required to store and discharge floodwaters without causing significant damaging, or potentially damaging, increases in flood heights and velocities.

FREEBOARD (hydraulics)- Vertical distance between the maximum water surface elevation anticipated in design and the top of restraining banks or structures provided to prevent overtopping because of unforeseen conditions.

FREQUENCY- An expression or measure of how often a hydrologic event of given size or magnitude should, on the average, be equaled or exceeded. For example, a 50-year frequency flood should be equaled or exceeded in size, on the average, only once in 50 years. In drought or deficiency studies, it usually defines how many years will, on the average, be equal to or less than a given size or magnitude.

FUNCTIONAL PLAN- A plan for one element, or closely related elements of a comprehensive plan, for example, transportation, recreation, and open spaces. Such plans, of necessity, should be closely related to the land use plan. Plans that fall short of considering all elements of a comprehensive plan may be considered as functional plans. Thus, resource conservation and development plans and watershed project plans should be considered as functional plans.

GABION- A galvanized wire basket filled with stone used for structural purposes. When fastened together, gabions are used as retaining walls, revetments, slope protection and similar structures.

GRADE STABILIZATION STRUCTURE- A structure for the purpose of stabilizing the grade of a gully or other watercourse, thereby preventing further head-cutting or lowering of the channel grade.

GRASSED WATERWAY- A natural or constructed waterway, usually broad and shallow, covered with erosion resistant grasses, used to conduct surface water; can reduce velocity and filter water.

GRAVEL ENVELOPE- Selected aggregate placed around the screened pipe section of well casing or a subsurface drain to facilitate the entry of water into the well or drain.

GRAVEL FILTER- Graded sand and gravel aggregate placed around a drain or well screen to prevent the movement of fine materials from the aquifer into the drain or well.

GRUBBING- The removal of stumps and root material from the soil mantle.

GULLY- A channel or miniature valley cut by concentrated runoff but through which water commonly flows only during and immediately after heavy rains or during the melting of snow. A gully may be dendritic or branching or it may be linear, rather long, narrow, and of uniform width. The distinction between gully and rill is one of depth. A gully is sufficiently deep that it would not be obliterated by normal tillage operations, whereas a rill is of lesser depth and would be smothered by ordinary tillage or low impact grading.

HARDPAN- A hardened soil layer in the lower A or in the B horizon caused by cementation of soil particles with organic matter, or with materials such as silica, sesquioxides, or calcium carbonate. The hardness does not change appreciably with changes in moisture content, and pieces of the hard layer do not slake in water.

HIGHWAY EROSION CONTROL- The prevention and control of erosion in ditches, at cross drains, and on fills and road banks within a highway right-of-way. Includes vegetative practices and structural practices.

HOOD INLET- Entrance to a closed conduit that has been shaped to induce full flow at minimum water surface elevation.

HORIZONS, MINERAL SOIL-

A horizons are surface layers

B horizons are subsoil horizons ¹. They are designated as follows:

B alone indicates some residual transformation or change in place, such as color.

Bt indicates accumulations of translocated clay. Bx indicates a B horizon with fragipan characteristics such as firmness, brittleness and high density.

C horizons are substrata layer ¹; they consist of mineral material like or unlike the material from which the A & B horizons have formed and have been little affected by soil forming process. They are designated as follows:

C alone indicates material like the material from which the A & B horizons have formed.

Cx indicates a C horizon of material like that of the A & B horizons but has the firm, brittle and dense characteristics of a fragipan.

¹ Roman numerals are prefixed to the appropriate horizon designations such as IIB, IIBt, IIBx, and IIC or IICx when it is necessary to number a series of layers of unlike or contrasting material from the surface downward. Claverack is an example in which the A & B horizons have formed in sand and the underlying material is contrasting silty clay that is indicated as a IIC horizon.

HYDRAULIC GRADE LINE- In a closed conduit, a line joining the elevations to which water could stand in risers of vertical pipes connected to the conduit at their lower end and open at their upper end. In open channel flow, the hydraulic grade line is the free water surface.

HYDROGRAPH- A graph showing stage, flow, velocity, or other property of water with respect to time.

HYDROLOGIC SOIL COVER COMPLEX- A combination of a hydrologic soil group and a type of cover.

HYDROLOGIC SOIL GROUP- A group of soils having the same runoff potential under similar storm and cover conditions.

HYDROLOGY- The science that deals with the occurrence and movement of water in the atmosphere, upon the surface, and beneath the land areas of the earth. Rainfall intensities, rainfall interception by trees, effects of crop rotation on runoff, floods, droughts and the flow of springs and wells, are some of the topics studied by a hydrologist.

HYDROSEEDING- The dissemination of seed hydraulically in a liquid medium; mulch, lime, and fertilizer can be incorporated into the sprayed mixture.

IMPERVIOUS SOIL- A soil through which water, air or roots cannot penetrate. No soil is impervious to water and air without significant impact or compaction.

IMPOUNDMENT- Generally, an artificial collection or storage of water, as a reservoir, pit, dugout, sump, etc.

INDUSTRIAL PARK- A tract of land, the control and administration of which are vested in a single body, suitable for industrial use because of location, topography, proper zoning, availability of utilities, and accessibility to transportation.

INFILTRATION- Rainfall minus interception, evaporation, and surface runoff. The part of rainfall that enters the soil.

INFILTRATION RATE- A soil characteristic determining or describing the maximum rate at which water can enter the soil under specified conditions, including the presence of an excess of water.

INITIAL ABSTRACTION (I_a)- When considering surface runoff, I_a is all the rainfall before runoff begins. When considering direct runoff, I_a consists of interception, evaporation and the soil-water storage that must be exhausted before direct runoff may begin.

INOCULATION (OF SEEDS)- The addition of nitrogen fixing bacteria (inoculant) to legume seeds or to the soil in which the seeds are to be planted; the bacteria take free nitrogen from the air and make it available to the seeds.

INTERCEPTION- Precipitation retained on plant or plant residue surfaces and finally absorbed, evaporated, or sublimated. That which flows down the plant to the ground is called “stem flow” and not counted as true interception.

INTERMITTENT STREAM- A stream, or portion of a stream, that flows only in direct response to precipitation. It receives little or no water from springs and no long term continued supply from melting snow or other sources. The stream, or channel, is dry for some part of the year, usually during the dry months.

ISO-ERODENT VALUE- A term used to correlate areas of equally erosive average annual rainfall.

LANDSCAPE- All the natural features, such as fields, hills, forests, water, etc., that distinguish one part of the earth's surface from another part, usually that portion of land or territory which the eye can comprehend in a single view, including all of its natural characteristics.

LIME, AGRICULTURAL- A soil amendment consisting principally of calcium carbonate, but including magnesium carbonate and perhaps other materials, used to furnish calcium and magnesium as essential elements for the growth of plants and to neutralize soil acidity.

LINING- A protective covering over all or part of the perimeter of a reservoir or a conduit to prevent seepage losses, withstand pressure, resist erosion, and reduce friction or otherwise improve conditions of flow.

LIVE STAKING- Utilizing vegetative cover for the control of erosion and shallow sliding by means of willow or poplar cuttings that root easily and grow rapidly under certain conditions.

MANNING'S FORMULA (hydraulics)- A formula used to predict the velocity of water flow in an open channel or pipeline:

$$V=[(1.486) (r^{2/3})(s^{1/2})]/n$$

Where:

V= the mean velocity of flow in feet per second;

r=the hydraulic radius;

s=the slope of energy gradient or, for assumed uniform flow, the slope of the channel in feet per foot; and

n=the roughness coefficient or retardance factor of the channel lining.

MUCK SOIL- 1. An organic soil in which the organic matter is well decomposed (USA usage).

2. A soil containing 20 to 50 percent organic matter.

MULCH- A natural or artificial layer of plant residue or other materials, such as sand or paper, on the soil surface.

NETTING- Plastic, paper, cotton, or other material used to hold mulch on the soil surface.

OUTLET- Point of water disposal from a stream, river, lake, tidewater, or artificial drain.

PARTICLE SIZE CLASSES FOR FAMILY

GROUPINGS (as used in the Soil Classification System of the National Cooperative Soil Survey in the United States)- Various particle size classes are applied to arbitrary control sections that vary according to the depth of the soil, presence or absence of argillic horizons, depth to paralithic or lithic contacts, fragipans, horizons. No single set of particle size classes is appropriate as a family grouping for all kinds of soil. The classification tabulated below provides a choice of several particle size classes.

1. Sandy-Skeletal- More than 35 percent, by volume, coarser than 2 millimeters, with enough fines to fill interstices larger than 1 millimeter; fraction less than 2 millimeters is as defined for the sandy class.
2. Loamy-Skeletal- More than 35 percent, by volume, coarser than 2 millimeters, with enough fines to fill interstices larger than 1 millimeter; fraction less than 2 millimeters is as defined for loamy classes.
3. Sandy- Sands, except very fine sand, and loamy sands, except loamy very fine sand.
- 4a. Coarse-Loamy- With less than 18 percent clay and more than 15 percent coarser than very fine sand (including coarse fragments up to 7.5 centimeters).
- b. Fine-Loamy- With more than 18 percent clay but less than 35 percent clay and more than 15 percent coarser than very fine sand (including coarse fragments up to 7.5 centimeters).
- c. Coarse-Silty- With less than 18 percent clay and less than 15 percent coarser than very fine sand (including coarse fragments up to 7.5 centimeters).
- d. Fine-Silty- With more than 18 percent clay and less than 35 percent clay and less than 15 percent coarser than very fine sand (including coarse fragments up to 7.5 centimeters).
- 5a. Fine- With more than 35 percent clay but less than 60 percent clay.
- b. Very-Fine- With more than 60 percent clay.

PEAK FLOW- The maximum instantaneous flow of water from a given storm condition at a specific location.

PEAT- Dark brown residual material produced by the partial decomposition and disintegration of plants that grow in wet places.

PERMEABILITY- The quality of a soil horizon that enables water or air to move through it. Terms used to describe permeability are as follows: very slow, slow, moderately slow, moderate, moderately rapid, rapid, and very rapid.

pH- A numerical measure of the acidity or alkalinity of a soil; neutral soil has a pH of 7; all pH values below 7 are acid, and all above 7 are alkaline.

PLANNED UNIT DEVELOPMENT- A zoning classification permitting flexibility of site design by combining building types and uses in ways that would be prohibited by traditional zoning standards.

PLAT OF SURVEY- A scaled drawing identifying a parcel of real estate, prepared by a registered surveyor, including a legal description of the property and the dimensions of the physical improvements.

RAINFALL INTENSITY- The rate at which rain is falling at any given instant, usually expressed in inches per hour.

RECP- Rolled erosion control products. These are manufactured rolls of material used to protect slopes and/or waterways by resisting flow and aiding vegetation.

RETARDANCE (vegetation)- The characteristic of the vegetative lining of a channel that tends to restrict and impede flow relative to a perfectly smooth channel.

RETURN FLOW- That portion of the water diverted from a stream which finds its way back to the stream channel either as surface or underground flow.

REVETMENT- Facing of stone or other material, either permanent or temporary, placed along the edge of a stream to stabilize the bank and to protect it from the erosive action of the stream.

RIPARIAN RIGHTS- The rights of an owner whose land abuts water. They differ from state to state and often depend on whether the water is a river, lake or ocean. See Water Rights.

RIPRAP- Broken rock, cobbles, or boulders placed on earth surfaces, such as the face of a dam or the bank of a stream, for protection against the action of water (waves); also applied to brush or pole mattresses, or brush and stone, or other similar materials used for soil erosion control.

RUNOFF- That portion of the precipitation on a drainage area that is discharged from the area in stream channels. Types include surface runoff, groundwater runoff, or seepage.

RUNOFF CURVE NUMBER (CN)- A parameter combining the effects of soils, watershed characteristics, and land use. This parameter represents the hydrologic soil cover complex of the watershed.

RUSLE- Abbreviation for Revised Universal Soil Loss Equation; used to estimate sheet and rill soil loss on potentially erosive sites.

SCALPING- Removal of sod or other vegetation in spots or strips.

SCARIFY- To abrade, scratch, or modify the surface; for example, to scratch the impervious seed coat of hard seed or to break the surface of the soil with a narrow-bladed implement.

SEDIMENT- Solid material, both mineral and organic, that is in suspension, is being transported, or has been moved from its site of origin by air, water, gravity, or ice and has come to rest on the earth's surface either above or below sea level.

SEDIMENT BASIN- A basin or pond designed to store a calculated amount of sediment being transported on a site.

SEDIMENT DISCHARGE- The quantity of sediment, measured in dry weight or by volume, transported through a stream cross-section in a given time. Sediment discharge consists of both suspended load and bedload.

SEEDBED- The soil prepared by natural or artificial means to promote the germination of seed and the growth of seedlings.

SEEPAGE- 1. Water escaping through, or emerging from, the ground along an extensive line or surface, as contrasted with a spring where the water emerges from a localized spot.

2. The process by which water percolates through the soil.

3. (percolation) The slow movement of gravitational water through the soil.

SETTLING BASIN- An enlargement in the channel of a stream to permit the settling of debris carried in suspension.

SHRINK-SWELL POTENTIAL- The susceptibility of soil to volume change due to loss or gain in moisture content.

SHRUB- A woody perennial plant differing from a perennial herb by its more woody stems and from a tree by its low stature and habit of branching from the base. There is no definite line between herbs and shrubs or between shrubs and trees; all possible intergradations occur.

SIDE SLOPES (engineering)- The slope of the sides of a canal, dam, or embankment. It is customary to name the horizontal distance first, as 1.5 to 1, or frequently, 1-1/2:1, meaning a horizontal distance of 1.5 feet to 1 foot vertical.

SITE ANALYSIS- Evaluation of the qualities and drawbacks of a site by comparison with those aspects of other comparable sites.

SOIL EROSION AND SEDIMENT CONTROL PLAN-

A plan which fully indicates the necessary land protection and structural measures, including a schedule of the timing of their installation, which will effectively minimize soil erosion and sediment yields.

SOIL STRUCTURE- The arrangement of primary soil particles into compound particles or clusters that are separated from adjoining aggregates and have properties unlike those of an equal mass of unaggregated soil particles. The principal forms of soil structure are: platy (laminated), prismatic (vertical axis of aggregates longer than horizontal), columnar (prisms with rounded tops), blocky (angular or subangular), and granular. Structureless soils are: (1) single grain (each grain by itself, as in dune sand), or (2) massive (the particles adhering together without any regular cleavage, as in many claypans and hardpans).

SOIL SURVEY- Survey showing soil type and composition.

SOIL TEXTURE- The relative proportions of the various soil separates in a soil as described by the classes of soil texture shown in Figure 1. The textural classes may be modified by the addition of suitable adjectives when coarse fragments are present in substantial amounts; for example, gravelly silt loam. (For other modifications, see coarse fragments). Sand, loamy sand, and sandy loam are further subdivided on the basis of the proportions of the various soil separates present.

SPILLWAY- An open or closed channel, or both, used to convey excess water from a reservoir. It may contain gates, either manually or automatically controlled, to regulate the discharge of excess water.

SPOIL- Soil or rock material excavated from a canal, basin, or similar construction.

STAGE (hydraulics)- The variable water surface or the water surface elevation above any chosen datum.

STATE SOIL AND WATER CONSERVATION COMMITTEE, COMMISSION, OR BOARD- The state agency established by state soil conservation districts, enabling legislation to assist with the administration of the provisions of the state soil conservation districts law. The official title may vary from the above as new, or amended, state laws are made.

STILLING BASIN- An open structure or excavation at the foot of an overfall, chute, drop, or spillway to reduce the energy of the descending stream.

STREAMBANKS- The usual boundaries, not the flood boundaries, of a stream channel. Right and left banks are named facing downstream.

STRATA CAPACITY- The maximum amount of material a stream is able to transport.

STREAM LOAD- Quantity of solid and dissolved material carried by a stream. See Sediment Load.

STORMWATER MANAGEMENT- Runoff water safely conveyed or temporarily stored and released at an allowable rate to minimize erosion and flooding.

STRIPPING- Denuding vacant or untouched land of its present vegetative cover and topsoil.

SUBGRADE- The soil prepared and compacted to support a structure or a pavement system.

SUBSOIL- The B horizons of soils with distinct profiles. In soils with weak profile development, the subsoil can be defined as the soil below the plowed soil (or its equivalent of surface soil), in which roots normally grow. Although a common term, it cannot be defined accurately.

SUMP- Pit, tank, or reservoir in which water is collected for withdrawal or stored.

SUSPENDED LOAD- The fine sediment kept in suspension in a stream because the settling velocity is lower than the upward velocity of the current.

SWALE- A linear, but flattish depression in the ground surface which conveys drainage water but offers no impediment to traffic, as do ditches or gutters.

TERRACE- An embankment or combination of an embankment and channel constructed across a slope to control erosion by diverting or storing surface runoff instead of permitting it to flow uninterrupted down the slope. Terraces or terrace systems may be classified by their alignment, gradient, outlet, and cross-section. Alignment is parallel or non-parallel. Gradient may be level, uniformly graded, or variably graded. Grade is often incorporated to permit paralleling the terraces. Outlets may be soil infiltration only, vegetated waterways, tile outlets, or combinations of these. Cross-sections may be narrow base, broad base, bench, steep backslope, flat channel, or channel.

TIME OF CONCENTRATION- Time required for water to flow from the most remote point of a watershed, in a hydraulic sense, to a specific point, usually the outlet.

TIMING SCHEDULE- A construction progress schedule showing the proposed dates of commencement and completion of each of the various subdivisions of work as shown and called for in the approved plans and specifications.

TOPOGRAPHIC MAP- A schematic drawing of prominent landforms indicated by conventional symbols such as hachures or contour lines.

TOPSOIL- The uppermost layers of soil containing organic material and suited for plant survival and growth.

TRAP EFFICIENCY- The capability of a reservoir to trap sediment.

TRAVEL TIME- The time for water to travel from one location to another in a watershed. Travel time is a component of time of concentration (T_c).

TRIBUTARY- Secondary, or branch of a stream, drain, or other channel that contributes flow to the primary or main channel.

TRM- Turf reinforcement mat. These are typically non-biodegradable mats with depth, which aid in stabilizing waterways by providing strength to vegetative root systems.

UNIFIED SOIL CLASSIFICATION SYSTEM (engineering)- A classification system based on the identification of soils according to their particle size, gradation, plasticity index, and liquid unit.

UNIT HYDROGRAPH- A discharge hydrograph coming from one inch of direct runoff distributed uniformly over the watershed, with the direct runoff generated at a uniform rate during the given storm duration. A watershed may have 1-hour, 2-hour, etc. unit hydrographs.

WATER QUALITY STANDARDS- Minimum requirements of purity of water for various uses; for example, water for agricultural use in irrigation systems should not exceed specific levels of sodium bicarbonates, pH, total dissolved salts, etc.

WATER RIGHTS- The legal rights to the use of water. They consist of riparian rights and those acquired by appropriation and prescription. Riparian rights are those rights to use and control water by virtue of ownership of the bank or banks. Appropriated rights are those acquired by an individual to the exclusive use of water, based strictly on priority of appropriation and application of the water to beneficial use and without limitation of the place of use to riparian land. Prescribed rights are those to which legal title is acquired by long possession and use without protest of other parties.

WATERSHED- The area contributing direct runoff to a stream. Usually it is assumed that base flow in the stream also comes from the same area. However, the ground water watershed may be larger or smaller.

WATERTABLE- The upper surface of groundwater or that level below which the soil is saturated with water; locus of points in soil water at which the hydraulic pressure is equal to atmospheric pressure.

WATERWAY- A natural course or constructed channel for the flow of water.

WATTLE- A group or bundle of twigs, whips, or witches.

WEEP-HOLES (engineering)- Openings, left in retaining walls, aprons, linings, or foundations to permit drainage and reduce pressure.

ZONING (rural)- A means by which governmental authority is used to promote the proper use of land under certain circumstances. This power traditionally resides in the state; and the power to regulate land uses by zoning is usually delegated to minor units of government, such as towns, municipalities, and counties, through an enabling act that specifies powers granted and the conditions under which these are to be exercised.

ZONING ORDINANCE- The exercise of police power for the purpose of carrying out the land use plan of an area. It may also include regulations to effect control of the size and height of buildings, population density, and use of buildings; for example, residential, commercial, industrial, etc.

Page Intentionally Left Blank